

**Zoning Board of Appeals  
March 28, 2018 Regular Meeting**

**STAFF REPORT**

**Subject: ZBA 18-009; 403 West Liberty Street**

**Summary:**

Carl O. Hueter AIA, representing the property owner, is requesting a variance from Chapter 55 Section 5:34 (Area, Height and Placement Regulations). A 137 square foot variance from the required 8,500 square foot lot size requirement in the R4C is being requested. The size of the lot is 8,363 square feet. The proposed ten (10) bedroom rooming house is being converted to a six (6) bedroom duplex.

**Background:**

The subject parcel is zoned R4C (multiple family) and is located on a corner lot at the intersection of West Liberty and Second Street. The home was built in the 1880's and is approximately 2,060 square feet in size. The property is in the Old West Side historic district and received approval from the Historic District Commission (HDC) in January to construct a new carport and complete restoration work to the main residence.

**Description:**

The owner desires to convert this former grand single family residential property from its current ten (10) bedroom rental rooming house to a two (2) unit duplex. The proposed units would be a lower level (walk-out basement) two (2) bedroom unit apartment and the first, second and third floors as a four bedroom townhouse unit. The conversion would reduce the number of bedrooms (and occupants) from ten (10) to six (6).

**Standards for Approval- Variance**

The Zoning Board of Appeals has all the power granted by State law and by Section 5:99, Application of the Variance Power from the City of Ann Arbor Zoning Ordinance. The following criteria shall apply:

- (a). That the alleged hardships or practical difficulties, or both, are exceptional and peculiar to the property of the person requesting the variance, and result from conditions which do not exist generally throughout the city.***

The applicant states that the non-conforming conditions being requested for relief are unique to this property being that the site pre-dates the current zoning requirements for lot size and front setbacks for the R4C zoning district standards. The proposed changes only affect the interior of the structure in room configurations and occupancy.

- (b). That the alleged hardships are practical difficulties, or both, which will result from a failure to grant the variance, include substantially more than mere inconvenience, inability to attain a higher financial return or both.**

The request to allow the internal conversion of the existing ten (10) bedroom rooming house to a two (2) bedroom and a four (4) bedroom duplex would provide a more compatible unit mix to the neighborhood, rather than a large six (6) bedroom single family rental.

- (c). That allowing the variance will result in substantial justice being done, considering the public benefits intended to be secured by this Chapter, the individual hardships that will be suffered by a failure of the Board to grant a variance, and the rights of others whose property would be affected by the allowance of the variance.**

The applicant states that the granting of the variances will allow the building to be restored to its original historic character which will enhance the Old West Side Historic District. The rooming house which is viewed as a less desirable use will also be eliminated and provide for two (2) additional dwelling units in close proximity to the Downtown.

- (d). That the conditions and circumstances on which the variance request is based shall not be a self-imposed hardship or practical difficulty.**

The noted requests are for issues regarding the property which are existing and predate those imposed by the zoning district applied by the City and not the property owner.

- (e). A variance approved shall be the minimum variance that will make possible a reasonable use of the land or structure.**

The applicants feel that the overall improvements to the exterior of the home and property that were granted by the HDC are minimal and will not have any negative impacts on the surrounding properties.

Respectfully submitted,

A handwritten signature in blue ink, appearing to read "Jon Barrett". The signature is stylized with large loops and a cursive script.

**Jon Barrett  
Zoning Coordinator**

403 W Liberty St

W Washington St

Krause St

Alley

W Liberty St

W William St

Fourth St

Third St

Second St

S First St

 Railroads

 Huron River

 Tax Parcels



Map date 3/6/2018  
Any aerial imagery is circa 2015  
unless otherwise noted  
Terms of use: [www.a2gov.org/terms](http://www.a2gov.org/terms)





# 403 W Liberty St



-  Railroads
-  Huron River
-  Tax Parcels





Map date 3/6/2018  
Any aerial imagery is circa 2015  
unless otherwise noted  
Terms of use: [www.a2gov.org/terms](http://www.a2gov.org/terms)



403 W Liberty St



 Railroads  
 Huron River  
 Tax Parcels



Map date 3/6/2018  
Any aerial imagery is circa 2015  
unless otherwise noted  
Terms of use: [www.a2gov.org/terms](http://www.a2gov.org/terms)





**ZONING BOARD OF APPEALS  
PLANNING DEPARTMENT**

City Hall: 301 E. Huron St. Ann Arbor, MI 48104-6120  
 Mailing: P.O. Box 8647, Ann Arbor, MI 48107-8647  
 Phone: 734.794.6265 [planning@a2gov.org](mailto:planning@a2gov.org)  
 Fax: 734.994.8460

**APPLICATION MUST BE FILLED OUT COMPLETELY**

Office Use Only	
Fee Paid: _____	ZBA: _____
<b>DATE STAMP</b>	

**PROPERTY INFORMATION**

ADDRESS OF PROPERTY: <b>403 WEST LIBERTY</b>	
ZONING CLASSIFICATION: <b>R4C</b>	TAX ID: (if known) <b>09-09-19-302-057</b>
NAME OF PROPERTY OWNER*: <b>403 WEST LIBERTY LLC</b>	

*\*If different than applicant, a letter of authorization from the property owner must be provided*

**APPLICANT INFORMATION**

NAME OF APPLICANT: <b>CARL O. HUETER A.I.A.</b>	
ADDRESS OF APPLICANT: <b>1321 FRANKLIN BLVD. #2, MI. 48103-5802</b>	
DAYTIME PHONE NUMBER: <b>734-270-8175</b>	FAX NO: <b>NONE</b>
EMAIL: <b>carl@hueterarchitects.com</b>	
APPLICANT'S RELATIONSHIP TO PROPERTY: <b>architect</b>	

**REQUEST INFORMATION**

<input checked="" type="checkbox"/> VARIANCE REQUEST (Complete the section 1 below)	<input type="checkbox"/> ALTERATION TO A NON-CONFORMING STRUCTURE (skip to Section 2)
---	---

**Section 1 - VARIANCE REQUEST**

CHAPTER(S) AND SECTION(S) FROM WHICH A VARIANCE IS REQUESTED: (Example: Chapter 55, Section 5:26) <b>CHAPTER 55, ARTICLE III, 5:24 R4C FOR MIN. LOT SIZE &amp; FRONT YARD SETBACK</b>	
Required Dimension: (Example: 40' front setback) <b>SITE AREA: 8,500 SF</b>	PROPOSED Dimension: (Example: 32') <b>8,107 SF</b>
Give a detailed description of the work you are proposing and why it will require a variance (Attach additional sheets if necessary) <b>CONVERSION OF EXISTING 10 ROOM ROOMING HOUSE INTO A DUPLEX CONTAINING A 2 BR &amp; 4 BR DWELLING UNIT.</b>	





# ZONING BOARD OF APPEALS

## PLANNING DEPARTMENT

City Hall: 301 E. Huron St. Ann Arbor, MI 48104-6120

Mailing: P.O. Box 8647, Ann Arbor, MI 48107-8647

Phone: 734.794.6265

Fax: 734.994.8460

[planning@a2gov.org](mailto:planning@a2gov.org)

### Section 1 - VARIANCE REQUEST con't

The City of Ann Arbor Zoning Board of Appeals has the powers granted by State law and City Code Chapter 55, Section 5:98. A variance may be granted by the Zoning Board of Appeals only in cases involving practical difficulties or unnecessary hardships when **ALL** of the following is found **TRUE**. Please provide a complete response to each item below. These responses, together with the required materials in Section 5 of this application, will form the basis for evaluation of the request by staff and the Zoning Board of Appeals.

1. That the alleged hardships or practical difficulties, or both, are exceptional and peculiar to the property of the person requesting the variance, and result from conditions which do not exist generally throughout the city.

SEE ATTACHED

2. That the alleged hardships are practical difficulties, or both, which will result from a failure to grant the variance, include substantially more than mere inconvenience, inability to attain a higher financial return, or both.

SEE ATTACHED

3. That allowing the variance will result in substantial justice being done, considering the public benefits intended to be secured by this chapter, the individual hardships that will be suffered by a failure of the board to grant a variance, and the rights of others whose property would be affected by the allowance of the variance.

SEE ATTACHED

4. That the conditions and circumstances on which the variance request is based shall not be a self-imposed hardship or practical difficulty.

SEE ATTACHED

5. A variance approved shall be the minimum variance that will make possible a reasonable use of the land or structure.

SEE ATTACHED



# ZONING BOARD OF APPEALS

## PLANNING DEPARTMENT

City Hall: 301 E. Huron St. Ann Arbor, MI 48104-6120

Mailing: P.O. Box 8647, Ann Arbor, MI 48107-8647

Phone: 734.794.6265

Fax: 734.994.8460

[planning@a2gov.org](mailto:planning@a2gov.org)

**Section 2 – ALTERATION TO A NON-CONFORMING STRUCTURE**

Current Use of the Property:

The proposed change is allowed in accordance with Structure Non-Conformance, Section 5:87 (1) (a) & (b), which reads as follows:

(1) A non-conforming structure may be maintained or restored, but no alteration shall be made to a non-conforming structure unless one of the following conditions is met:

a. The alteration is approved by the Zoning Board of Appeals upon finding that it complies as nearly as practicable with the requirements of this Chapter and that it will not have a detrimental effect on neighboring property.

b. The alteration conforms to all the requirements of this Chapter and is made to a building which will be a single-family dwelling on completion of the alteration and is located in an R1, R2, R3, or R4 district.

c. The structure is considered non-conforming due to the following reasons.

REQUIREMENT	EXISTING CONDITION	CODE REQUIREMENT
Lot Area	8,102.85 SF      Ac. 300 SF	8500 SF
Lot Width	77.83 FT	60 FT
Floor Area Ratio		
Open Space Ratio		
Setbacks	12'-4" & 11'-4" / 31' / 44'	25' / 12' / 30'
Parking	4 SP	3
Landscaping	EXISTING TREES & SHRUBS	NONE (FOR THIS WORK)
Other	↘ 12'-4" @ block average of 17'-8" ∴ 5'-4" variance ↘ 11'-4" @ block average of 9'-3" ∴ meets averaging criteria	

Describe the proposed alterations and state why you are requesting this approval:

REMOVAL OF FIRE ESCAPES TO RETURN HISTORIC CHARACTER OF HOME & OTHER  
 MINOR IMPROVEMENTS AS EXPRESSED IN THE ATTACHED HDC SUBMISSION APPROVED.

The alteration complies as nearly as is practicable with the requirements of the Chapter and will not have a detrimental effect on neighboring property for the following reasons:

IN GENERAL THE APPEARANCE OF THE EXTERIOR OF THIS BUILDING WILL BE  
 UNCHANGED SAVE THE HISTORICAL IMPROVEMENT / MODIFICATIONS





# ZONING BOARD OF APPEALS PLANNING DEPARTMENT

City Hall: 301 E. Huron St. Ann Arbor, MI 48104-6120  
Mailing: P.O. Box 8647, Ann Arbor, MI 48107-8647

Phone: 734.794.6265  
Fax: 734.994.8460  
[planning@a2gov.org](mailto:planning@a2gov.org)

## Section 2 – ALTERATION TO A NON-CONFORMING STRUCTURE

Wherefore, Petitioner requests that permission be granted from the above named Chapter and Section of the Ann Arbor City Code in order to permit:

N.A.

## REQUIRED MATERIALS

The following materials are required for **ALL** variance requests. Failure to provide these materials will result in an incomplete application and will delay staff review and Zoning Board of Appeals consideration of the request. The materials listed below must accompany the application and constitute an inseparable part of the application.

All materials must be provided on 8 1/2" by 11" sheets:

- One (1) hardcopy and one (1) electronic copy shall be submitted.
- The electronic copy shall include all associated supporting documentation with application submission.

- Survey of the property including all existing and proposed structures, dimensions of property, and area of property.
- Building floor plans showing interior rooms, including dimensions.
- Photographs of the property and any existing buildings involved in the request.
- Any other graphic or written materials that support the request.

## ACKNOWLEDGEMENT

I, the applicant, hereby request a variance from the above named Chapter (s) and Section (s) of the Ann Arbor City Code for the stated reasons, in accordance with the materials attached hereto.

Phone number:

Signature: X

Email address: carl@kueterarchitects.com

Print Name: CARL G. KUETER

I, applicant, hereby depose and say that all the aforementioned statements, and the statements contained in the materials submitted herewith, as true and correct.

Signature

Further, I hereby give the City of Ann Arbor Planning and Development Services unit staff and members of the Zoning Board of Appeals permission to access the subject property for the purpose of reviewing my variance request.

Signature

28 FEBRUARY 2018

403 WEST LIBERTY

ANN ARBOR, MICHIGAN

CITY OF ANN ARBOR ZONING BOARD OF APPEALS SUBMISSION

FOR

VARIANCE RELIEF TO REQUIRED LOT AREA & FRONT YARD SETBACK

This property located in Ann Arbor's Old West Side Historic District contains a large 1880's brick single family residence and a detached small (12 X 18) brick one car garage. (See details in HDC submission) The original house contained a single family residence on the first, second and third floors and a servant's quarter in the lower level walk out basement. A previous owner was able to convert this residence into a 10 bed/room rooming house, as part of that work an extensive wood fire escape system was imposed on the facade of this handsome building. Since this property was developed prior to the city of Ann Arbor having zoning regulations (1880 versus 1958), when those regulations came into effect the R4C zoning placed on this property rendered its lot size non-conforming (required minimum in R4C is 8,500 square feet and this lot is 8,202 square feet, approximately 3.5 % smaller). The built structure was rendered non-conforming with the imposed R4C front yard setback requirements as shown on the attached site plan.

The current owner wishes to do extensive exterior rehabilitation to this building to return it to its original historical character, for which she had received approval of the Ann Arbor Historic District Commission. In doing this work she would like to return the house to its original configuration (4 bedroom townhouse on first, second and third floor, 2 BR apartment in lower level), by converting it to a duplex (allowed in R4C) and decreasing the number of bedrooms (and therefore occupants) in the entire house from 10 to 6 (A 6 bedroom single family dwelling unit is allowed in R4C).

We feel these conditions imposed by the after the fact zoning of the parcel rendering the parcel non-conforming, coupled with the fact that the work proposed will be internal and have no major outward impact on the appearance of the building or site.

The house could be converted to a 6 bedroom single family without coming before this board. This type of occupancy would attract a large group rental occupancy, more than likely students in the Old West Side neighborhood. The property owner would prefer to provide two smaller units (same number of bedrooms) such that the main house is looked upon as a townhouse rental and the lower level 2 BR apartment as was the original configuration of the home in the 1880's although a single family with servants quarters at that time. This two unit use would be less intensive then the large group rental format.

1 The non-conforming conditions being requested for relief are unique to this property being that the existing site pre-dates the imposition of the current zoning district requirements for lot size and setbacks by the R4C zoning district standards placed on it by the city. In addition these changes only affect the interior of the structure in room configurations and usage.



2 The request to allow the internal conversion of the existing 10 room rooming house to a 2 BR and 4 BR duplex would provide a better more compatible unit mix to this neighborhood, rather than a large 6 BR single family rental.

3 The public benefit of this proposed work will allow this building to be restored to its original historical character, enhancing and reinforcing the fabric of the Old West Side Historic District, as well as provide housing for two families in this neighborhood and the near downtown business district.

a) Enhance and strengthen the character of the Old West Side Historic District at a key entry point to the district. "This house is one of the entry gate posts on West Liberty to the Old West Side."

b) Eliminate a building use found to be undesirable (rooming house).

c) Provide two dwelling units of housing to the downtown area.

4 The noted requests are for issues regarding this property which are existing and predate those imposed by the zoning district applied by the city and not the property owner.

5 Since the outward appearance of this structure and the property will remain unchanged save for the noted improvements granted by the HDC, we feel this is the minimum variance request to satisfy these improvements.

The variances being sought are:

- 1) To allow R4C zoned property to receive a variance of 298 square feet on the R4C district minimum lot size requirement of 8,500 square feet for its existing 8,202 square feet size so this 10 room rooming house, regarded as a single family dwelling unit, may change from a single family residence to a duplex to allow the interior to be reconfigured into a 2 bedroom lower level apartment and a 4 bedroom first/second/third floor townhouse.
- 2) To allow the West Liberty block averaged front yard setback of 17' 8 "to vary 5' 8" to be 12' 0" at this property. (Note: Second Street front yard setback is with in block averaged front yard setbacks)

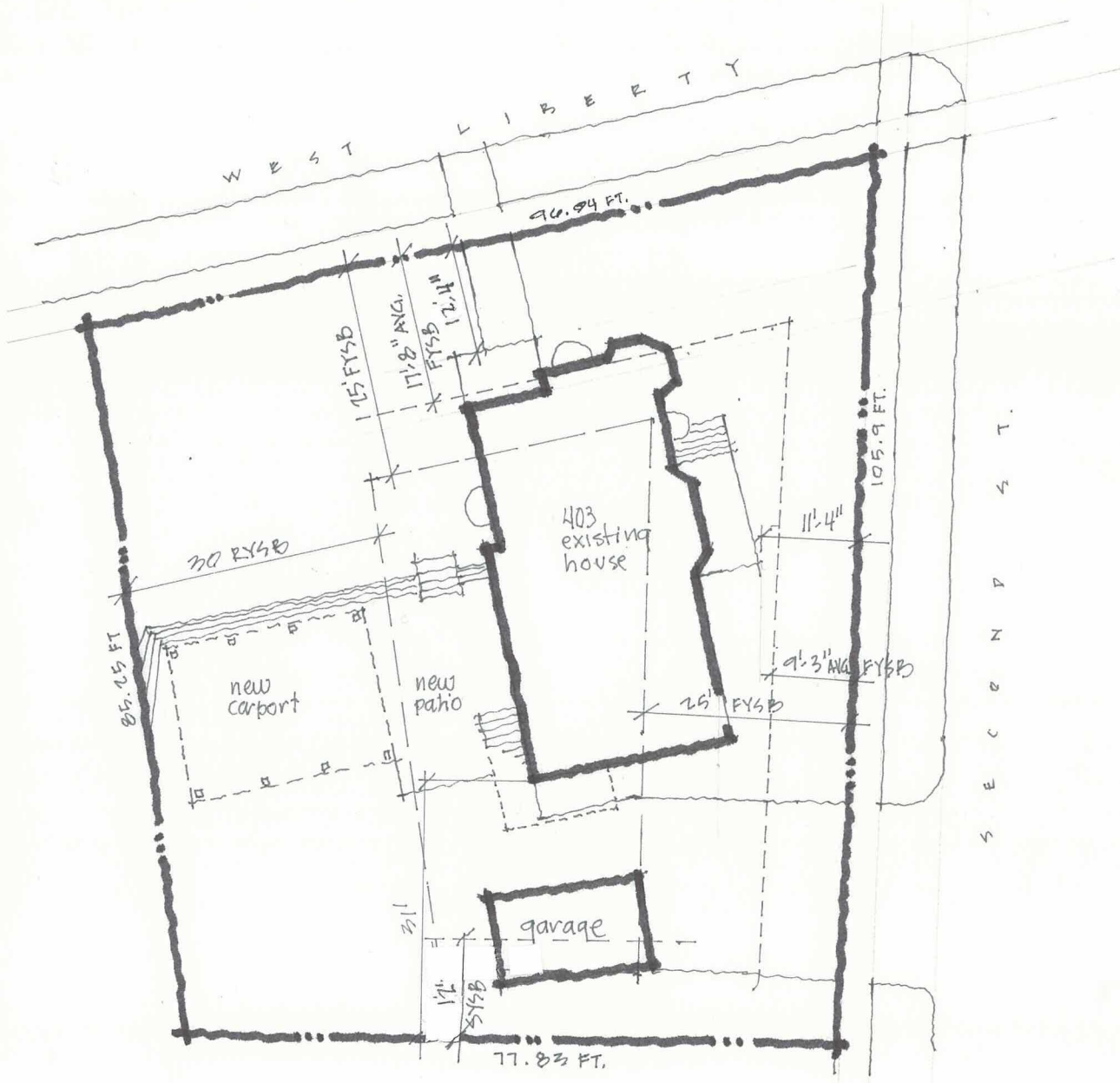

403 SITE PLAN @ 1" = 10' 0" 



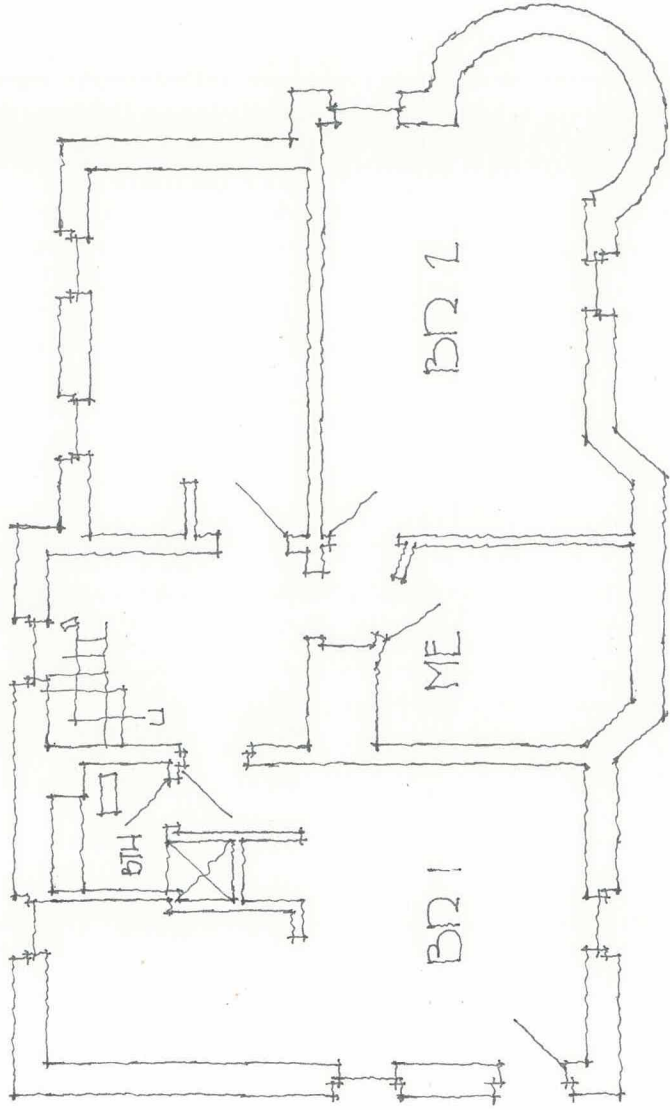

413 ■ EXISTING LOWER LEVEL

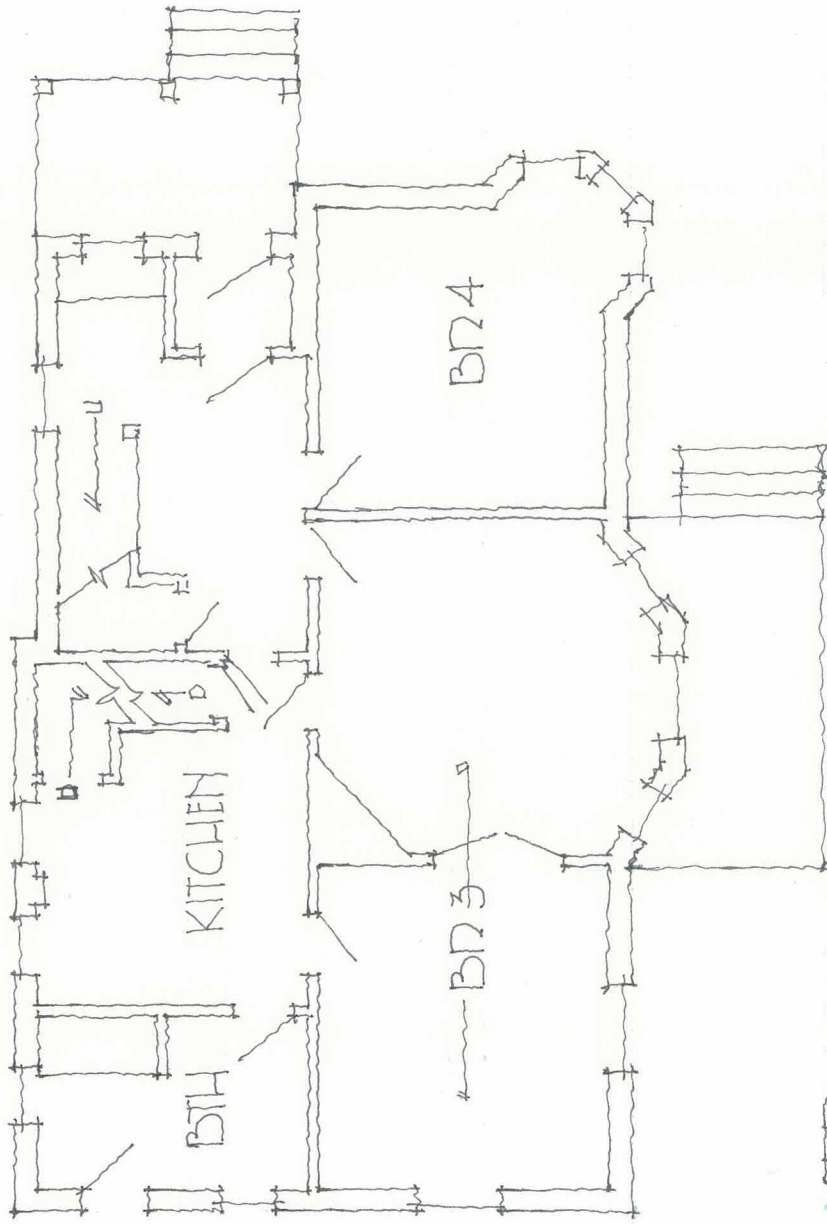

41B - EXISTING 1<sup>st</sup> FLOOR



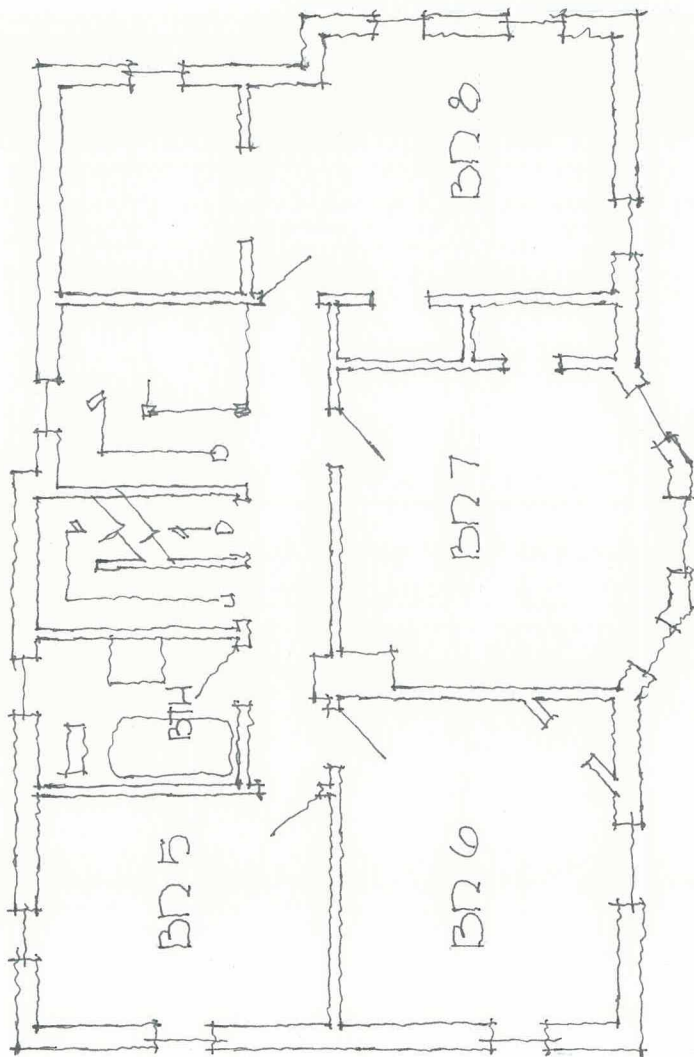

MEB - EXISTING 2<sup>nd</sup> FLOOR

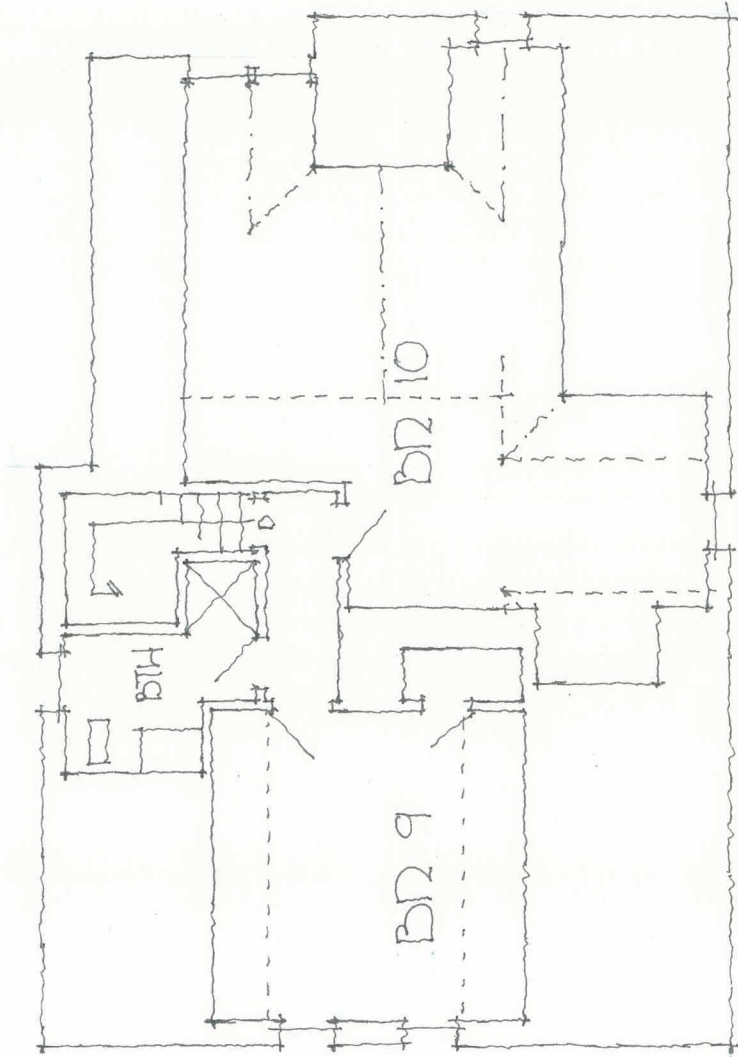

41E - EXISTING 3<sup>rd</sup> FLOOR

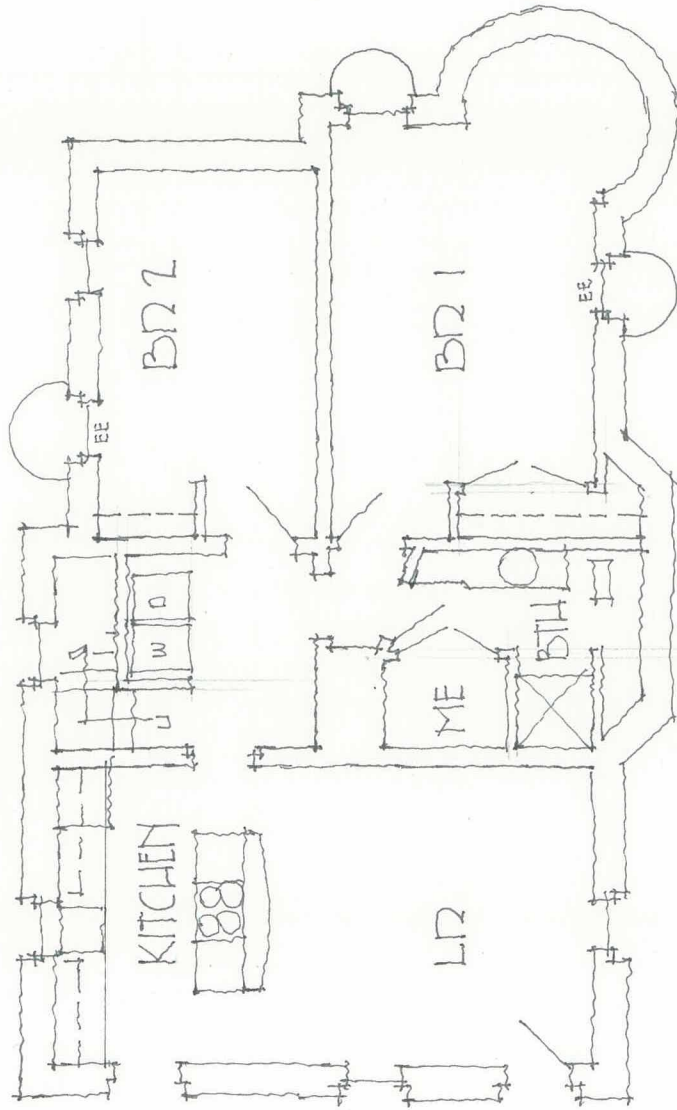

413 - LOWER LEVEL 2BR APARTMENT



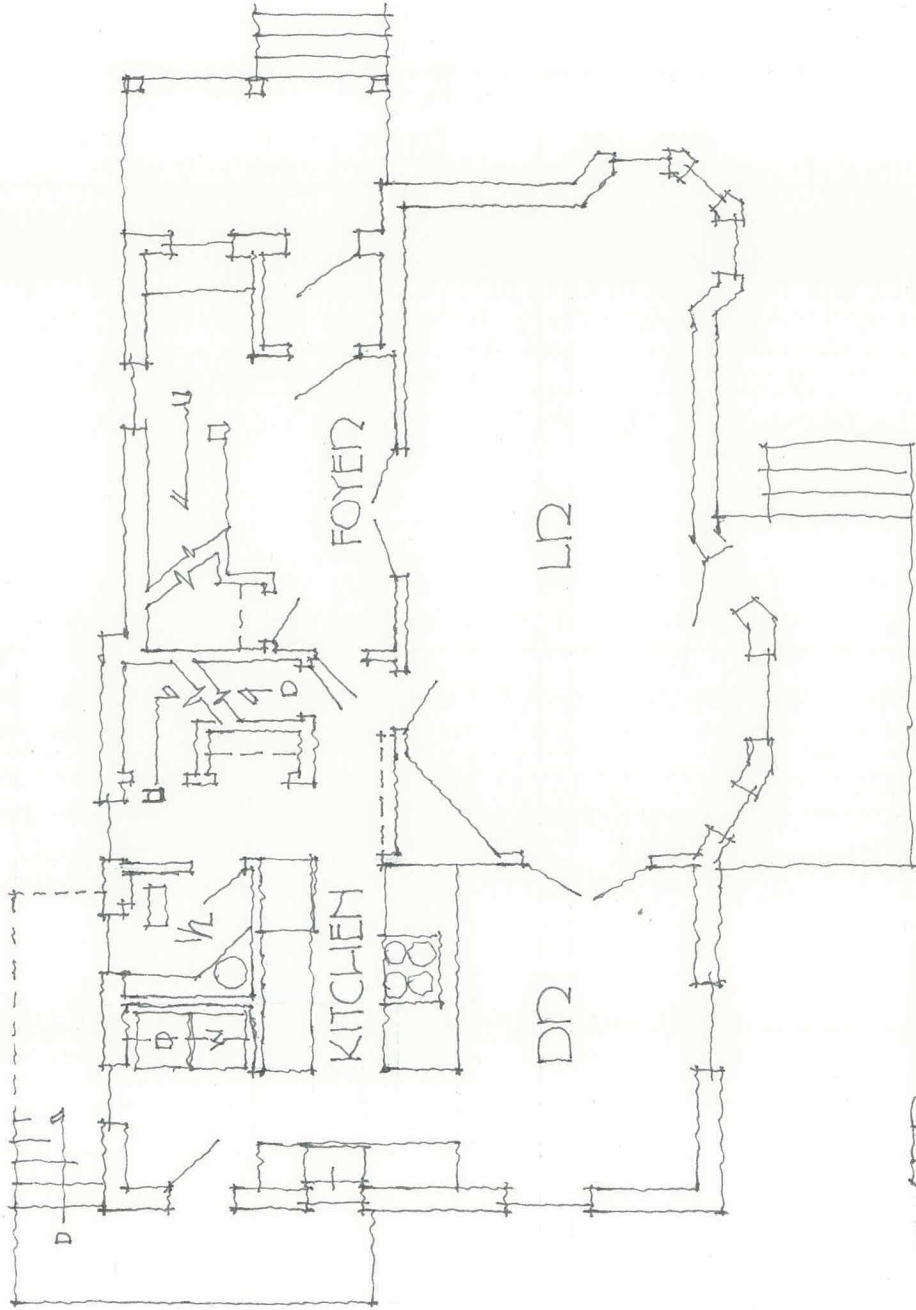

MEB 1st FLOOR ° TOWNHOUSE

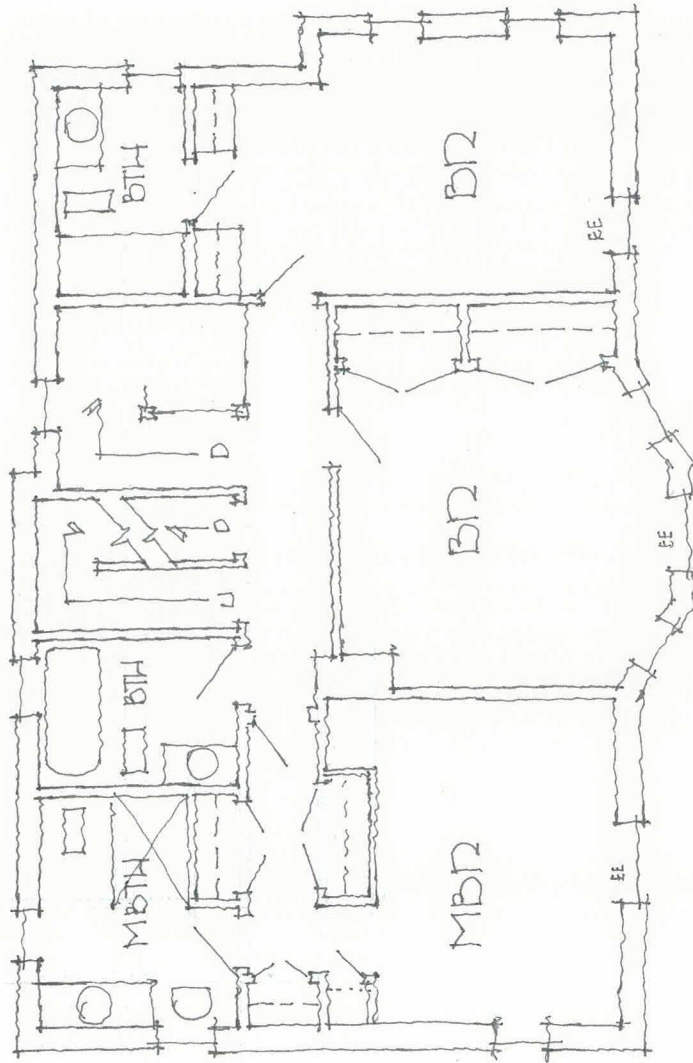

413 - 2nd FLOOR - TOWNHOUSE

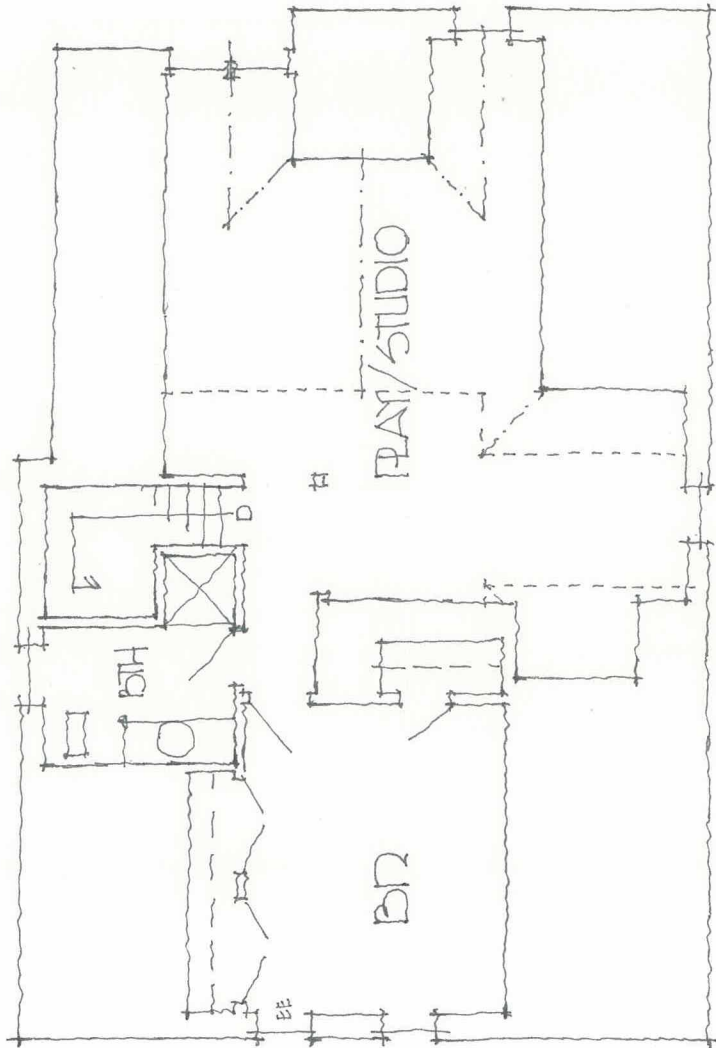

MEB<sup>a</sup> 3<sup>rd</sup> FLOOR • TOWNHOUSE



## ANN ARBOR HISTORIC DISTRICT COMMISSION

### Staff Report

**ADDRESS:** 403 W Liberty Street, Application Number HDC18-014

**DISTRICT:** Old West Side Historic District

**REPORT DATE:** February 8, 2018

**REPORT PREPARED BY:** Jill Thacher, Historic Preservation Coordinator

**REVIEW COMMITTEE DATE:** Monday, February 5, 2018

	<b>OWNER</b>	<b>APPLICANT</b>
<b>Name:</b>	403 West Liberty, LLC	Carl O. Hueter A.I.A.
<b>Address:</b>	403 West Liberty Ann Arbor, MI 48104	1321 Franklin Blvd Ann Arbor, MI 48103
<b>Phone:</b>	(734) 327-6605	(734) 276-8175

**BACKGROUND:** A 1 ½ story house is shown on 1888 and 1892 Sanborn Fire Insurance Maps at this corner. The 2 ½ story brick Queen Ann we see today was probably built in 1894. In that year it was the home of F.G. Schleicher. The house features a prominent stone foundation, porches on both street sides with fancy millwork, a round single-story bay window with a round bracketed eave and stone foundation, corner returns in some gables, some bracketed eaves, a clipped gable on the rear elevation, and round-topped attic windows. The single-car brick garage was added between 1916 and 1925, per Sanborn maps.

**LOCATION:** The property is located on the south side of West Liberty, at the southwest corner of Second Street.

**APPLICATION:** The applicant seeks HDC approval for many work items, please see Proposed Work list attached to application for details. The work includes removing all fire escapes, unblocking infilled windows, installing several egress windows in wells, replacing concrete porch steps with wood, replicating original porch skirting, constructing a new rear porch and stair to an existing door, lowering the non-original hump on the roof and adding a skylight to it, constructing a three-car carport, adding paveres and a patio, and adding a 30" high wrought iron fence along the two street fronts.

#### **APPLICABLE REGULATIONS:**

##### **From the Secretary of the Interior's Standards for Rehabilitation:**

- (1) A property shall be used for its historic purpose or be placed in a new use that requires minimal change to the defining characteristics of the building and its site and environment.

- (2) The historic character of a property will be retained and preserved. The removal of distinctive materials or alteration of features, spaces, and spatial relationships that characterize a property will be avoided.
- (5) Distinctive features, finishes, and construction techniques or examples of craftsmanship that characterize a historic property shall be preserved.
- (6) Deteriorated historic features shall be repaired rather than replaced. Where the severity of deterioration requires replacement of a distinctive feature, the new feature shall match the old in design, color, texture, and other visual qualities and, where possible, materials. Replacement of missing features shall be substantiated by documentary, physical, or pictorial evidence.
- (9) New additions, exterior alterations, or related new construction shall not destroy historic materials that characterize the property. The new work shall be differentiated from the old and shall be compatible with the massing, size, scale, and architectural features to protect the historic integrity of the property and its environment.
- (10) New additions and adjacent or related new construction shall be undertaken in such a manner that if removed in the future, the essential form and integrity of the historic property and its environment would be unimpaired.

**From the Secretary of the Interior's Guidelines for Rehabilitating Historic Buildings (other SOI Guidelines may also apply):**

**District or Neighborhood Setting**

*Not Recommended:* Introducing new construction into historic districts that is visually incompatible or that destroys historic relationships within the setting.

**Building Site**

*Recommended:* Designing new exterior additions to historic buildings or adjacent new construction which is compatible with the historic character of the site and which preserve the historic relationship between a building or buildings, landscape features, and open space.

Identifying, retaining, and preserving buildings and their features as well as features of the site that are important in defining its overall historic character. Site features can include driveways, walkways, lighting, fencing, signs, benches, fountains, wells, terraces, canal systems, plants and trees, berms, and drainage or irrigation ditches; and archeological features that are important in defining the history of the site.

Retaining the historic relationship between buildings, landscape features, and open space.

*Not Recommended:* Introducing new construction onto the building site which is visually incompatible in terms of size, scale, design, materials, color and texture or which destroys historic relationships on the site.



Removing or radically changing buildings and their features or site features which are important in defining the overall historic character of the building site so that, as a result, the character is diminished.

### **Health and Safety**

Recommended: Identifying the historic building's character-defining spaces, features, and finishes so that code-required work will not result in their damage or loss.

Complying with health and safety codes, including seismic code requirements, in such a manner that character-defining spaces, features, and finishes are preserved.

Not Recommended: Altering, damaging, or destroying character-defining spaces, features, and finishes while making modifications to a building or site to comply with safety codes.

### **Windows**

Not Recommended: Introducing a new design that is incompatible with the historic character of the building.

## **STAFF FINDINGS:**

1. The house is currently a 10 bedroom rental rooming house. The owner proposes to convert it to a duplex, with a two bedroom apartment in the walk-out basement and a four-bedroom apartment on the upper three floors. A variance will be required from the Zoning Board of Appeals if this application is approved by the Historic District Commission.
2. A number of restoration activities are included, all of which staff feels are appropriate and well thought-out. Removing the wood fire escapes that are cluttering the building is particularly welcome.
3. Three basement windows in new wells are proposed, to meet egress requirements from the basement apartment. The new windows would be clad wood, which is appropriate. Details on the sizes of the windows and window wells has been requested from the architect.
4. The new rear entry porch to the original kitchen, with metal stairs and a cable guardrail, is a modern and compatible design that has a minimalistic feel. It does not compete with or distract from the historic character of the house.
5. The hump on the roof (staff assumes it is for stairwell head height) cannot be completely removed per building code, but is proposed to be lowered and made less obvious. A large skylight proposed to be added to this non-original feature will be minimally visible.
6. The carport is proposed in the same area currently used for parking, and would be serviced by the existing driveway off Second Street. It is more than 40 feet from West Liberty Street. A new 4' fieldstone retaining wall between the house and west property line would result in the carport setting lower than the grade of the yard at the street, which

would help minimize its modest 14' height. The hipped roof design also helps the carport appear smaller. The contributing historic brick one-car garage would remain. The courtyard area behind the carport would be converted from gravel to precast grass pavers. A 16'x24' bluestone patio is proposed between the carport and rear of the house.

7. The design of the fence is appropriate for a masonry house of this age, as is the height. The fence needs to be newly manufactured, not a reclaimed or historic fence from another property. Staff will confirm that information at the fence permit stage.
8. Staff's opinion is that the work does not destroy historic materials features, spaces, or spatial relationships that characterize the property; that the new carport is adequately differentiated and compatible in size, scale, and design; and that overall, the proposed work enhances the character and historic integrity of the house.

## MOTION

(Note that the motion is only a suggestion. The Review Committee, consisting of staff and at least two Commissioners, will meet with the applicant on site and then make a recommendation at the meeting.)

I move that the Commission issue a certificate of appropriateness for the application at 403 West Liberty, a contributing property in the Old West Side Historic District, to remove all fire escapes, unblock infilled windows, install several egress windows in wells, replace concrete porch steps with wood, replicate original porch skirting, construct a new rear porch and stair to an existing door, lower the non-original hump on the roof and add a skylight to it, construct a three-car carport, add pavers and a patio, and add a 30" high wrought iron fence along the two street fronts, as proposed. The work is compatible in exterior design, arrangement, materials, and relationship to the house and the surrounding area and meets the *City of Ann Arbor Historic District Design Guidelines* and *The Secretary of the Interior's Standards for Rehabilitation and Guidelines for Rehabilitating Historic Buildings*, in particular standards 2, 9 and 10 and the guidelines for District or Neighborhood Setting, Building Site, Health and Safety, and Windows.

## MOTION WORKSHEET

I move that the Commission issue a Certificate of Appropriateness for the work at 403 W Liberty in the Old West Side Historic District

\_\_\_\_\_ Provided the following condition(S) is (ARE) met: 1) STATE CONDITION(s)

The work is generally compatible with the size, scale, massing, and materials and meets the Secretary of the Interior's Standards for Rehabilitation, standard(S) number(S) (*circle all that apply*): 1, 2, 3, 4, 5, 6, 7, 8, 9, 10

**ATTACHMENTS:** application, photos, drawings, materials details



403 W Liberty (August 2017, courtesy Google)



403 W Liberty (Aerial Photo 2015)







# HISTORIC DISTRICT COMMISSION

## PLANNING AND DEVELOPMENT SERVICES

City Hall: 301 E. Huron St. Ann Arbor, MI 48104-6120  
 Mailing: P.O. Box 8647, Ann Arbor, MI 48107-8647  
 Phone: 734.794.6265 ext. 42608 [jthacher@a2gov.org](mailto:jthacher@a2gov.org)  
 Fax: 734.994.8460

OFFICE USE ONLY	
Permit Number	HDC# _____
	BLDG# _____
DATE STAMP	

**APPLICATION MUST BE FILLED OUT COMPLETELY**

### PROPERTY LOCATION/OWNER INFORMATION

NAME OF PROPERTY OWNER <b>403 WEST LIBERTY, LLC</b>		HISTORIC DISTRICT <b>OLD WEST SIDE</b>	
PROPERTY ADDRESS <b>403 WEST LIBERTY</b>			CITY <b>ANN ARBOR</b>
ZIP CODE <b>48104</b>	DAYTIME PHONE NUMBER <b>(734) 327-6605</b>	EMAIL ADDRESS <b>janet.muhleman@reagroup.us</b>	
PROPERTY OWNER'S ADDRESS (IF DIFFERENT FROM ABOVE) <b>213 WEST LIBERTY</b>		CITY <b>ANN ARBOR</b>	STATE, ZIP <b>MI. 48104</b>

### PROPERTY OWNER'S SIGNATURE

<b>SIGN HERE</b>	<i>on original</i>	<b>PRINT NAME</b> <b>JANET MUHLEMAN</b>	<b>DATE</b> <b>1/19/18</b>
------------------	--------------------	---	----------------------------

### APPLICANT INFORMATION

NAME OF APPLICANT (IF DIFFERENT FROM ABOVE) <b>CARL O. HUETER A.I.A.</b>			
ADDRESS OF APPLICANT <b>1321 FRANKLIN BLYD.</b>			CITY <b>ANN ARBOR</b>
STATE <b>MI.</b>	ZIP CODE <b>48103-5802</b>	PHONE / CELL # <b>(734) 276.8175</b>	FAX No <b>(NONE)</b>
EMAIL ADDRESS <b>carl@hueterarchitects.com</b>			

### APPLICANT'S SIGNATURE (if different from Property Owner)

<b>SIGN HERE</b>	<b>PRINT NAME</b> <b>X CARL O. HUETER</b>	<b>DATE</b> <b>1/16/18</b>
------------------	---	----------------------------

### BUILDING USE - CHECK ALL THAT APPLY

<input type="checkbox"/> SINGLE FAMILY	<input checked="" type="checkbox"/> DUPLEX	<input checked="" type="checkbox"/> RENTAL	<input type="checkbox"/> MULTIPLE FAMILY	<input type="checkbox"/> COMMERCIAL	<input type="checkbox"/> INSTITUTIONAL
--	--	--	--	-------------------------------------	--

### PROPOSED WORK

Describe in detail each proposed exterior alteration, improvement and/or repair (use additional paper, if necessary).

**SEE ATTACHED**

### DESCRIBE CONDITIONS THAT JUSTIFY THE PROPOSED CHANGES:

**SEE ATTACHED**

For Further Assistance With Required Attachments, please visit [www.a2gov.org/hdc](http://www.a2gov.org/hdc)



# HISTORIC DISTRICT COMMISSION APPLICATION

## FEE CHART

DESCRIPTION	
<b>STAFF REVIEW FEES</b>	
Application for Staff Approval	\$35.00
Work started without approvals	Additional \$50.00
<b>HISTORIC DISTRICT COMMISSION FEES</b>	
All other proposed work not listed below	\$100.00
Work started without approvals	Additional \$250.00
<b>RESIDENTIAL – Single and 2-story Structure</b>	
Addition: single story	\$300.00
Addition: taller than single story	\$550.00
New Structure - Accessory	\$100.00
New Structure – Principal	\$850.00
Replacement of single and 2-family window(s)	\$100 + \$25/window
<b>COMMERCIAL – includes multi-family (3 or more unit) structures</b>	
Additions	\$700.00
Replacement of multi-family and commercial window (s)	\$100 + \$50/window
Replacement of commercial storefront	\$250.00
<b>DEMOLITION and RELOCATION</b>	
Demolition of a contributing structure	\$1000.0
Demolition of a non-contributing structure	\$250.00
Relocation of a contributing structure	\$750.00
Relocation of a non-contributing structure	\$250.00

### FOR COMMISSION REVIEWS:

- Application withdrawals made before public notice is published will qualify for a 50% refund of the application fee.
- Application withdrawals made after public notice is sent but before the public hearing will qualify for a 25% refund of the application fee.

## INSTRUCTIONS FOR SUBMITTING APPLICATIONS

All HDC applications must be signed by the property owner and the applicant, if different, with the exception of staff approvals, which may be signed by only the applicant.

All completed HDC applications and their attachments may be submitted to Planning and Development Services by mail, in person (paper or digital), faxed, or via email to [building@a2gov.org](mailto:building@a2gov.org).

We accept CASH, CHECK, and all major credit cards. Checks should be made payable to "City of Ann Arbor"

HDC applications that are incomplete or not submitted with the required documentation or payment will not be processed or approved.

## APPLICATION EXPIRATION

HDC applications expire three (3) years after the date of approval.

## OFFICE USE ONLY

Date of Hearing:		
Action	<input type="checkbox"/> HDC COA	<input type="checkbox"/> HDC Denial
	<input type="checkbox"/> HDC NTP	<input type="checkbox"/> Staff COA
Staff Signature		
Comments		
Fee:	\$ _____	
Payment Type	<input type="checkbox"/> Check: # _____ <input type="checkbox"/> Cash <input type="checkbox"/> Credit Card	



403 WEST LIBERTY \* OLD WEST SIDE HISTORIC DISTRICT

HISTORIC DISTRICT COMMISSION SUBMISSION

19 JANUARY 2018

**PROPOSED WORK**

The owner of the above property wishes to change the use of this former grand single family residential property from its current 10 bedroom rental rooming house to a 2 unit (duplex). The units would be a lower level (walk-out basement) 2 bedroom unit apartment and the first/second/third floors as a four bedroom townhouse unit. In doing so the following items of exterior work are being proposed for the review and approval of the historic district commission.

- 1) Remove all of the applied wood fire escape stairs and landings located around the four sides of the building. Repair any damage to original structure/masonry.
- 2) Re-open south window opening, now infilled with stone, into new lower level apartment. Use historically correct compliant clad double hung wood window.
- 3) Re-open existing west lower level window with new area well to provide egress window to existing bedroom at lower level apartment. Use historically correct compliant window sized to allow meeting code egress requirements.
- 4) Re-open existing north lower level window opening with new area well. Use historically correct compliant clad basement hopper type clad wood window unit.
- 5) Restore second floor plywood egress door with original window configuration. New window to match adjacent exactly in design and construction.
- 6) Replace north front pre-cast concrete steps with wood. Provide code compliant metal handrail.
- 7) Revise east window opening adjacent to east porch stairs to meet egress requirements to existing bedroom with area well. Use historically correct compliant clad double hung/hinged egress casement clad wood window.
- 8) Replace east porch stair and handrail to match new north porch. Re-use existing original wood rail, with addition of code compliant metal railing.
- 9) Restore the under porch skirt screening on the east porch. To be identical to the patterned wood north entry porch skirt screen.
- 10) Rebuild the rear first floor (south) entry porch and stair to original first floor kitchen delivery door. Purposefully designed to not be a historical recreation (no photographic evidence to date exists of what was originally there). Light visually minimal steel and wire cable design to meet current code. Stair will be open grate steel stair with same rail and cable configuration.
- 11) Diminish the size (height) and add open skylight roof to the west roof "hump". In doing so also blend the finishes into the existing roof/house such that it is visually less obtrusive on the elevations. (Patinated copper to deep brown and arrest oxidation) (See elevation/perspective sketch)
- 12) Construct a three car open carport in the rear yard auto court. (See site plan and elevations) Sidewalls to be open wood screening. Building set down low, so not visible from Liberty and hidden from Second St. by existing house and garage.
- 13) Add a wrought iron fence along Second St. and West Liberty. 30 inch height.

In addition the intent is to:



- A) Restore all of the existing original windows by a professional experienced in said restorations.
- B) Repaint the exterior wood work.
- C) Restore the relatively intact original interior.
- D) Enhance and improve the exterior landscaping and landscape features. Pave auto court in precast grass pavers to make a pervious green paved surface.

This property owner is known to the HDC for the already completed work at 310 Second Street next door to this property.

**DESCRIBE CONDITIONS THAT JUSTIFY THE PROPOSED WORK**

This owner's proven desire to return her properties to as original condition as possible as demonstrated at 310 Second St., while maintaining as near as possible, economic viability in their use. In doing so enhance and strengthen the character and architectural fabric of the Old West Side Historic District.

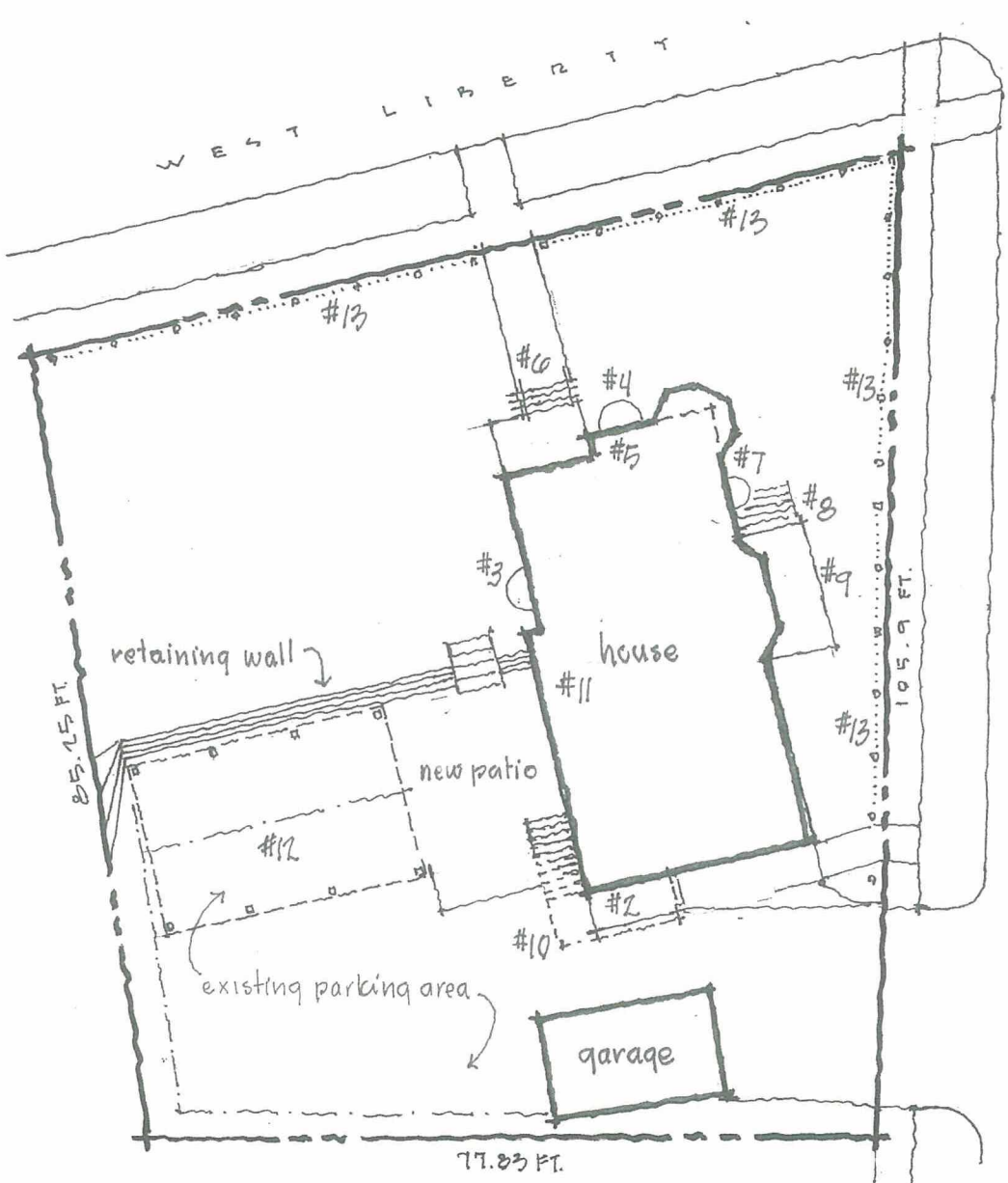

403 - SITE PLAN



**NE corner elevation from corner of Second Street (left) and West Liberty (right):**

- #1 All fire escapes to be removed
- #4 Re-establish basement window at front next to bay
- #5 Re-establish 2<sup>nd</sup> floor window to match existing adjacent original units
- #6 Redo entry porch handrail to match east porch
- #7 Revise basement window adjacent to east porch steps to be egress window
- #8 Replace east porch and entry porch steps
- #13 Erect wrought iron fence along sidewalks both directions



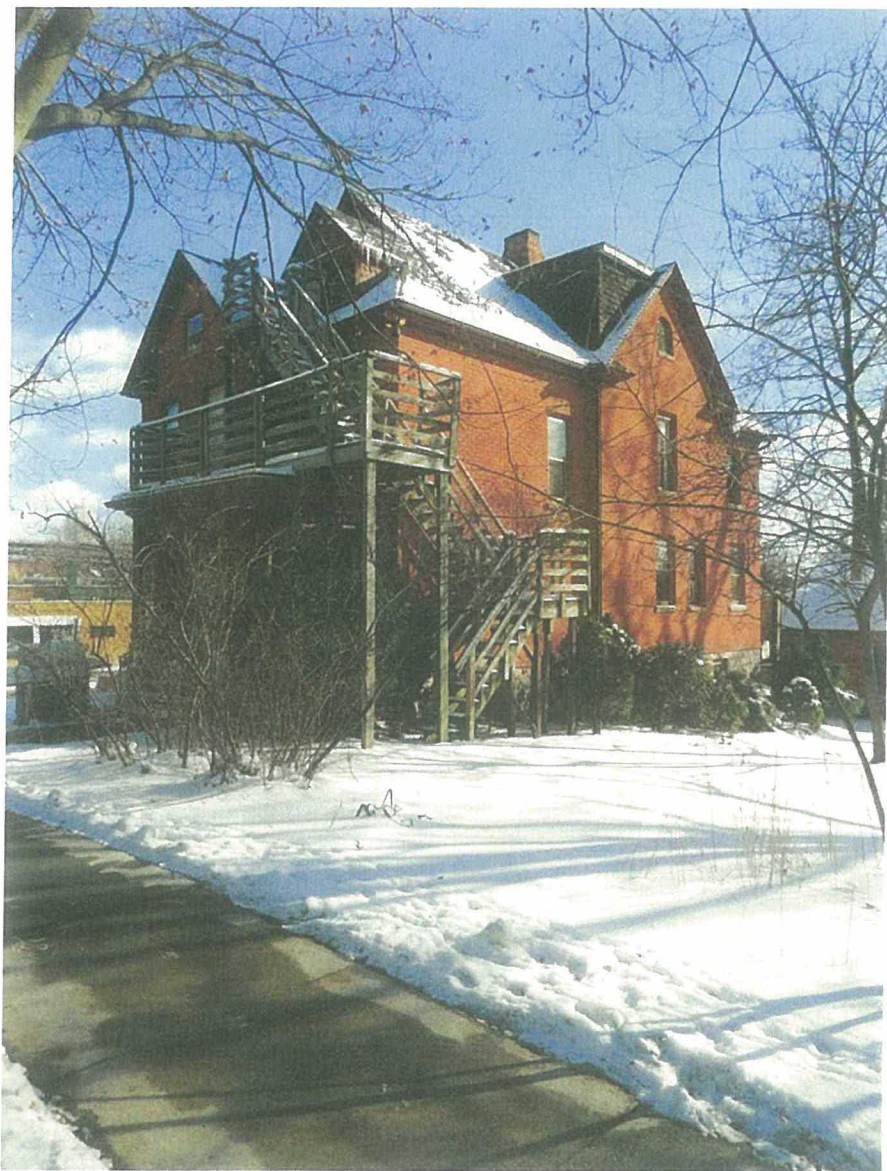

**NW corner elevation from West Liberty:**

See NE corner elevation notes above plus;

- #3 Re-establish basement window open as egress window with area well (behind ) yew bushes on west elevation
- #11 Re-work hump on roof to diminish its size, ad skylights into top and finish it to blend in more to roof

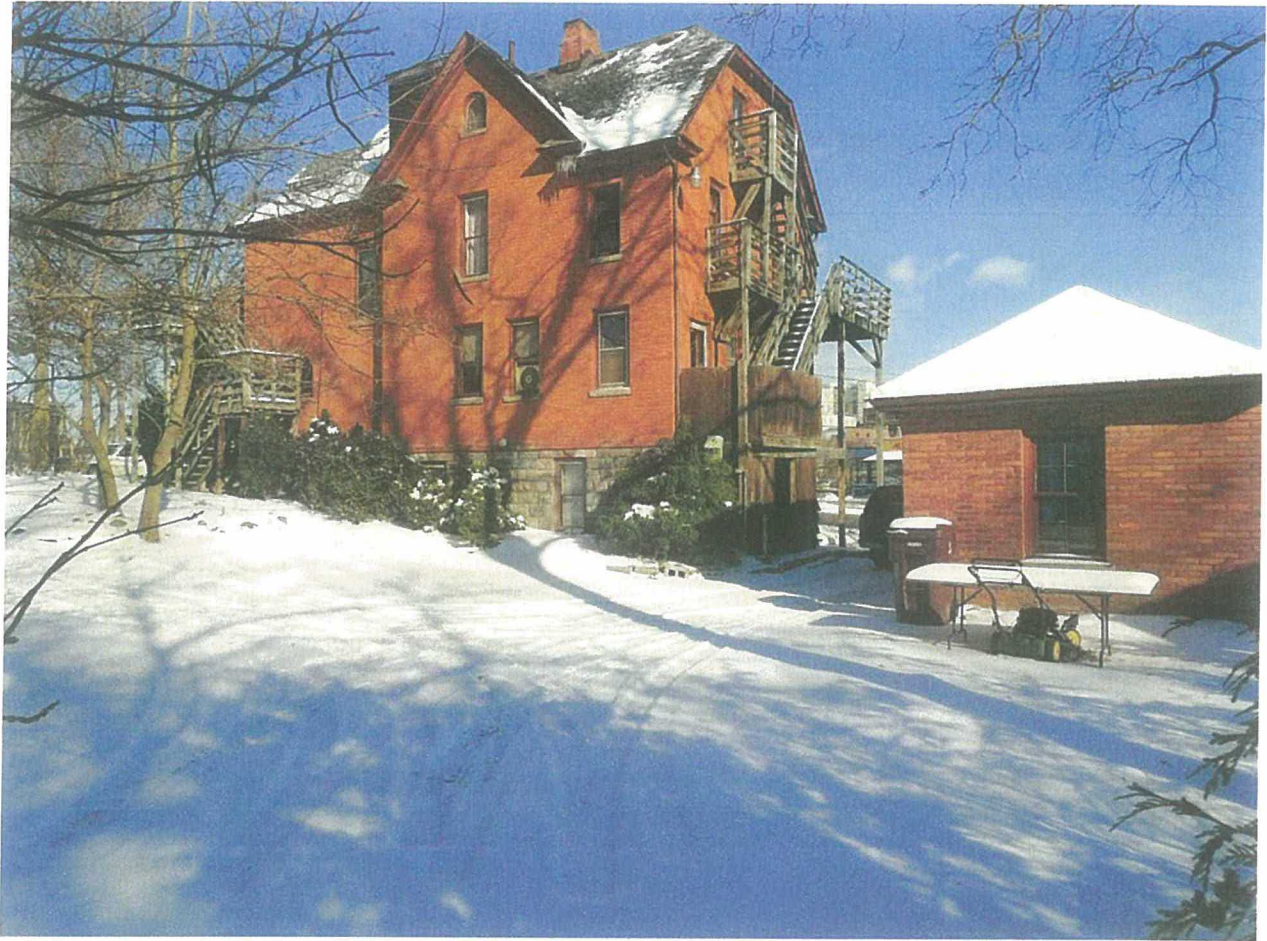

West elevation: (also showing south):

- #1 Remove all of the applied wood fire escape stairs and landings located around the four sides of the building.
- #3 Re-open existing west lower level window and enlarge with area well to provide egress window to existing bedroom at lower level apartment
- #10 Rebuild the rear first floor (south) entry porch and stair to original first floor kitchen delivery door
- #11 Diminish the size and add skylights to the west roof "hump". In doing so also blend the finishes into the existing roof such that it is visually less obtrusive on the elevations. (See elevation sketch)
- #12 Construct a three car open carport in the rear yard auto court. (See site plan and elevations)



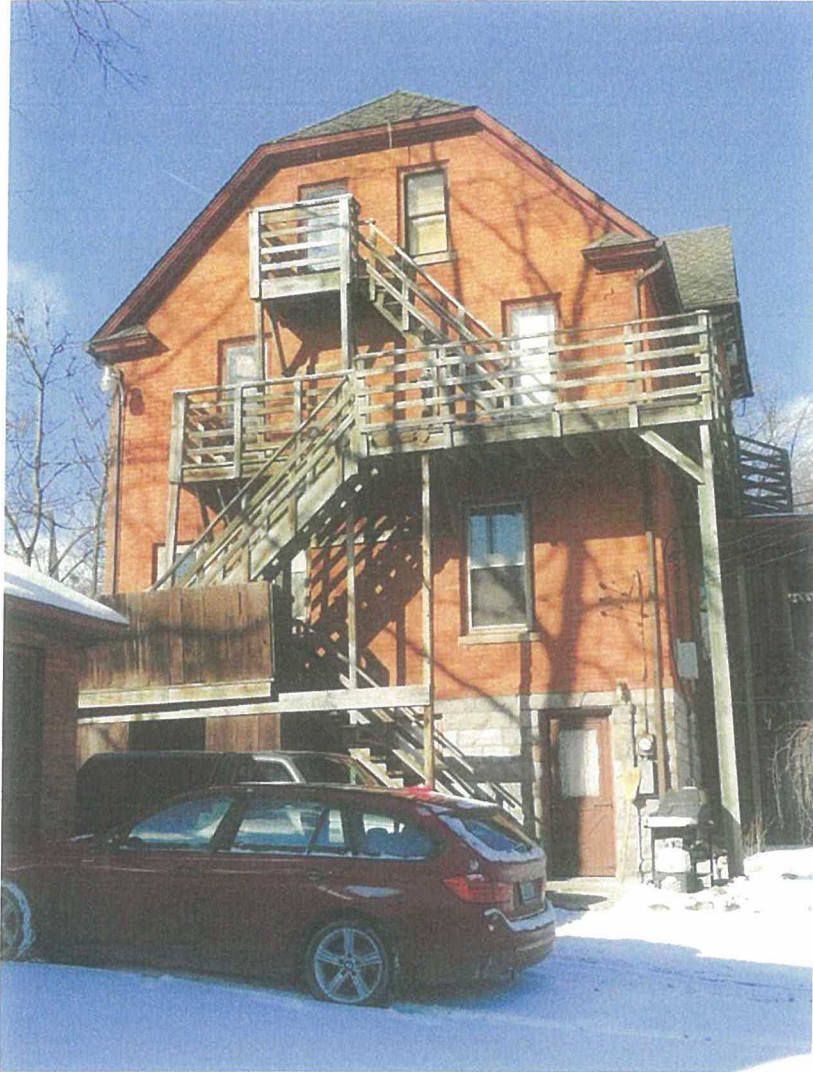

**South elevation:**

- #1 Remove fire escapes
- #2 Re-open south window opening, now infilled with stone, into new lower level apartment
- #10 Build new south porch off of second floor to replace original with steps leading off and around to west





- #3 West basement window noted above to be re-opened and re-worked in size to make an egress window to an existing bedroom, including and in ground area well



- #2 Re-open south basement window presently infilled with stone

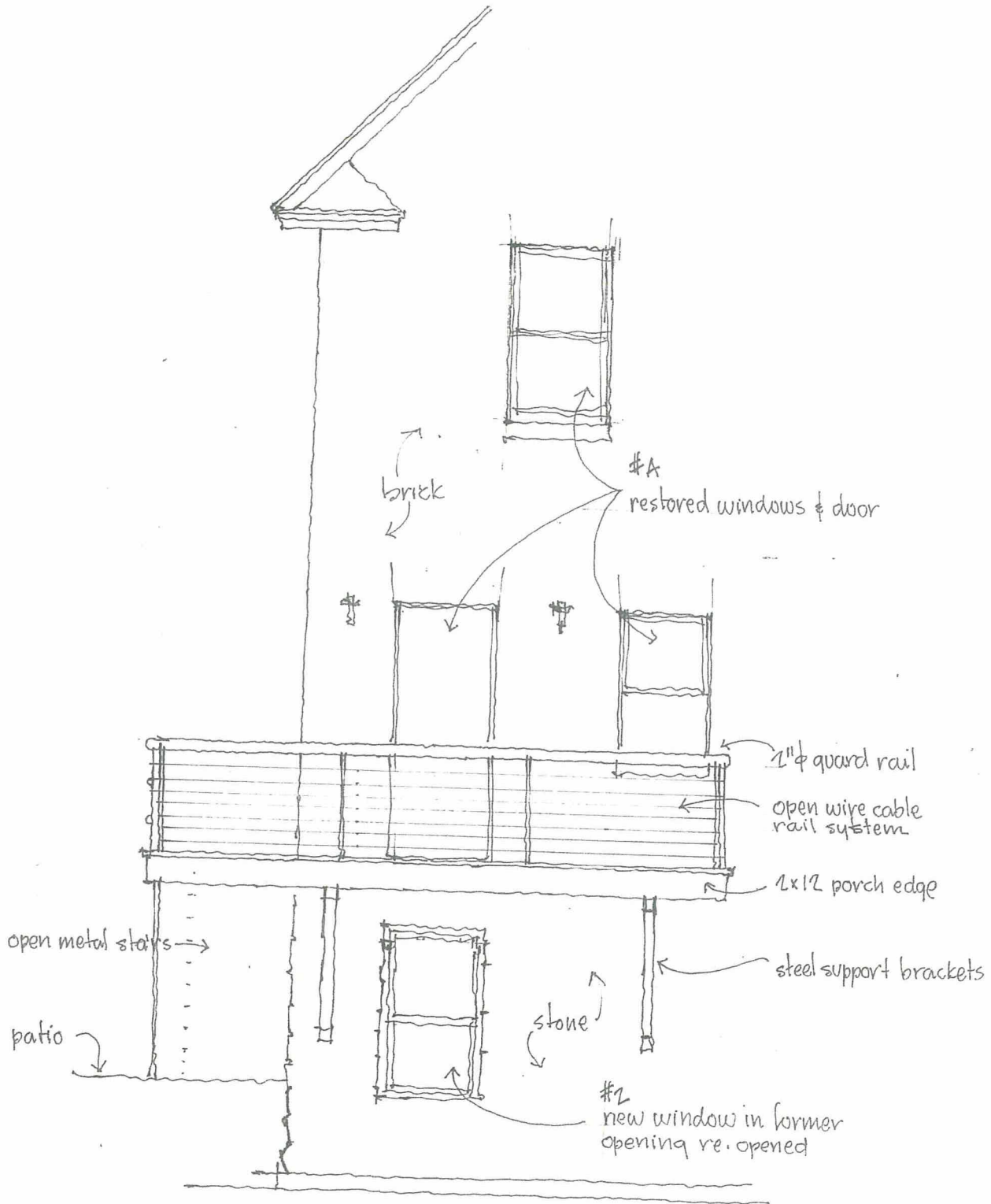

413 NEW SOUTH FIRST FLOOR ENTRY PORCH #10

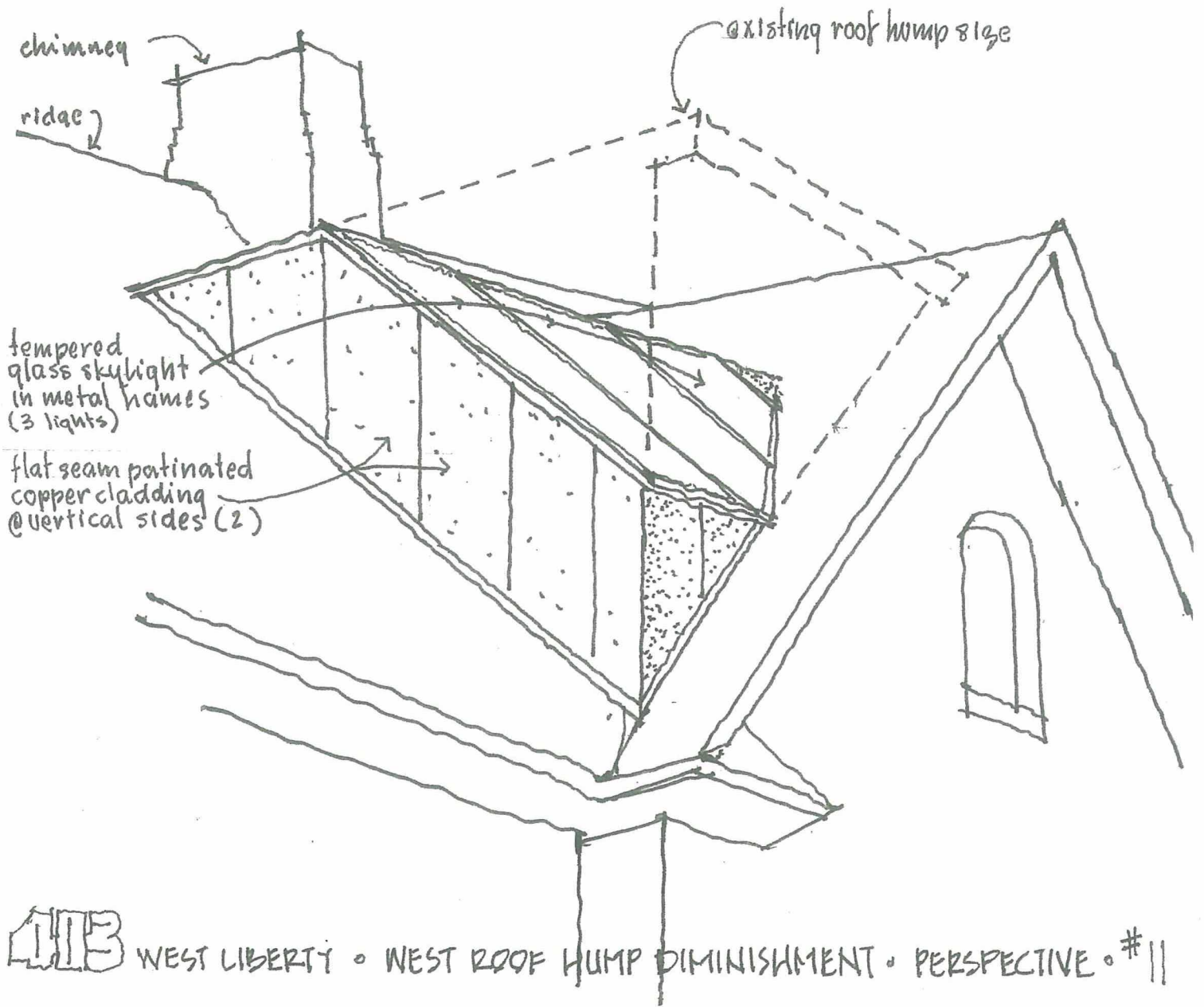



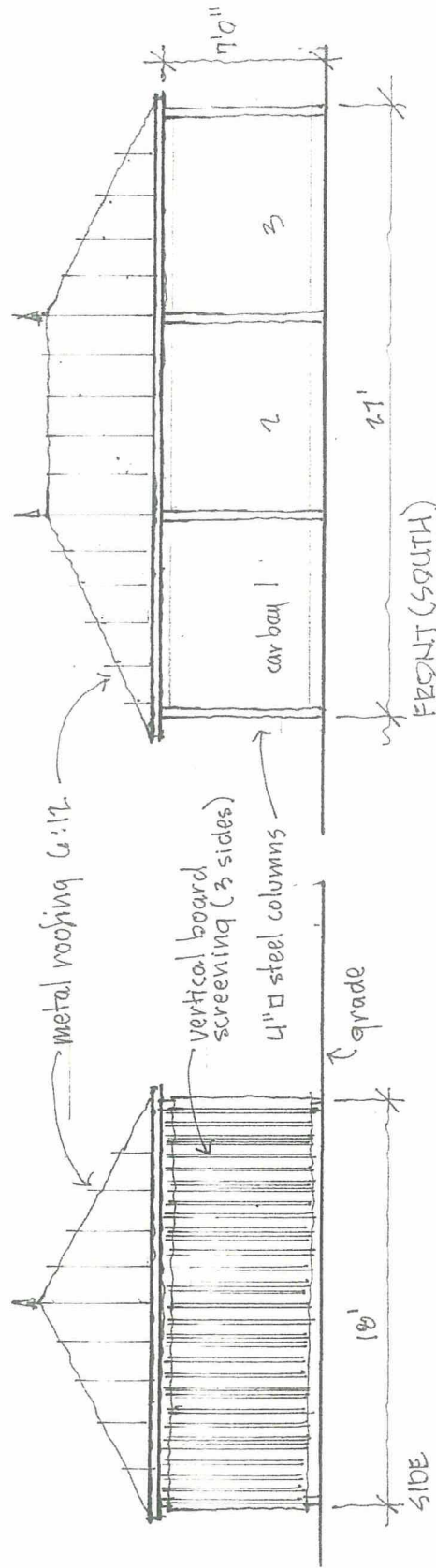

# THIS CARPORT ELEVATIONS #12

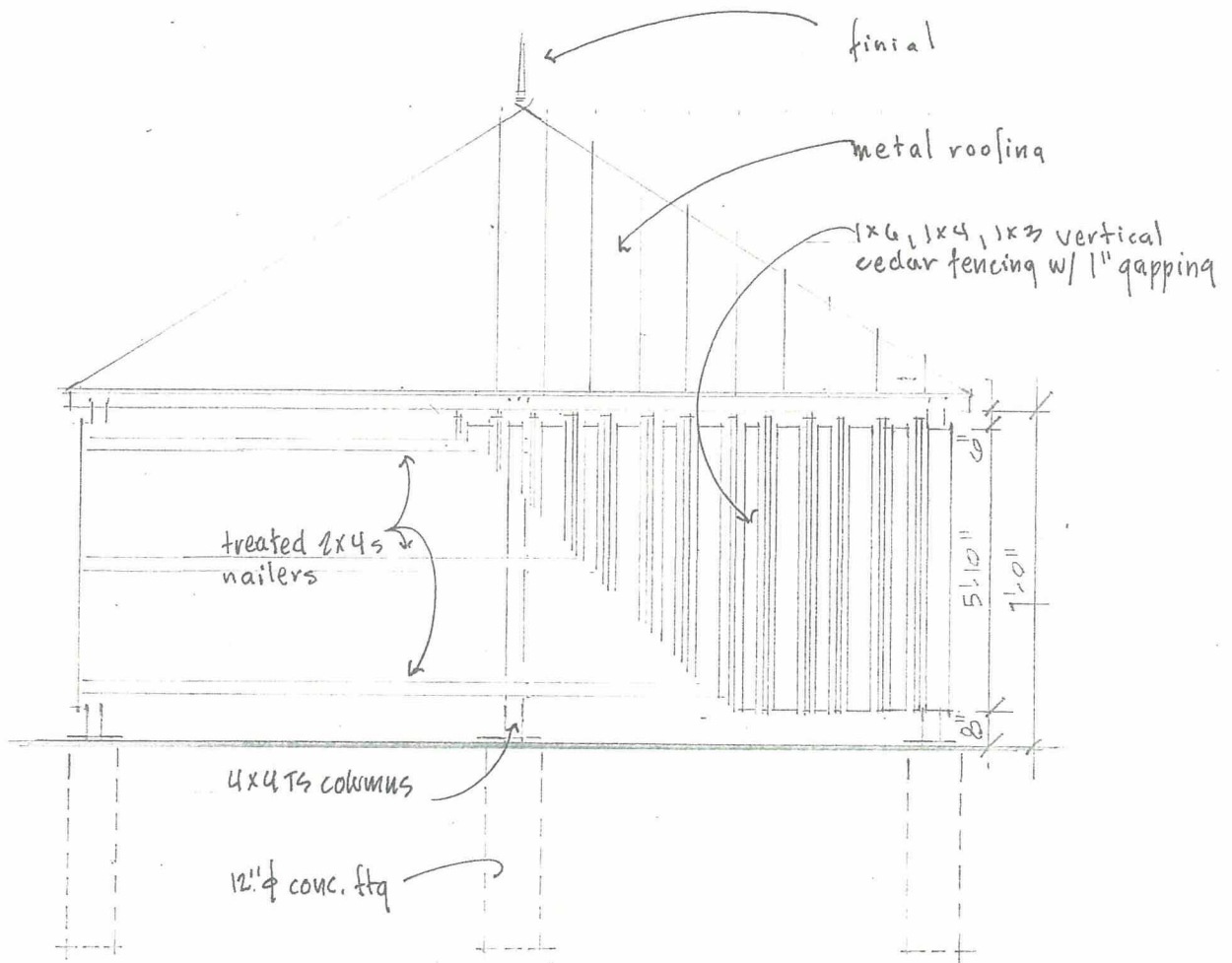

403 • SIDE ELEVATION • CARPORT @ 1/4" = 1'-0" #12

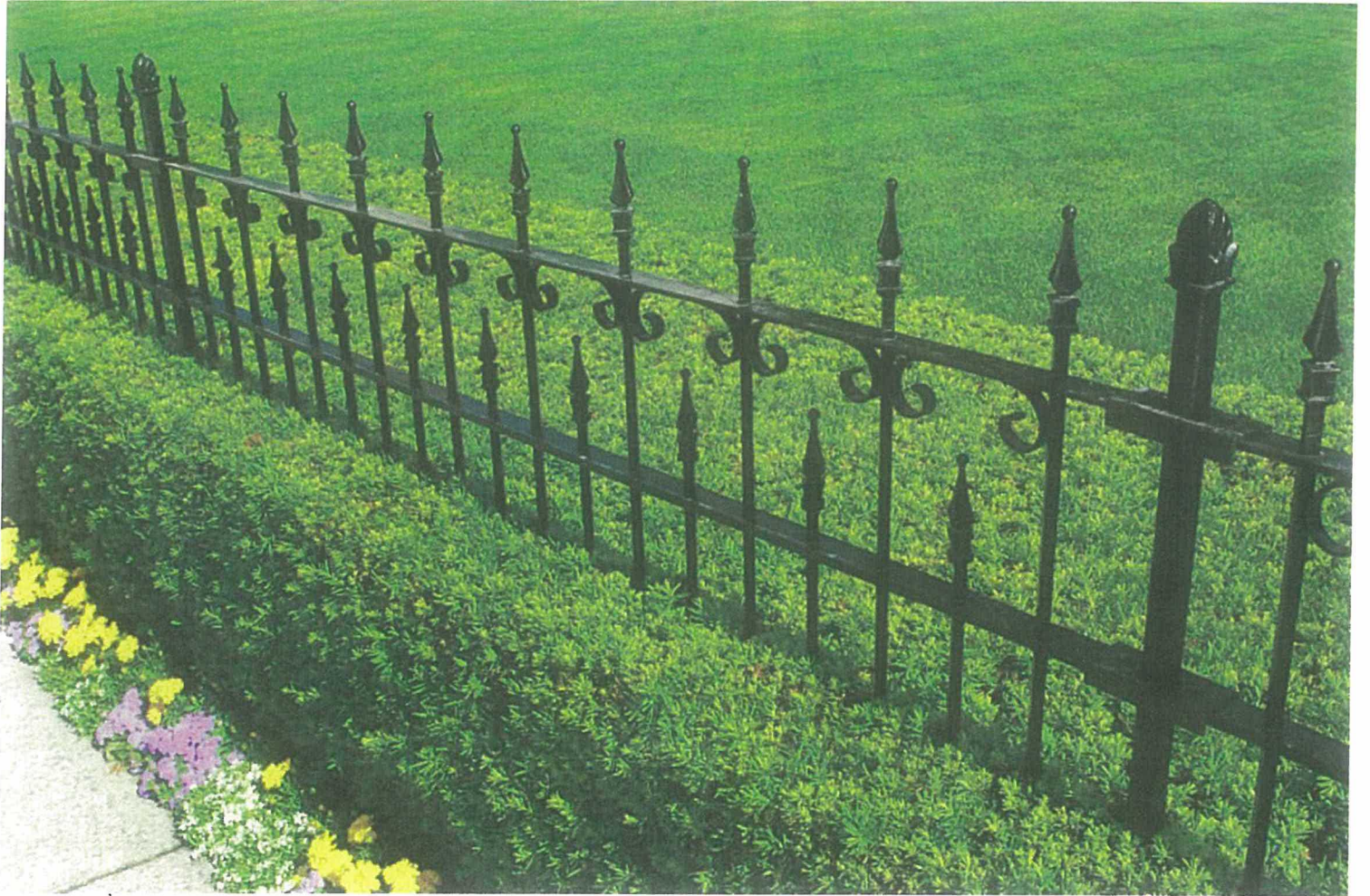

403 W. LIBERTY • WROUGHT IRON FENCE & LANDSCAPING TREATMENT #13



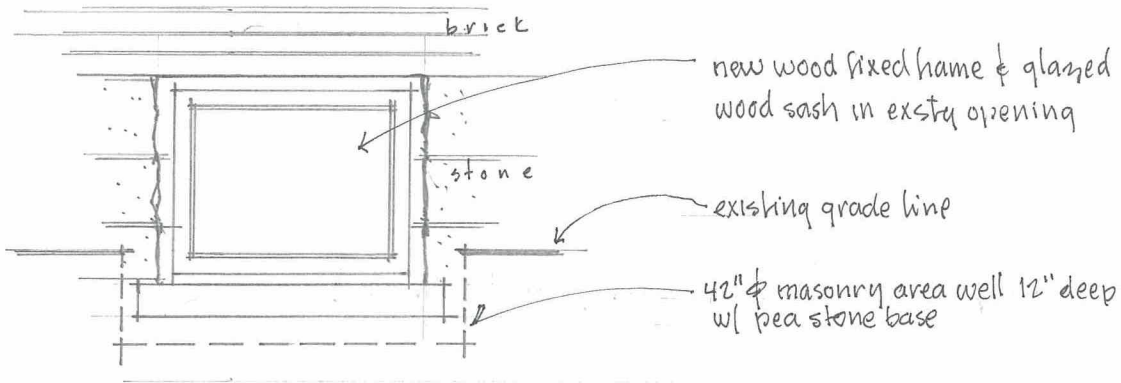

NORTH ° RESTORE EXISTING FIXED WINDOW

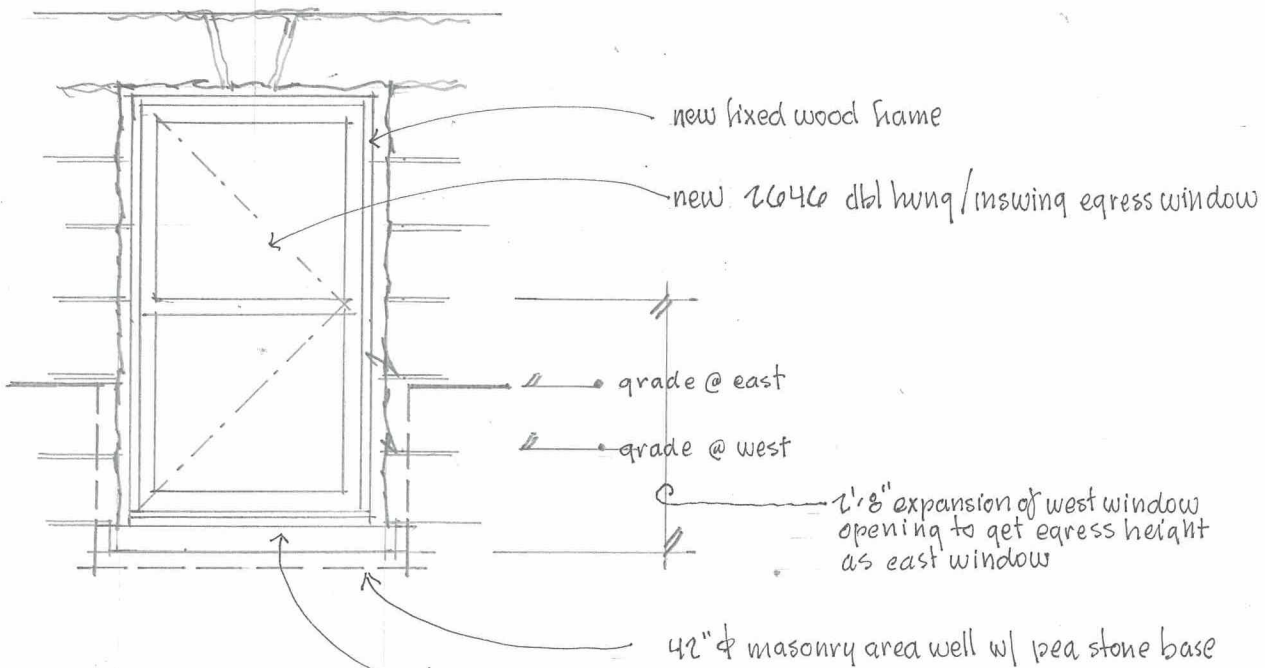

EAST  
WEST

OPENING EXS'TG  
OPENING ENLARGED VERTICALLY (down)

relocate stone sill @ west window

403 W. LIBERTY ° BASEMENT WINDOW FIX DETAILS ° 2.2.2018