

PUBLIC IMPROVEMENT REQUEST FOR PROPOSAL

RFP# 24-05

2024 Sidewalk Replacements Repair

City of Ann Arbor
Public Services Area / Engineering Unit



Due Date: February 14, 2024 by 11:00 a.m. (local time)

Issued By:

City of Ann Arbor
Procurement Unit
301 E. Huron Street
Ann Arbor, MI 48104

ADDENDUM No. 1

RFP No. 24-05

2024 Sidewalk Replacements Repair

Due Date: February 14, 2024 by 11:00 a.m. (local time)

The information contained herein shall take precedence over the original documents and all previous addenda (if any) and is appended thereto. **This Addendum includes a total of 5 pages.**

The Proposer is to acknowledge **receipt of this Addendum No. 1 by signing and submitting attachment B**, including all attachments in its Proposal by so indicating in the proposal that the addendum has been received. Proposals submitted without acknowledgement of receipt of this addendum may be considered non-conforming.

The following forms provided within the RFP Document should be included in submitted proposal:

- **Attachment D - Prevailing Wage Declaration of Compliance**
- **Attachment E - Living Wage Declaration of Compliance**
- **Attachment G - Vendor Conflict of Interest Disclosure Form**
- **Attachment H - Non-Discrimination Declaration of Compliance**

Proposals that fail to provide these completed forms listed above upon proposal opening may be rejected as non-responsive and may not be considered for award.

I. CORRECTIONS/ADDITIONS/DELETIONS

Changes to the RFP documents which are outlined below are referenced to a page or Section in which they appear conspicuously. Offerors are to take note in its review of the documents and include these changes as they may affect work or details in other areas not specifically referenced here.

Section/Page(s)	Change
Section I. K. Wage Determination	The wage determination General Decision Number: MI20240001, dated 01/05/2024, applies to this contract.
Add#1- 2-5	Pre-Bid/Proposal Meeting 2024.02.06 Minutes

Offerors are responsible for any conclusions that they may draw from the information contained in the Addendum.

**Pre-Bid/Proposal Meeting Minutes for the
2024 Annual Sidewalk Replacements Repair**

February 6, 2024 2:00 p.m. TEAMS meeting and Phone Conference ID: 600 578 901#

I. Introduction of Project

- a. Sidewalk Repair Program described on the City's website: www.a2gov.org/sidewalk, all areas 2024. Use of millage money to maintain safe sidewalks. Program is split so 1/5 is done each year. It started in 2012, making this the third time through this area.
- b. Primarily removal and replacement of 1 (or more) sidewalk flags, identified by City's inspectors, which are marked and tallied for contractor's use.
- c. Additional sidewalk flags will be identified outside the 2024 Areas, as brought to our attention.
- d. New ramps are included in the project. (Not 2024 area specific.)
- e. Pedestrian pole foundations are included in the project.
- f. Other miscellaneous concrete may be added/negotiated.

II. General

- a. Bids are due February 14, by 11:00 a.m.
- b. **Proposal Requirements:** Refer to the Request for Proposal 24-05 (RFP), Section III. Minimum Information Required. The proposals are scored according to the information submitted.
- c. Specifications:
 - i. Public Works Standard Specifications (2024) Articles 1, 5, 6, 7, 10, 11, 12
 - ii. Detailed Specifications in the RFP is amendment to Standard Specifications. **They are not intended to include all requirements.**
- d. Project Schedule
 - i. Proposal Review, Intent to Award, Insurance and Bonds, City Council Award, Assess Areas for needed repairs, Notice to Proceed. Could start as early as April 15.
 - ii. Milestone Completion Dates: Refer to the RFP Detailed Specification for Project Schedule.

III. Construction Expectations

- a. Refer to **RFP# 24-05, Section II. D. Operational Requirements and Expectations**. Below are some highlights.
- b. Communication with City Inspector every day. At a minimum, they will need to know work plans for the day to provide inspection. In addition, the schedule of work in the immediate future should also be relayed, to ensure that protocols (e.g. traffic control and notification requirements) are being followed.
- c. The contractor should expect the work to be scattered among several streets of each area every day.
- d. A schedule is presented to the contractor as to which areas and which ramps are prioritized. This can be discussed further and the contractor can present their case as to how and why our schedule should be changed to benefit the sidewalk program.

- e. There is a miscellaneous repair list which will be put on a map and will be given to the foreman. Miscellaneous repairs can be done when other work is close, for efficiency. However, at times, miscellaneous locations may be prioritized.
- f. Work Requirements:
 - i. We expect that the contractor will only remove enough concrete sidewalk flags as they are replacing on the same day.
 - ii. All base/sub-base repairs will be completed and inspected before pouring concrete in all areas.
 - iii. All tree roots will be evaluated before they are disturbed. All roots smaller than 2 inches in diameter can be cut out to accommodate the installation of sidewalk. Any roots larger than 2 inches in diameter will be referred to the Forestry Division of the City of Ann Arbor to assess before work can begin.
 - iv. All restoration will be completed on the following day of the sidewalk/ramp installation, before moving on to new locations of sidewalk for repairs.
 - v. Restoration includes topsoil and seed, removal of forms, clean up, and removal of all vehicle and pedestrian traffic control signs.
 - vi. Bituminous pavement restoration is to be scheduled for every Friday after a ramp or ramps have been installed and completed. A period of at least 3 days is needed for the concrete to cure before the adjacent pavement is restored.
 - vii. Material testing will be done by an independent tester hired by the City of Ann Arbor.
 - viii. There will be an inspector on site at all times to keep count of quantity and quality of production. There will be a daily quantity sheet to be filled out by the inspector and signed by the foreman of the crew, when agreed upon.
 - ix. Wage rate interviews will be performed by the Inspector in accordance with the City's Prevailing Wage ordinance and policy.
- g. Permits/Site Requirements
 - i. Traffic Control is the responsibility of the contractor. All traffic personnel and devices will be provided by the contractor and will abide by all MMUTCD rules and regulations.
 - ii. Parking meters may be need to be reserved for work site. This will be coordinated with the City Inspector.
 - iii. A citywide Right of Way permit will be applied for by the contractor, but the fees will not be incurred by the contractor.
 - iv. A lane closure permit is required for closure of a traffic lane on all major streets, and some local streets. This permit will be applied for by the contractor online, but the fees will not be incurred by the contractor. The contractor will abide by all City of Ann Arbor as well as MMUTCD rules and regulations.
 - v. There may be sidewalk repairs needed along MDOT business routes. The contractor will need to obtain MDOT lane closures and R.O.W permits for these roads.
- h. There will be no work on national holidays or Sundays. Saturday work is permitted with 48-hour notification. Additionally, Ann Arbor Art Fair, U of M home football games and other events are considered holidays within the immediate vicinities.

IV. Addendum Items

- a. Addendum #1 – will include the following:
 - i. Pre-Bid minutes, including Sign-in Sheet
 - ii. Submitted Questions with Answers
 - iii. Applicable wage determination
 - iv. Any revisions to the bid documents or specifications that are warranted

Written Question Deadline February 8, 2024, 9:00 a.m. (Local Time)

Addendum Published (if needed) February 9, 2024

Proposal Due Date February 14, 2024, 11:00 a.m. (Local Time)

V. Questions?

Contact Information and Minutes Prepared By:

Theresa Bridges

Project Manager

Phone: (734) 794-6410 ext. 43672

E-mail: tbridges@a2gov.org

1. Summary

Meeting title	Pre-Proposal 2024 Sidewalk Replacements Repair Project
Attended participants	5
Start time	2/06/24, 1:49:31 PM
End time	2/06/24, 2:18:36 PM
Meeting duration	29m 5s
Average attendance time	16m 12s

2. Participants

Name	First Join	Last Leave	In-Meeting	Email	Participant Role
Bridges, Theresa	2/06/24, 2	2/06/24, 2	17m 55s	TBridges@	TBridges@ Organizer
Ground Control Property Services	2/06/24, 2	2/06/24, 2	17m 46s		Presenter
Ronny Audia	2/06/24, 2	2/06/24, 2	17m 43s		Presenter
John Senkowski	2/06/24, 2	2/06/24, 2	17m 43s		Presenter
Alsaidy, Al	2/06/24, 2	2/06/24, 2	9m 54s	AAlsaidy@	AAlsaidy@ Presenter

3. In-Meeting Activities

Name	Join Time	Leave Time	Duration	Email	Role
Bridges, Theresa	2/06/24, 2	2/06/24, 2	17m 55s	TBridges@	Organizer
Ground Control Property Services	2/06/24, 2	2/06/24, 2	17m 46s		Presenter
Ronny Audia	2/06/24, 2	2/06/24, 2	17m 43s		Presenter
John Senkowski	2/06/24, 2	2/06/24, 2	17m 43s		Presenter
Alsaidy, Al	2/06/24, 2	2/06/24, 2	9m 54s	AAlsaidy@	Presenter

TABLE OF CONTENTS

SECTION I: GENERAL INFORMATION3

SECTION II: SCOPE OF WORK..... 10

SECTION III: MINIMUM INFORMATION REQUIRED 17

SECTION IV: ATTACHMENTS 23

APPENDIX A: AREA MAPS

SECTION I - GENERAL INFORMATION

A. OBJECTIVE

The purpose of this Request for Proposal (RFP) is to select a Contractor to provide construction services for the 2024 Sidewalk Replacements Repair project, which includes removal and replacement of existing concrete sidewalk slabs and installation of new curb ramps and miscellaneous concrete items.

B. BID SECURITY

Each bid must be accompanied by a certified check or Bid Bond by a surety licensed and authorized to do business within the State of Michigan, in the amount of 5% of the total of the bid price.

Proposals that fail to provide a bid security upon proposal opening will be deemed non-responsive and will not be considered for award.

C. QUESTIONS AND CLARIFICATIONS / DESIGNATED CITY CONTACTS

All questions regarding this Request for Proposal (RFP) shall be submitted via e-mail. Questions will be accepted and answered in accordance with the terms and conditions of this RFP.

All questions shall be submitted on or before February 8, 2024 at 9:00 a.m. (local time), and should be addressed as follows:

Scope of Work/Proposal Content questions shall be e-mailed to **Theresa Bridges, Project Manager** - tbridges@a2gov.org.

RFP Process and Compliance questions shall be e-mailed to Colin Spencer, Buyer - CSpencer@a2gov.org

Should any prospective bidder be in doubt as to the true meaning of any portion of this RFP, or should the prospective bidder find any ambiguity, inconsistency, or omission therein, the prospective bidder shall make a written request for an official interpretation or correction by the due date for questions above.

All interpretations, corrections, or additions to this RFP will be made only as an official addendum that will be posted to a2gov.org and MITN.info and it shall be the prospective bidder's responsibility to ensure they have received all addenda before submitting a proposal. Any addendum issued by the City shall become part of the RFP, and must be incorporated in the proposal where applicable.

D. PRE-PROPOSAL MEETING

A pre-proposal meeting for this project will be held on **February 6, 2024 at 2:00 p.m.**

WHERE: This meeting will be held virtually through Microsoft Teams. Interested parties can contact the Project Manager, Theresa Bridges (tbridges@a2gov.org) to receive an invitation, or use the following Microsoft Teams meeting information:

Microsoft Teams meeting

Join on your computer, mobile app or room device

[Click here to join the meeting](#)

Meeting ID: 236 138 392 106

Passcode: hHfLFb

[Download Teams](#) | [Join on the web](#)

Or call in (audio only)

[+1 734-412-6317,,600578901#](#) United States, Ann Arbor

Phone Conference ID: 600 578 901#

Attendance at this meeting is highly recommended. Administrative and technical questions regarding this project will be answered at this time. The pre-proposal conference is for information only. Any answers furnished will not be official until verified in writing by the Financial Service Area, Procurement Unit. Answers that change or substantially clarify the proposal will be affirmed in an addendum.

E. PROPOSAL FORMAT

To be considered, each firm must submit a response to this RFP using the format provided in Section III. No other distribution of proposals is to be made by the prospective bidder. An official authorized to bind the bidder to its provisions must sign the proposal. Each proposal must remain valid for at least one hundred and twenty (120) days from the due date of this RFP.

Proposals should be prepared simply and economically providing a straightforward, concise description of the bidder's ability to meet the requirements of the RFP. No erasures are permitted. Mistakes may be crossed out and corrected and must be initialed in ink by the person signing the proposal.

F. SELECTION CRITERIA

Responses to this RFP will be evaluated using a point system as shown in Section III. A selection committee comprised primarily of staff from the City will complete the evaluation.

All proposals submitted may be subject to clarifications and further negotiation. All agreements resulting from negotiations that differ from what is represented within the RFP or in the proposal response shall be documented and included as part of the final contract.

G. SEALED PROPOSAL SUBMISSION

All proposals are due and must be delivered to the City on or before February 14, 2024 by 11:00 a.m. (local time). Proposals submitted late or via oral, telephonic, telegraphic, electronic mail or facsimile **will not** be considered or accepted.

Each respondent should submit in a sealed envelope

- **one (1) original proposal**
- **one (1) additional proposal copy**
- **one (1) digital copy of the proposal preferably on a USB/flash drive as one file in PDF format**

Proposals submitted should be clearly marked: **“RFP No. 24-05 – 2024 SIDEWALK REPLACEMENTS REPAIR”** and list the bidder’s name and address.

Proposals must be addressed and delivered to:
City of Ann Arbor
c/o Customer Service
301 East Huron Street
Ann Arbor, MI 48107

All proposals received on or before the due date will be publicly opened and recorded on the due date. No immediate decisions will be rendered.

Hand delivered proposals may be dropped off in the Purchasing drop box located in the Ann Street (north) vestibule/entrance of City Hall which is open to the public Monday through Friday from 8am to 5pm (except holidays). The City will not be liable to any prospective bidder for any unforeseen circumstances, delivery, or postal delays. Postmarking on the due date will not substitute for receipt of the proposal.

Bidders are responsible for submission of their proposal. Additional time will not be granted to a single prospective bidder. However, additional time may be granted to all prospective bidders at the discretion of the City.

A proposal may be disqualified if the following required forms are not included with the proposal:

- **Attachment D - Prevailing Wage Declaration of Compliance**
- **Attachment E - Living Wage Declaration of Compliance**
- **Attachment G - Vendor Conflict of Interest Disclosure Form**
- **Attachment H - Non-Discrimination Declaration of Compliance**

Proposals that fail to provide these forms listed above upon proposal opening may be deemed non-responsive and may not be considered for award.

H. DISCLOSURES

Under the Freedom of Information Act (Public Act 442), the City is obligated to permit review of its files, if requested by others. All information in a proposal is subject to disclosure under this provision. This act also provides for a complete disclosure of contracts and attachments thereto.

I. TYPE OF CONTRACT

A sample of the Construction Agreement is included as Attachment A. Those who wish to submit a proposal to the City are required to review this sample agreement carefully. **The City will not entertain changes to its Construction Agreement.**

For all construction work, the respondent must further adhere to the City of Ann Arbor General Conditions. The General Conditions are included herein. Retainage will be held as necessary based on individual tasks and not on the total contract value. The Contractor shall provide the required bonds included in the Contract Documents for the duration of the Contract.

The City reserves the right to award the total proposal, to reject any or all proposals in whole or in part, and to waive any informality or technical defects if, in the City's sole judgment, the best interests of the City will be so served.

This RFP and the selected bidder's response thereto, shall constitute the basis of the scope of services in the contract by reference.

J. NONDISCRIMINATION

All bidders proposing to do business with the City shall satisfy the contract compliance administrative policy adopted by the City Administrator in accordance with the Section 9:158 of the Ann Arbor City Code. Breach of the obligation not to discriminate as outlined in Attachment G shall be a material breach of the contract. Contractors are required to post a copy of Ann Arbor's Non-Discrimination Ordinance attached at all work locations where its employees provide services under a contract with the City.

K. WAGE REQUIREMENTS

The Attachments provided herein outline the requirements for payment of prevailing wages or of a “living wage” to employees providing service to the City under this contract. The successful bidder must comply with all applicable requirements and provide documentary proof of compliance when requested.

Pursuant to Resolution R-16-469 all public improvement contractors are subject to prevailing wage and will be required to provide to the City payroll records sufficient to demonstrate compliance with the prevailing wage requirements. Use of Michigan Department of Transportation Prevailing Wage Forms (sample attached hereto) or a City-approved equivalent will be required along with wage rate interviews.

For laborers whose wage level are subject to federal, state and/or local prevailing wage law the appropriate Davis-Bacon wage rate classification is identified based upon the work including within this contract. **The wage determination(s) current on the date 10 days before proposals are due shall apply to this contract.** The U.S. Department of Labor (DOL) has provided explanations to assist with classification in the following resource link: www.wdol.gov.

For the purposes of this RFP the Construction Type of Highway will apply.

L. CONFLICT OF INTEREST DISCLOSURE

The City of Ann Arbor Purchasing Policy requires that the consultant complete a Conflict of Interest Disclosure form. A contract may not be awarded to the selected bidder unless and until the Procurement Unit and the City Administrator have reviewed the Disclosure form and determined that no conflict exists under applicable federal, state, or local law or administrative regulation. Not every relationship or situation disclosed on the Disclosure Form may be a disqualifying conflict. Depending on applicable law and regulations, some contracts may awarded on the recommendation of the City Administrator after full disclosure, where such action is allowed by law, if demonstrated competitive pricing exists and/or it is determined the award is in the best interest of the City. A copy of the Conflict of Interest Disclosure Form is attached.

M. COST LIABILITY

The City of Ann Arbor assumes no responsibility or liability for costs incurred by the bidder prior to the execution of an Agreement. The liability of the City is limited to the terms and conditions outlined in the Agreement. By submitting a proposal, bidder agrees to bear all costs incurred or related to the preparation, submission, and selection process for the proposal.

N. DEBARMENT

Submission of a proposal in response to this RFP is certification that the Respondent is not currently debarred, suspended, proposed for debarment, and declared ineligible or voluntarily excluded from participation in this transaction by any State or Federal departments or agency. Submission is also agreement that the City will be notified of any changes in this status.

O. PROPOSAL PROTEST

All proposal protests must be in writing and filed with the Purchasing Manager within five (5) business days of any notices of intent, including, but not exclusively, divisions on prequalification of bidders, shortlisting of bidders, or a notice of intent to award. Only bidders who responded to the solicitation may file a bid protest. The bidder must clearly state the reasons for the protest. If any bidder contacts a City Service Area/Unit and indicates a desire to protest an award, the Service Area/Unit shall refer the bidder to the Purchasing Manager. The Purchasing Manager will provide the bidder with the appropriate instructions for filing the protest. The protest shall be reviewed by the City Administrator or designee, whose decision shall be final.

Any inquiries or requests regarding this procurement should be only submitted in writing to the Designated City Contacts provided herein. Attempts by the bidder to initiate contact with anyone other than the Designated City Contacts provided herein that the bidder believes can influence the procurement decision, e.g., Elected Officials, City Administrator, Selection Committee Members, Appointed Committee Members, etc., may lead to immediate elimination from further consideration.

P. SCHEDULE

The following is the schedule for this RFP process.

Activity/Event	Anticipated Date
Pre-Proposal Meeting	February 6, 2024, 2:00 p.m. (Local Time)
Written Question Deadline	February 8, 2024, 9:00 a.m. (Local Time)
Addendum Published (if needed)	February 9, 2024
Proposal Due Date	February 14, 2024, 11:00 a.m. (Local Time)
Expected City Council Authorizations	March 18, 2024

The above schedule is for information purposes only and is subject to change at the City’s discretion.

Q. IRS FORM W-9

The selected bidder will be required to provide the City of Ann Arbor an IRS form W-9.

R. RESERVATION OF RIGHTS

1. The City reserves the right in its sole and absolute discretion to accept or reject any or all proposals, or alternative proposals, in whole or in part, with or without cause.
2. The City reserves the right to waive, or not waive, informalities or irregularities in terms or conditions of any proposal if determined by the City to be in its best interest.
3. The City reserves the right to request additional information from any or all bidders.
4. The City reserves the right to reject any proposal that it determines to be unresponsive and deficient in any of the information requested within RFP.
5. The City reserves the right to determine whether the scope of the project will be entirely as described in the RFP, a portion of the scope, or a revised scope be implemented.
6. The City reserves the right to select one or more contractors or service providers to perform services.
7. The City reserves the right to retain all proposals submitted and to use any ideas in a proposal regardless of whether that proposal is selected. Submission of a proposal indicates acceptance by the firm of the conditions contained in this RFP, unless clearly and specifically noted in the proposal submitted.
8. The City reserves the right to disqualify proposals that fail to respond to any requirements outlined in the RFP, or failure to enclose copies of the required documents outlined within the RFP.

S. IDLEFREE ORDINANCE

The City of Ann Arbor adopted an idling reduction Ordinance that went into effect July 1, 2017. The full text of the ordinance (including exemptions) can be found at: www.a2gov.org/idlefree.

Under the ordinance, No Operator of a Commercial Vehicle shall cause or permit the Commercial Vehicle to Idle:

- (a) For any period of time while the Commercial Vehicle is unoccupied; or
- (b) For more than 5 minutes in any 60-minute period while the Commercial Vehicle is occupied.

In addition, generators and other internal combustion engines are covered

- (1) Excluding Motor Vehicle engines, no internal combustion engine shall be operated except when it is providing power or electrical energy to equipment or a tool that is actively in use.

T. ENVIRONMENTAL COMMITMENT

The City of Ann Arbor recognizes its responsibility to minimize negative impacts on human health and the environment while supporting a vibrant community and economy. The City further recognizes that the products and services the City buys

have inherent environmental and economic impacts and that the City should make procurement decisions that embody, promote, and encourage the City's commitment to the environment.

The City encourages potential vendors to bring forward emerging and progressive products and services that are best suited to the City's environmental principles.

U. MAJOR SUBCONTRACTORS

The Bidder shall identify each major subcontractor it expects to engage for this Contract if the work to be subcontracted is 15% or more of the bid sum or over \$50,000, whichever is less. The Bidder also shall identify the work to be subcontracted to each major subcontractor. The Bidder shall not change or replace a subcontractor without approval by the City.

N. LIQUIDATED DAMAGES

A liquidated damages clause, as given on page C-2, Article III of the Contract, provides that the Contractor shall pay the City as liquidated damages, and not as a penalty, a sum certain per day for each and every day that the Contractor may be in default of completion of the specified work, within the times stated in the Contract, or written extensions.

Liquidated damages clauses, as given in the General Conditions, provide further that the City shall be entitled to impose and recover liquidated damages for breach of the obligations under Chapter 112 of the City Code.

The liquidated damages are for the non-quantifiable aspects of any of the previously identified events and do not cover actual damages that can be shown or quantified nor are they intended to preclude recovery of actual damages in addition to the recovery of liquidated damages.

SECTION II - SCOPE OF WORK

A. Objective

The City of Ann Arbor, Michigan, is requesting proposals from construction firms able to provide concrete sidewalk repairs, as well as install miscellaneous improvements, to its non-motorized infrastructure, as needed for the Sidewalk Repair Program (www.a2gov.org/sidewalk). Much of the work involves removing existing sidewalk flags in disrepair, as identified by the Engineer, and installing concrete sidewalk in its place, with appropriate adjacent restoration. In addition, the work includes installing new curb ramps, pedestrian signal cylindrical foundations, and potentially other miscellaneous concrete installations.

B. Contract Implementation

The term of the contract will be for a one-year period, starting from the Notice to Proceed, with an option to extend the contract for two (2) additional one-year periods, subject to agreement by the City and the Contractor. Extensions to the contract will include modifications to the Project Schedule Detailed Specification and the Concrete Sidewalk Area maps. Any extension of the Contract will be at the same terms and conditions, including the same Schedule of Pricing/Cost, as in the original Contract.

C. Project Overview

Each year, approximately 20% of the City's sidewalk is divided into 4 (or 5) Concrete Sidewalk areas as detailed in Appendix A. The City will provide the lists of specific areas needing repairs, maps of said areas, inspection to oversee repairs, and material testing services.

Contractor will take direction from the City's representatives on work to be completed; provide crews that are qualified, well-staffed and well-equipped that follow and conform to City policies and procedures described herein; and complete quality work in a safe manner.

The typical work to be assigned by the City includes removal and replacement of damaged sidewalk flags or ramps within the designated 2024 areas, installation of new curb ramps and associated sidewalk, miscellaneous removal and replacement of damaged sidewalk flags or ramps, and installation of pedestrian signal pole foundations throughout the City. Creation of new concrete bump outs and/or other miscellaneous concrete work may be added.

A list and map of an assessed area's replacement locations will be provided, as well as be marked in the field, by City inspection staff at least one week prior to starting the area, but any miscellaneous repairs may be prioritized at any time. City staff will work with the Contractor to schedule these repairs in a manner that maximizes efficiency, where possible and if repairs are not deemed urgent.

D. Operational Requirements and Expectations

1. Communication between contractor foremen/superintendent and inspection staff is critical. Check in with inspection staff every morning to discuss locations and scope of work for the day. Any work completed without presence of inspection staff may be rejected.
2. The Contractor should expect the work to be scattered among several streets within an area every day. City staff may assist in logistical planning of the day's work, but are not obligated to do so.
3. The City will prioritize miscellaneous work as needed, and it may not be limited to the current area of work.
4. Ensure that all work scheduled for the day can be completed within the restrictions specified herein, including City holidays, Sundays, Saturdays as permitted, and specified areas near major events.
5. Stage equipment and materials only in pre-approved areas, to be discussed first with inspection staff as to location and procedures. No materials or equipment can be placed in the City's right-of-way without prior approval from City staff, and none can be placed on private property at any time.
6. Ensure that all proper permitting has been issued, and in hand. The Contractor shall apply online (<https://stream.a2gov.org>) and the fees for will be internally funded. Inspection staff can assist in traversing the permitting process. The contractor shall abide by all City of Ann Arbor as well as MMUTCD rules and regulations. Note that major streets have more requirements than local street.
 - A citywide Right-of-Way Permit.
 - Lane Closure Permits for all locations requiring the closure of a traffic lane on all major streets, and some local streets.
 - A Barricade Permitting, where directed by City staff.
 - Permit to Reserve Parking for occupancy of parking spaces which are not metered shall be obtained a minimum of 5 days prior to date of need.
 - MDOT Right-of-Way and Lane Closure Permits for sidewalk repairs along MDOT business routes
7. Ensure that driveway inaccessibility notifications have been distributed properly prior to work taking place.

- 24-hour notice or more to residents
 - Contact each business with a minimum of 24-hour notice
8. Ensure all necessary vehicular and pedestrian traffic control devices are on-hand and in good condition before start of work. Contractor shall set up appropriate traffic control devices before beginning any work, including, but not limited to, Type II barricades and pedestrian detours.
 9. Ensure that flagging staff and equipment are on-hand and in good condition if needed that day.
 10. Ensure that any parking areas that will be occupied are accounted for appropriately.
 11. Coordinate in advance with City staff any areas of work that will affect business traffic or take place in dense residential zones to ensure public safety and minimum disruption. Such critical areas include, but are not limited to, University of Michigan, Downtown District, School zones, and Kerrytown.
 12. Remove only concrete that will be replaced the same day.
 13. Inspection staff need to verify that subbase is in acceptable condition. Subbase repairs, as required, must be completed prior to pouring of concrete in all areas.
 14. While preparing areas to allow for installation of forms and subbase preparation, any roots 2" or larger can be referred to the Forestry Division to assess if they can be cut.
 15. City's pre-pour inspection includes, but is not limited to, the following: subbase condition, depth and shape of forms, and condition of adjacent slabs.
 16. Contractor must furnish the contract specified pre-approved concrete mix, and provide delivery ticket with each truck/load brought on site. Excessive length of delivery time, over-mixing, adding more water than allowed, and superfluous additives are examples of rejectable concrete.
 17. City will provide material testing services, conducted by independent testing entities. Contractor should work with testers to provide concrete as needed.
 18. Contractor will not pour in rain conditions; inspection staff may pause or cancel work for the day due to rain activities.
 19. Concrete poured in temperatures below 50 degrees F should be done in accordance with City specifications.

20. Concrete curing compound will need to be applied in accordance with City specifications.
21. Before starting new areas, any completed areas need to be inspected for quality of finish the following day, and then properly restored and cleaned up, which includes removal of forms, clean-up of all debris, topsoil and seed, and removal of all vehicle and pedestrian traffic control.
22. Any work completed will be accounted for by inspection staff. There will be an inspector on site at all times to keep count of quantity and quality of production. There will be a daily quantity sheet to be filled out by the inspector and signed by the foreman of the crew, when agreed upon.
23. When concrete work is completed and areas are opened up to the public, this work will be subject to a final inspection. City staff will provide the contractor with a punchlist, outlining any work that needs to be addressed, to be completed as specified in the Project Schedule Detailed Specification.

E. Standard Specifications

All work performed under this Contract shall be performed in accordance with the 2024 Public Services Standard Specifications. All work under this Contract which is not included in these Standard Specifications, or which is performed using modifications to these Standard Specifications, shall be performed in accordance with the Detailed Specifications included in these contract documents.

Copies of the Standard Specifications can be downloaded from the following web link.

<https://www.a2gov.org/departments/engineering/Pages/Engineering-and-Contractor-Resources.aspx>

F. Detailed Specifications – Located within Attachment A, Sample Standard Contract

Project Schedule.....	DS-1
01040.70 Traffic Control, Max \$7,500.....	DS-3
03002.70 Sidewalk Grading.....	DS-6
08110.70 Concrete Curb or Curb & Gutter, All Types.....	DS-7
08111.70 Concrete Curb or Curb & Gutter, All Types, High Early	DS-7
08130.71 4-Inch Concrete Sidewalk	DS-8
08131.71 6-Inch Concrete Sidewalk, Driveway, Ramp.....	DS-8
08132.71 6-Inch Concrete Sidewalk, Driveway, Ramp – High Early	DS-8
08133.71 8-inch Conc. Sidewalk, Driveway, Ramp, Fibermesh - High Early.....	DS-8
08135.71 Integral Sidewalk Retaining Wall (7" or Less)	DS-10
08135.72 Integral Sidewalk Retaining Wall (7" - 18")	DS-10
08135.73 Integral Sidewalk Retaining Wall (19" - 36")	DS-10
08301.70 Adjust Monument, Valve, or Curb Box.....	DS-14
08302.70 Adjust Handhole	DS-14
08303.70 Adjust Storm Structure Cover	DS-14
08304.70 Adjust Storm Inlet Cover.....	DS-14
09055.70 Pedestrian Signal Pole Foundation.....	DS-15
10060.70 Turf Restoration	DS-17

SECTION III - MINIMUM INFORMATION REQUIRED

PROPOSAL FORMAT

The following describes the elements that should be included in each of the proposal sections and the weighted point system that will be used for evaluation of the proposals.

Bidders should organize Proposals into the following Sections:

- A. Qualifications, Experience and Accountability
- B. Workplace Safety
- C. Workforce Development
- D. Social Equity and Sustainability
- E. Schedule of Pricing/Cost
- F. Authorized Negotiator
- G. Attachments

Bidders are strongly encouraged to provide details for all of the information requested below within initial proposals. Backup documentation may be requested at the sole discretion of the City to validate all of the responses provided herein by bidders. False statements by bidders to any of the criteria provided herein will result in the proposal being considered non-responsive and will not be considered for award.

Pursuant to Sec 1:325 of the City Code which sets forth requirements for evaluating public improvement bids, Bidders should submit the following:

A. Qualifications, Experience and Accountability - 20 Points

1. Qualifications and experience of the bidder and of key persons, management, and supervisory personnel to be assigned by the bidder.
2. References from individuals or entities the bidder has worked for within the last five (5) years including information regarding records of performance and job site cooperation.
3. Evidence of any quality control program used by the bidder and the results of any such program on the bidder's previous projects.
4. A statement from the bidder as to any major subcontractors it expects to engage including the name, work, and amount.

B. Workplace Safety – 20 Points

1. Provide a copy of the bidder's safety program, and evidence of a safety-training program for employees addressing potential hazards of the proposed job site. Bidder must identify a designated qualified safety representative responsible for bidder's safety program who serves as a contact for safety related matters.
2. Provide the bidder's Experience Modification Rating ("EMR") for the last three consecutive years. Preference within this criterion will be given to an EMR of 1.0 or less based on a three-year average.
3. Evidence that all craft labor that will be employed by the bidder for the project has, or will have prior to project commencement, completed at least an authorized 10-hour OSHA Construction Safety Course.
4. For the last three years provide a copy of any documented violations and the bidder's corrective actions as a result of inspections conducted by the Michigan Occupational Safety & Health Administration (MIOSHA), U.S. Department of Labor – Occupational Safety and Health Administration (OSHA), or any other applicable safety agency.

C. Workforce Development – 20 Points

1. Documentation as to bidder's pay rates, health insurance, pension or other retirement benefits, paid leave, or other fringe benefits to its employees.
- 2.. Documentation that the bidder participates in a Registered Apprenticeship Program that is registered with the United States Department of Labor Office of Apprenticeship or by a State Apprenticeship Agency recognized by the USDOL Office of Apprenticeship. USDOL apprenticeship agreements shall be disclosed to the City in the solicitation response.
3. Bidders shall disclose the number of non-craft employees who will work on the project on a 1099 basis, and the bidders shall be awarded points based on their relative reliance on 1099 work arrangements with more points assigned to companies with fewer 1099 arrangements. Bidders will acknowledge that the City may ask them to produce payroll records at points during the project to verify compliance with this section.

D. Social Equity and Sustainability – 20 Points

1. A statement from the bidder as to what percentage of its workforce resides in the City of Ann Arbor and in Washtenaw County, Michigan. The City will consider in

evaluating which bids best serve its interests, the extent to which responsible and qualified bidders employ individuals in the city or the county. Washtenaw County residency is prioritized for evaluation purposes for this solicitation.

2. Evidence of Equal Employment Opportunity Programs for minorities, women, veterans, returning citizens, and small businesses.
3. Evidence that the bidder is an equal opportunity employer and does not discriminate on the basis of race, sex, pregnancy, age, religion, national origin, marital status, sexual orientation, gender identity or expression, height, weight, or disability.
4. The bidder's proposed use of sustainable products, technologies, or practices for the project, which reduce the impact on human health and the environment, including raw materials acquisition, production, manufacturing, packaging, distribution, reuse, operation, maintenance, and waste management.
5. The bidder's environmental record, including findings of violations and penalties imposed by government agencies.

E. Schedule of Pricing/Cost - 20 Points

Company: _____

ITEM NUMBER	DESCRIPTION	UNIT	ESTIMATED QUANTITY	UNIT PRICE	TOTAL PRICE
01000.00	General Conditions, Max. \$25,000	LS	1	\$	\$
01021.00	Erosion Control, Inlet Protection, Fabric Drop	Ea	2	\$	\$
01040.70	Minor Traffic Control, Max. \$7,500	LS	1	\$	\$
02000.01	Tree, Rem, 5 In. - 10 In.	Ea	1	\$	\$
02020.00	HMA, Any Thickness, Rem	Syd	1,000	\$	\$
02030.00	Curb, Gutter, and Curb and Gutter, Any Type, Rem	Ft	300	\$	\$
02040.00	Sidewalk, Sidewalk Ramp, and Driveway Approach, Any Thickness, Rem	Sft	45,000	\$	\$
03002.70	Sidewalk Grading	Syd	100	\$	\$
03021.00	Subgrade Undercutting, Type II	Cyd	5	\$	\$
03022.00	Subgrade Undercutting, Type III	Cyd	2	\$	\$
08000.00	Subbase, CIP	Cyd	10	\$	\$
08060.00	Hand Patching	Ton	10	\$	\$
08110.70	Conc, Curb or Curb & Gutter, All Types	Ft	250	\$	\$
08111.70	Conc, Curb or Curb & Gutter, All Types, High Early	Ft	50	\$	\$
08130.71	Conc, Sidewalk, 4 In.	Sft	35,000	\$	\$
08131.71	Conc, Sidewalk, Drive Approach, or Ramp, 6 In.	Sft	4,000	\$	\$
08132.71	Conc, Sidewalk, Drive Approach, or Ramp, 6 In., High Early	Sft	2,500	\$	\$
08133.71	Conc, Fibermesh Reinforced, Sidewalk, Drive Approach, or Ramp, 8 In., High Early	Sft	2,500	\$	\$
08135.71	Conc, Integral Sidewalk Retaining Wall (6" or less)	Sft	50	\$	\$
08135.72	Conc, Integral Sidewalk Retaining Wall (7"-18")	Sft	30	\$	\$
08135.73	Conc, Integral Sidewalk Retaining Wall (19" - 36")	Sft	10	\$	\$
08140.00	Brick Pavers, Sidewalk, Rem and Reinstall	Sft	100	\$	\$
08150.00	Detectable Warning Surface	Ft	200	\$	\$
08301.70	Monument, Valve, Curb Box, Adjust	Ea	1	\$	\$
08302.70	Handhole, Adjust	Ea	1	\$	\$
08303.70	Storm Structure Cover, Adjust	Ea	1	\$	\$
08304.70	Storm Inlet Cover, Adjust	Ea	1	\$	\$
09055.70	Foundation, Pedestrian Signal Pole	Ea	10	\$	\$
10060.70	Turf Restoration	Syd	10	\$	\$
XXXXX.7X = Detailed Specification		TOTAL BID AMOUNT		\$	

F. AUTHORIZED NEGOTIATOR / NEGOTIATIBLE ELEMENTS (ALTERNATES)

Include the name, phone number, and e-mail address of persons(s) in your organization authorized to negotiate the agreement with the City.

The proposal price shall include materials and equipment selected from the designated items and manufacturers listed in the bidding documents. This is done to establish uniformity in bidding and to establish standards of quality for the items named.

If the bidder wishes to quote alternate items for consideration by the City, it may do so under this Section. A complete description of the item and the proposed price differential must be provided. Unless approved at the time of award, substitutions where items are specifically named will be considered only as a negotiated change in Contract Sum.

If the Bidder takes exception to the time stipulated in Article III of the Contract, Time of Completion, page C-2, it is requested to stipulate its proposed time for performance of the work.

Consideration for any proposed alternative items or time may be negotiated at the discretion of the City.

G. ATTACHMENTS

General Declaration, Legal Status of Bidder, Conflict of Interest Form, Living Wage Compliance Form, Prevailing Wage Compliance Form and the Non-Discrimination Form should be completed and returned with the proposal. These elements should be included as attachments to the proposal submission.

PROPOSAL EVALUATION

1. The selection committee will evaluate each proposal by the above-described criteria and point system. The City reserves the right to reject any proposal that it determines to be unresponsive and deficient in any of the information requested for evaluation. A proposal with all the requested information does not guarantee the proposing firm to be a candidate for an interview if interviews are selected to be held by the City. The committee may contact references to verify material submitted by the bidder.
2. The committee then will schedule interviews with the selected firms if necessary. The selected firms will be given the opportunity to discuss in more detail their qualifications, past experience, proposed work plan (if applicable) and pricing.
3. The interview should include the project team members expected to work on the project, but no more than six members total. The interview shall consist of a

presentation of up to thirty minutes (or the length provided by the committee) by the bidder, including the person who will be the project manager on this contract, followed by approximately thirty minutes of questions and answers. Audiovisual aids may be used during the oral interviews. The committee may record the oral interviews.

4. The firms interviewed will then be re-evaluated by the above criteria and adjustments to scoring will be made as appropriate. After evaluation of the proposals, further negotiation with the selected firm may be pursued leading to the award of a contract by City Council, if suitable proposals are received.

The City reserves the right to waive the interview process and evaluate the bidder based on their proposal and pricing schedules alone.

The City will determine whether the final scope of the project to be negotiated will be entirely as described in this RFP, a portion of the scope, or a revised scope.

Work to be done under this contract is generally described through the detailed specifications and must be completed fully in accordance with the contract documents.

Any proposal that does not conform fully to these instructions may be rejected.

PREPARATION OF PROPOSALS

Proposals should have no plastic bindings but will not be rejected as non-responsive for being bound. Staples or binder clips are acceptable. Proposals should be printed double sided on recycled paper.

Each person signing the proposal certifies that they are a person in the bidder's firm/organization responsible for the decisions regarding the fees being offered in the Proposal and has not and will not participate in any action contrary to the terms of this provision.

ADDENDA

If it becomes necessary to revise any part of the RFP, notice of the addendum will be posted to Michigan Inter-governmental Trade Network (MITN) www.mitn.info and/or the City of Ann Arbor web site www.A2gov.org for all parties to download.

Each bidder should acknowledge in its proposal all addenda it has received on the General Declarations form provided in the Attachments section herein. The failure of a bidder to receive or acknowledge receipt of any addenda shall not relieve the bidder of the responsibility for complying with the terms thereof. The City will not be bound by oral responses to inquiries or written responses other than official written addenda.

SECTION IV - ATTACHMENTS

Attachment A – Sample Standard Contract

Attachment B – General Declarations

Attachment C - Legal Status of Bidder

Attachment D – Prevailing Wage Declaration of Compliance Form

Attachment E – Living Wage Declaration of Compliance Form

Attachment F – Living Wage Ordinance Poster

Attachment G – Vendor Conflict of Interest Disclosure Form

Attachment H – Non-Discrimination Ordinance Declaration of Compliance Form

Attachment I – Non-Discrimination Ordinance Poster

Sample Certified Payroll Report Template

CONTRACT

THIS CONTRACT is between the CITY OF ANN ARBOR, a Michigan Municipal Corporation, 301 East Huron Street, Ann Arbor, Michigan 48104 ("City") and Doan Construction Co. ("Contractor"), a Michigan corporation, at 3670 Carpenter Road, Ypsilanti, Michigan 48197.

Based upon the mutual promises below, the Contractor and the City agree as follows:

ARTICLE I - Scope of Work

The Contractor agrees to furnish all of the materials, equipment and labor necessary; and to abide by all the duties and responsibilities applicable to it for the project titled **2024 Sidewalk Replacements Repair Project RFP 24-05** in accordance with the requirements and provisions of the following documents, including all written modifications incorporated into any of the documents, all of which are incorporated as part of this Contract:

Non-discrimination and Living Wage Declaration of Compliance Forms (if applicable)	General Conditions
Vendor Conflict of Interest Form	Standard Specifications
Prevailing Wage Declaration of Compliance Form (if applicable)	Detailed Specifications
Bid Forms	Plans
Contract and Exhibits	Addenda
Bonds	

ARTICLE II - Definitions

Administering Service Area/Unit means **Public Services Area/Engineering**

Project means **2024 Sidewalk Replacements Repair Project RFP 24-05**

Supervising Professional means the person acting under the authorization of the manager of the Administering Service Area/Unit. At the time this Contract is executed, the Supervising Professional is: **Theresa Bridges** whose job title is **Project Manager**. If there is any question concerning who the Supervising Professional is, Contractor shall confirm with the manager of the Administering Service Area/Unit.

Contractor's Representative means John Senkowski whose job title is Manager.

ARTICLE III - Time of Completion

- (A) The work to be completed under this Contract shall begin immediately on the date specified in the Notice to Proceed issued by the City.

- (B) The entire work for this Contract shall be completed in accordance with the incremental milestones set forth in the Project Schedule Detailed Specification.
- (C) Failure to complete all the work within the time specified above and herein, including any extension granted in writing by the Supervising Professional, shall obligate the Contractor to pay the City, as liquidated damages and not as a penalty, an amount equal to \$500 for each calendar day of delay in the completion of all the work. If any liquidated damages are unpaid by the Contractor, the City shall be entitled to deduct these unpaid liquidated damages from the monies due the Contractor.

The liquidated damages are for the non-quantifiable aspects of any of the previously identified events and do not cover actual damages that can be shown or quantified nor are they intended to preclude recovery of actual damages in addition to the recovery of liquidated damages.

- (D) The Contract Time specified above is referred to as a one-year period or term. This Contract shall also include an option to extend the contract for up to two (2) additional one-year periods, subject to agreement by the City and the Contractor. An extension of the Contract will be at the same terms and conditions, including the same unit prices, in the original Contract. An extension will be dependent on the availability of funding.

ARTICLE IV - The Contract Sum

The City shall pay to the Contractor for the performance of the Contract, the unit prices as given in the Bid Form for the estimated bid total of:

Seven hundred thirty-seven thousand, six hundred sixty-three Dollars and 02/100 (\$737,663.02)

The amount paid shall be equitably adjusted to cover changes in the work ordered by the Supervising Professional but not required by the Contract Documents. Increases or decreases shall be determined only by written agreement between the City and Contractor.

ARTICLE V - Assignment

This Contract may not be assigned or subcontracted any portion of any right or obligation under this contract without the written consent of the City. Notwithstanding any consent by the City to any assignment, Contractor shall at all times remain bound to all warranties, certifications, indemnifications, promises and performances, however described, as are required of it under this contract unless specifically released from the requirement, in writing, by the City.

ARTICLE VI - Choice of Law

This Contract shall be construed, governed, and enforced in accordance with the laws of the State of Michigan. By executing this Contract, the Contractor and the City agree to venue in a court of appropriate jurisdiction sitting within Washtenaw County for purposes of any action arising under

this Contract. The parties stipulate that the venue referenced in this Contract is for convenience and waive any claim of non-convenience.

Whenever possible, each provision of the Contract will be interpreted in a manner as to be effective and valid under applicable law. The prohibition or invalidity, under applicable law, of any provision will not invalidate the remainder of the Contract.

ARTICLE VII - Relationship of the Parties

The parties of the Contract agree that it is not a Contract of employment but is a Contract to accomplish a specific result. Contractor is an independent Contractor performing services for the City. Nothing contained in this Contract shall be deemed to constitute any other relationship between the City and the Contractor.

Contractor certifies that it has no personal or financial interest in the project other than the compensation it is to receive under the Contract. Contractor certifies that it is not, and shall not become, overdue or in default to the City for any Contract, debt, or any other obligation to the City including real or personal property taxes. City shall have the right to set off any such debt against compensation awarded for services under this Contract.

ARTICLE VIII - Notice

All notices given under this Contract shall be in writing, and shall be by personal delivery or by certified mail with return receipt requested to the parties at their respective addresses as specified in the Contract Documents or other address the Contractor may specify in writing. Notice will be deemed given on the date when one of the following first occur: (1) the date of actual receipt; or (2) three days after mailing certified U.S. mail.

ARTICLE IX - Indemnification

To the fullest extent permitted by law, Contractor shall indemnify, defend and hold the City, its officers, employees and agents harmless from all suits, claims, judgments and expenses including attorney's fees resulting or alleged to result, in whole or in part, from any act or omission, which is in any way connected or associated with this Contract, by the Contractor or anyone acting on the Contractor's behalf under this Contract. Contractor shall not be responsible to indemnify the City for losses or damages caused by or resulting from the City's sole negligence. The provisions of this Article shall survive the expiration or earlier termination of this contract for any reason.

ARTICLE X - Entire Agreement

This Contract represents the entire understanding between the City and the Contractor and it supersedes all prior representations, negotiations, agreements, or understandings whether written or oral. Neither party has relied on any prior representations in entering into this Contract. No terms or conditions of either party's invoice, purchase order or other administrative document shall modify the terms and conditions of this Contract, regardless of the other party's failure to object to such form. This Contract shall be binding on and shall inure to the benefit of the parties to this Contract and their permitted successors and permitted assigns and nothing in this Contract, express or implied, is intended to or shall confer on any other person or entity any legal or equitable right, benefit, or remedy of any nature whatsoever under or by reason of this Contract. This Contract may be altered, amended or modified only by written amendment signed by the City and the Contractor.

ARTICLE XI – Electronic Transactions

The City and Contractor agree that signatures on this Contract may be delivered electronically in lieu of an original signature and agree to treat electronic signatures as original signatures that bind them to this Contract. This Contract may be executed and delivered by facsimile and upon such delivery, the facsimile signature will be deemed to have the same effect as if the original signature had been delivered to the other party.

FOR CONTRACTOR

By _____
John Senkowski
Its: Manager

FOR THE CITY OF ANN ARBOR

By _____
Christopher Taylor, Mayor

By _____
Jacqueline Beaudry, City Clerk

Approved as to substance

By _____
Milton Dohoney Jr.
City Administrator

By _____
Brian Steglitz
Public Services Area Administrator

Approved as to form and content

Atleen Kaur, City Attorney

PERFORMANCE BOND

- (1) _____ of _____ (referred to as "Principal"), and _____, a corporation duly authorized to do business in the State of Michigan (referred to as "Surety"), are bound to the City of Ann Arbor, Michigan (referred to as "City"), for \$ _____, the payment of which Principal and Surety bind themselves, their heirs, executors, administrators, successors and assigns, jointly and severally, by this bond.
- (2) The Principal has entered a written Contract with the City entitled _____ for _____ RFP No. _____ and this bond is given for that Contract in compliance with Act No. 213 of the Michigan Public Acts of 1963, as amended, being MCL 129.201 et seq.
- (3) Whenever the Principal is declared by the City to be in default under the Contract, the Surety may promptly remedy the default or shall promptly:
- (a) complete the Contract in accordance with its terms and conditions; or
 - (b) obtain a bid or bids for submission to the City for completing the Contract in accordance with its terms and conditions, and upon determination by Surety of the lowest responsible bidder, arrange for a Contract between such bidder and the City, and make available, as work progresses, sufficient funds to pay the cost of completion less the balance of the Contract price; but not exceeding, including other costs and damages for which Surety may be liable hereunder, the amount set forth in paragraph 1.
- (4) Surety shall have no obligation to the City if the Principal fully and promptly performs under the Contract.
- (5) Surety agrees that no change, extension of time, alteration or addition to the terms of the Contract or to the work to be performed thereunder, or the specifications accompanying it shall in any way affect its obligations on this bond, and waives notice of any such change, extension of time, alteration or addition to the terms of the Contract or to the work, or to the specifications.
- (6) Principal, Surety, and the City agree that signatures on this bond may be delivered electronically in lieu of an original signature and agree to treat electronic signatures as original signatures that bind them to this bond. This bond may be executed and delivered by facsimile and upon such delivery, the facsimile signature will be deemed to have the same effect as if the original signature had been delivered to the other party.

SIGNED AND SEALED this _____ day of _____, 202_.

(Name of Surety Company)
By _____
(Signature)

Its _____
(Title of Office)

Approved as to form:

Atleen Kaur, City Attorney

(Name of Principal)
By _____
(Signature)

Its _____
(Title of Office)

Name and address of agent:

LABOR AND MATERIAL BOND

- (1) _____ of _____ (referred to as "Principal"), and _____, a corporation duly authorized to do business in the State of Michigan, (referred to as "Surety"), are bound to the City of Ann Arbor, Michigan (referred to as "City"), for the use and benefit of claimants as defined in Act 213 of Michigan Public Acts of 1963, as amended, being MCL 129.201 et seq., in the amount of \$ _____, for the payment of which Principal and Surety bind themselves, their heirs, executors, administrators, successors and assigns, jointly and severally, by this bond.
- (2) The Principal has entered a written Contract with the City entitled _____, for RFP No. _____; and this bond is given for that Contract in compliance with Act No. 213 of the Michigan Public Acts of 1963 as amended;
- (3) If the Principal fails to promptly and fully repay claimants for labor and material reasonably required under the Contract, the Surety shall pay those claimants.
- (4) Surety's obligations shall not exceed the amount stated in paragraph 1, and Surety shall have no obligation if the Principal promptly and fully pays the claimants.
- (5) Principal, Surety, and the City agree that signatures on this bond may be delivered electronically in lieu of an original signature and agree to treat electronic signatures as original signatures that bind them to this bond. This bond may be executed and delivered by facsimile and upon such delivery, the facsimile signature will be deemed to have the same effect as if the original signature had been delivered to the other party.

SIGNED AND SEALED this _____ day of _____, 202_

(Name of Surety Company)

By _____
(Signature)

Its _____
(Title of Office)

Approved as to form:

Atleen Kaur, City Attorney

(Name of Principal)

By _____
(Signature)

Its _____
(Title of Office)

Name and address of agent:

GENERAL CONDITIONS

Section 1 - Execution, Correlation and Intent of Documents

The contract documents shall be signed in 2 copies by the City and the Contractor.

The contract documents are complementary and what is called for by any one shall be binding. The intention of the documents is to include all labor and materials, equipment and transportation necessary for the proper execution of the work. Materials or work described in words which so applied have a well-known technical or trade meaning have the meaning of those recognized standards.

In case of a conflict among the contract documents listed below in any requirement(s), the requirement(s) of the document listed first shall prevail over any conflicting requirement(s) of a document listed later.

(1) Addenda in reverse chronological order; (2) Detailed Specifications; (3) Standard Specifications; (4) Plans; (5) General Conditions; (6) Contract; (7) Bid Forms; (8) Bond Forms; (9) Bid.

Section 2 - Order of Completion

The Contractor shall submit with each invoice, and at other times reasonably requested by the Supervising Professional, schedules showing the order in which the Contractor proposes to carry on the work. They shall include the dates at which the Contractor will start the several parts of the work, the estimated dates of completion of the several parts, and important milestones within the several parts.

Section 3 - Familiarity with Work

The Bidder or its representative shall make personal investigations of the site of the work and of existing structures and shall determine to its own satisfaction the conditions to be encountered, the nature of the ground, the difficulties involved, and all other factors affecting the work proposed under this Contract. The Bidder to whom this Contract is awarded will not be entitled to any additional compensation unless conditions are clearly different from those which could reasonably have been anticipated by a person making diligent and thorough investigation of the site.

The Bidder shall immediately notify the City upon discovery, and in every case prior to submitting its Bid, of every error or omission in the bidding documents that would be identified by a reasonably competent, diligent Bidder. In no case will a Bidder be allowed the benefit of extra compensation or time to complete the work under this Contract for extra expenses or time spent as a result of the error or omission.

Section 4 - Wage Requirements

Under this Contract, the Contractor shall conform to Chapter 14 of Title I of the Code of the City of Ann Arbor as amended; which in part states "...that all craftsmen, mechanics and laborers employed directly on the site in connection with said improvements, including said employees of

subcontractors, shall receive the prevailing wage for the corresponding classes of craftsmen, mechanics and laborers, as determined by statistics for the Ann Arbor area compiled by the United States Department of Labor. At the request of the City, any contractor or subcontractor shall provide satisfactory proof of compliance with the contract provisions required by the Section.

Pursuant to Resolution R-16-469 all public improvement contractors are subject to prevailing wage and will be required to provide to the City payroll records sufficient to demonstrate compliance with the prevailing wage requirements. A sample Prevailing Wage Form is provided in the Appendix herein for reference as to what will be expected from contractors. Use of the Prevailing Wage Form provided in the Appendix section or a City-approved equivalent will be required along with wage rate interviews.

Where the Contract and the Ann Arbor City Ordinance are silent as to definitions of terms required in determining contract compliance with regard to prevailing wages, the definitions provided in the Davis-Bacon Act as amended (40 U.S.C. 278-a to 276-a-7) for the terms shall be used.

If the Contractor is a "covered employer" as defined in Chapter 23 of the Ann Arbor City Code, the Contractor agrees to comply with the living wage provisions of Chapter 23 of the Ann Arbor City Code. The Contractor agrees to pay those employees providing Services to the City under this Contract a "living wage," as defined in Section 1:815 of the Ann Arbor City Code, as adjusted in accordance with Section 1:815(3); to post a notice approved by the City of the applicability of Chapter 23 in every location in which regular or contract employees providing services under this Contract are working; to maintain records of compliance; if requested by the City, to provide documentation to verify compliance; to take no action that would reduce the compensation, wages, fringe benefits, or leave available to any employee or person contracted for employment in order to pay the living wage required by Section 1:815; and otherwise to comply with the requirements of Chapter 23.

Contractor agrees that all subcontracts entered into by the Contractor shall contain similar wage provision covering subcontractor's employees who perform work on this contract.

Section 5 - Non-Discrimination

The Contractor agrees to comply, and to require its subcontractor(s) to comply, with the nondiscrimination provisions of MCL 37.2209. The Contractor further agrees to comply with the provisions of Section 9:158 of Chapter 112 of Title IX of the Ann Arbor City Code, and to assure that applicants are employed and that employees are treated during employment in a manner which provides equal employment opportunity.

Section 6 - Materials, Appliances, Employees

Unless otherwise stipulated, the Contractor shall provide and pay for all materials, labor, water, tools, equipment, light, power, transportation, and other facilities necessary or used for the execution and completion of the work. Unless otherwise specified, all materials incorporated in the permanent work shall be new, and both workmanship and materials shall be of the highest quality. The Contractor shall, if required, furnish satisfactory evidence as to the kind and quality of materials.

The Contractor shall at all times enforce strict discipline and good order among its employees, and shall seek to avoid employing on the work any unfit person or anyone not skilled in the work assigned.

Adequate sanitary facilities shall be provided by the Contractor.

Section 7 - Qualifications for Employment

The Contractor shall employ competent laborers and mechanics for the work under this Contract. For work performed under this Contract, employment preference shall be given to qualified local residents.

Section 8 - Royalties and Patents

The Contractor shall pay all royalties and license fees. It shall defend all suits or claims for infringements of any patent rights and shall hold the City harmless from loss on account of infringement except that the City shall be responsible for all infringement loss when a particular process or the product of a particular manufacturer or manufacturers is specified, unless the City has notified the Contractor prior to the signing of the Contract that the particular process or product is patented or is believed to be patented.

Section 9 - Permits and Regulations

The Contractor must secure and pay for all permits, permit or plan review fees and licenses necessary for the prosecution of the work. These include but are not limited to City building permits, right-of-way permits, lane closure permits, right-of-way occupancy permits, and the like. The City shall secure and pay for easements shown on the plans unless otherwise specified.

The Contractor shall give all notices and comply with all laws, ordinances, rules and regulations bearing on the conduct of the work as drawn and specified. If the Contractor observes that the contract documents are at variance with those requirements, it shall promptly notify the Supervising Professional in writing, and any necessary changes shall be adjusted as provided in the Contract for changes in the work.

Section 10 - Protection of the Public and of Work and Property

The Contractor is responsible for the means, methods, sequences, techniques and procedures of construction and safety programs associated with the work contemplated by this contract. The Contractor, its agents or sub-contractors, shall comply with the "General Rules and Regulations for the Construction Industry" as published by the Construction Safety Commission of the State of Michigan and to all other local, State and National laws, ordinances, rules and regulations pertaining to safety of persons and property.

The Contractor shall take all necessary and reasonable precautions to protect the safety of the public. It shall continuously maintain adequate protection of all work from damage, and shall take all necessary and reasonable precautions to adequately protect all public and private property from injury or loss arising in connection with this Contract. It shall make good any damage, injury or loss to its work and to public and private property resulting from lack of reasonable protective precautions, except as may be due to errors in the contract documents, or caused by agents or

employees of the City. The Contractor shall obtain and maintain sufficient insurance to cover damage to any City property at the site by any cause.

In an emergency affecting the safety of life, or the work, or of adjoining property, the Contractor is, without special instructions or authorization from the Supervising Professional, permitted to act at its discretion to prevent the threatened loss or injury. It shall also so act, without appeal, if authorized or instructed by the Supervising Professional.

Any compensation claimed by the Contractor for emergency work shall be determined by agreement or in accordance with the terms of Claims for Extra Cost - Section 15.

Section 11 - Inspection of Work

The City shall provide sufficient competent personnel for the inspection of the work.

The Supervising Professional shall at all times have access to the work whenever it is in preparation or progress, and the Contractor shall provide proper facilities for access and for inspection.

If the specifications, the Supervising Professional's instructions, laws, ordinances, or any public authority require any work to be specially tested or approved, the Contractor shall give the Supervising Professional timely notice of its readiness for inspection, and if the inspection is by an authority other than the Supervising Professional, of the date fixed for the inspection. Inspections by the Supervising Professional shall be made promptly, and where practicable at the source of supply. If any work should be covered up without approval or consent of the Supervising Professional, it must, if required by the Supervising Professional, be uncovered for examination and properly restored at the Contractor's expense.

Re-examination of any work may be ordered by the Supervising Professional, and, if so ordered, the work must be uncovered by the Contractor. If the work is found to be in accordance with the contract documents, the City shall pay the cost of re-examination and replacement. If the work is not in accordance with the contract documents, the Contractor shall pay the cost.

Section 12 - Superintendence

The Contractor shall keep on the work site, during its progress, a competent superintendent and any necessary assistants, all satisfactory to the Supervising Professional. The superintendent will be responsible to perform all on-site project management for the Contractor. The superintendent shall be experienced in the work required for this Contract. The superintendent shall represent the Contractor and all direction given to the superintendent shall be binding as if given to the Contractor. Important directions shall immediately be confirmed in writing to the Contractor. Other directions will be confirmed on written request. The Contractor shall give efficient superintendence to the work, using its best skill and attention.

Section 13 - Changes in the Work

The City may make changes to the quantities of work within the general scope of the Contract at any time by a written order and without notice to the sureties. If the changes add to or deduct from the extent of the work, the Contract Sum shall be adjusted accordingly. All the changes shall be

executed under the conditions of the original Contract except that any claim for extension of time caused by the change shall be adjusted at the time of ordering the change.

In giving instructions, the Supervising Professional shall have authority to make minor changes in the work not involving extra cost and not inconsistent with the purposes of the work, but otherwise, except in an emergency endangering life or property, no extra work or change shall be made unless in pursuance of a written order by the Supervising Professional, and no claim for an addition to the Contract Sum shall be valid unless the additional work was ordered in writing.

The Contractor shall proceed with the work as changed and the value of the work shall be determined as provided in Claims for Extra Cost - Section 15.

Section 14 - Extension of Time

Extension of time stipulated in the Contract for completion of the work will be made if and as the Supervising Professional may deem proper under any of the following circumstances:

- (1) When work under an extra work order is added to the work under this Contract;
- (2) When the work is suspended as provided in Section 20;
- (3) When the work of the Contractor is delayed on account of conditions which could not have been foreseen, or which were beyond the control of the Contractor, and which were not the result of its fault or negligence;
- (4) Delays in the progress of the work caused by any act or neglect of the City or of its employees or by other Contractors employed by the City;
- (5) Delay due to an act of Government;
- (6) Delay by the Supervising Professional in the furnishing of plans and necessary information;
- (7) Other cause which in the opinion of the Supervising Professional entitles the Contractor to an extension of time.

The Contractor shall notify the Supervising Professional within 7 days of an occurrence or conditions which, in the Contractor's opinion, entitle it to an extension of time. The notice shall be in writing and submitted in ample time to permit full investigation and evaluation of the Contractor's claim. The Supervising Professional shall acknowledge receipt of the Contractor's notice within 7 days of its receipt. Failure to timely provide the written notice shall constitute a waiver by the Contractor of any claim.

In situations where an extension of time in contract completion is appropriate under this or any other section of the contract, the Contractor understands and agrees that the only available adjustment for events that cause any delays in contract completion shall be extension of the required time for contract completion and that there shall be no adjustments in the money due the Contractor on account of the delay.

Section 15 - Claims for Extra Cost

If the Contractor claims that any instructions by drawings or other media issued after the date of the Contract involved extra cost under this Contract, it shall give the Supervising Professional written notice within 7 days after the receipt of the instructions, and in any event before proceeding to execute the work, except in emergency endangering life or property. The procedure shall then be as provided for Changes in the Work-Section I3. No claim shall be valid unless so made.

If the Supervising Professional orders, in writing, the performance of any work not covered by the contract documents, and for which no item of work is provided in the Contract, and for which no unit price or lump sum basis can be agreed upon, then the extra work shall be done on a Cost-Plus-Percentage basis of payment as follows:

- (1) The Contractor shall be reimbursed for all reasonable costs incurred in doing the work, and shall receive an additional payment of 15% of all the reasonable costs to cover both its indirect overhead costs and profit;
- (2) The term "Cost" shall cover all payroll charges for employees and supervision required under the specific order, together with all worker's compensation, Social Security, pension and retirement allowances and social insurance, or other regular payroll charges on same; the cost of all material and supplies required of either temporary or permanent character; rental of all power-driven equipment at agreed upon rates, together with cost of fuel and supply charges for the equipment; and any costs incurred by the Contractor as a direct result of executing the order, if approved by the Supervising Professional;
- (3) If the extra is performed under subcontract, the subcontractor shall be allowed to compute its charges as described above. The Contractor shall be permitted to add an additional charge of 5% percent to that of the subcontractor for the Contractor's supervision and contractual responsibility;
- (4) The quantities and items of work done each day shall be submitted to the Supervising Professional in a satisfactory form on the succeeding day, and shall be approved by the Supervising Professional and the Contractor or adjusted at once;
- (5) Payments of all charges for work under this Section in any one month shall be made along with normal progress payments. Retainage shall be in accordance with Progress Payments-Section 16.

No additional compensation will be provided for additional equipment, materials, personnel, overtime or special charges required to perform the work within the time requirements of the Contract.

When extra work is required and no suitable price for machinery and equipment can be determined in accordance with this Section, the hourly rate paid shall be 1/40 of the basic weekly rate listed in the Rental Rate Blue Book published by Dataquest Incorporated and applicable to the time period the equipment was first used for the extra work. The hourly rate will be deemed to include all costs of operation such as bucket or blade, fuel, maintenance, "regional factors", insurance, taxes, and the like, but not the costs of the operator.

Section 16 - Progress Payments

The Contractor shall submit each month, or at longer intervals, if it so desires, an invoice covering work performed for which it believes payment, under the Contract terms, is due. The submission shall be to the City's Finance Department - Accounting Division. The Supervising Professional will, within 10 days following submission of the invoice, prepare a certificate for payment for the work in an amount to be determined by the Supervising Professional as fairly representing the acceptable work performed during the period covered by the Contractor's invoice. To insure the proper performance of this Contract, the City will retain a percentage of the estimate in accordance with Act 524, Public Acts of 1980. The City will then, following the receipt of the Supervising Professional's Certificate, make payment to the Contractor as soon as feasible, which is anticipated will be within 15 days.

An allowance may be made in progress payments if substantial quantities of permanent material have been delivered to the site but not incorporated in the completed work if the Contractor, in the opinion of the Supervising Professional, is diligently pursuing the work under this Contract. Such materials shall be properly stored and adequately protected. Allowance in the estimate shall be at the invoice price value of the items. Notwithstanding any payment of any allowance, all risk of loss due to vandalism or any damages to the stored materials remains with the Contractor.

In the case of Contracts which include only the Furnishing and Delivering of Equipment, the payments shall be; 60% of the Contract Sum upon the delivery of all equipment to be furnished, or in the case of delivery of a usable portion of the equipment in advance of the total equipment delivery, 60% of the estimated value of the portion of the equipment may be paid upon its delivery in advance of the time of the remainder of the equipment to be furnished; 30% of the Contract Sum upon completion of erection of all equipment furnished, but not later than 60 days after the date of delivery of all of the equipment to be furnished; and payment of the final 10% on final completion of erection, testing and acceptance of all the equipment to be furnished; but not later than 180 days after the date of delivery of all of the equipment to be furnished, unless testing has been completed and shows the equipment to be unacceptable.

With each invoice for periodic payment, the Contractor shall enclose a Contractor's Declaration - Section 43, and an updated project schedule per Order of Completion - Section 2.

Section 17 - Deductions for Uncorrected Work

If the Supervising Professional decides it is inexpedient to correct work that has been damaged or that was not done in accordance with the Contract, an equitable deduction from the Contract price shall be made.

Section 18 - Correction of Work Before Final Payment

The Contractor shall promptly remove from the premises all materials condemned by the Supervising Professional as failing to meet Contract requirements, whether incorporated in the work or not, and the Contractor shall promptly replace and re-execute the work in accordance with the Contract and without expense to the City and shall bear the expense of making good all work of other contractors destroyed or damaged by the removal or replacement.

If the Contractor does not remove the condemned work and materials within 10 days after written notice, the City may remove them and, if the removed material has value, may store the material

at the expense of the Contractor. If the Contractor does not pay the expense of the removal within 10 days thereafter, the City may, upon 10 days written notice, sell the removed materials at auction or private sale and shall pay to the Contractor the net proceeds, after deducting all costs and expenses that should have been borne by the Contractor. If the removed material has no value, the Contractor must pay the City the expenses for disposal within 10 days of invoice for the disposal costs.

The inspection or lack of inspection of any material or work pertaining to this Contract shall not relieve the Contractor of its obligation to fulfill this Contract and defective work shall be made good. Unsuitable materials may be rejected by the Supervising Professional notwithstanding that the work and materials have been previously overlooked by the Supervising Professional and accepted or estimated for payment or paid for. If the work or any part shall be found defective at any time before the final acceptance of the whole work, the Contractor shall forthwith make good the defect in a manner satisfactory to the Supervising Professional. The judgment and the decision of the Supervising Professional as to whether the materials supplied and the work done under this Contract comply with the requirements of the Contract shall be conclusive and final.

Section 19 - Acceptance and Final Payment

Upon receipt of written notice that the work is ready for final inspection and acceptance, the Supervising Professional will promptly make the inspection. When the Supervising Professional finds the work acceptable under the Contract and the Contract fully performed, the Supervising Professional will promptly sign and issue a final certificate stating that the work required by this Contract has been completed and is accepted by the City under the terms and conditions of the Contract. The entire balance found to be due the Contractor, including the retained percentage, shall be paid to the Contractor by the City within 30 days after the date of the final certificate.

Before issuance of final certificates, the Contractor shall file with the City:

- (1) The consent of the surety to payment of the final estimate;
- (2) The Contractor's Affidavit in the form required by Section 44.

In case the Affidavit or consent is not furnished, the City may retain out of any amount due the Contractor, sums sufficient to cover all lienable claims.

The making and acceptance of the final payment shall constitute a waiver of all claims by the City except those arising from:

- (1) unsettled liens;
- (2) faulty work appearing within 12 months after final payment;
- (3) hidden defects in meeting the requirements of the plans and specifications;
- (4) manufacturer's guarantees.

It shall also constitute a waiver of all claims by the Contractor, except those previously made and still unsettled.

Section 20 - Suspension of Work

The City may at any time suspend the work, or any part by giving 5 days notice to the Contractor in writing. The work shall be resumed by the Contractor within 10 days after the date fixed in the

written notice from the City to the Contractor to do so. The City shall reimburse the Contractor for expense incurred by the Contractor in connection with the work under this Contract as a result of the suspension.

If the work, or any part, shall be stopped by the notice in writing, and if the City does not give notice in writing to the Contractor to resume work at a date within 90 days of the date fixed in the written notice to suspend, then the Contractor may abandon that portion of the work suspended and will be entitled to the estimates and payments for all work done on the portions abandoned, if any, plus 10% of the value of the work abandoned, to compensate for loss of overhead, plant expense, and anticipated profit.

Section 21 - Delays and the City's Right to Terminate Contract

If the Contractor refuses or fails to prosecute the work, or any separate part of it, with the diligence required to insure completion, ready for operation, within the allowable number of consecutive calendar days specified plus extensions, or fails to complete the work within the required time, the City may, by written notice to the Contractor, terminate its right to proceed with the work or any part of the work as to which there has been delay. After providing the notice the City may take over the work and prosecute it to completion, by contract or otherwise, and the Contractor and its sureties shall be liable to the City for any excess cost to the City. If the Contractor's right to proceed is terminated, the City may take possession of and utilize in completing the work, any materials, appliances and plant as may be on the site of the work and useful for completing the work. The right of the Contractor to proceed shall not be terminated or the Contractor charged with liquidated damages where an extension of time is granted under Extension of Time - Section 14.

If the Contractor is adjudged a bankrupt, or if it makes a general assignment for the benefit of creditors, or if a receiver is appointed on account of its insolvency, or if it persistently or repeatedly refuses or fails except in cases for which extension of time is provided, to supply enough properly skilled workers or proper materials, or if it fails to make prompt payments to subcontractors or for material or labor, or persistently disregards laws, ordinances or the instructions of the Supervising Professional, or otherwise is guilty of a substantial violation of any provision of the Contract, then the City, upon the certificate of the Supervising Professional that sufficient cause exists to justify such action, may, without prejudice to any other right or remedy and after giving the Contractor 3 days written notice, terminate this Contract. The City may then take possession of the premises and of all materials, tools and appliances thereon and without prejudice to any other remedy it may have, make good the deficiencies or finish the work by whatever method it may deem expedient, and deduct the cost from the payment due the Contractor. The Contractor shall not be entitled to receive any further payment until the work is finished. If the expense of finishing the work, including compensation for additional managerial and administrative services exceeds the unpaid balance of the Contract Sum, the Contractor and its surety are liable to the City for any excess cost incurred. The expense incurred by the City, and the damage incurred through the Contractor's default, shall be certified by the Supervising Professional.

Section 22 - Contractor's Right to Terminate Contract

If the work should be stopped under an order of any court, or other public authority, for a period of 3 months, through no act or fault of the Contractor or of anyone employed by it, then the Contractor may, upon 7 days written notice to the City, terminate this Contract and recover from the City payment for all acceptable work executed plus reasonable profit.

Section 23 - City's Right To Do Work

If the Contractor should neglect to prosecute the work properly or fail to perform any provision of this Contract, the City, 3 days after giving written notice to the Contractor and its surety may, without prejudice to any other remedy the City may have, make good the deficiencies and may deduct the cost from the payment due to the Contractor.

Section 24 - Removal of Equipment and Supplies

In case of termination of this Contract before completion, from any or no cause, the Contractor, if notified to do so by the City, shall promptly remove any part or all of its equipment and supplies from the property of the City, failing which the City shall have the right to remove the equipment and supplies at the expense of the Contractor.

The removed equipment and supplies may be stored by the City and, if all costs of removal and storage are not paid by the Contractor within 10 days of invoicing, the City upon 10 days written notice may sell the equipment and supplies at auction or private sale, and shall pay the Contractor the net proceeds after deducting all costs and expenses that should have been borne by the Contractor and after deducting all amounts claimed due by any lien holder of the equipment or supplies.

Section 25 - Responsibility for Work and Warranties

The Contractor assumes full responsibility for any and all materials and equipment used in the construction of the work and may not make claims against the City for damages to materials and equipment from any cause except negligence or willful act of the City. Until its final acceptance, the Contractor shall be responsible for damage to or destruction of the project (except for any part covered by Partial Completion and Acceptance - Section 26). The Contractor shall make good all work damaged or destroyed before acceptance. All risk of loss remains with the Contractor until final acceptance of the work (Section 19) or partial acceptance (Section 26). The Contractor is advised to investigate obtaining its own builders risk insurance.

The Contractor shall guarantee the quality of the work for a period of one year. The Contractor shall also unconditionally guarantee the quality of all equipment and materials that are furnished and installed under the contract for a period of one year. At the end of one year after the Contractor's receipt of final payment, the complete work, including equipment and materials furnished and installed under the contract, shall be inspected by the Contractor and the Supervising Professional. Any defects shall be corrected by the Contractor at its expense as soon as practicable but in all cases within 60 days. Any defects that are identified prior to the end of one year shall also be inspected by the Contractor and the Supervising Professional and shall be corrected by the Contractor at its expense as soon as practicable but in all cases within 60 days. The Contractor shall assign all manufacturer or material supplier warranties to the City prior to final payment. The assignment shall not relieve the Contractor of its obligations under this paragraph to correct defects.

Section 26 - Partial Completion and Acceptance

If at any time prior to the issuance of the final certificate referred to in Acceptance and Final Payment - Section 19, any portion of the permanent construction has been satisfactorily completed, and if the Supervising Professional determines that portion of the permanent construction is not required for the operations of the Contractor but is needed by the City, the Supervising Professional shall issue to the Contractor a certificate of partial completion, and immediately the City may take over and use the portion of the permanent construction described in the certificate, and exclude the Contractor from that portion.

The issuance of a certificate of partial completion shall not constitute an extension of the Contractor's time to complete the portion of the permanent construction to which it relates if the Contractor has failed to complete it in accordance with the terms of this Contract. The issuance of the certificate shall not release the Contractor or its sureties from any obligations under this Contract including bonds.

If prior use increases the cost of, or delays the work, the Contractor shall be entitled to extra compensation, or extension of time, or both, as the Supervising Professional may determine.

Section 27 - Payments Withheld Prior to Final Acceptance of Work

The City may withhold or, on account of subsequently discovered evidence, nullify the whole or part of any certificate to the extent reasonably appropriate to protect the City from loss on account of:

- (1) Defective work not remedied;
- (2) Claims filed or reasonable evidence indicating probable filing of claims by other parties against the Contractor;
- (3) Failure of the Contractor to make payments properly to subcontractors or for material or labor;
- (4) Damage to another Contractor.

When the above grounds are removed or the Contractor provides a Surety Bond satisfactory to the City which will protect the City in the amount withheld, payment shall be made for amounts withheld under this section.

Section 28 - Contractor's Insurance

- (1) The Contractor shall procure and maintain during the life of this Contract, including the guarantee period and during any warranty work, such insurance policies, including those set forth below, as will protect itself and the City from all claims for bodily injuries, death or property damage that may arise under this Contract; whether the act(s) or omission(s) giving rise to the claim were made by the Contractor, any subcontractor, or anyone employed by them directly or indirectly. Prior to commencement of any work under this contract, Contractor shall provide to the City documentation satisfactory to the City, through City-approved means (currently myCOI), demonstrating it has obtained the required policies and endorsements. The certificates of insurance endorsements and/or copies of

policy language shall document that the Contractor satisfies the following minimum requirements. Contractor shall add registration@mycoitracking.com to its safe sender's list so that it will receive necessary communication from myCOI. When requested, Contractor shall provide the same documentation for its subcontractor(s) (if any).

Required insurance policies include:

- (a) Worker's Compensation Insurance in accordance with all applicable state and federal statutes. Further, Employers Liability Coverage shall be obtained in the following minimum amounts:

- Bodily Injury by Accident - \$500,000 each accident
 - Bodily Injury by Disease - \$500,000 each employee
 - Bodily Injury by Disease - \$500,000 each policy limit

- (b) Commercial General Liability Insurance equivalent to, as a minimum, Insurance Services Office form CG 00 01 04 13 or current equivalent. The City of Ann Arbor shall be named as an additional insured. There shall be no added exclusions or limiting endorsements specifically for the following coverages: Products and Completed Operations, Explosion, Collapse and Underground coverage or Pollution. Further there shall be no added exclusions or limiting endorsements that diminish the City's protections as an additional insured under the policy. The following minimum limits of liability are required:

- \$1,000,000 Each occurrence as respect Bodily Injury Liability or Property Damage Liability, or both combined.
 - \$2,000,000 Per Project General Aggregate
 - \$1,000,000 Personal and Advertising Injury
 - \$2,000,000 Products and Completed Operations Aggregate, which, notwithstanding anything to the contrary herein, shall be maintained for three years from the date the Project is completed.

- (c) Motor Vehicle Liability Insurance, including Michigan No-Fault Coverages, equivalent to, as a minimum, Insurance Services Office form CA 00 01 10 13 or current equivalent. Coverage shall include all owned vehicles, all non-owned vehicles and all hired vehicles. The City of Ann Arbor shall be named as an additional insured. There shall be no added exclusions or limiting endorsements that diminish the City's protections as an additional insured under the policy. Further, the limits of liability shall be \$1,000,000 for each occurrence as respects Bodily Injury Liability or Property Damage Liability, or both combined.

- (d) Umbrella/Excess Liability Insurance shall be provided to apply excess of the Commercial General Liability, Employers Liability and the Motor Vehicle coverage enumerated above, for each occurrence and for aggregate in the amount of \$1,000,000.

- (2) Insurance required under subsection (1)(b) and (1)(c) above shall be considered primary as respects any other valid or collectible insurance that the City may possess, including any self-insured retentions the City may have; and any other insurance the City does possess shall be considered excess insurance only and shall not be required to contribute

with this insurance. Further, the Contractor agrees to waive any right of recovery by its insurer against the City for any insurance listed herein.

- (3) Insurance companies and policy forms are subject to approval of the City Attorney, which approval shall not be unreasonably withheld. Documentation must provide and demonstrate an unconditional and un-qualified 30-day written notice of cancellation in favor of the City of Ann Arbor. Further, the documentation must explicitly state the following: (a) the policy number(s); name of insurance company(s); name and address of the agent(s) or authorized representative(s); name(s), email address(es), and address of insured; project name; policy expiration date; and specific coverage amounts; (b) any deductibles or self-insured retentions which may be approved by the City, in its sole discretion; (c) that the policy conforms to the requirements specified Contractor shall furnish the City with satisfactory certificates of insurance and endorsements prior to commencement of any work. Upon request, the Contractor shall provide within 30 days a copy of the policy(ies) and all required endorsements to the City. If any of the above coverages expire by their terms during the term of this Contract, the Contractor shall deliver proof of renewal and/or new policies and endorsements to the Administering Service Area/Unit at least ten days prior to the expiration date.
- (4) Any Insurance provider of Contractor shall be authorized to do business in the State of Michigan and shall carry and maintain a minimum rating assigned by A.M. Best & Company's Key Rating Guide of "A-" Overall and a minimum Financial Size Category of "V". Insurance policies and certificates issued by non-authorized insurance companies are not acceptable unless approved in writing by the City.
- (5) City reserves the right to require additional coverage and/or coverage amounts as may be included from time to time in the Detailed Specifications for the Project.
- (6) The provisions of General Condition 28 shall survive the expiration or earlier termination of this contract for any reason.

Section 29 - Surety Bonds

Bonds will be required from the successful bidder as follows:

- (1) A Performance Bond to the City of Ann Arbor for the amount of the bid(s) accepted;
- (2) A Labor and Material Bond to the City of Ann Arbor for the amount of the bid(s) accepted.

Bonds shall be executed on forms supplied by the City in a manner and by a Surety Company authorized to transact business in Michigan and satisfactory to the City Attorney.

Section 30 - Damage Claims

The Contractor shall be held responsible for all damages to property of the City or others, caused by or resulting from the negligence of the Contractor, its employees, or agents during the progress of or connected with the prosecution of the work, whether within the limits of the work or elsewhere. The Contractor must restore all property injured including sidewalks, curbing, sodding, pipes, conduit, sewers or other public or private property to not less than its original condition with new work.

Section 31 - Refusal to Obey Instructions

If the Contractor refuses to obey the instructions of the Supervising Professional, the Supervising Professional shall withdraw inspection from the work, and no payments will be made for work performed thereafter nor may work be performed thereafter until the Supervising Professional shall have again authorized the work to proceed.

Section 32 - Assignment

Neither party to the Contract shall assign the Contract without the written consent of the other. The Contractor may assign any monies due to it to a third party acceptable to the City.

Section 33 - Rights of Various Interests

Whenever work being done by the City's forces or by other contractors is contiguous to work covered by this Contract, the respective rights of the various interests involved shall be established by the Supervising Professional, to secure the completion of the various portions of the work in general harmony.

The Contractor is responsible to coordinate all aspects of the work, including coordination of, and with, utility companies and other contractors whose work impacts this project.

Section 34 - Subcontracts

The Contractor shall not award any work to any subcontractor without prior written approval of the City. The approval will not be given until the Contractor submits to the City a written statement concerning the proposed award to the subcontractor. The statement shall contain all information the City may require.

The Contractor shall be as fully responsible to the City for the acts and omissions of its subcontractors, and of persons either directly or indirectly employed by them, as it is for the acts and omissions of persons directly employed by it.

The Contractor shall cause appropriate provisions to be inserted in all subcontracts relative to the work to bind subcontractors to the Contractor by the terms of the General Conditions and all other contract documents applicable to the work of the subcontractors and to give the Contractor the same power to terminate any subcontract that the City may exercise over the Contractor under any provision of the contract documents.

Nothing contained in the contract documents shall create any contractual relation between any subcontractor and the City.

Section 35 - Supervising Professional's Status

The Supervising Professional has the right to inspect any or all work. The Supervising Professional has authority to stop the work whenever stoppage may be appropriate to insure the proper execution of the Contract. The Supervising Professional has the authority to reject all work and materials which do not conform to the Contract and to decide questions which arise in the execution of the work.

The Supervising Professional shall make all measurements and determinations of quantities. Those measurements and determinations are final and conclusive between the parties.

Section 36 - Supervising Professional's Decisions

The Supervising Professional shall, within a reasonable time after their presentation to the Supervising Professional, make decisions in writing on all claims of the City or the Contractor and on all other matters relating to the execution and progress of the work or the interpretation of the contract documents.

Section 37 - Storing Materials and Supplies

Materials and supplies may be stored at the site of the work at locations agreeable to the City unless specific exception is listed elsewhere in these documents. Ample way for foot traffic and drainage must be provided, and gutters must, at all times, be kept free from obstruction. Traffic on streets shall be interfered with as little as possible. The Contractor may not enter or occupy with agents, employees, tools, or material any private property without first obtaining written permission from its owner. A copy of the permission shall be furnished to the Supervising Professional.

Section 38 - Lands for Work

The Contractor shall provide, at its own expense and without liability to the City, any additional land and access that may be required for temporary construction facilities or for storage of materials.

Section 39 - Cleaning Up

The Contractor shall, as directed by the Supervising Professional, remove at its own expense from the City's property and from all public and private property all temporary structures, rubbish and waste materials resulting from its operations unless otherwise specifically approved, in writing, by the Supervising Professional.

Section 40 - Salvage

The Supervising Professional may designate for salvage any materials from existing structures or underground services. Materials so designated remain City property and shall be transported or stored at a location as the Supervising Professional may direct.

Section 41 - Night, Saturday or Sunday Work

No night or Sunday work (without prior written City approval) will be permitted except in the case of an emergency and then only to the extent absolutely necessary. The City may allow night work which, in the opinion of the Supervising Professional, can be satisfactorily performed at night. Night work is any work between 8:00 p.m. and 7:00 a.m. No Saturday work will be permitted unless the Contractor gives the Supervising Professional at least 48 hours but not more than 5 days notice of the Contractor's intention to work the upcoming Saturday.

Section 42 - Sales Taxes

Under State law the City is exempt from the assessment of State Sales Tax on its direct purchases. Contractors who acquire materials, equipment, supplies, etc. for incorporation in City projects are not likewise exempt. State Law shall prevail. The Bidder shall familiarize itself with the State Law and prepare its Bid accordingly. No extra payment will be allowed under this Contract for failure of the Contractor to make proper allowance in this bid for taxes it must pay.

Section 43

CONTRACTOR'S DECLARATION

I hereby declare that I have not, during the period _____, 20____, to _____, 20____, performed any work, furnished any materials, sustained any loss, damage or delay, or otherwise done anything in addition to the regular items (or executed change orders) set forth in the Contract titled _____, for which I shall ask, demand, sue for, or claim compensation or extension of time from the City, except as I hereby make claim for additional compensation or extension of time as set forth on the attached itemized statement. I further declare that I have paid all payroll obligations related to this Contract that have become due during the above period and that all invoices related to this Contract received more than 30 days prior to this declaration have been paid in full except as listed below.

There is/is not (Contractor please circle one and strike one as appropriate) an itemized statement attached regarding a request for additional compensation or extension of time.

Contractor

Date

By _____
(Signature)

Its _____
(Title of Office)

Past due invoices, if any, are listed below.

STANDARD SPECIFICATIONS

All work performed under this Contract shall be performed in accordance with the 2024 Public Services Standard Specifications. All work under this Contract which is not included in these Standard Specifications, or which is performed using modifications to these Standard Specifications, shall be performed in accordance with the Detailed Specifications included in these contract documents.

Copies of the Standard Specifications can be downloaded from the following web link.

<https://www.a2gov.org/departments/engineering/Pages/Engineering-and-Contractor-Resources.aspx>

DETAILED SPECIFICATIONS

Project Schedule.....	DS-2
01040.70 Traffic Control, Max \$7,500.....	DS-4
03002.70 Sidewalk Grading.....	DS-7
08110.70 Concrete Curb or Curb & Gutter, All Types.....	DS-8
08111.70 Concrete Curb or Curb & Gutter, All Types, High Early	DS-8
08130.71 4-Inch Concrete Sidewalk	DS-9
08131.71 6-Inch Concrete Sidewalk, Driveway, Ramp.....	DS-9
08132.71 6-Inch Concrete Sidewalk, Driveway, Ramp – High Early	DS-9
08133.71 8-inch Conc. Sidewalk, Driveway, Ramp, Fibermesh - High Early.....	DS-9
08135.71 Integral Sidewalk Retaining Wall (7" or Less)	DS-11
08135.72 Integral Sidewalk Retaining Wall (7" - 18")	DS-11
08135.73 Integral Sidewalk Retaining Wall (19" - 36")	DS-11
08301.70 Adjust Monument, Valve, or Curb Box.....	DS-15
08302.70 Adjust Handhole	DS-15
08303.70 Adjust Storm Structure Cover	DS-15
08304.70 Adjust Storm Inlet Cover.....	DS-15
09055.70 Pedestrian Signal Pole Foundation.....	DS-16
10060.70 Turf Restoration	DS-18

**DETAILED SPECIFICATION
FOR
PROJECT SCHEDULE
[1]**

The Contractor shall begin work on this Project within one week of the receipt of the Notice to Proceed. In no case shall any work begin prior to receipt of formal notice of award by the City of Ann Arbor. The estimated start date of construction activities is **April 15, 2024**.

The project work is divided into four Concrete Sidewalk Areas as detailed in Appendix A of the contract documents, and therefore project milestone completion dates are required. Each area's list of repair locations will be available no later than 7 days prior to the Contractor's anticipated beginning of the area, the first area list being available by April 8, 2024.

Milestone Completion Dates

The contract requires intermediate milestone completion dates detailed as follows:

June 1, 2024 – One Sidewalk Repair area and approximately 25% of the new ramps, foundations, and miscellaneous repairs shall be complete and inspected by the Engineer.

July 27, 2024 – Two Sidewalk Repair areas and approximately 50% of the new ramps, foundations, and miscellaneous repairs shall be complete and inspected by the Engineer. Punch list from the previous milestone shall be approved by the Engineer.

September 14, 2024 – Three Sidewalk Repair areas and approximately 75% of the new ramps, foundations, and miscellaneous repairs shall be complete and inspected by the Engineer. Punch list from the previous milestone shall be approved by the Engineer.

November 1, 2024 – Four Sidewalk Repair areas and approximately 100% of the new ramps, foundations, and miscellaneous repairs shall be complete and inspected by the Engineer. Punch list from previous milestone shall be approved by the Engineer.

The entire work of this Contract including all final asphalt patching, final clean-up and the completion of all restoration, and any other related project work shall be completed on, or before, **November 15, 2024**.

Liquidated Damages

This project is on an expedited schedule, and is subject to Liquidated Damages.

Time is of the essence in the performance of the work of this contract. The Contractor is expected to mobilize sufficient personnel and equipment, and work the required overtime to complete the project by the dates specified herein. Once construction has commenced, the Contractor shall work continuously on the project until it is satisfactorily completed and approved in writing by the Engineer. The Contractor shall not suspend work on this

**DETAILED SPECIFICATION
FOR
PROJECT SCHEDULE
[2]**

project unless authorized in writing by the Engineer or stipulated elsewhere in the contract documents.

Failure to complete work by the above described milestone and final completion dates shall entitle the City to deduct from the payments due to the Contractor, \$500.00 in Liquidated Damages, and not as a penalty, for each and every calendar day beyond the completion date of the specified work, or time extension(s) granted thereto, as required by this Detailed Specification.

All liquidated damages amounts are additive and may be charged concurrently. Should the Engineer approve a request for an extension of contract time and/or revise any intermediate or final completion date, liquidated damages will be based on the revised dates for which the time extensions specifically apply. Liquidated Damages will be charged for incomplete work during periods of seasonal suspensions.

Schedule Restrictions

During these times, the Contractor must remove all equipment from the vicinities and have all sidewalks and ramps fully completed and open to traffic. These restrictions and requirements are deemed to be included in the required Milestone Completion Dates contained within the contract.

- **Ann Arbor Art Fair:** No work shall be done in areas in close proximity to, or along major routes to or from, the annual Ann Arbor Art Fair from Wednesday, July 17 through Sunday, July 21, 2024 for the Art Fair activities.
- **University of Michigan home football games:** No work shall be done in areas in close proximity to, or along major routes to or from, the University of Michigan Stadium on the Friday and Saturday of all home football games. The game schedule can be found at <https://mgoblue.com/sports/football/schedule/2024>.

The Public Services Standard Specifications (2024) and Detailed Specifications herein shall govern the performance and execution of all construction operations.

Costs for the Contractor to organize, coordinate, and schedule all of the work of the project, will not be paid for separately, but shall be considered to be included in the bid price of the Contract Item **“General Conditions.”**

**DETAILED SPECIFICATION
FOR
ITEM #01040.70 TRAFFIC CONTROL
[1]**

DESCRIPTION

This work shall consist of all labor, equipment, and material to provide traffic maintenance and control in accordance with the Public Services Standard Specifications (2024), with the following modifications and details contained herein.

MEASUREMENT AND PAYMENT

In addition to the requirements indicated in Article 11, GG., payment for Minor Traffic Control shall include all labor, equipment and materials to install City-provided “No Parking” signs as needed for proper access to construction work sites, as well as the removal and return of the “No Parking signs” to the City upon completion of the project.

Payment for Traffic Control shall include all labor, equipment and materials to provide Traffic Regulator Control as directed by the Engineer when needed.

Payment for Traffic Control will be paid on a pro-rata basis at the time of each progress payment. Measurement will be based on the ratio between work completed during the payment period and the total contract amount. When all of the work for this Contract has been completed, the measurement of this item shall be 1.0 Lump Sum.

**DETAILED SPECIFICATION
FOR
ITEM #01040.70 TRAFFIC CONTROL
[2]**

Figure 6H-28. Sidewalk Detour or Diversion (TA-28)

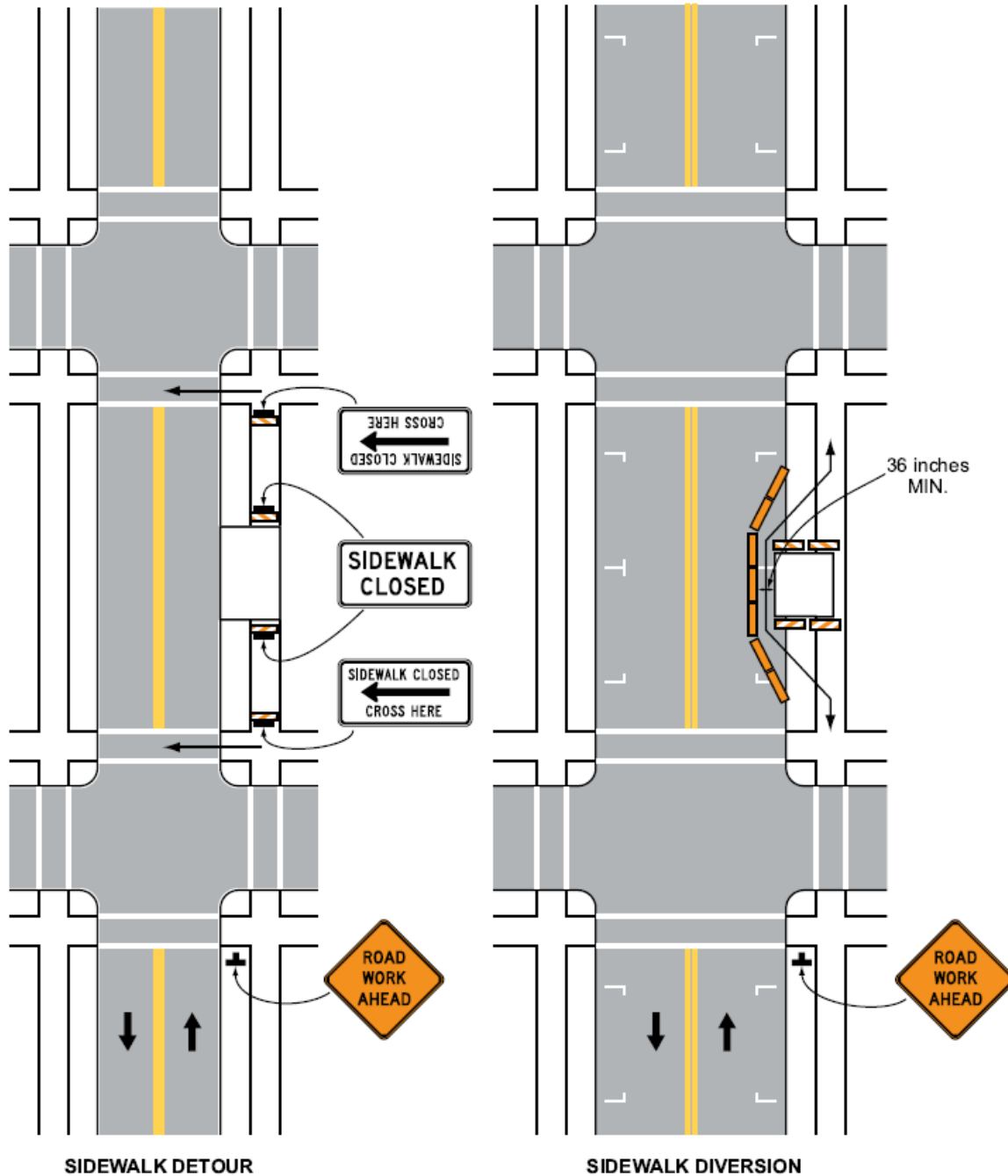

Typical Application 28

Note: See Tables 6H-2 and 6H-3 for the meaning of the symbols and/or letter codes used in this figure.
Page 689(MI) 2009 Edition

**DETAILED SPECIFICATION
FOR
ITEM #01040.70 TRAFFIC CONTROL
[3]**

Figure 6H-29. Crosswalk Closures and Pedestrian Detours (TA-29)

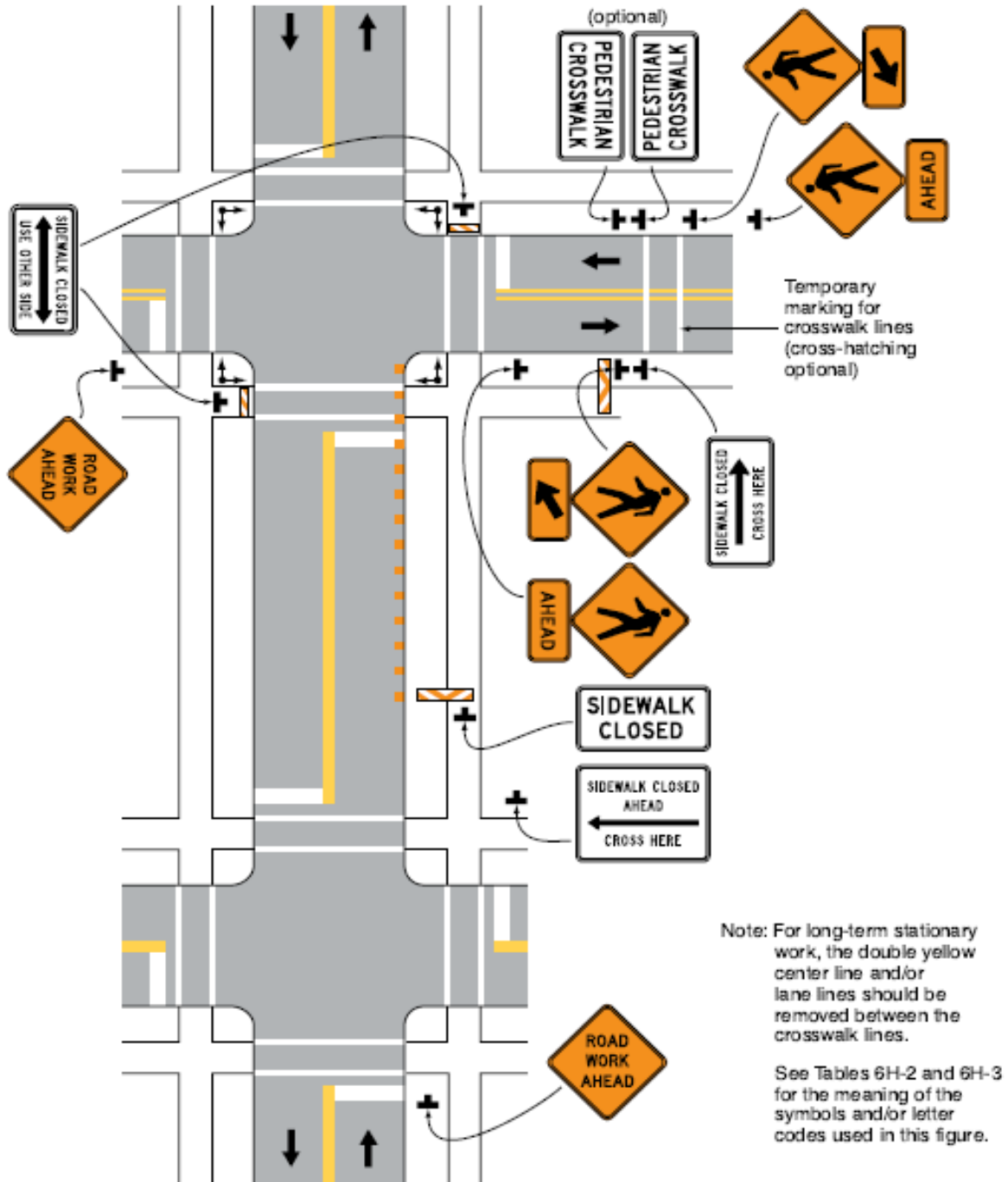

Typical Application 29

**DETAILED SPECIFICATION
FOR
ITEM #03002.70 SIDEWALK GRADING
[1]**

DESCRIPTION

Complete earthwork required to construct proposed sidewalk cross sections for ADA-compliant sidewalk and ramp, including key flags, curb ramps, and retaining walls as needed, where new sidewalk and ramps are being proposed. Complete this work according to the Public Services Standard Specifications (2024), including Article 10, Section III.G.2.

CONSTRUCTION

Access to driveways and entrances may be permitted to be temporarily interrupted, provided the Contractor provides adequate advanced notification to the property owners/tenants, and schedules the work to minimize the duration of the interruption.

MEASUREMENT AND PAYMENT

The completed work, as described, will be measured as the area of subbase required for the new sidewalk and ramps, and paid for at the contract unit price using the following pay item:

Pay Item	Pay Unit
Sidewalk Grading	Square Yards

Sidewalk Grading includes all labor, equipment and materials necessary to complete the work as described and will be measured in square yards for the area as necessary in the field to construct the Work.

Removal of pavement, curb, sidewalk, driveway, and ramps; Subgrade Undercut; Utility Adjustment; and Subbase, Sidewalk, Retaining Wall installation shall be paid separately. Turf restoration not otherwise incidental to Sidewalk, Curb & Gutter, and Retaining Wall installation shall be paid separately.

**DETAILED SPECIFICATION
FOR
ITEM #08110.70 CONCRETE CURB & GUTTER, ALL TYPES
ITEM #08111.70 CONCRETE CURB & GUTTER, ALL TYPES –
HIGH EARLY
[1]**

DESCRIPTION

This work shall consist of constructing concrete items including all types of curb & gutter, of regular or high early concrete, in accordance with Public Services Standard Specifications (2024) Articles 5, 6, 10, and 11, and as specified herein.

CONSTRUCTION

A minimum 3-day cure of the “High Early” concrete curb and gutter shall be required before paving of adjacent bituminous pavement and/or being opened to vehicular traffic.

The Contractor shall restore all disturbed areas as described in Article 10, Section VI. B. (Turf Establishment) within two calendar days from the date of concrete placement. Restoration work associated with the items of work described in this Detailed Specification shall be incidental to the cost of the items within 12 inches of the edge of sidewalk.

MEASUREMENT AND PAYMENT

PAY ITEMS

PAY UNIT

Conc, Curb or Curb & Gutter, All Types	Linear Foot
Conc, Curb or Curb & Gutter, All Types, High Early	Linear Foot

The unit prices for these items of work shall include all labor, material, and equipment costs to perform all the work specified in the Standard Specifications and as modified by this Detailed Specification.

**DETAILED SPECIFICATION
FOR
ITEM #08130.71 4-INCH CONCRETE
ITEM #08131.71 6-INCH CONCRETE
ITEM #08132.71 6-INCH CONCRETE – HIGH EARLY
ITEM #08133.71 8-INCH FIBERMESH-REINF. CONCRETE –
HIGH EARLY**

[1]

DESCRIPTION

This work shall consist of constructing concrete items including sidewalks, drive approaches or ramps, of regular or high early concrete, with or without fibermesh reinforcement, in accordance with Public Services Standard Specifications (2024) Articles 6, 10, and 11, and as specified herein.

MATERIALS

Minimum requirements for driveway approaches shall be MDOT Grade P-NC concrete, unless otherwise directed, in conformance with MDOT Specifications, Section 1006 (Patching, Repair, and Overlay Mixtures).

Minimum requirements for driveway approaches for uses other than single- or two-family residences shall be 8-inch thick fibermesh-reinforced MDOT Grade P-NC concrete in conformance with MDOT Specifications, Section 1006 (Patching, Repair, and Overlay Mixtures).

“Fibermesh Reinforced” concrete shall have polypropylene fibrillated fibers added at the rate of 1.5 pounds per cubic yard. The fibers shall meet the requirements of ASTM C1116 Classification Type III, synthetic fiber-reinforced concrete. The concrete shall be thoroughly mixed for a minimum of 5 minutes after the addition of the fibers to assure uniform distribution throughout the concrete.

CONSTRUCTION

The “High Early” concrete items being placed shall be opened to vehicular traffic 72-hours after placement.

The Contractor shall restore all disturbed areas as described in Article 10, Section VI. B. (Turf Establishment) within two calendar days from the date of concrete placement. Restoration work associated with the items of work described in this Detailed Specification shall be incidental to the cost of the items within 12 inches of the edge of sidewalk.

DETAILED SPECIFICATION
FOR
ITEM #08130.71 4-INCH CONCRETE
ITEM #08131.71 6-INCH CONCRETE
ITEM #08132.71 6-INCH CONCRETE – HIGH EARLY
ITEM #08133.71 8-INCH FIBERMESH-REINF. CONCRETE –
HIGH EARLY
 [2]

MEASUREMENT AND PAYMENT

PAY ITEMS

PAY UNIT

Conc, Sidewalk, 4 In.	Square Foot
Conc, Sidewalk, Drive Approach, or Ramp, 6 in.	Square Foot
Conc, Sidewalk, Drive Approach, or Ramp, 6 in., High Early	Square Foot
Conc, Fibermesh Reinf., Sidewalk, Drive Approach, or Ramp, 8 In., High Early	Square Foot

The unit prices for these items of work shall include all labor, material, and equipment costs to perform all the work specified in the Standard Specifications and as modified by this Detailed Specification.

**DETAILED SPECIFICATION
FOR
ITEM #08135.71 CONCRETE INTEGRAL RETAINING WALL (7" OR LESS)
ITEM #08135.72 CONCRETE INTEGRAL RETAINING WALL (7"-18")
ITEM #08135.73 CONCRETE INTEGRAL RETAINING WALL (19"-36")**

[1]

DESCRIPTION

This work shall consist of constructing retaining walls adjacent to sidewalks, in accordance with Sections 802 and 803 of MDOT Standard Specifications for Construction, the Public Services Standard Specifications (2024), and as specified herein.

MATERIALS

Concrete mixtures shall be MDOT Grade 3500 concrete, in conformance with MDOT Specifications, Section 1004 (Portland Cement Concrete Mixtures).

Reinforcing steel shall conform to MDOT Specifications, Section 905 (Steel Reinforcement).

Aggregate shall be in accordance with Public Services Standard Specifications (2024) Article 5.

CONSTRUCTION

The Contractor shall construct the Integral Retaining Walls as shown in the details herein. Construction shall be in accordance with Sections 802 and 803 of MDOT Standard Specifications.

The Contractor shall restore all disturbed areas as described in Article 10, Section VI. B. (Turf Establishment) within three calendar days from the date of concrete placement. Restoration work associated with the items of work described in this Detailed Specification shall be incidental to the cost of the items within 12 inches of the back of retaining wall.

MEASUREMENT AND PAYMENT

The completed work as measured by the exposed face area of the retaining wall.

PAY ITEMS

PAY UNIT

Concrete Integral Retaining Wall (7" or Less)	Square Foot
Concrete Integral Retaining Wall (7" – 18")	Square Foot
Concrete Integral Retaining Wall (19" – 36")	Square Foot

The unit prices for these items of work shall include all labor, material, and equipment costs to perform all the work specified as modified by this Detailed Specification, including, but not limited to, drainage aggregate, filter fabric, and jointing.

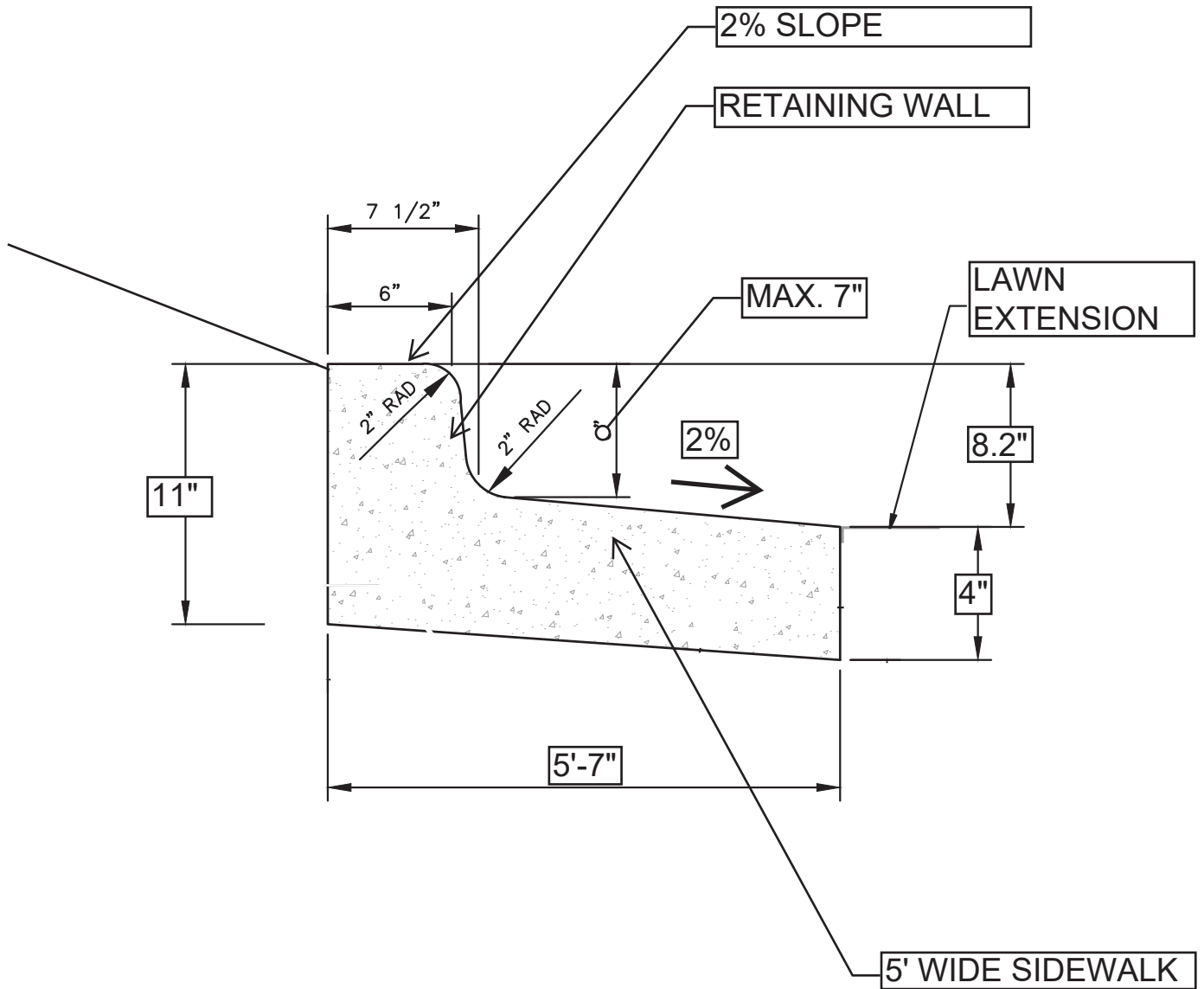

**CITY OF ANN ARBOR
PUBLIC SERVICES**
301 EAST HURON STREET
P.O. BOX 8647
ANN ARBOR, MI 48107-8647
734-794-6410
www.a2gov.org

REV. NO.	DATE	DRAWN BY	CHECKED BY
INTEGRAL SIDEWALK RETAINING (7" OR LESS)			
DR. ENG	CH. ENG	DRAWING NO.	
SCALE N.T.S.	DATE 1/23/2024	SW-RW-1	

DS-12

INTEGRAL SIDEWALK RETAINING WALL (7" – 18") DETAIL

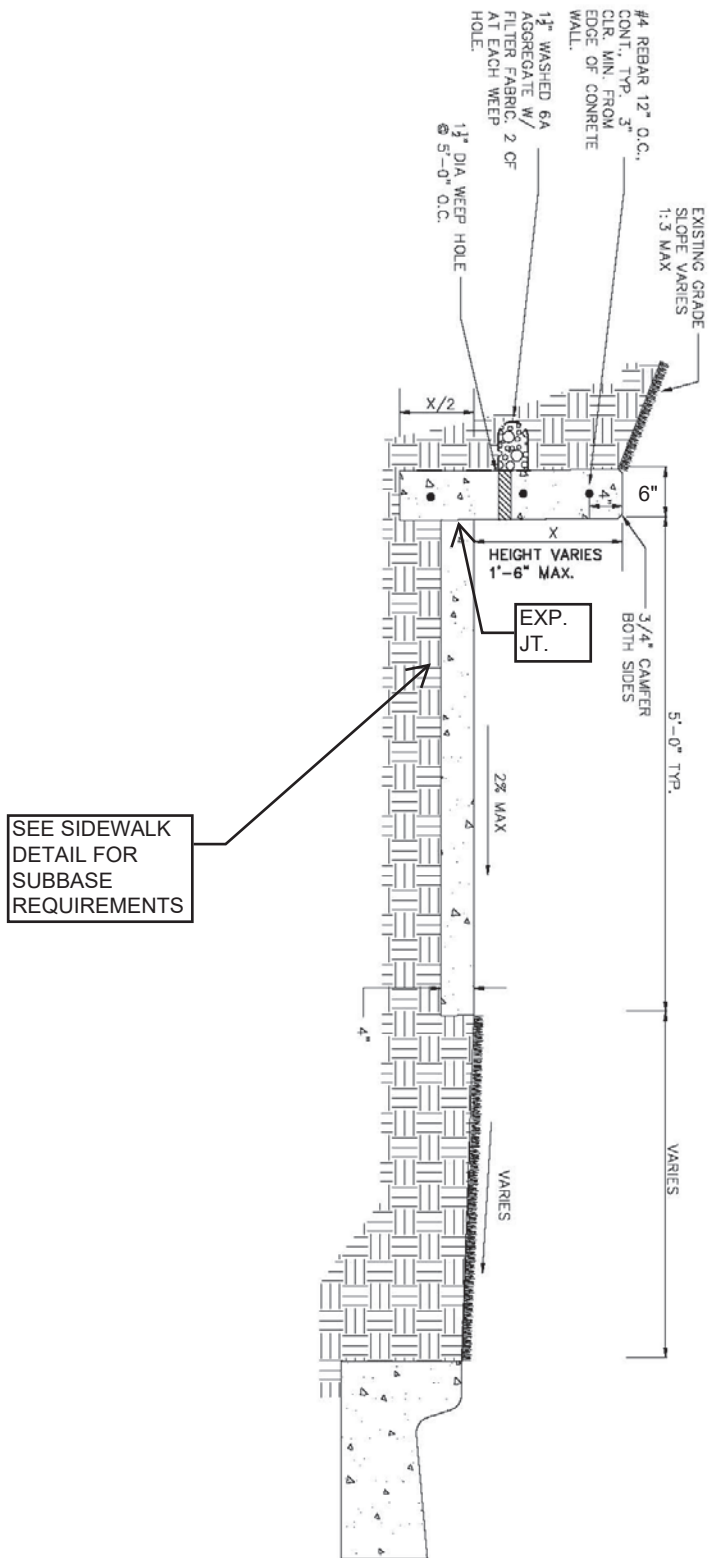

INTEGRAL SIDEWALK RETAINING WALL (18"-36") DETAIL

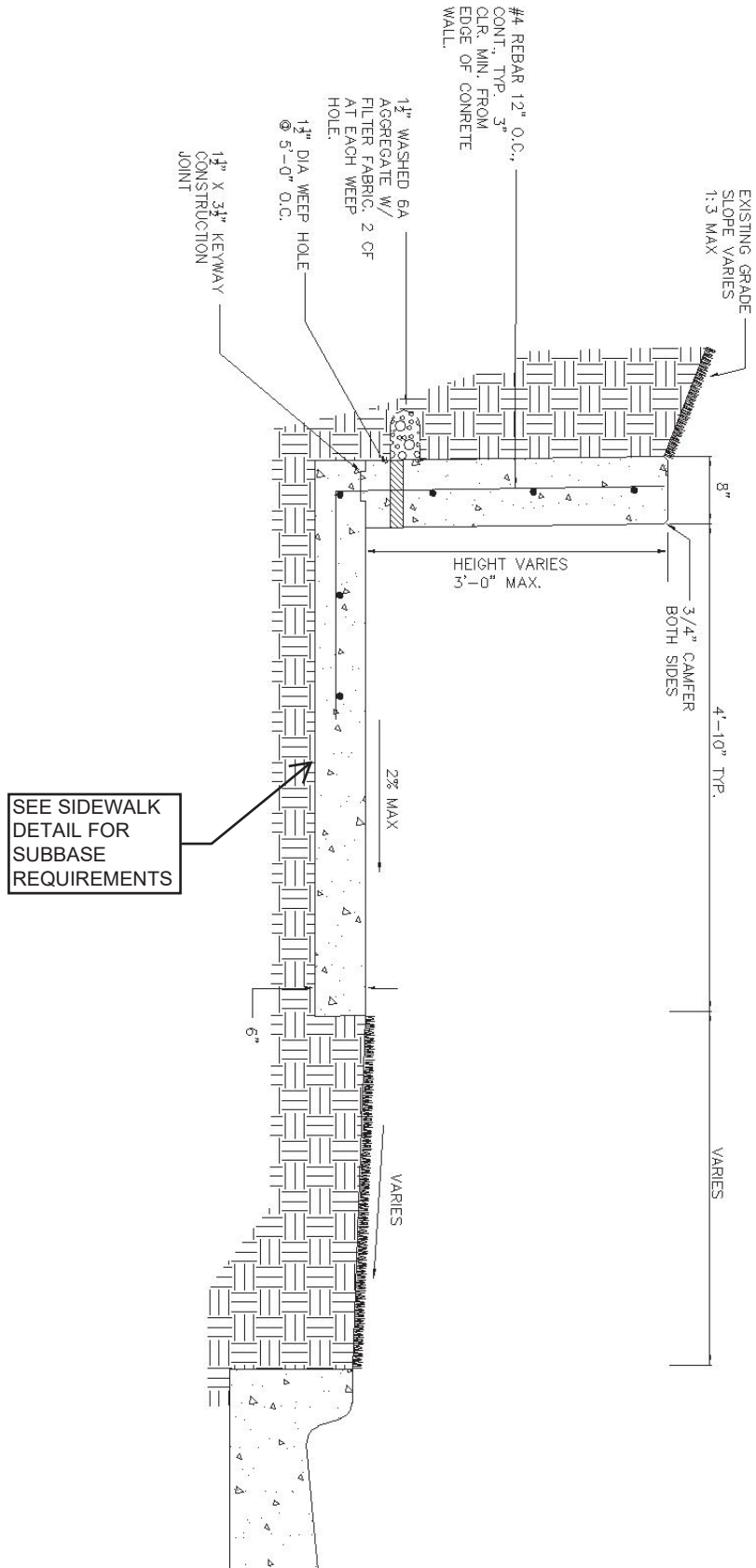

DETAILED SPECIFICATION

FOR

- ITEM #08301.70 ADJUST MONUMENT, VALVE, OR CURB BOX**
- ITEM #08302.70 ADJUST HANDHOLE**
- ITEM #08303.70 ADJUST STORM STRUCTURE COVER**
- ITEM #08304.70 ADJUST STORM INLET COVER**

[1]

DESCRIPTION

This work shall consist of adjusting curb or valve boxes, monument boxes, and handholes, and adjusting and pointing structure covers; including all excavation, backfilling, patching and the removal and proper disposal off-site of all excavated material and debris, all in accordance with Articles 10, 11, and 12 in the Public Services Standard Specifications (2024), except as specified herein, and except as directed by the Engineer.

CONSTRUCTION

Hidden or buried utility structures may be encountered during the work. It is the responsibility of to inform the respective utility owner(s) of such findings. In such instances the City may direct the Contractor to adjust the structure(s) to grade. This work will be paid as "Adjust Storm Structure Cover".

The pointing of structures is included in all adjustments.

Adjust Handhole includes the final adjustment of existing traffic signal handholes up or down, to a finished elevation flush with the pavement elevation.

Adjust Monument, Valve or Curb Box includes the replacement of the top half of the water boxes or monument boxes (furnished by the City) where required, and shall be included in this item of work. The Contractor shall transport these new castings and covers to the site from the City Utilities Department yard at 4251 Stone School Road (Wheeler Center).

MEASUREMENT AND PAYMENT

PAY ITEMS

PAY UNIT

Monument, Valve, Curb Box, Adjust	Each
Handhole, Adjust	Each
Storm Structure Cover, Adjust	Each
Storm Inlet Cover, Adjust	Each

The unit prices for these items of work shall include all labor, material, and equipment costs to perform all the work specified as modified by this Detailed Specification.

**DETAILED SPECIFICATION
FOR
ITEM #09055.70 – PEDESTRIAN SIGNAL POLE FOUNDATION
[1]**

DESCRIPTION

This work shall consist of all labor, equipment, and material to install concrete foundations at locations directed by the Engineer. All work shall be completed in accordance with the Public Services Standard Specifications (2024), the detail contained herein, and with the following modifications.

MATERIAL

Concrete mixtures shall be MDOT Grade 4000 concrete, in conformance with Section 1004 of the 2020 edition of the MDOT Standard Specifications. The City will provide the sonotube and anchor bolt template, conduits, their fittings, and the bolt assemblies.

CONSTRUCTION

At locations where the subgrade becomes either disturbed, saturated or otherwise damaged, and where directed by the Engineer, the Contractor shall remove a minimum 6-inch thick layer of the subgrade, and replace it with approved 21AA crushed limestone aggregate material, compacted in place, to be paid separately as Subgrade Undercut, Type III.

MEASUREMENT AND PAYMENT

The completed work of Concrete Foundations will be paid for at the contract unit price for the following contract items (pay items):

<u>PAY ITEM</u>	<u>PAY UNIT</u>
Foundation, Pedestrian Signal Pole	Each

The unit prices for this item of work shall include all labor, materials and equipment costs necessary for installing pedestrian pole foundations, as detailed in the Specifications and as required by the Public Services Standard Specifications (2024). The pay item shall also include excavation and proper offsite disposal of materials, and providing turf restoration of any disturbed areas.

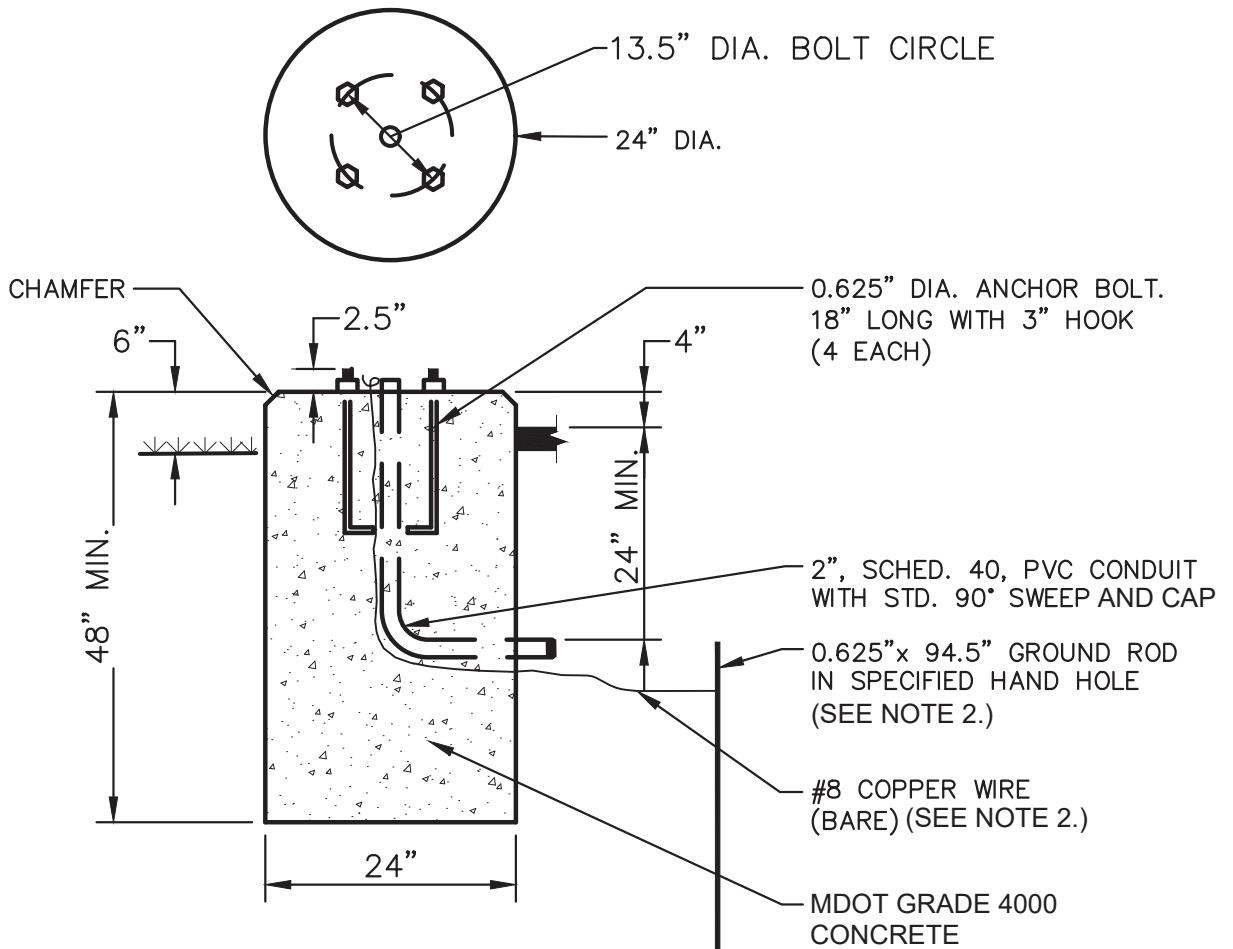

NOTES:

1. THE CITY WILL INSPECT THE AUGERED HOLE AND ANCHOR BOLT BUILD-UP, AND PROVIDE WRITTEN APPROVAL PRIOR TO THE PLACEMENT OF CONCRETE.
2. GROUNDING NOT REQUIRED FOR SOLAR-POWERED R.R.F.B.



**CITY OF ANN ARBOR
PUBLIC SERVICES**
301 EAST HURON STREET
P.O. BOX 8647
ANN ARBOR, MI 48107-8647
734-794-6410
www.a2gov.org

1	1/19/24	TCB	MM
REV. NO.	DATE	DRAWN BY	CHECKED BY
PEDESTRIAN SIGNAL POLE FOUNDATION			
DR. ENG	CH. ENG	DRAWING NO.	
SCALE N.T.S.	DATE 12/8/2023	SD-SL-3	

DS-17

**DETAILED SPECIFICATION
FOR
ITEM #10060.70 – TURF RESTORATION
[1]**

DESCRIPTION

This work shall consist of all labor, equipment, and material to install turf restoration that is not otherwise incidental to concrete pay items. All work shall be completed in accordance with Articles 9, 10, and 11 of the Public Services Standard Specifications (2024), with the following modifications.

MEASUREMENT AND PAYMENT

The completed work of Turf Restoration will be measured excluding the 12 inches adjacent to concrete items, as indicated in the respective Detailed Specifications, and paid for at the contract unit price for the following contract items (pay items):

PAY ITEM

Turf Restoration

PAY UNIT

Square Yard

Payment includes all labor, material and equipment costs required to furnish and install PSAA-approved topsoil, approved seed mixtures, fertilizer and mulch, including grading of the area to receive the topsoil, preparing the earth bed, spreading and raking the topsoil to provide a uniform surface free of large clods, lumps, rocks, brush, roots, or other deleterious materials, as determined by the PSAA.

ATTACHMENT B
GENERAL DECLARATIONS

City of Ann Arbor
Guy C. Larcom Municipal Building
Ann Arbor, Michigan 48107

Ladies and Gentlemen:

The undersigned, as Bidder, declares that this Bid is made in good faith, without fraud or collusion with any person or persons bidding on the same Contract; that this Bidder has carefully read and examined the bid documents, including City Nondiscrimination requirements and Declaration of Compliance Form, Living Wage requirements and Declaration of Compliance Form, Prevailing Wage requirements and Declaration of Compliance Form, Vendor Conflict of Interest Form, Notice of Pre-Bid Conference, General Information, Bid, Bid Forms, Contract, Bond Forms, General Conditions, Standard Specifications, Detailed Specifications, all Addenda, and the Plans (if applicable) and understands them. The Bidder declares that it conducted a full investigation at the site and of the work proposed and is fully informed as to the nature of the work and the conditions relating to the work's performance. The Bidder also declares that it has extensive experience in successfully completing projects similar to this one.

The Bidder acknowledges that it has not received or relied upon any representations or warranties of any nature whatsoever from the City of Ann Arbor, its agents or employees, and that this Bid is based solely upon the Bidder's own independent business judgment.

The undersigned proposes to perform all work shown on the plans or described in the bid documents, including any addenda issued, and to furnish all necessary machinery, tools, apparatus, and other means of construction to do all the work, furnish all the materials, and complete the work in strict accordance with all terms of the Contract of which this Bid is one part.

In accordance with these bid documents, and Addenda numbered 1, the undersigned, as Bidder, proposes to perform at the sites in and/or around Ann Arbor, Michigan, all the work included herein for the amounts set forth in the Bid Forms.

The Bidder declares that it has become fully familiar with the liquidated damage clauses for completion times and for compliance with City Code Chapter 112, understands and agrees that the liquidated damages are for the non-quantifiable aspects of non-compliance and do not cover actual damages that may be shown and agrees that if awarded the Contract, all liquidated damage clauses form part of the Contract.

The Bidder declares that it has become fully familiar with the provisions of Chapter 14, Section 1:320 (Prevailing wages) and Chapter 23 (Living Wage) of the Code of the City of Ann Arbor and that it understands and agrees to comply, to the extent applicable to employees providing services to the City under this Contract, with the wage and reporting requirements stated in the City Code provisions cited. Bidder certifies that the statements contained in the City Prevailing Wage and Living Wage Declaration of Compliance Forms are true and correct. Bidder further agrees that the cited provisions of Chapter 14 and Chapter 23 form a part of this Contract.

The Bidder declares that it has become familiar with the City Conflict of Interest Disclosure Form and certifies that the statement contained therein is true and correct.

The Bidder encloses a certified check or Bid Bond in the amount of 5% of the total of the Bid Price. The Bidder agrees both to contract for the work and to furnish the necessary Bonds and insurance documentation within 10 days after being notified of the acceptance of the Bid.

If this Bid is accepted by the City and the Bidder fails to contract and furnish the required Bonds and insurance documentation within 10 days after being notified of the acceptance of this Bid, then the Bidder shall be considered to have abandoned the Contract and the certified check or Bid Bond accompanying this Bid shall become due and payable to the City.

If the Bidder enters into the Contract in accordance with this Bid, or if this Bid is rejected, then the accompanying check or Bid Bond shall be returned to the Bidder.

In submitting this Bid, it is understood that the right is reserved by the City to accept any Bid, to reject any or all Bids, to waive irregularities and/or informalities in any Bid, and to make the award in any manner the City believes to be in its best interest.

SIGNED THIS 14th DAY OF FEBRUARY, 2024

DOAN CONSTRUCTION CO.
Bidder's Name

3670 CARPENTER RD
YPSILANTI, MI 48197
Official Address

734-971-4678
Telephone Number



Authorized Signature of Bidder

JOHN SENKOWSKI
(Print Name of Signer Above)

jsenkowski@doancompanies.com
Email Address for Award Notice

ATTACHMENT C
LEGAL STATUS OF BIDDER

(The bidder shall fill out the appropriate form and strike out the other three.)

Bidder declares that it is:

* A corporation organized and doing business under the laws of the State of MICHIGAN, for whom JOHN SENKOWSKI, bearing the office title of MANAGER, whose signature is affixed to this Bid, is authorized to execute contracts.

NOTE: If not incorporated in Michigan, please attach the corporation's Certificate of Authority

~~A limited liability company doing business under the laws of the State of _____, whom _____ bearing the title of _____ whose signature is affixed to this proposal, is authorized to execute contract on behalf of the LLC.~~

~~* A partnership, organized under the laws of the state of _____ and filed in the county of _____, whose members are (list all members and the street and mailing address of each) (attach separate sheet if necessary):~~

~~_____

_____~~

* An individual, whose signature with address, is affixed to this Bid: _____ (initial here)

Authorized Official
 _____ Date FEBRUARY 14, 2024

(Print) Name JOHN SENKOWSKI Title MANAGER

Company: DOAN CONSTRUCTION CO.

Address: 3670 CARPENTER RD YPSILANTI, MI 48197

Contact Phone (734) 971-4678 Fax (734) 971-4415

Email j.senkowski@doancompanies.com

ATTACHMENT D
PREVAILING WAGE DECLARATION OF COMPLIANCE

The "wage and employment requirements" of Section 1:320 of Chapter 14 of Title I of the Ann Arbor City Code mandates that the city not enter any contract, understanding or other arrangement for a public improvement for or on behalf of the city unless the contract provides that all craftsmen, mechanics and laborers employed directly on the site in connection with said improvements, including said employees of subcontractors, shall receive the prevailing wage for the corresponding classes of craftsmen, mechanics and laborers, as determined by statistics for the Ann Arbor area compiled by the United States Department of Labor. Where the contract and the Ann Arbor City Code are silent as to definitions of terms required in determining contract compliance with regard to prevailing wages, the definitions provided in the Davis-Bacon Act as amended (40 U.S.C. 278-a to 276-a-7) for the terms shall be used. Further, to the extent that any employees of the contractor providing services under this contract are not part of the class of craftsmen, mechanics and laborers who receive a prevailing wage in conformance with section 1:320 of Chapter 14 of Title I of the Code of the City of Ann Arbor, employees shall be paid a prescribed minimum level of compensation (i.e. Living Wage) for the time those employees perform work on the contract in conformance with section 1:815 of Chapter 23 of Title I of the Code of the City of Ann Arbor.

At the request of the city, any contractor or subcontractor shall provide satisfactory proof of compliance with this provision.

The Contractor agrees:

- (a) To pay each of its employees whose wage level is required to comply with federal, state or local prevailing wage law, for work covered or funded by this contract with the City,
- (b) To require each subcontractor performing work covered or funded by this contract with the City to pay each of its employees the applicable prescribed wage level under the conditions stated in subsection (a) or (b) above.
- (c) To provide to the City payroll records or other documentation within ten (10) business days from the receipt of a request by the City.
- (d) To permit access to work sites to City representatives for the purposes of monitoring compliance, and investigating complaints or non-compliance.

The undersigned states that he/she has the requisite authority to act on behalf of his/her employer in these matters and has offered to provide the services in accordance with the terms of the wage and employment provisions of the Chapter 14 of the Ann Arbor City Code. The undersigned certifies that he/she has read and is familiar with the terms of Section 1:320 of Chapter 14 of the Ann Arbor City Code and by executing this Declaration of Compliance obligates his/her employer and any subcontractor employed by it to perform work on the contract to the wage and employment requirements stated herein. The undersigned further acknowledges and agrees that if it is found to be in violation of the wage and employment requirements of Section 1:320 of the Chapter 14 of the Ann Arbor City Code it shall have been deemed a material breach of the terms of the contract and grounds for termination of same by the City.

Doan Construction Co.
Company Name

[Signature] 2/14/2024
Signature of Authorized Representative Date

John Senkowski - MANAGER
Print Name and Title

3670 CARPENTER RD YPSILANTI MI 48197
Address, City, State, Zip

734-971-4678 jsenkowski@doancompanies.com
Phone/Email address

Questions about this form? Contact Procurement Office City of Ann Arbor Phone: 734/794-6500

ATTACHMENT E
LIVING WAGE ORDINANCE DECLARATION OF COMPLIANCE

The Ann Arbor Living Wage Ordinance (Section 1:811-1:821 of Chapter 23 of Title I of the Code) requires that an employer who is (a) a contractor providing services to or for the City for a value greater than \$10,000 for any twelve-month contract term, or (b) a recipient of federal, state, or local grant funding administered by the City for a value greater than \$10,000, or (c) a recipient of financial assistance awarded by the City for a value greater than \$10,000, shall pay its employees a prescribed minimum level of compensation (i.e., Living Wage) for the time those employees perform work on the contract or in connection with the grant or financial assistance. The Living Wage must be paid to these employees for the length of the contract/program.

Companies employing fewer than 5 persons and non-profits employing fewer than 10 persons are exempt from compliance with the Living Wage Ordinance. If this exemption applies to your company/non-profit agency please check here No. of employees__

The Contractor or Grantee agrees:

- (a) To pay each of its employees whose wage level is not required to comply with federal, state or local prevailing wage law, for work covered or funded by a contract with or grant from the City, no less than the Living Wage. The current Living Wage is defined as \$15.90/hour for those employers that provide employee health care (as defined in the Ordinance at Section 1:815 Sec. 1 (a)), or no less than \$17.73/hour for those employers that do not provide health care. The Contractor or Grantor understands that the Living Wage is adjusted and established annually on April 30 in accordance with the Ordinance and covered employers shall be required to pay the adjusted amount thereafter to be in compliance with Section 1:815(3).

Check the applicable box below which applies to your workforce

Employees who are assigned to any covered City contract/grant will be paid at or above the applicable living wage without health benefits

Employees who are assigned to any covered City contract/grant will be paid at or above the applicable living wage with health benefits

- (b) To post a notice approved by the City regarding the applicability of the Living Wage Ordinance in every work place or other location in which employees or other persons contracting for employment are working.
- (c) To provide to the City payroll records or other documentation within ten (10) business days from the receipt of a request by the City.
- (d) To permit access to work sites to City representatives for the purposes of monitoring compliance, and investigating complaints or non-compliance.
- (e) To take no action that would reduce the compensation, wages, fringe benefits, or leave available to any employee covered by the Living Wage Ordinance or any person contracted for employment and covered by the Living Wage Ordinance in order to pay the living wage required by the Living Wage Ordinance.

The undersigned states that he/she has the requisite authority to act on behalf of his/her employer in these matters and has offered to provide the services or agrees to accept financial assistance in accordance with the terms of the Living Wage Ordinance. The undersigned certifies that he/she has read and is familiar with the terms of the Living Wage Ordinance, obligates the Employer/Grantee to those terms and acknowledges that if his/her employer is found to be in violation of Ordinance it may be subject to civil penalties and termination of the awarded contract or grant of financial assistance.

DOAN CONSTRUCTION Co.
 Company Name

[Signature]
 Signature of Authorized Representative

 Date

3670 CAUSEWAY RD
 Street Address

YPSILANTI, MI 48197
 City, State, Zip

JOHN SENKOWSKI - MANAGER
 Print Name and Title

734-971-4678 jsenkowski@doancompanies.com
 Phone/Email address

Attachment F

CITY OF ANN ARBOR LIVING WAGE ORDINANCE

RATE EFFECTIVE APRIL 30, 2023 - ENDING APRIL 29, 2024

\$15.90 per hour

If the employer provides health care benefits*

\$17.73 per hour

If the employer does **NOT** provide health care benefits*

Employers providing services to or for the City of Ann Arbor or recipients of grants or financial assistance from the City of Ann Arbor for a value of more than \$10,000 in a twelve-month period of time must pay those employees performing work on a City of Ann Arbor contract or grant, the above living wage.

ENFORCEMENT

The City of Ann Arbor may recover back wages either administratively or through court action for the employees that have been underpaid in violation of the law. Persons denied payment of the living wage have the right to bring a civil action for damages in addition to any action taken by the City.

Violation of this Ordinance is punishable by fines of not more than \$500/violation plus costs, with each day being considered a separate violation. Additionally, the City of Ann Arbor has the right to modify, terminate, cancel or suspend a contract in the event of a violation of the Ordinance.

* Health Care benefits include those paid for by the employer or making an employer contribution toward the purchase of health care. The employee contribution must not exceed \$.50 an hour for an average work week; and the employer cost or contribution must equal no less than \$1/hr for the average work week.

The Law Requires Employers to Display This Poster Where Employees Can Readily See It.

**For Additional Information or to File a Complaint contact
Colin Spencer at 734/794-6500 or cspencer@a2gov.org**



ATTACHEMENT G

Vendor Conflict of Interest Disclosure Form
--

All vendors interested in conducting business with the City of Ann Arbor must complete and return the Vendor Conflict of Interest Disclosure Form in order to be eligible to be awarded a contract. Please note that all vendors are subject to comply with the City of Ann Arbor's conflict of interest policies as stated within the certification section below.

If a vendor has a relationship with a City of Ann Arbor official or employee, an immediate family member of a City of Ann Arbor official or employee, the vendor shall disclose the information required below.

1. No City official or employee or City employee's immediate family member has an ownership interest in vendor's company or is deriving personal financial gain from this contract.
2. No retired or separated City official or employee who has been retired or separated from the City for less than one (1) year has an ownership interest in vendor's Company.
3. No City employee is contemporaneously employed or prospectively to be employed with the vendor.
4. Vendor hereby declares it has not and will not provide gifts or hospitality of any dollar value or any other gratuities to any City employee or elected official to obtain or maintain a contract.
5. Please note any exceptions below:

Conflict of Interest Disclosure*	
Name of City of Ann Arbor employees, elected officials or immediate family members with whom there may be a potential conflict of interest.	<input type="checkbox"/> Relationship to employee <hr/> <input type="checkbox"/> Interest in vendor's company <input type="checkbox"/> Other (please describe in box below)
N/A	
N/A	

*Disclosing a potential conflict of interest does not disqualify vendors. In the event vendors do not disclose potential conflicts of interest and they are detected by the City, vendor will be exempt from doing business with the City.

I certify that this Conflict of Interest Disclosure has been examined by me and that its contents are true and correct to my knowledge and belief and I have the authority to so certify on behalf of the Vendor by my signature below:		
	734-971-4678	
Vendor Name	Vendor Phone Number	
	2/14/24	JOHN SENKOWSKI - MANAGER
Signature of Vendor Authorized Representative	Date	Printed Name of Vendor Authorized Representative

Questions about this form? Contact Procurement Office City of Ann Arbor Phone: 734/794-6500, procurement@a2gov.org

ATTACHMENT H

DECLARATION OF COMPLIANCE

Non-Discrimination Ordinance

The "non discrimination by city contractors" provision of the City of Ann Arbor Non-Discrimination Ordinance (Ann Arbor City Code Chapter 112, Section 9:158) requires all contractors proposing to do business with the City to treat employees in a manner which provides equal employment opportunity and does not discriminate against any of their employees, any City employee working with them, or any applicant for employment on the basis of actual or perceived age, arrest record, color, disability, educational association, familial status, family responsibilities, gender expression, gender identity, genetic information, height, HIV status, marital status, national origin, political beliefs, race, religion, sex, sexual orientation, source of income, veteran status, victim of domestic violence or stalking, or weight. It also requires that the contractors include a similar provision in all subcontracts that they execute for City work or programs.

In addition the City Non-Discrimination Ordinance requires that all contractors proposing to do business with the City of Ann Arbor must satisfy the contract compliance administrative policy adopted by the City Administrator. A copy of that policy may be obtained from the Purchasing Manager

The Contractor agrees:

- (a) To comply with the terms of the City of Ann Arbor's Non-Discrimination Ordinance and contract compliance administrative policy, including but not limited to an acceptable affirmative action program if applicable.
- (b) To post the City of Ann Arbor's Non-Discrimination Ordinance Notice in every work place or other location in which employees or other persons are contracted to provide services under a contract with the City.
- (c) To provide documentation within the specified time frame in connection with any workforce verification, compliance review or complaint investigation.
- (d) To permit access to employees and work sites to City representatives for the purposes of monitoring compliance, or investigating complaints of non-compliance.

The undersigned states that he/she has the requisite authority to act on behalf of his/her employer in these matters and has offered to provide the services in accordance with the terms of the Ann Arbor Non-Discrimination Ordinance. The undersigned certifies that he/she has read and is familiar with the terms of the Non-Discrimination Ordinance, obligates the Contractor to those terms and acknowledges that if his/her employer is found to be in violation of Ordinance it may be subject to civil penalties and termination of the awarded contract.

DOAN CONSTRUCTION CO.
Company Name

[Signature] 2/14/2024
Signature of Authorized Representative Date

JOHN SENKOWSKI - MANAGER
Print Name and Title

3670 CARPENTER RD YPSILANTI, MI 48197
Address, City, State, Zip

734-971-4678 jsenkowski@doancompanies.com
Phone/Email Address

Questions about the Notice or the City Administrative Policy, Please contact:
Procurement Office of the City of Ann Arbor
(734) 794-6500

ATTACHMENT I

CITY OF ANN ARBOR NON-DISCRIMINATION ORDINANCE

Relevant provisions of Chapter 112, Nondiscrimination, of the Ann Arbor City Code are included below.
You can review the entire ordinance at www.a2gov.org/humanrights.

Intent: It is the intent of the city that no individual be denied equal protection of the laws; nor shall any individual be denied the enjoyment of his or her civil or political rights or be discriminated against because of actual or perceived age, arrest record, color, disability, educational association, familial status, family responsibilities, gender expression, gender identity, genetic information, height, HIV status, marital status, national origin, political beliefs, race, religion, sex, sexual orientation, source of income, veteran status, victim of domestic violence or stalking, or weight.

Discriminatory Employment Practices: No person shall discriminate in the hire, employment, compensation, work classifications, conditions or terms, promotion or demotion, or termination of employment of any individual. No person shall discriminate in limiting membership, conditions of membership or termination of membership in any labor union or apprenticeship program.

Discriminatory Effects: No person shall adopt, enforce or employ any policy or requirement which has the effect of creating unequal opportunities according to actual or perceived age, arrest record, color, disability, educational association, familial status, family responsibilities, gender expression, gender identity, genetic information, height, HIV status, marital status, national origin, political beliefs, race, religion, sex, sexual orientation, source of income, veteran status, victim of domestic violence or stalking, or weight for an individual to obtain housing, employment or public accommodation, except for a bona fide business necessity. Such a necessity does not arise due to a mere inconvenience or because of suspected objection to such a person by neighbors, customers or other persons.

Nondiscrimination by City Contractors: All contractors proposing to do business with the City of Ann Arbor shall satisfy the contract compliance administrative policy adopted by the City Administrator in accordance with the guidelines of this section. All city contractors shall ensure that applicants are employed and that employees are treated during employment in a manner which provides equal employment opportunity and tends to eliminate inequality based upon any classification protected by this chapter. All contractors shall agree not to discriminate against an employee or applicant for employment with respect to hire, tenure, terms, conditions, or privileges of employment, or a matter directly or indirectly related to employment, because of any applicable protected classification. All contractors shall be required to post a copy of Ann Arbor's Non-Discrimination Ordinance at all work locations where its employees provide services under a contract with the city.

Complaint Procedure: If any individual believes there has been a violation of this chapter, he/she may file a complaint with the City's Human Rights Commission. The complaint must be filed within 180 calendar days from the date of the individual's knowledge of the allegedly discriminatory action or 180 calendar days from the date when the individual should have known of the allegedly discriminatory action. A complaint that is not filed within this timeframe cannot be considered by the Human Rights Commission. To file a complaint, first complete the complaint form, which is available at www.a2gov.org/humanrights. Then submit it to the Human Rights Commission by e-mail (hrc@a2gov.org), by mail (Ann Arbor Human Rights Commission, PO Box 8647, Ann Arbor, MI 48107), or in person (City Clerk's Office). For further information, please call the commission at 734-794-6141 or e-mail the commission at hrc@a2gov.org.

Private Actions For Damages or Injunctive Relief: To the extent allowed by law, an individual who is the victim of discriminatory action in violation of this chapter may bring a civil action for appropriate injunctive relief or damages or both against the person(s) who acted in violation of this chapter.

THIS IS AN OFFICIAL GOVERNMENT NOTICE AND
MUST BE DISPLAYED WHERE EMPLOYEES CAN READILY SEE IT.

MICHIGAN DEPARTMENT OF TRANSPORTATION CERTIFIED PAYROLL

COMPLETION OF CERTIFIED PAYROLL FORM FULFILLS THE MINIMUM MDOT PREVAILING WAGE REQUIREMENTS

(1) NAME OF CONTRACTOR / SUBCONTRACTOR (CIRCLE ONE) (2) ADDRESS

(3) PAYROLL NO. (4) FOR WEEK ENDING (5) PROJECT AND LOCATION (6) CONTRACT ID

(a)	(b)	(c)	(d) DAY AND DATE							(e)	(f)	(g)	(h)	(i)	(j) DEDUCTIONS						(k)
															TOTAL HOURS ON PROJECT	PROJECT RATE OF PAY	PROJECT RATE OF FRINGE PAY	GROSS PROJECT EARNED	GROSS WEEKLY EARNED	TOTAL WEEKLY HOURS WORKED ALL JOBS	
EMPLOYEE INFORMATION	WORK CLASSIFICATION	Hour Type	HOURS WORKED ON PROJECT							TOTAL HOURS ON PROJECT	PROJECT RATE OF PAY	PROJECT RATE OF FRINGE PAY	GROSS PROJECT EARNED	GROSS WEEKLY EARNED	TOTAL WEEKLY HOURS WORKED ALL JOBS	FICA	FEDERAL	STATE	OTHER	TOTAL DEDUCT	TOTAL WEEKLY WAGES PAID FOR ALL JOBS
NAME:									0				\$0.00							\$0.00	\$0.00
ETH#GEN: ID #:	GROUP/CLASS #:	S							0											\$0.00	\$0.00
NAME:									0				\$0.00							\$0.00	\$0.00
ETH#GEN: ID #:	GROUP/CLASS #:	S							0											\$0.00	\$0.00
NAME:									0				\$0.00							\$0.00	\$0.00
ETH#GEN: ID #:	GROUP/CLASS #:	S							0											\$0.00	\$0.00
NAME:									0				\$0.00							\$0.00	\$0.00
ETH#GEN: ID #:	GROUP/CLASS #:	S							0											\$0.00	\$0.00
NAME:									0				\$0.00							\$0.00	\$0.00
ETH#GEN: ID #:	GROUP/CLASS #:	S							0											\$0.00	\$0.00
NAME:									0				\$0.00							\$0.00	\$0.00
ETH#GEN: ID #:	GROUP/CLASS #:	S							0											\$0.00	\$0.00
NAME:									0				\$0.00							\$0.00	\$0.00
ETH#GEN: ID #:	GROUP/CLASS #:	S							0											\$0.00	\$0.00
NAME:									0				\$0.00							\$0.00	\$0.00

Date _____

I, _____ (Name of Signatory Party) _____ (Title)

do hereby state:

(1) That I pay or supervise the payment of the persons employed by

_____ on the _____ (Contractor or Subcontractor)
 _____; that during the payroll period commencing on the _____ (Building or Work)
 _____ day of _____, _____, and ending the _____ day of _____, _____,
 all persons employed on said project have been paid the full weekly wages earned, that no rebates have been or will be made either directly or indirectly to or on behalf of said

_____ from the full _____ (Contractor or Subcontractor)

weekly wages earned by any person and that no deductions have been made either directly or indirectly from the full wages earned by any person, other than permissible deductions as defined in Regulations, Part 3 (29 C.F.R. Subtitle A), issued by the Secretary of Labor under the Copeland Act, as amended (48 Stat. 948, 63 Stat. 108, 72 Stat. 967; 76 Stat. 357; 40 U.S.C. § 3145), and described below:

(2) That any payrolls otherwise under this contract required to be submitted for the above period are correct and complete; that the wage rates for laborers or mechanics contained therein are not less than the applicable wage rates contained in any wage determination incorporated into the contract; that the classifications set forth therein for each laborer or mechanic conform with the work he performed.

(3) That any apprentices employed in the above period are duly registered in a bona fide apprenticeship program registered with a State apprenticeship agency recognized by the Bureau of Apprenticeship and Training, United States Department of Labor, or if no such recognized agency exists in a State, are registered with the Bureau of Apprenticeship and Training, United States Department of Labor.

(4) That:

(a) WHERE FRINGE BENEFITS ARE PAID TO APPROVED PLANS, FUNDS, OR PROGRAMS

- in addition to the basic hourly wage rates paid to each laborer or mechanic listed in the above referenced payroll, payments of fringe benefits as listed in the contract have been or will be made to appropriate programs for the benefit of such employees, except as noted in section 4(c) below.

(b) WHERE FRINGE BENEFITS ARE PAID IN CASH

- Each laborer or mechanic listed in the above referenced payroll has been paid, as indicated on the payroll, an amount not less than the sum of the applicable basic hourly wage rate plus the amount of the required fringe benefits as listed in the contract, except as noted in section 4(c) below.

(c) EXCEPTIONS

EXCEPTION (CRAFT)	EXPLANATION
REMARKS:	
NAME AND TITLE	SIGNATURE
THE WILLFUL FALSIFICATION OF ANY OF THE ABOVE STATEMENTS MAY SUBJECT THE CONTRACTOR OR SUBCONTRACTOR TO CIVIL OR CRIMINAL PROSECUTION. SEE SECTION 1001 OF TITLE 18 AND SECTION 231 OF TITLE 31 OF THE UNITED STATES CODE.	

APPENDIX A: AREA MAPS

Area 24-01 Concrete Sidewalks

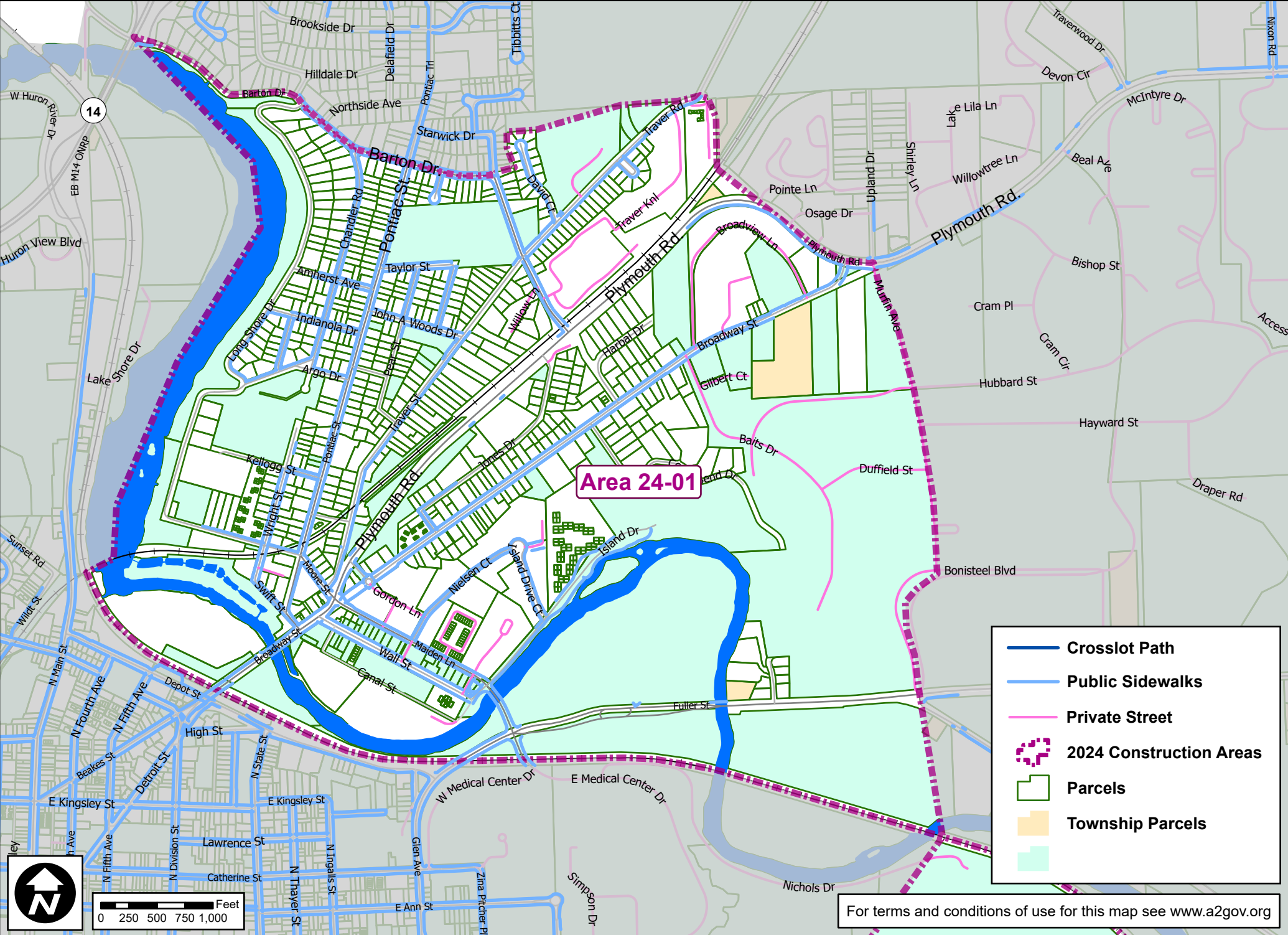

- Crosslot Path
- Public Sidewalks
- Private Street
- 2024 Construction Areas
- Parcels
- Township Parcels

For terms and conditions of use for this map see www.a2gov.org

Area 24-02 Concrete Sidewalks

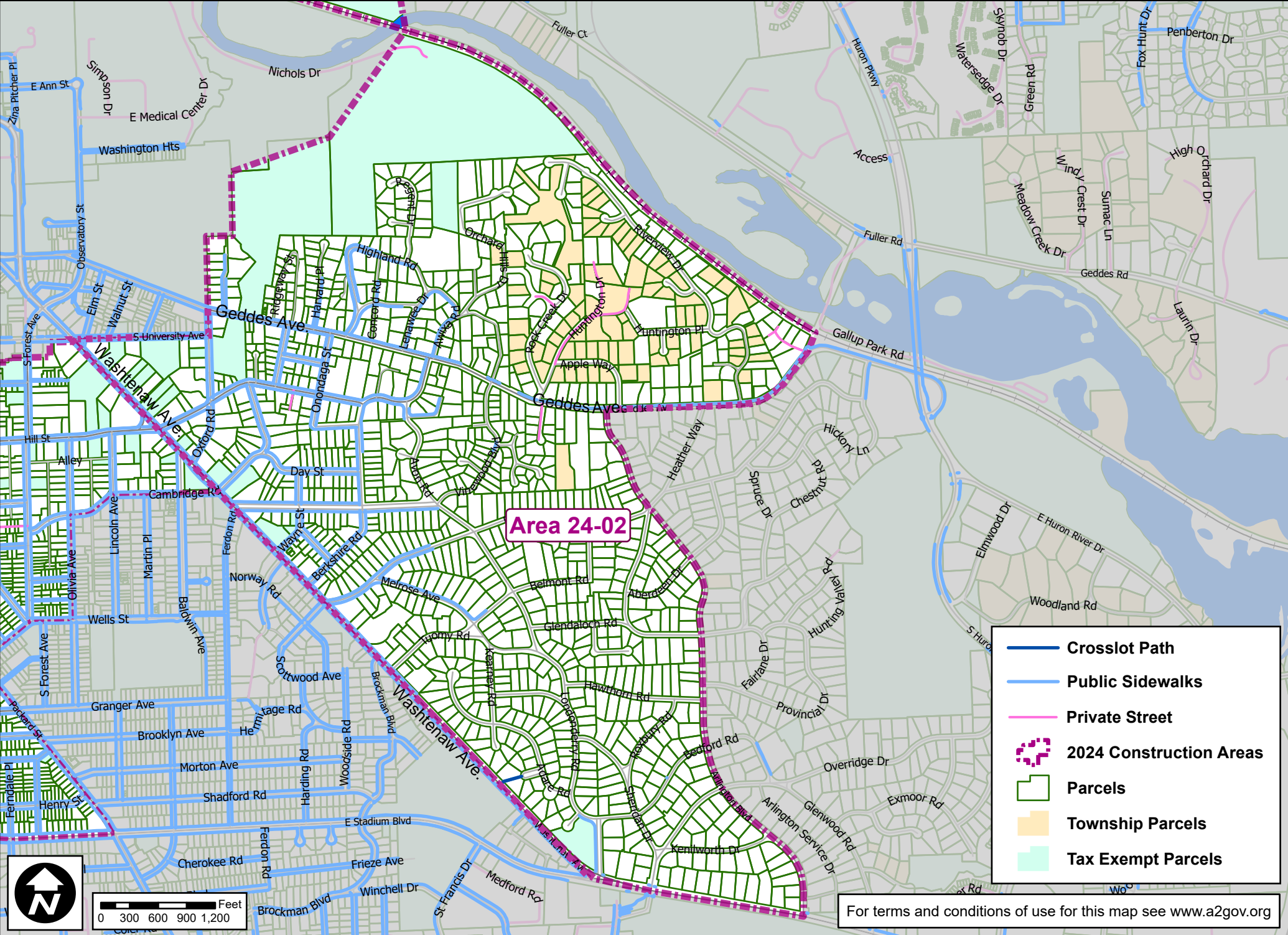

For terms and conditions of use for this map see www.a2gov.org

Area 24-03 Concrete Sidewalks

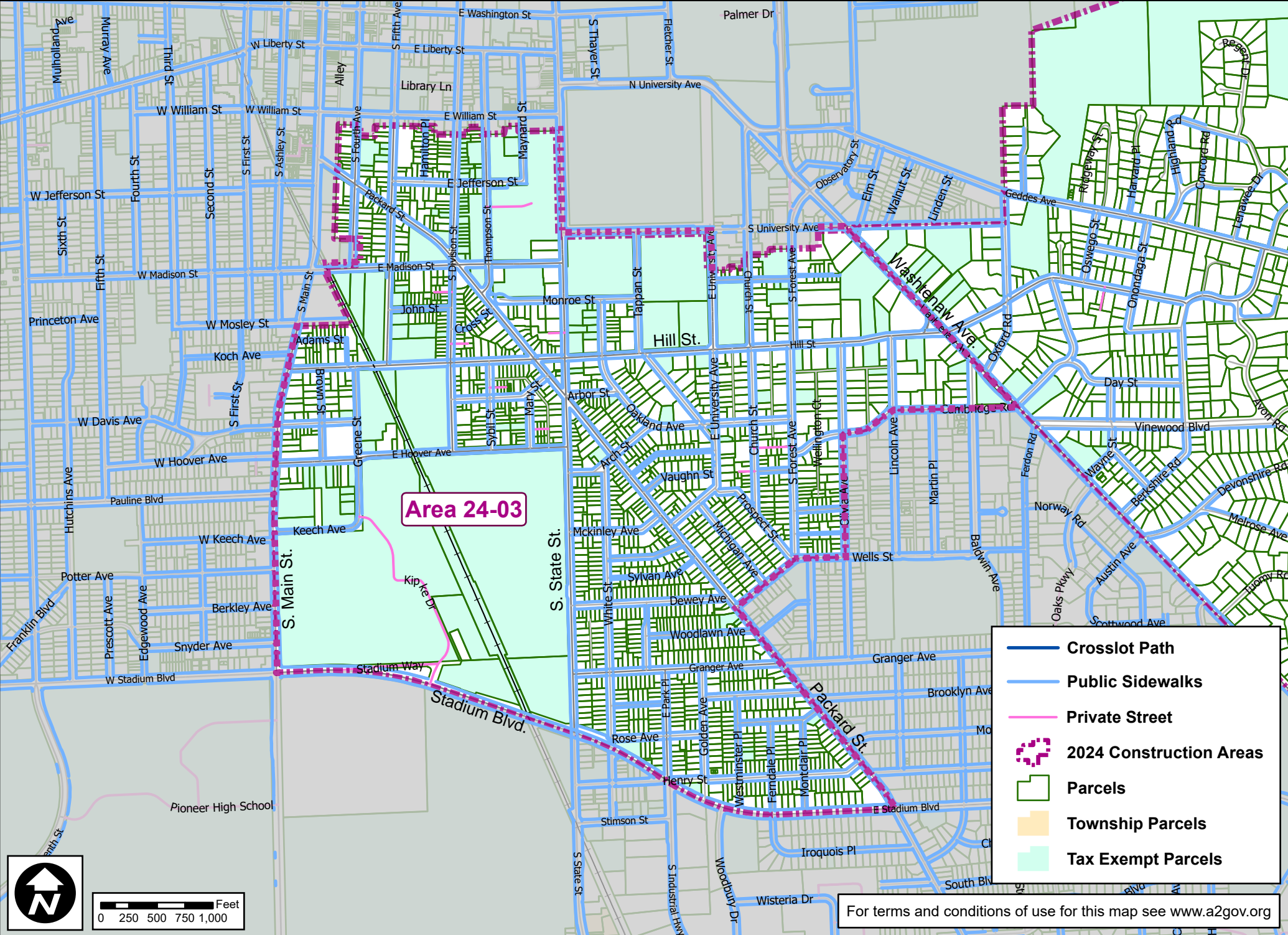

Area 24-03





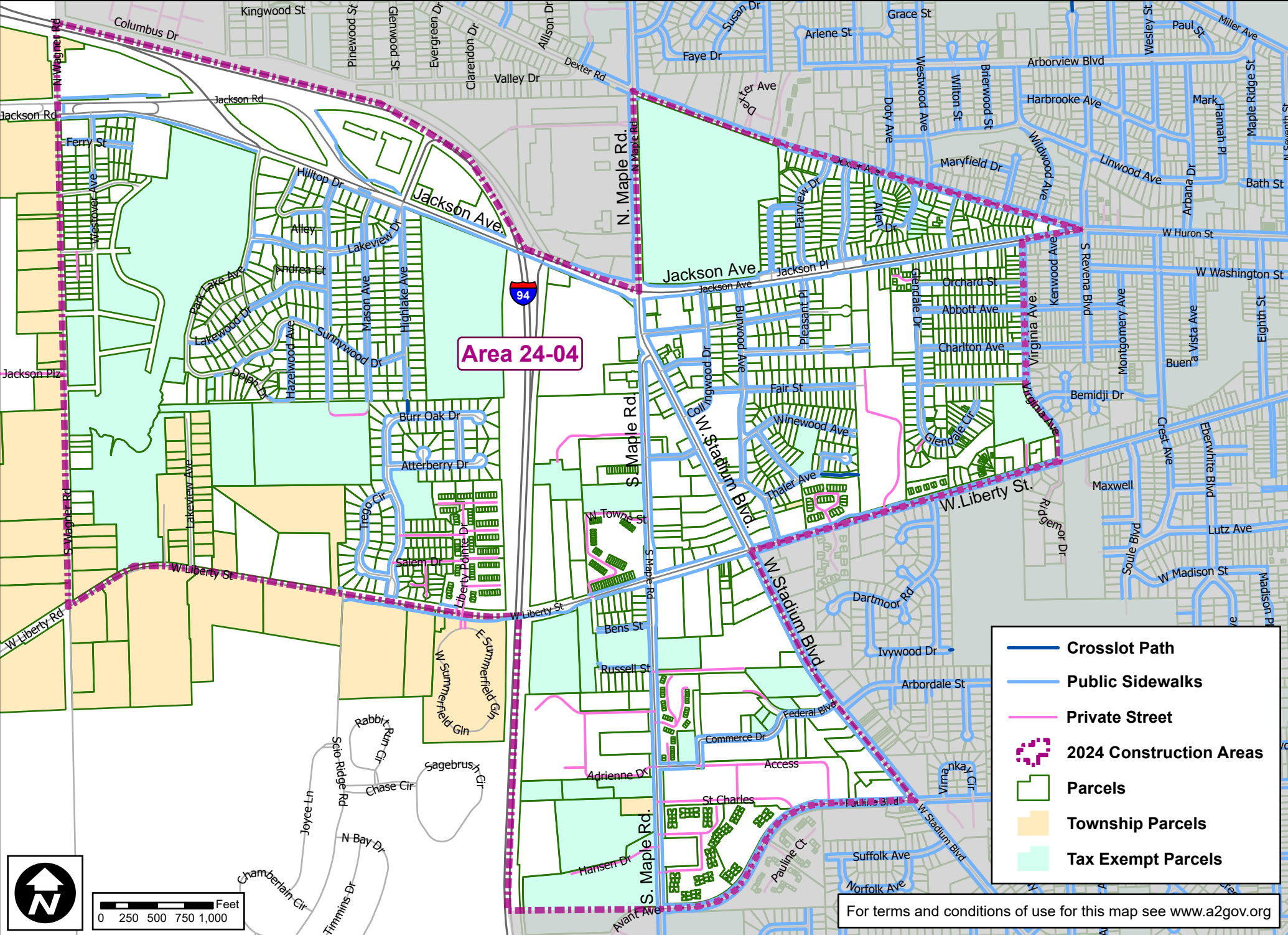

- Crosslot Path
- Public Sidewalks
- Private Street
- 2024 Construction Areas
- Parcels
- Township Parcels
- Tax Exempt Parcels

For terms and conditions of use for this map see www.a2gov.org

Area 24-04 Concrete Sidewalks



Area 24-04

-  Crosslot Path
-  Public Sidewalks
-  Private Street
-  2024 Construction Areas
-  Parcels
-  Township Parcels
-  Tax Exempt Parcels