



TRAFFIC IMPACT STUDY

For the Proposed

Nixon Property Condominiums

City of Ann Arbor, Washtenaw County, MI

**November, 2014
(Revised)**

Prepared by:

**Traffic Engineering
Associates, Inc.**

PO Box 100 • Saranac, Michigan 48881
517/627-6028 FAX: 517/627-6040

Table of Contents

Executive Summary		
Introduction		1
	Project Description	2
	Scope of Work	2
	Aerial Site Map	3
Existing Conditions		4
	Roadways and Intersections	5
	Land Use	7
	Existing Traffic Volumes	7
	Level of Service Analysis for Existing Traffic	9
Background Conditions		14
	Background Traffic Growth Volumes	15
	Background Development Traffic Volumes	15
	Level of Service Analysis for Background Traffic	19
	Level of Service Analysis for Mitigated Background Traffic	24
Future Conditions		27
	Site Traffic Generation	28
	Site Traffic Distribution	30
	Level of Service Analysis for Future Traffic	33
Future Mitigated Conditions		38
	Level of Service Analysis for Future Mitigated Traffic	39
Significant Findings		43
	Road Improvement Considerations	44
	Conclusions	48
Supplemental Information		49
	Site Plan	
	Vehicle Volume Counts	
	Census Population Estimates	
	Right Turn Lane Calculations	
	Left Turn Lane Calculations	
	Traffic Signal Warrant Calculation	
	LOS Computations	



List of Tables

Table	Title	Page
1	Level of Service (LOS) Summary – Existing AM & PM Peak Hour Traffic	12
2	Level of Service (LOS) Summary – Background AM & PM Peak Hour Traffic	22
3	Level of Service (LOS) Summary – Background Mitigated AM & PM Peak Hour Traffic	26
4	Vehicle Trip Generation Summary – Proposed Nixon Property Condominiums Development	29
5	Level of Service (LOS) Summary – Future AM & PM Peak Hour Traffic	36
6	Level of Service (LOS) Summary – Future Mitigated AM & PM Peak Hour Traffic	41
7	Level of Service (LOS) Summary – Future Mitigated AM & PM Peak Hour Traffic for the Nixon Road and Dhu Varren Road/Green Road Intersection	46

List of Figures

Figure	Title	Page
1	Existing Traffic – Peak Hours	8
2A	Background Growth Traffic – Peak Hours	16
2B	Background Development Traffic – Peak Hours	17
2C	Total Background Traffic – Peak Hours	18
3	Proposed Site Traffic – Peak Hours	31
4	Future Traffic – Peak Hours	32



EXECUTIVE SUMMARY

Traffic Engineering Associates, Inc. (TEA) conducted a traffic impact study to determine the distribution of the new traffic generated by the proposed Nixon Property Condominiums development in the City of Ann Arbor, Washtenaw County, Michigan. The project site is located on the west side of Nixon Road from the M-14/US-23 highway to a point south of Dhu Varren Road. The proposed development will consist of 473 condominiums on 108.97 acres. The property is currently vacant. The new development is anticipated to be constructed in phases, with completion and occupation in eight (8) years.

Access to the proposed Nixon Property Condominiums development will be provided via two (2) new access roads located on Nixon Road, one (1) north of Dhu Varren Road and one (1) south of Dhu Varren Road. In addition, there will be two (2) new access roads located on Dhu Varren Road, one (1) on the south side and one (1) on the north side.

TEA, Inc. conducted vehicle counts during the week of June 2, 2014, as well as additional counts the week of November 3, 2014. The 2014 traffic counts for this study were taken prior to the dismissal of the K-12 school system in the City of Ann Arbor. It was requested by the City that the intersection of Plymouth Road and Huron Parkway be added to the traffic study after school dismissal for the summer; therefore, the City of Ann Arbor provided the traffic volumes at this intersection from a previous study, and the traffic counts were adjusted for 2014. The weekday AM and PM peak hours of existing traffic on the adjoining road system are 8:00 – 9:00 AM and 5:00 – 6:00 PM, respectively.

The intersections for this study were analyzed according to the methodologies published in the most recent edition of the *Highway Capacity Manual*. The analysis determines the “Level of Service” (LOS) of the intersections and is defined by average vehicle delay in seconds created by a traffic control device for a given traffic movement, or intersection approach. Level of Service is expressed in a range from “A” to “F,” with “A” being the highest LOS and “F” representing the lowest LOS. Level of service “D” is considered the minimum acceptable LOS in most urban areas.

The existing intersections analyzed in the study consisted of the following;

- Nixon Road and Barclays Way
- Nixon Road and Dhu Varren Road
- Nixon Road and Green Road
- Nixon Road and Haverhill Court
- Nixon Road and Meade Court/Bluett Drive
- Nixon Road and Huron Parkway
- Nixon Road and Plymouth Road
- Huron Parkway and Plymouth Road

All existing turning movements at the studied intersections operate at an acceptable level of service (LOS D or better) during the AM and PM peak hours except movements at the Nixon Road and Meade Court/Bluett Drive intersection, Nixon Road and Plymouth Road intersection



and Huron Parkway and Plymouth Road intersection which had level of service values from “E” to “F.”

Background traffic represents future volumes without the traffic generated by the proposed Nixon Property Condominiums development. The new development is anticipated to be constructed in phases, with completion and occupation in eight (8) years.

Population growth is the driving force behind area-wide traffic growth. According to the most recent Quick Facts sheet from the US Census Bureau (July 2010), from 2000-2010 the City of Ann Arbor had a total growth of negative zero point six seven percent (-0.67%). However, the census data also shows that from 2010 to 2013 there was a two point seven percent (2.7%) growth rate. For this study, the two point seven percent (2.7%) growth rate from 2010 to 2013 was used for the eight (8) year background growth rate to project traffic to the build out date of 2022.

The City of Ann Arbor provided information for two (2) new developments, Traverwood Apartments and Woodbury Club Apartments, which might influence the background traffic on Nixon Road and Plymouth Road. The Traverwood Apartments development will be located on the west side of Traverwood Road, between Huron Parkway and Plymouth Road, which is approximately one-quarter mile west of Nixon Road. The Woodbury Club Apartments development will be located in the southeast corner of Nixon Road and M-14/US-23, and directly across from the proposed Nixon Property Condominiums development.

Using the traffic impact study developed by Midwestern Consulting, LLC in May, 2013, and the traffic impact study also developed by Midwestern Consulting, LLC in August, 2013, the site generated traffic from the proposed Traverwood Apartments and the Woodbury Club Apartments developments were used as background development traffic. Traffic was distributed based on existing traffic volume patterns.

Under background conditions, all of the studied intersections had turning movements with level of service values from “E” to “F.” With the increase in vehicle demands, background mitigation recommendations were made to reduce vehicle delays, which included the possible installation of a 4-way stop at the intersection of Nixon Road and Meade Court/Bluett Drive and changing the protected left turn phasing to a permissive/protected, lagging left turn phase for all left turn approaches at the intersections of Nixon Road at Plymouth Road, and Huron Parkway at Plymouth Road.

With the recommended mitigation improvements, there was a significant drop in vehicle delay for background mitigated conditions at the studied intersections. While several movements still operate poorly, the recommended improvements significantly reduced the number of movements at the studied intersections with levels of service “E” or “F.”

The trip generation rates for the Nixon Property Condominiums development were derived from the ITE TRIP GENERATION MANUAL (9th edition). The ITE trip generation rates for Luxury Condominium/ Townhouse (Land Use Code 233) were selected as representing the proposed 473 Units. It is projected that the proposed Nixon Property Condominiums development will



generate 265 vehicle trips in the AM peak hour, 260 vehicle trips in the PM peak hour and 2,486 vehicle trips daily.

For future traffic conditions, all existing geometrics and traffic control were used, with the exception of one location. The intersection of Nixon Road and Dhu Varren/Green Road was aligned so that Dhu Varren Road and Green Road were directly opposite each other, with an eastbound center left turn lane added to Dhu Varren Road to match the existing westbound center left turn lane on Green Road, per the proposed site plans. The proposed four (4) site driveways were modeled as one (1) entering lane and one (1) exiting lane.

Under future conditions, as was seen with background conditions, there are movements at each studied intersection with level of service values from “E” to “F.” The proposed site driveways, however, are expected to operate at a good level of service (LOS C or better).

The future mitigated level of service conditions determines the impact that can be expected from the addition of traffic generated from the Nixon Property Condominiums development, with changes to the roadway geometrics and traffic control devices to mitigate vehicle delay.

At the intersection of Nixon Road and Dhu Varren/Green Road, several recommendations were made to reduce vehicle delay. The intersection was aligned as detailed on the site plan with a center left turn lane added to Dhu Varren Road to match the existing center left turn lane on Green Road. In addition, center left turn lanes were added to the northbound and southbound Nixon Road approaches, along with exclusive right turn lanes for the northbound, eastbound and westbound approaches. This intersection will need a new traffic control method, which is discussed in detail in the report.

The intersection of Nixon Road and Meade Court/Bluett Drive was changed from the existing 2-way to a 4-way stop control, which was recommended under background mitigated conditions.

The traffic signal phasing at the intersections of Nixon Road at Plymouth Road and Huron Parkway at Plymouth Road was changed from the existing protected leading left turns to permissive/protected lagging left turns for all four (4) approaches. This recommendation was made under background mitigated conditions to alleviate background delays as well.

At the north and south proposed site driveways on Nixon Road, new head-up northbound center left turn lanes were added.

With the driveway and intersection improvements, the future mitigated turning movements will see improvement during the AM and PM peak hours to vehicle delay and a significant reduction in the number of movements at the studied intersections with levels of service “E” or “F.”

The findings of the study recommend aligning Dhu Varren Road with Green Road as shown on the site plan. A new traffic control should be provided for the newly aligned intersection with a 4-way stop, roundabout or a traffic signal, whichever the City of Ann Arbor deems appropriate for this intersection. In addition, a new eastbound center left turn lane on Dhu Varren Road should be constructed, opposite the existing center left turn lane on Green Road. New head up

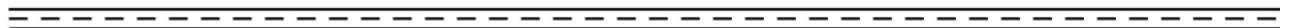

northbound and southbound center left turn lanes should also be provided on Nixon Road at the Dhu Varren Road/Green Road intersection. New exclusive right turn lanes should be added on eastbound Dhu Varren Road, westbound Green Road and northbound Nixon Road.

At the intersection of Nixon Road and Meade Court/Bluett Drive, the City of Ann Arbor should evaluate potentially replacing the 2-way stop with a 4-way stop.

New head up northbound and southbound center left turn lanes should be provided on Nixon Road at the North Site Driveway/Barclays Way intersection.

New head up northbound and southbound center left turn lanes should be provided on Nixon Road at the South Site Driveway/Haverhill Court intersection.

The City of Ann Arbor should review the traffic signal timing and phasing at the intersections of Nixon Road and Plymouth Road, and Huron Parkway and Plymouth Road to determine if the existing leading protected green arrow phase could be replaced with a new permissive/protected lagging left turn phase at each intersection and determine if this would fit into their traffic control system to improve the level of service and reduce the vehicle delays at both of these intersections.

It is further recommended that if the developer would like some type of landscaping or development signing in a boulevard design, that an island be constructed back away from the crossroad a sufficient distance to provide for head up center left turn lanes.

Respectfully Submitted,

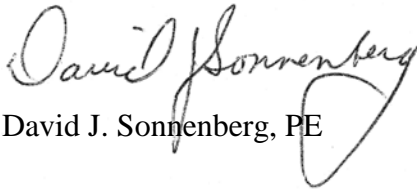

David J. Sonnenberg, PE



INTRODUCTION

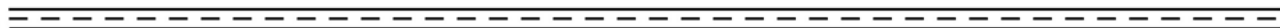

PROJECT DESCRIPTION

The purpose of this study is to determine the distribution of the new traffic generated by the proposed Nixon Property Condominiums development in the City of Ann Arbor, Washtenaw County, Michigan. The project site is located on the west side of Nixon Road from M-14/US-23 highway to a point south of Dhu Varren Road. The proposed development will consist of 473 condominiums on 108.97 acres. The property is currently vacant. The new development is anticipated to be constructed in phases, with completion and occupation in eight (8) years.

Access to the proposed Nixon Property Condominiums development will be provided via two (2) new access roads located on Nixon Road, one (1) north of Dhu Varren Road and one (1) south of Dhu Varren Road. Also, there will be two (2) new access roads located on Dhu Varren Road, one (1) on the south side and one (1) on the north side.

SCOPE OF WORK

The scope of work contained in this report is as follows:

- Analysis of existing traffic conditions on the adjoining street system, including the following intersections;
 - Nixon Road and Barclays Way
 - Nixon Road and Dhu Varren Road
 - Nixon Road and Green Road
 - Nixon Road and Haverhill Court
 - Nixon Road and Meade Court/Bluett Drive
 - Nixon Road and Huron Parkway
 - Nixon Road and Plymouth Road
 - Huron Parkway and Plymouth Road
- Analyses of background traffic conditions on the adjoining street system which includes the above listed intersections for the future year 2022 volumes without the proposed Nixon Property Condominiums development. Also included are two (2) background developments, Traverwood Apartments and Woodbury Club Apartments.
- Projection of future traffic volumes to be generated by the proposed Nixon Property Condominiums development for the future year.
- Analysis of the impact of future traffic for the proposed Nixon Property Condominiums development at the above listed intersections.





Aerial Site Map



EXISTING CONDITIONS



ROADWAYS AND INTERSECTIONS

Nixon Road is a two-lane paved road with a gravel shoulder on the west side and curb and gutter on the east side. There is a marked bike path on both sides of Nixon Road. Nixon Road is under the jurisdiction of the City of Ann Arbor with a posted speed limit of 35 MPH north of Dhu Varren Road and a posted speed limit of 30 MPH south of Dhu Varren Road. There is an existing sidewalk along the east side of Nixon Road across the frontage of the proposed site.

The intersection of Nixon Road and Barclays Way is a “T” intersection and is controlled by a stop sign on westbound Barclays Way. The east approach on Barclays Way is a two-lane roadway with one (1) left-right lane and one (1) outbound lane. The north and south approaches on Nixon Road are a two-lane roadway with one (1) thru-right lane and one (1) outbound lane. There are bike paths on both sides of Nixon Road.

The intersection of Nixon Road and Dhu Varren Road is a “T” intersection and is controlled by a stop sign on eastbound Dhu Varren Road and a stop sign on southbound Nixon Road. The west approach on Dhu Varren Road is a two-lane roadway with one (1) left-right lane and one (1) outbound lane. The north approach on Nixon Road is a two-lane roadway with one (1) thru-right lane and one (1) outbound lane. There are bike paths on both sides of Nixon Road.

Approximately 90 feet south of Dhu Varren Road is another “T” intersection, Green Road, which runs east from Nixon Road. Even though there is a 90 foot separation between Dhu Varren Road and Green Road, the City of Ann Arbor has installed a 4-way stop control for these two (2) intersections so that they operate as a single intersection.

The intersection of Green Road and Nixon Road is a “T” intersection and is controlled by a stop sign on westbound Green Road, and a stop sign on northbound Nixon Road. The east approach on Green Road is a three-lane roadway with one (1) exclusive right turn lane, one (1) exclusive left turn lane and one (1) outbound lane. The south approach on Nixon Road is a two-lane roadway with one (1) thru-right lane and one (1) outbound lane. There are bike paths on both sides of Nixon Road.

The intersection of Nixon Road and Haverhill Court is a “T” intersection and is controlled by a stop sign on westbound Haverhill Court. The east approach on Haverhill Court is a two-lane roadway with one (1) left-right lane and one (1) outbound lane. The north and south approaches on Nixon Road are a two-lane roadway with one (1) thru-right lane and one (1) outbound lane. There are bike paths on both sides of Nixon Road.

The intersection of Meade Court/Bluett Drive and Nixon Road is a four-way intersection with an offset between Meade Court and Bluett Drive of approximately 30 feet. The intersection is controlled by eastbound and westbound stop signs. The west approach on Meade Court is a two-lane roadway with one (1) left-thru-right lane and one (1) outbound lane. The east approach on Bluett Drive is a two-lane roadway with one (1) left-thru-right lane and one (1) outbound lane. The north approach on Nixon Road is a three-lane roadway with one (1) exclusive left turn lane, one (1) thru-right lane and one (1) outbound lane. The south approach on Nixon road is a two-



lane roadway with one (1) left-thru-right lane and one (1) outbound lane. There are bike paths on both sides of Nixon Road.

The intersection of Nixon Road and Huron Parkway is a four-way intersection and the traffic is controlled by a modern roundabout with yield signs in all four entrances.

The intersection of Nixon Road and Plymouth Road is a four-way intersection and is controlled by a traffic signal. The north approach on Nixon Road is a three-lane roadway with one (1) exclusive left turn lane, one (1) thru-right lane and one (1) outbound lane. The south approach on Nixon Road is a private roadway onto the U of M Campus with three lanes, one (1) exclusive left turn lane, one (1) thru-right lane and one (1) outbound lane. The east and west approaches on Plymouth Road are both five-lane roadways with one (1) exclusive left turn lane, one (1) thru-right lane, one (1) thru lane and two (2) outbound lanes. There are bike paths on the north approach of Nixon Road.

The intersection of Huron Parkway and Plymouth Road is a four-way intersection and is controlled by a traffic signal. The north approach on Huron Parkway is a five-lane roadway with one (1) exclusive left turn lane, one (1) thru-right lane, one (1) thru lane and two (2) outbound lanes. The south approach on Huron Parkway is a six (6) lane roadway, one (1) exclusive left turn lane, one (1) exclusive right turn lane, two (2) thru lanes and two (2) outbound lanes. The east and west approaches on Plymouth Road are both five-lane roadways with one (1) exclusive left turn lane, one (1) thru-right lane, one (1) thru lane and two (2) outbound lanes.



LAND USE

To the north of the proposed development is the M-14/US-23 highway. To the east, west and south is existing residential development. The proposed site property is vacant land.

EXISTING TRAFFIC VOLUMES

TEA, Inc. conducted vehicle counts midweek during the week of June 2, 2014, at the following intersections:

- Nixon Road and Dhu Varren Road
- Nixon Road and Green Road
- Nixon Road and Meade Court/Bluett Drive
- Nixon Road and Huron Parkway
- Nixon Road and Plymouth Road

The 2014 traffic counts for this study were taken prior to the dismissal of the K-12 school system in the City of Ann Arbor. It was requested that the intersection of Plymouth Road and Huron Parkway be added to the traffic study after school dismissal; therefore, the City of Ann Arbor provided the traffic volumes at this intersection from a previous study, and the traffic counts were adjusted for 2014.

TEA, Inc. conducted additional midweek vehicle counts during the week of November 3, 2014, at the following intersections:

- Nixon Road and Barclays Way
- Nixon Road and Haverhill Court

The weekday AM and PM peak hours of existing traffic on the adjoining road system are 8:00 – 9:00 AM and 5:00 – 6:00 PM, respectively. The existing peak hour volumes are illustrated in **Figure 1**.



Nixon Road Development

Nixon Road Development

Dhu Varren

Meade

Barclays

Green

Haverhill

Bluett

Huron Pkwy

Plymouth

Huron Pkwy

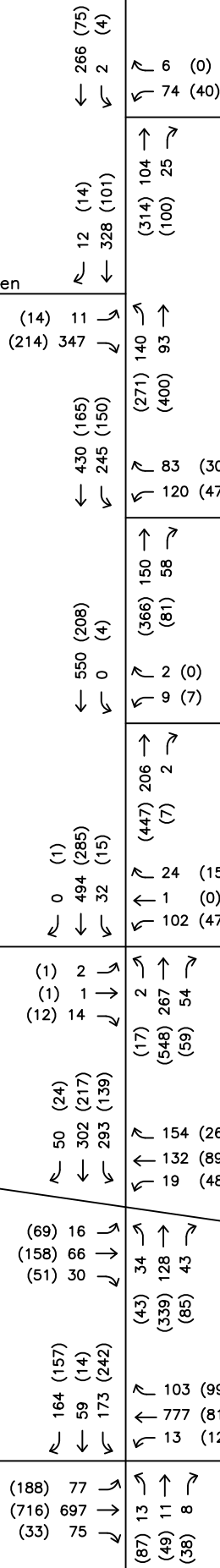

FIGURE 1: Existing Traffic – Peak Hours

LEGEND
 XXX AM Pk Hr (8:00–9:00 AM) Volumes
 (XXX) PM Pk Hr (5:00–6:00 PM) Volumes

TRAFFIC ENGINEERING ASSOCIATES, INC.
 PO Box 10881
 Saranac, MI 49881
 PHONE: (517) 627-6028



SCALE: NTS

DATE: November, 2014

PAGE: 8

LEVEL OF SERVICE ANALYSIS FOR EXISTING TRAFFIC

The critical intersections defined for this study were analyzed according to the methodologies published in the most recent edition of the *Highway Capacity Manual*. The analysis determines the “Level of Service” of the intersections and is based on factors such as the number and types of lanes, signal timing, traffic volumes, pedestrian activity, etc. The level of service (LOS) is defined by average vehicle delay in seconds created by a traffic control device for a given traffic movement or intersection approach.

Level of Service	Delay per Vehicle (seconds)	
	Non-Signalized	Signalized
A	< 10	<10
B	10 to 15	10 to 20
C	15 to 25	20 to 35
D	25 to 35	35 to 55
E	35 to 50	55 to 80
F	> 50	> 80

Levels of Service are expressed in a range from “A” to “F,” with “A” being the highest LOS and “F” representing the lowest LOS. Level of service “D” is considered the minimum acceptable LOS in an urban area.

The above table shows the thresholds for Levels of Service “A” through “F” for non-signalized and signalized intersections, respectively.

All Level of Service computations contained in this report were based upon the Synchro 8 software package which is approved by the Michigan Department of Transportation (MDOT). Delay per vehicle includes initial deceleration delay, queue move-up time, stopped delay, and final acceleration delay.

The Level of Service analysis for existing traffic at the subject intersections during the AM and PM peak hours is summarized in **Table 1**.

All existing turning movements at the studied intersections operate at an acceptable level of service (LOS D or better) during the AM and PM peak hours except for the following movements;

- Nixon Road and Green Road, the southbound thru-left traffic during the AM peak hour operates at a LOS F with a vehicle delay of 105.5 seconds.
- Nixon Road and Meade Court/Bluett Drive westbound left-thru-right traffic during the AM peak hour operates at a LOS F with a vehicle delay of 143.5 seconds.



- Nixon Road and Plymouth Road eastbound left turning traffic during the AM peak hour operates at a LOS E with a vehicle delay of 62.7 seconds.
- Nixon Road and Plymouth Road westbound left turning traffic during the AM peak hour operates at a LOS F with a vehicle delay of 81.5 seconds.
- Nixon Road and Plymouth Road northbound left turning traffic during the AM peak hour operates at a LOS E with a vehicle delay of 58.0 seconds.
- Nixon Road and Plymouth Road southbound left turning traffic during the AM peak hour operates at a LOS F with a vehicle delay of 110.3 seconds.
- Huron Parkway and Plymouth Road westbound left turning traffic during the AM peak hour operates at a LOS E with a vehicle delay of 60.0 seconds.
- Huron Parkway and Plymouth Road northbound left turning traffic during the AM peak hour operates at a LOS E with a vehicle delay of 62.6 seconds.
- Huron Parkway and Plymouth Road southbound left turning traffic during the AM peak hour operates at a LOS F with a vehicle delay of 92.7 seconds.
- Nixon Road and Dhu Varren Road, the northbound thru-left traffic during the PM peak hour operates at a LOS F with a vehicle delay of 63.9 seconds.
- Nixon Road and Plymouth Road eastbound left turning traffic during the PM peak hour operates at a LOS E with a vehicle delay of 59.3 seconds.
- Nixon Road and Plymouth Road westbound left turning traffic during the PM peak hour operates at a LOS E with a vehicle delay of 63.8 seconds.
- Nixon Road and Plymouth Road northbound left turning traffic during the PM peak hour operates at a LOS E with a vehicle delay of 65.8 seconds.
- Nixon Road and Plymouth Road southbound left turning traffic during the PM peak hour operates at a LOS F with a vehicle delay of 171.3 seconds.
- Huron Parkway and Plymouth Road eastbound left turning traffic during the PM peak hour operates at a LOS E with a vehicle delay of 58.1 seconds.
- Huron Parkway and Plymouth Road westbound left turning traffic during the PM peak hour operates at a LOS E with a vehicle delay of 63.4 seconds.
- Huron Parkway and Plymouth Road northbound left turning traffic during the PM peak hour operates at a LOS E with a vehicle delay of 70.3 seconds.



- Huron Parkway and Plymouth Road northbound thru traffic during the PM peak hour operates at a LOS E with a vehicle delay of 56.9 seconds.
- Huron Parkway and Plymouth Road southbound left turning traffic during the PM peak hour operates at a LOS E with a vehicle delay of 75.2 seconds.

The level of service “F” at the intersection of Nixon Road and Dhu Varren Road for the southbound movement during the AM peak hour, and again the level of service for the northbound movement during the PM peak hour is due to the pattern of commuter traffic at this 4-way stop intersection.

The two (2) signalized intersections, Nixon Road at Plymouth Road, and Huron Parkway at Plymouth Road show an existing level of service of “E” or “F” at all of the left turn movements, during both AM peak hour and the PM peak hour. Both signals operate with a protected leading left turn arrow for their left turn movements.



Table 1
Level of Service (LOS) Summary
Existing AM and PM Peak Hour Traffic

Location	Movement	Weekday AM Peak Hour		Weekday PM Peak Hour	
		Avg. Delay	LOS	Avg. Delay	LOS
Nixon Road and Dhu Varren Road	EB Left-Thru-Right	15.5	C	12.4	B
	NB Left-Thru	17.4	C	<u>63.9</u>	<u>F</u>
	SB Thru-Right	16.8	C	10.0	A
Nixon Road and Green Road	WB Left	13.2	B	10.0	B
	WB Right	9.8	B	15.5	C
	NB Thru-Right	14.8	B	24.5	C
	SB Thru-Left	<u>105.5</u>	<u>F</u>	16.7	C
Nixon Road and Meade Court/Bluett Drive	EB Left-Thru-Right	15.2	C	12.0	B
	WB Left-Thru-Right	<u>143.5</u>	<u>F</u>	27.6	D
	NB Left-Thru-Right	0.1	A	0.4	A
	SB Left	8.3	A	8.8	A
	SB Thru-Right	0.0	A	0.0	A
Nixon Road and Huron Parkway (Roundabout)	EB	11.3	B	13.9	B
	WB	8.9	A	23.3	C
	NB	9.7	A	22.7	C
	SB	32.5	D	11.2	B
	Intersection	21.5	C	18.2	C
Nixon Road and Plymouth Road	EB Left	<u>62.7</u>	<u>E</u>	<u>59.3</u>	<u>E</u>
	EB Thru-Right	15.3	B	15.8	B
	WB Left	<u>81.5</u>	<u>F</u>	<u>63.8</u>	<u>E</u>
	WB Thru-Right	11.5	B	24.6	C
	NB Left	<u>58.0</u>	<u>E</u>	<u>65.8</u>	<u>E</u>
	NB Thru-Right	32.7	C	50.2	D
	SB Left	<u>110.3</u>	<u>F</u>	<u>171.3</u>	<u>F</u>
	SB Thru-Right	40.5	D	15.7	B
Intersection	27.8	C	41.2	D	



Table 1
Level of Service (LOS) Summary
Existing AM and PM Peak Hour Traffic (continued)

Location	Movement	Weekday AM Peak Hour		Weekday PM Peak Hour	
		Avg. Delay	LOS	Avg. Delay	LOS
Huron Parkway and Plymouth Road	EB Left	44.0	D	<u>58.1</u>	<u>E</u>
	EB Thru-Right	21.6	C	29.4	C
	WB Left	<u>60.0</u>	<u>E</u>	<u>63.4</u>	<u>E</u>
	WB Thru-Right	16.8	B	22.3	C
	NB Left	<u>62.6</u>	<u>E</u>	<u>70.3</u>	<u>E</u>
	NB Thru	55.0	D	<u>56.9</u>	<u>E</u>
	NB Right	18.6	B	29.3	C
	SB Left	<u>92.7</u>	<u>F</u>	<u>75.2</u>	<u>E</u>
	SB Thru-Right	49.2	D	50.0	D
	Intersection	31.0	C	38.5	D
Nixon Road and Barclays Way	WB Left-Right	12.3	B	12.9	A
	NB Thru-Right	0.0	A	0.0	A
	SB Thru-Left	0.1	A	0.5	A
	Intersection	2.4	A	1.4	A
Nixon Road and Haverhill Court	WB Left-Right	16.3	C	14.2	B
	NB Thru-Right	0.0	A	0.0	A
	SB Thru-Left	0.0	A	0.2	A
	Intersection	0.3	A	0.3	A

Note: Delay = Average control delay per vehicle in seconds.
LOS = Level of Service



BACKGROUND CONDITIONS

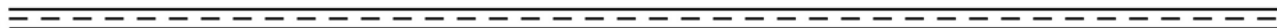

BACKGROUND TRAFFIC GROWTH VOLUMES

Background traffic represents future volumes without the traffic generated by the proposed Nixon Property Condominiums development. The new development is anticipated to be constructed in phases, with completion and occupation in eight (8) years.

Population growth is the driving force behind area-wide traffic growth. According to the most recent Quick Facts sheet from the US Census Bureau (July 2010), from 2000-2010 the City of Ann Arbor had a total growth of negative zero point six seven percent (-0.67%). However, the census data also shows that from 2010 to 2013 there was a two point seven percent (2.7%) growth rate. For this study, the two point seven percent (2.7%) growth rate from 2010 to 2013, was used for the eight (8) year background growth rate to project traffic to the build out date of 2022. Background traffic growth volumes during the AM and PM peak hours are illustrated in **Figure 2A**.

BACKGROUND DEVELOPMENT TRAFFIC VOLUMES

The City of Ann Arbor provided information for two (2) new developments, Traverwood Apartments and Woodbury Club Apartments, which might influence the background traffic on Nixon Road and Plymouth Road. The Traverwood Apartments development will be located on the west side of Traverwood Road, between Huron Parkway and Plymouth Road, which is approximately one-quarter mile west of Nixon Road. The Woodbury Club Apartments development will be located in the southeast corner of Nixon Road and M-14/US-23, and directly across from the proposed Nixon Property Condominiums development.

Using the traffic impact study developed by Midwestern Consulting, LLC in May, 2013, and the traffic impact study also developed by Midwestern Consulting, LLC in August, 2013, the new site generated traffic from the proposed Traverwood Apartments and the Woodbury Club Apartments development were used as background development traffic. Traffic was distributed based on existing traffic volume patterns. Background development traffic volumes during the AM and PM peak hours are illustrated in **Figure 2B**.

The total background traffic volumes during the AM and PM peak hours, background growth and background development, are illustrated in **Figure 2C**.



Nixon Road Development

Nixon Road Development

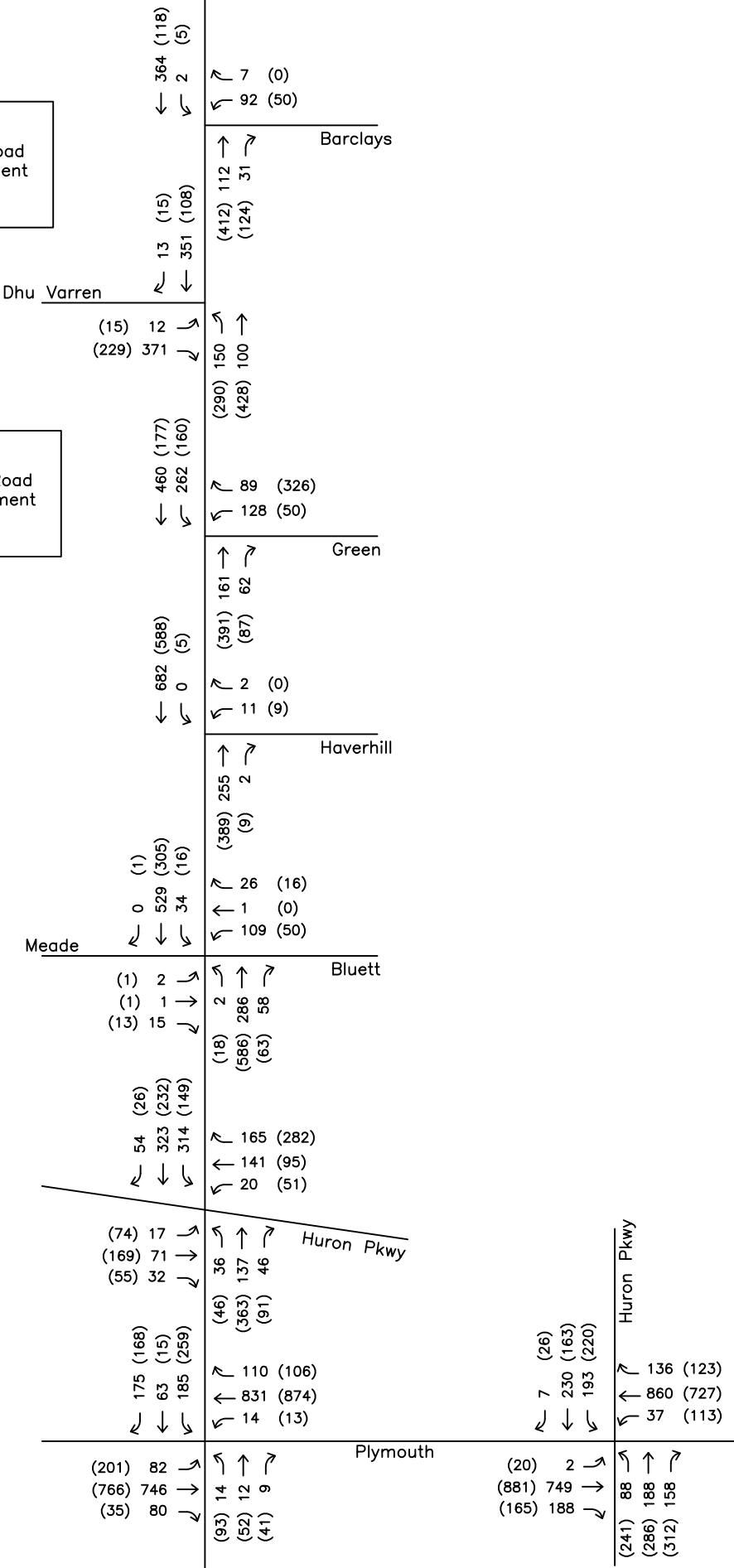

 <p>TRAFFIC ENGINEERING ASSOCIATES, INC. PO Box 10681 Sarasota, MI 48881 PHONE: (517) 627-6028</p>	<p>LEGEND</p> <p>XXX AM Pk Hr (8:00-9:00 AM) Volumes</p> <p>(XXX) PM Pk Hr (5:00-6:00 PM) Volumes</p>		<p>FIGURE 2A: Background Growth Traffic - Peak Hours</p>	
	<p>DATE: November, 2014</p>	<p>SCALE: NTS</p>	<p>PAGE: 16</p>	

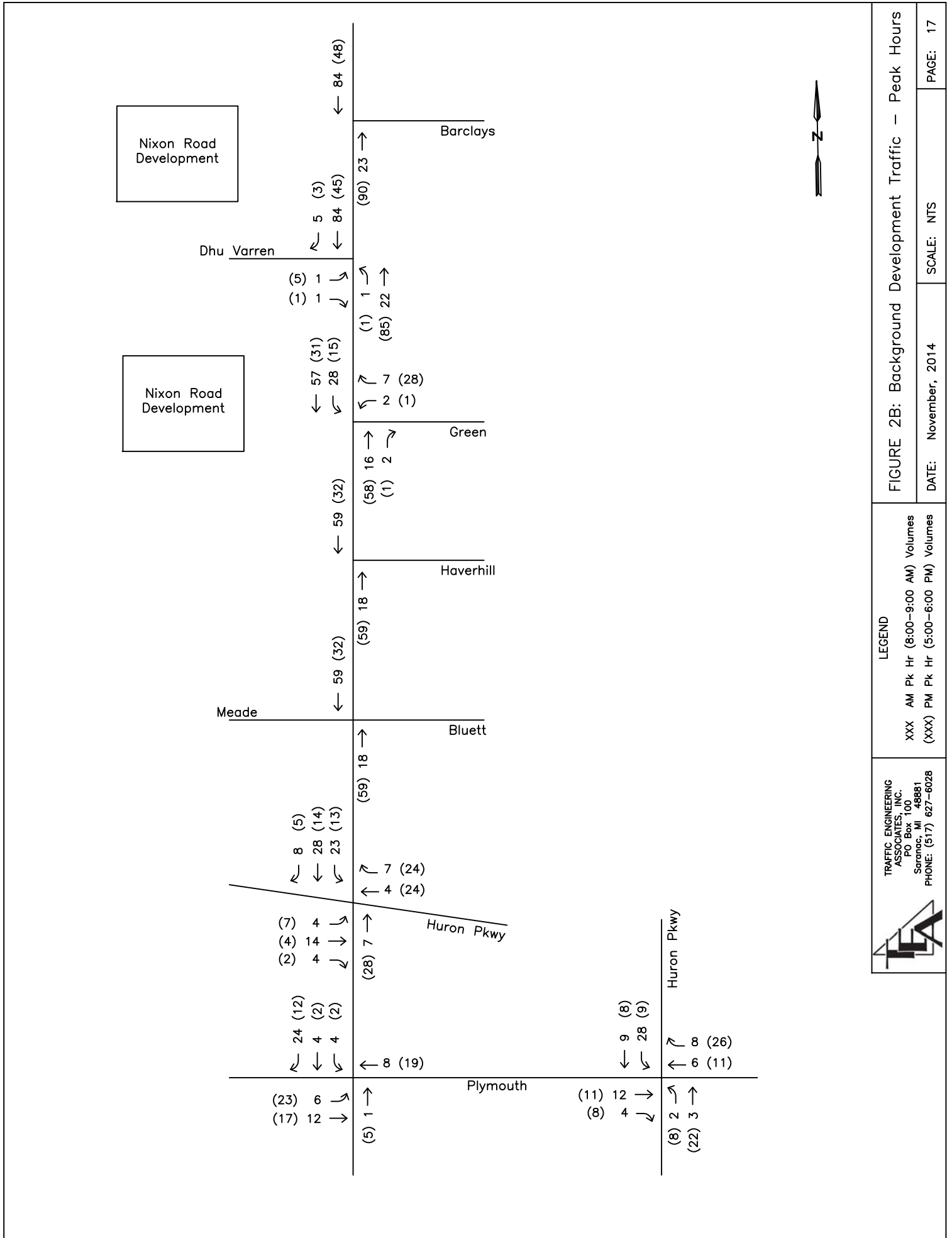

Nixon Road Development

Nixon Road Development

Dhu Varren

Meade

Barclays

Green

Haverhill

Bluett

Huron Pkwy

Plymouth

Huron Pkwy

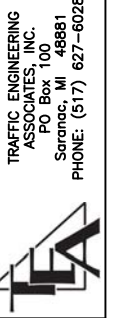
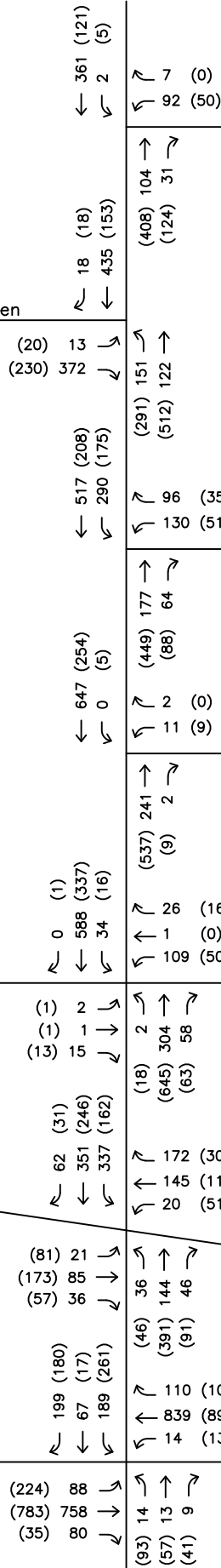

TRAFFIC ENGINEERING ASSOCIATES, INC.
PO Box 10881
Sarasota, MI 48881
PHONE: (517) 627-6028

LEGEND
XXX AM Pk Hr (8:00-9:00 AM) Volumes
(XXX) PM Pk Hr (5:00-6:00 PM) Volumes

FIGURE 2C: Total Background Traffic - Peak Hours

DATE: November, 2014

SCALE: NTS

PAGE: 18

LEVEL OF SERVICE ANALYSIS FOR BACKGROUND TRAFFIC

For background traffic conditions, all existing geometrics and traffic control were used. The level of service analysis for background traffic at the subject intersections during the AM and PM peak hours is summarized in **Table 2**.

All background turning movements at the studied intersections are anticipated to operate at an acceptable level of service (LOS D or better) during the AM and PM peak hours except for the following movements;

- Nixon Road and Dhu Varren Road, the southbound thru-right traffic during the AM peak hour is expected to operate at a LOS E with a vehicle delay of 36.3 seconds, an increase from existing conditions of 19.5 seconds.
- Nixon Road and Green Road, the southbound thru-left traffic during the AM peak hour is anticipated to operate at a LOS F with a vehicle delay of 218.7 seconds, and increase from existing conditions of 113.2 seconds.
- Nixon Road and Meade Court/Bluett Drive westbound left-thru-right traffic during the AM peak hour is expected to operate at a LOS F with a vehicle delay of 334.6 seconds, an increase from existing conditions of 191.1 seconds.
- Nixon Road and Huron Parkway (roundabout), the southbound traffic during the AM peak hour is anticipated to operate at a LOS E with a vehicle delay of 71.0 seconds, and increase from existing conditions of 38.5 seconds.
- Nixon Road and Plymouth Road eastbound left turning traffic during the AM peak hour is expected to operate at a LOS E with a vehicle delay of 63.0 seconds, an increase from existing conditions of 0.3 seconds.
- Nixon Road and Plymouth Road westbound left turning traffic during the AM peak hour is anticipated to operate at a LOS E with a vehicle delay of 78.8 seconds.
- Nixon Road and Plymouth Road northbound left turning traffic during the AM peak hour is expected to operate at a LOS E with a vehicle delay of 58.2 seconds, an increase from existing conditions of 0.2 seconds.
- Nixon Road and Plymouth Road southbound left turning traffic during the AM peak hour is anticipated to operate at a LOS F with a vehicle delay of 113.3 seconds, an increase from existing conditions of 3.0 seconds.
- Huron Parkway and Plymouth Road westbound left turning traffic during the AM peak hour is expected to operate at a LOS E with a vehicle delay of 60.2 seconds, an increase from existing conditions of 0.2 seconds.



- Huron Parkway and Plymouth Road northbound left turning traffic during the AM peak hour is anticipated to operate at a LOS E with a vehicle delay of 62.8 seconds, an increase from existing conditions of 0.2 seconds.
- Huron Parkway and Plymouth Road southbound left turning traffic during the AM peak hour is expected to operate at a LOS F with a vehicle delay of 143.5 seconds, an increase from existing conditions of 50.8 seconds.
- Nixon Road and Dhu Varren Road, the northbound left-thru traffic during the PM peak hour is anticipated to operate at a LOS F with a vehicle delay of 169.4 seconds, an increase from existing conditions of 105.5 seconds.
- Nixon Road and Green Road, the northbound thru-right traffic during the PM peak hour is expected to operate at a LOS E with a vehicle delay of 65.6 seconds, an increase from existing conditions of 41.1 seconds.
- Nixon Road and Meade Court/Bluett Drive, the westbound left-thru-left traffic during the PM peak hour is anticipated to operate at a LOS E with a vehicle delay of 40.5 seconds, an increase from existing conditions of 12.9 seconds.
- Nixon Road and Huron Parkway (roundabout), the westbound traffic during the PM peak hour is expected to operate at a LOS F with a vehicle delay of 50.7 seconds, an increase from existing conditions of 27.4 seconds.
- Nixon Road and Huron Parkway (roundabout), the northbound traffic during the PM peak hour is anticipated to operate at a LOS E with a vehicle delay of 39.5 seconds, an increase from existing conditions of 16.8 seconds.
- Nixon Road and Plymouth Road eastbound left turning traffic during the PM peak hour is expected to operate at a LOS E with a vehicle delay of 55.8 seconds.
- Nixon Road and Plymouth Road westbound left turning traffic during the PM peak hour is anticipated to operate at a LOS E with a vehicle delay of 61.8 seconds.
- Nixon Road and Plymouth Road northbound left turning traffic during the PM peak hour is expected to operate at a LOS E with a vehicle delay of 66.8 seconds.
- Nixon Road and Plymouth Road southbound left turning traffic during the PM peak hour is anticipated to operate at a LOS F with a vehicle delay of 205.3 seconds, an increase from existing conditions of 34.0 seconds.
- Huron Parkway and Plymouth Road eastbound left turning traffic during the PM peak hour is expected to operate at a LOS E with a vehicle delay of 58.1 seconds.
- Huron Parkway and Plymouth Road westbound left turning traffic during the PM peak hour is anticipated to operate at a LOS E with a vehicle delay of 63.6 seconds.



- Huron Parkway and Plymouth Road northbound left turning traffic during the PM peak hour is anticipated to operate at a LOS E with a vehicle delay of 74.8 seconds, an increase from existing conditions of 4.5 seconds.
- Huron Parkway and Plymouth Road northbound thru traffic during the PM peak hour is expected to operate at a LOS E with a vehicle delay of 56.6 seconds.
- Huron Parkway and Plymouth Road southbound left turning traffic during the PM peak hour is anticipated to operate at a LOS F with a vehicle delay of 83.0 seconds, an increase from existing conditions of 7.8 seconds.



Table 2
Level of Service (LOS) Summary
Background AM and PM Peak Hour Traffic

Location	Movement	Weekday AM Peak Hour		Weekday PM Peak Hour	
		Avg. Delay	LOS	Avg. Delay	LOS
Nixon Road and Dhu Varren Road	EB Left-Thru-Right	21.4	C	13.9	B
	NB Left-Thru	28.1	D	<u>169.4</u>	<u>F</u>
	SB Thru-Right	<u>36.3</u>	<u>E</u>	12.2	B
Nixon Road and Green Road	WB Left	21.7	B	10.7	C
	WB Right	10.3	B	23.3	C
	NB Thru-Right	17.8	C	<u>65.6</u>	<u>F</u>
	SB Thru-Left	<u>218.7</u>	<u>F</u>	26.5	D
Nixon Road and Meade Court/Bluett Drive	EB Left-Thru-Right	17.5	C	13.0	B
	WB Left-Thru-Right	<u>334.6</u>	<u>F</u>	<u>40.5</u>	<u>E</u>
	NB Left-Thru-Right	0.1	A	0.4	A
	SB Left	0.5	A	9.2	A
	SB Thru-Right	0.0	A	0.0	A
Nixon Road and Huron Parkway (Roundabout)	EB	15.0	B	18.2	C
	WB	10.0	A	<u>50.7</u>	<u>F</u>
	NB	11.6	B	<u>39.5</u>	<u>E</u>
	SB	<u>71.0</u>	<u>F</u>	14.5	B
	Intersection	24.9	C	32.2	D
Nixon Road and Plymouth Road	EB Left	<u>63.0</u>	<u>E</u>	<u>55.8</u>	<u>E</u>
	EB Thru-Right	17.0	B	17.0	B
	WB Left	<u>78.8</u>	<u>E</u>	<u>61.8</u>	<u>E</u>
	WB Thru-Right	13.6	B	30.2	C
	NB Left	<u>58.2</u>	<u>E</u>	<u>66.8</u>	<u>E</u>
	NB Thru-Right	32.5	C	53.1	D
	SB Left	<u>113.3</u>	<u>F</u>	<u>205.3</u>	<u>F</u>
	SB Thru-Right	46.0	D	15.6	B
	Intersection	30.5	C	46.5	D



Table 2
Level of Service (LOS) Summary
Background AM and PM Peak Hour Traffic (continued)

Location	Movement	Weekday AM Peak Hour		Weekday PM Peak Hour	
		Avg. Delay	LOS	Avg. Delay	LOS
Huron Parkway and Plymouth Road	EB Left	45.0	D	<u>58.1</u>	<u>E</u>
	EB Thru-Right	25.7	C	37.3	D
	WB Left	<u>60.2</u>	<u>E</u>	<u>63.6</u>	<u>E</u>
	WB Thru-Right	18.5	B	<u>27.3</u>	<u>C</u>
	NB Left	<u>62.8</u>	<u>E</u>	<u>74.8</u>	<u>E</u>
	NB Thru	53.9	D	<u>56.6</u>	<u>E</u>
	NB Right	19.2	B	29.2	C
	SB Left	<u>143.5</u>	<u>F</u>	<u>83.0</u>	<u>F</u>
	SB Thru-Right	52.4	D	49.8	D
	Intersection	37.9	D	43.2	D
Nixon Road and Barclays Way	WB Left-Right	15.0	B	15.9	C
	NB Thru-Right	0.0	A	0.0	A
	SB Thru-Left	0.1	A	0.4	A
	Intersection	2.7	A	1.7	A
Nixon Road and Haverhill Court	WB Left-Right	19.6	C	16.4	C
	NB Thru-Right	0.0	A	0.0	A
	SB Thru-Left	0.0	A	0.2	A
	Intersection	0.4	A	0.4	A

Note: Delay = Average control delay per vehicle in seconds.
LOS = Level of Service



LEVEL OF SERVICE ANALYSIS FOR MITIGATED BACKGROUND TRAFFIC

As part of the new site plan for the Nixon Property Condominiums development, the intersection of Dhu Varren Road and Green Road will be aligned to eliminate the existing 90 foot offset between these two intersections. It should be noted that due to the large offset between these intersections, the Synchro model evaluated these as two (2) separate intersections, even though there is an existing 4-way stop control. When the two (2) intersections are aligned the vehicle delay and level of service decreases which more accurately reflects the actual traffic flow at this location, rather than the two separate intersections in the existing traffic Synchro model. An analysis for a modern roundabout and a traffic signal warrant analysis were conducted as part of this study.

At the Nixon Road and Meade Court/Bluett Drive intersection, which is currently a 2-way stop control, the level of service “F” for westbound traffic is due to a combination of the large amount of AM peak hour southbound commuter traffic on Nixon Road and the large amount of AM peak hour westbound left turning traffic from Bluett Drive. An analysis was made for this intersection with a 4-way stop control configuration. The decision to install a 4-way stop at this intersection will need to be evaluated as the multi-way stop will decrease the long vehicle delays for the westbound traffic on Bluett Drive, but it will increase the vehicle delays for both northbound and southbound Nixon Road.

The two (2) signalized intersections, Nixon Road at Plymouth Road and Huron Parkway at Plymouth Road, experience lengthy delays at all of the left turn movements. This is due to a combination of the coordinated system along Plymouth Road and the existing leading left turn phase at both intersections. If a permissive/protected, lagging left turn phase could be installed and still maintain the coordination, both intersections would see an improvement in the level of service and a decrease in vehicle delay for the left turn movements.

The level of service analysis for background mitigated traffic at the subject intersections during the AM and PM peak hours is summarized in **Table 3**.

All background mitigated turning movements at the studied intersections are expected to operate at an acceptable level of service (LOS D or better) during the AM and PM peak hours except for the following movements;

- Nixon Road and Meade Court/Bluett Drive southbound thru-right traffic during the AM peak hour is expected to operate at a LOS F with a vehicle delay of 157.8 seconds.
- Nixon Road and Meade Court/Bluett Drive northbound left-thru-right traffic during the PM peak hour is anticipated to operate at a LOS F with a vehicle delay of 60.8 seconds.
- Nixon Road and Plymouth Road southbound left turning traffic during the PM peak hour is expected to operate at a LOS E with a vehicle delay of 70.3 seconds, a decrease from background conditions of 135.0 seconds.



- Huron Parkway and Plymouth Road northbound thru traffic during the AM peak hour is anticipated to operate at a LOS E with a vehicle delay of 56.8 seconds, an increase from background conditions of 2.9 seconds.
- Huron Parkway and Plymouth Road southbound left turning traffic during the AM peak hour is expected to operate at a LOS E with a vehicle delay of 64.1 seconds, a decrease from background conditions of 79.4 seconds.
- Huron Parkway and Plymouth Road southbound thru-right turning traffic during the AM peak hour is anticipated to operate at a LOS E with a vehicle delay of 56.5 seconds, an increase from background conditions of 4.1 seconds.
- Huron Parkway and Plymouth Road northbound thru traffic during the PM peak hour is expected to operate at a LOS E with a vehicle delay of 56.7 seconds, same as background conditions.
- Huron Parkway and Plymouth Road southbound left turning traffic during the PM peak hour is anticipated to operate at a LOS E with a vehicle delay of 73.1 seconds, a decrease from background conditions of 9.9 seconds.
- Huron Parkway and Plymouth Road southbound thru-right turning traffic during the PM peak hour is expected to operate at a LOS E with a vehicle delay of 55.1 seconds.

All other left turning movements decrease the vehicle delay and increase the level of service to a LOS D or better.



Table 3
Level of Service (LOS) Summary
Background Mitigated AM and PM Peak Hour Traffic

Location	Movement	Weekday AM Peak Hour		Weekday PM Peak Hour	
		Avg. Delay	LOS	Avg. Delay	LOS
Nixon Road and Meade Court/Bluett Drive	EB Left-Thru-Right	10.6	B	9.6	A
	WB Left-Thru-Right	15.6	C	10.9	B
	NB Left-Thru-Right	26.8	D	<u>60.8</u>	<u>F</u>
	SB Left	9.2	A	14.9	B
	SB Thru-Right	<u>157.8</u>	<u>F</u>	15.2	B
Nixon Road and Plymouth Road	EB Left	17.2	B	47.8	D
	EB Thru-Right	16.0	B	18.1	B
	WB Left	12.2	B	6.4	A
	WB Thru-Right	19.4	B	19.1	B
	NB Left	33.9	C	41.1	D
	NB Thru-Right	42.7	D	53.5	D
	SB Left	48.3	D	<u>70.3</u>	<u>E</u>
	SB Thru-Right	46.0	D	19.3	B
Intersection	24.5	C	28.3	C	
Huron Parkway and Plymouth Road	EB Left	7.0	A	8.5	A
	EB Thru-Right	21.1	C	24.2	C
	WB Left	12.4	B	35.9	D
	WB Thru-Right	15.5	B	21.6	C
	NB Left	47.0	D	45.0	D
	NB Thru	<u>56.8</u>	<u>E</u>	<u>56.7</u>	<u>E</u>
	NB Right	13.7	B	31.4	C
	SB Left	<u>64.1</u>	<u>E</u>	<u>73.1</u>	<u>E</u>
	SB Thru-Right	<u>56.5</u>	<u>E</u>	<u>55.1</u>	<u>E</u>
	Intersection	28.1	C	34.1	C

Note: Delay = Average control delay per vehicle in seconds.
LOS = Level of Service



FUTURE CONDITIONS



SITE TRAFFIC GENERATION

The trip generation rates for the Nixon Property Condominiums development were derived from the ITE TRIP GENERATION MANUAL (9th edition). The ITE trip generation rates for Luxury Condominium/ Townhouse (Land Use Code 233) were selected as representing the proposed 473 Units. The ITE description of Luxury Condominium/ Townhouse is as follows:

Luxury condominiums/ townhouses are units in buildings with luxury facilities or services. Both condominiums and townhouses are included in this land use.

The Luxury Condominium/ Townhouse category does not provide a weekday total for trip generation; therefore, Residential Condominium/ Townhouse (Land Use Code 230) was utilized for the weekday trip generation estimate. The ITE description of Residential Condominium/ Townhouse is as follows:

Residential condominiums/ townhouses are defined as ownership units that have at least one other owned unit within the same building structure. Both condominiums and townhouses are included in this land use. The studies in this land use did not identify whether the condominiums/ townhouses were low-rise or high-rise.

It is projected that the proposed Nixon Property Condominiums development will generate 265 vehicle trips in the AM peak hour, 260 vehicle trips in the PM peak hour and 2,486 vehicle trips daily. The projected traffic to be generated by the proposed development is summarized in **Table 4**.



Table 4
Vehicle Trip Generation Summary
Proposed Nixon Property Condominiums Development

Land Use	Size	AM Peak Hour			PM Peak Hour			Weekday
		In	Out	Total	In	Out	Total	Total
Luxury Condominium/ Townhouse; Code 233	473 Units	61	204	265	164	96	260	--
Residential Condominium/ Townhouse; Code 230	473 Units	--	--	--	--	--	--	2,486
Total Trips		61	204	265	164	96	260	2,486



SITE TRAFFIC DISTRIBUTION

Traffic distribution for the Nixon Property Condominiums development was based on existing traffic patterns on the surrounding roadways within the study area. Typically, a residential facility has a traffic pattern where vehicles are exiting in the morning and entering in the evening; therefore, the existing exiting traffic pattern on the roadway system during the morning and the entering traffic pattern during the evening generated the distribution for this study. The distribution for the residential generated traffic is as follows.

Residential Trip Distribution

Direction of Approach and Departure	AM Peak Hour	PM Peak Hour
To/From the NORTH on Nixon Road	3%	3%
To/From the SOUTH on Nixon Road	5%	5%
To/From the WEST on Dhu Varren Road	5%	5%
To/From the EAST on Green Road	10%	10%
To/From the WEST on Meade Court	0%	0%
To/From the EAST on Bluett Drive	2%	2%
To/From the WEST on Huron Parkway	5%	5%
To/From the WEST on Plymouth Road	30%	25%
To/From the EAST on Plymouth Road	30%	25%
To/From the SOUTH on Huron Parkway	10%	20%

Traffic was then further distributed by driveway. Based on the site plan, it was estimated that approximately one third (1/3) of the traffic would use the north proposed driveway on Nixon Road, one third (1/3) would use the south proposed driveway on Nixon Road, and the remaining one third (1/3) would be split between the two (2) proposed driveways on Dhu Varren Road. Any traffic to and from the west on Dhu Varren Road was distributed to the proposed driveway on Dhu Varren Road. All newly generated traffic on Dhu Varren Road was split evenly between the two proposed driveways on Dhu Varren Road.

The total estimated site generated traffic for the proposed Nixon Property Condominiums development during the AM and PM peak hours is illustrated in **Figure 3**.

Adding the total site generated traffic (Figure 3) to the total background traffic volumes (Figure 2C) results in the total future traffic volumes for the weekday AM and PM peak hours, which are illustrated in **Figure 4**.



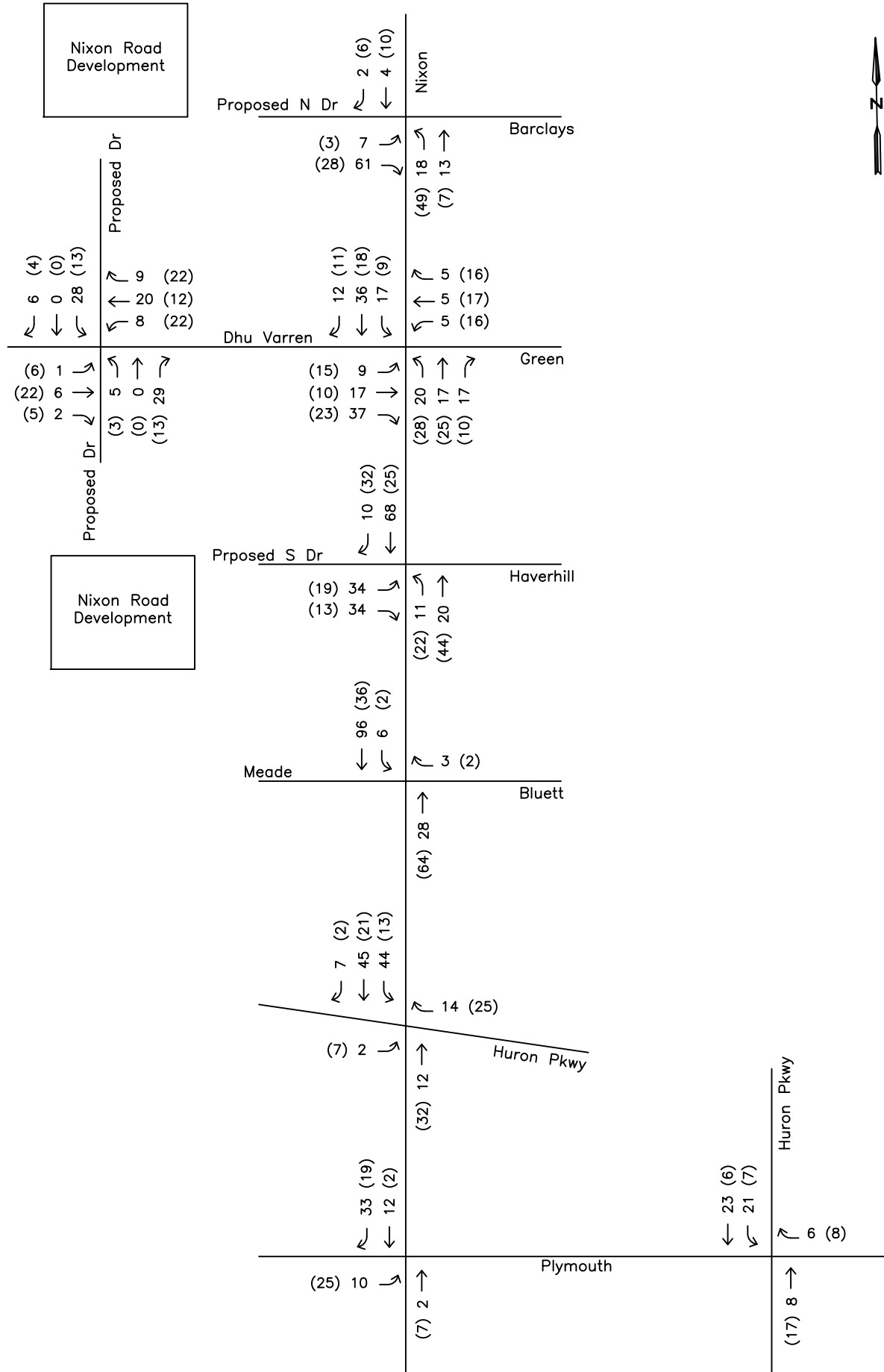

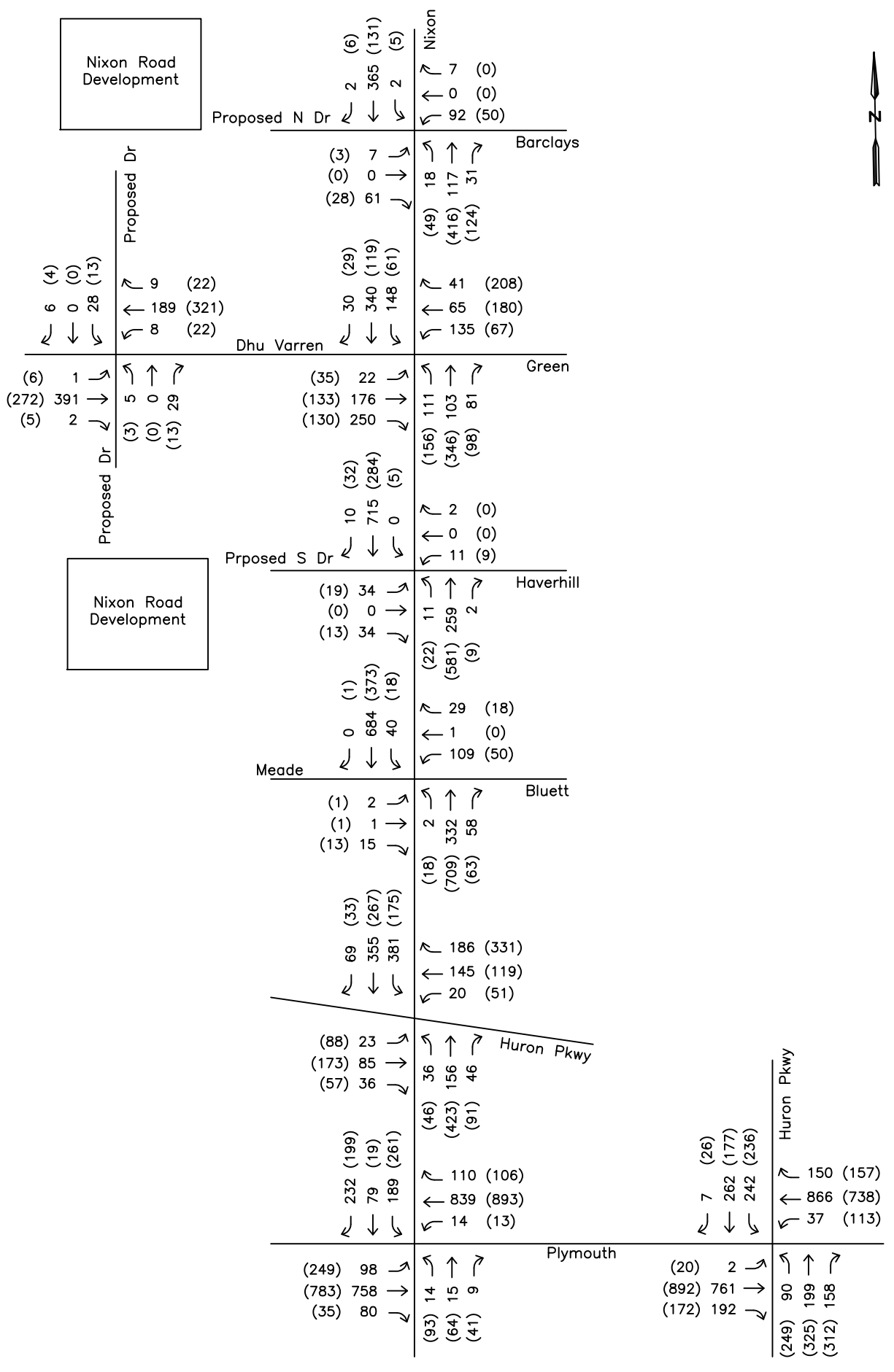

LEVEL OF SERVICE ANALYSIS FOR FUTURE TRAFFIC

The level of service analysis for future AM and PM peak hour traffic is summarized in **Table 5**. For future traffic conditions, all existing geometrics and traffic control were used, with the exception of one location. The intersection of Nixon Road and Dhu Varren/Green Road was aligned so that Dhu Varren Road and Green Road were directly opposite each other, with an eastbound center left turn lane added to Dhu Varren Road to match the existing westbound center left turn lane on Green Road, per the proposed site plans. The proposed four (4) site driveways were modeled as one (1) entering lane and one (1) exiting lane.

All future turning movements at the studied intersections are expected to operate at an acceptable level of service (LOS D or better) during the AM and PM peak hours except for the following movements;

- Nixon Road and Dhu Varren Road/Green Road, the eastbound left turning traffic during the AM peak hour is expected to operate at a LOS F with a vehicle delay of 262.7 seconds.
- Nixon Road and Dhu Varren Road/Green Road, the eastbound thru-right traffic during the AM peak hour is anticipated to operate at a LOS F with a vehicle delay of 573.4 seconds.
- Nixon Road and Dhu Varren Road/Green Road, the westbound left turning traffic during the AM peak hour is expected to operate at a LOS F with such a long delay the software reports an error in the vehicle delay.
- Nixon Road and Dhu Varren Road/Green Road, the westbound thru-right traffic during the AM peak hour is anticipated to operate at a LOS F with a vehicle delay of 89.0 seconds.
- Nixon Road and Meade Court/Bluett Drive westbound left-thru-right traffic during the AM peak hour is expected to operate at a LOS F with a vehicle delay of 571.4 seconds, an increase from background conditions of 236.4 seconds.
- Nixon Road and Huron Parkway (roundabout), the southbound traffic during the AM peak hour is anticipated to operate at a LOS F with a vehicle delay of 98.3 seconds, and increase from background conditions of 27.3 seconds.
- Nixon Road and Plymouth Road eastbound left turning traffic during the AM peak hour is expected to operate at a LOS E with a vehicle delay of 63.3 seconds, an increase from background conditions of 0.3 seconds.
- Nixon Road and Plymouth Road westbound left turning traffic during the AM peak hour is anticipated to operate at a LOS E with a vehicle delay of 79.1 seconds.



- Nixon Road and Plymouth Road northbound left turning traffic during the AM peak hour is expected to operate at a LOS E with a vehicle delay of 58.2 seconds.
- Nixon Road and Plymouth Road southbound left turning traffic during the AM peak hour is anticipated to operate at a LOS E with a vehicle delay of 66.9 seconds.
- Huron Parkway and Plymouth Road westbound left turning traffic during the AM peak hour is expected to operate at a LOS E with a vehicle delay of 60.2 seconds, same as background conditions.
- Huron Parkway and Plymouth Road northbound left turning traffic during the AM peak hour is anticipated to operate at a LOS E with a vehicle delay of 62.8 seconds, same as background conditions.
- Huron Parkway and Plymouth Road southbound left turning traffic during the AM peak hour is expected to operate at a LOS F with a vehicle delay of 178.9 seconds, an increase from existing of 35.4 seconds.
- Nixon Road and Dhu Varren Road/Green Road, the eastbound left turning traffic during the PM peak hour is anticipated to operate at a LOS F with such a long delay the software reports an error in the vehicle delay.
- Nixon Road and Dhu Varren Road/Green Road, the eastbound thru-right traffic during the PM peak hour is expected to operate at a LOS F with a vehicle delay of 119.9 seconds.
- Nixon Road and Dhu Varren Road/Green Road, the westbound left turning traffic during the PM peak hour is anticipated to operate at a LOS F with such a long delay the software reports an error in the vehicle delay.
- Nixon Road and Dhu Varren Road/Green Road, the westbound thru-right traffic during the PM peak hour is expected to operate at a LOS F with a vehicle delay of 249.8 seconds.
- Nixon Road and Meade Court/Bluett Drive westbound left-thru-right traffic during the PM peak hour is anticipated to operate at a LOS F with a vehicle delay of 53.6 seconds, an increase from background conditions of 13.1 seconds.
- Nixon Road and Huron Parkway (roundabout), the westbound traffic during the PM peak hour is expected to operate at a LOS F with a vehicle delay of 75.6 seconds, an increase from background conditions of 24.9 seconds.
- Nixon Road and Huron Parkway (roundabout), the northbound traffic during the PM peak hour is anticipated to operate at a LOS F with a vehicle delay of 54.3 seconds, an increase from background conditions of 14.8 seconds.



- Nixon Road and Plymouth Road eastbound left turning traffic during the PM peak hour is expected to operate at a LOS E with a vehicle delay of 62.7 seconds, an increase from background conditions of 6.9 seconds.
- Nixon Road and Plymouth Road westbound left turning traffic during the PM peak hour is anticipated to operate at a LOS E with a vehicle delay of 61.9 seconds.
- Nixon Road and Plymouth Road northbound left turning traffic during the PM peak hour is expected to operate at a LOS E with a vehicle delay of 66.8 seconds.
- Nixon Road and Plymouth Road northbound thru-right traffic during the PM peak hour is anticipated to operate at a LOS E with a vehicle delay of 55.0 seconds.
- Nixon Road and Plymouth Road southbound left turning traffic during the PM peak hour is expected to operate at a LOS F with a vehicle delay of 205.3 seconds.
- Huron Parkway and Plymouth Road eastbound left turning traffic during the PM peak hour is anticipated to operate at a LOS E with a vehicle delay of 58.4 seconds.
- Huron Parkway and Plymouth Road westbound left turning traffic during the PM peak hour is expected to operate at a LOS E with a vehicle delay of 63.6 seconds.
- Huron Parkway and Plymouth Road northbound left turning traffic during the PM peak hour is anticipated to operate at a LOS E with a vehicle delay of 74.8 seconds.
- Huron Parkway and Plymouth Road northbound thru traffic during the PM peak hour is expected to operate at a LOS E with a vehicle delay of 56.5 seconds.
- Huron Parkway and Plymouth Road southbound left turning traffic during the PM peak hour is anticipated to operate at a LOS F with a vehicle delay of 85.8 seconds, an increase from background of 2.8 seconds.



Table 5
Level of Service (LOS) Summary
Future AM and PM Peak Hour Traffic

Location	Movement	Weekday AM Peak Hour		Weekday PM Peak Hour	
		Avg. Delay	LOS	Avg. Delay	LOS
Nixon Road and Dhu Varren Road/Green Road	EB Left	<u>262.7</u>	F	<u>Err</u>	F
	EB Thru-Right	<u>573.4</u>	F	<u>119.9</u>	F
	WB Left	<u>Err</u>	F	<u>Err</u>	F
	WB Thru-Right	<u>89.0</u>	F	<u>249.8</u>	F
	NB Left-Thru-Right	4.4	A	3.0	A
	SB Left-Thru-Right	3.4	A	2.9	A
	Intersection	<u>Err</u>	F	<u>Err</u>	F
Nixon Road and Meade Court/Bluett Drive	EB Left-Thru-Right	20.8	C	13.9	B
	WB Left-Thru-Right	<u>571.4</u>	F	<u>53.6</u>	F
	NB Left-Thru-Right	0.1	A	0.4	A
	SB Left	8.6	A	9.4	A
	SB Thru-Right	0.0	A	0.0	A
	Intersection	<u>84.5</u>	F	4.1	A
Nixon Road and Huron Parkway (Roundabout)	EB	16.7	C	20.6	C
	WB	10.7	B	<u>75.6</u>	F
	NB	13.2	B	<u>54.3</u>	F
	SB	<u>98.3</u>	F	16.4	C
	Intersection	<u>58.6</u>	F	<u>44.1</u>	E
Nixon Road and Plymouth Road	EB Left	<u>63.3</u>	E	<u>62.7</u>	E
	EB Thru-Right	19.3	B	17.5	B
	WB Left	<u>79.1</u>	E	<u>61.9</u>	E
	WB Thru-Right	17.4	B	30.3	C
	NB Left	<u>58.2</u>	E	<u>66.8</u>	E
	NB Thru-Right	33.0	C	<u>55.0</u>	E
	SB Left	<u>66.9</u>	E	<u>205.3</u>	F
	SB Thru-Right	44.4	D	15.3	B
Intersection	28.8	C	47.3	D	



Table 5
Level of Service (LOS) Summary
Future AM and PM Peak Hour Traffic (continued)

Location	Movement	Weekday AM Peak Hour		Weekday PM Peak Hour	
		Avg. Delay	LOS	Avg. Delay	LOS
Huron Parkway and Plymouth Road	EB Left	45.5	D	<u>58.4</u>	<u>E</u>
	EB Thru-Right	25.5	C	39.0	D
	WB Left	<u>60.2</u>	<u>E</u>	<u>63.6</u>	<u>E</u>
	WB Thru-Right	19.1	B	28.0	C
	NB Left	<u>62.8</u>	<u>E</u>	<u>74.8</u>	<u>E</u>
	NB Thru	53.2	D	<u>56.5</u>	<u>E</u>
	NB Right	18.8	B	28.6	C
	SB Left	<u>178.9</u>	<u>F</u>	<u>85.8</u>	<u>F</u>
	SB Thru-Right	<u>52.7</u>	D	48.7	D
	Intersection	42.0	D	44.1	D
Dhu Varren Road and Site Driveway	EB Left-Thru-Right	0.0	A	0.2	A
	WB Left-Thru-Right	0.4	A	0.7	A
	NB Left-Thru-Right	11.6	B	11.5	B
	SB Left-Thru-Right	15.1	C	15.9	C
	Intersection	1.5	A	1.1	A
Nixon Road and North Site Driveway/Barclays Way	EB Left-Thru-Right	12.0	B	10.1	A
	WB Left-Thru-Right	23.1	C	24.9	C
	NB Left-Thru-Right	1.2	A	1.1	A
	SB Left-Thru-Right	0.1	A	0.4	A
	Intersection	4.4	A	3.4	A
Nixon Road and South Site Driveway/Haverhill Court	EB Left-Thru-Right	31.2	D	18.8	C
	WB Left-Thru-Right	33.2	D	23.7	C
	NB Left-Thru-Right	0.7	A	0.5	A
	SB Left-Thru-Right	0.0	A	0.2	A
	Intersection	2.3	A	1.2	A

Note: Delay = Average control delay per vehicle in seconds.

LOS = Level of Service



FUTURE MITIGATED CONDITIONS



LEVEL OF SERVICE ANALYSIS FOR FUTURE MITIGATED TRAFFIC

The level of service analysis for future mitigated traffic is summarized in **Table 6**. Comparing future mitigated level of service conditions to background mitigated level of service conditions determines the impact that can be expected from the addition of traffic generated from the Nixon Property Condominium development, with changes to the roadway geometrics and traffic control devices to mitigate vehicle delay. All existing geometrics and traffic control were utilized for the future mitigated conditions except for the following changes;

- The intersection of Nixon Road and Dhu Varren/Green Road was aligned so that Dhu Varren Road and Green Road were directly opposite each other, with a center left turn lane added to Dhu Varren Road to match the existing center left turn lane on Green Road. This intersection was evaluated with five (5) different traffic control scenarios, and a separate comparison was made, see Table 7 in the Road Improvement Considerations section. For the future mitigated evaluation of this intersection, a two-phase traffic signal design was used.
- New center left turn lanes were added to northbound and southbound Nixon Road at the new aligned Dhu Varren Road and Green Road intersection. The center left turn lanes were added based on the MDOT left turn lane guidelines.
- New exclusive right turn lanes were added to northbound Nixon Road, eastbound Dhu Varren Road and westbound Green Road based on the MDOT right turn lane guidelines.
- Changed the stop control at the intersection of Nixon Road and Meade Court/Bluett Drive from the existing 2-way to a 4-way stop control.
- New northbound center left turn lanes were added on Nixon Road at both of the proposed site driveways.
- Changed the traffic signal phasing at the intersections of Nixon Road at Plymouth Road and Huron Parkway at Plymouth Road from the existing protected leading left turns to permissive/protected lagging left turns for all four (4) approaches.

Under future mitigated conditions it is anticipated that all movements will operate at an acceptable level of service, LOS D or better, except for the following movements;

- Nixon Road and Meade Court/Bluett Drive southbound thru-right movement is expected to operate at a LOS F during the AM peak hour with 62.7 seconds of vehicle delay.
- Nixon Road and Meade Court/Bluett Drive northbound left-thru-right movement is anticipated to operate at a LOS F during the PM peak hour with 55.4 seconds of vehicle delay.



- Nixon Road and Plymouth Road northbound thru-right traffic during the PM peak hour is expected to operate at a LOS E with a vehicle delay of 55.2 seconds.
- Nixon Road and Plymouth Road southbound left turning traffic during the PM peak hour is expected to operate at a LOS F with a vehicle delay of 84.6 seconds.
- Huron Parkway and Plymouth Road northbound thru traffic during the PM peak hour is anticipated to operate at a LOS E with a vehicle delay of 55.2 seconds.

Under future mitigated conditions it is anticipated that the following movements will be improved to a better level of service with a significant decrease in the vehicle delay from future conditions;

- Huron Parkway and Plymouth Road southbound left turning traffic during the AM peak hour is expected to operate at a LOS F with a vehicle delay of 82.9 seconds, a decrease of 120.9 seconds.
- Huron Parkway and Plymouth Road southbound left turning traffic during the PM peak hour is expected to operate at a LOS E with a vehicle delay of 58.0 seconds, a decrease of 35.0 seconds from future conditions.
- Huron Parkway and Plymouth Road westbound left turning traffic during the AM peak hour is expected to operate at a LOS B with a vehicle delay of 12.0 seconds, a decrease of 48.2 seconds from future conditions.
- Huron Parkway and Plymouth Road northbound left turning traffic during the AM peak hour is expected to operate at a LOS D with a vehicle delay of 20.8 seconds, a decrease of 42.0 seconds from future conditions.
- Huron Parkway and Plymouth Road eastbound left turning traffic during the PM peak hour is expected to operate at a LOS B with a vehicle delay of 10.4 seconds, a decrease of 48.0 seconds from future conditions.
- Huron Parkway and Plymouth Road westbound left turning traffic during the PM peak hour is expected to operate at a LOS C with a vehicle delay of 24.6 seconds, a decrease of 39.0 seconds from future conditions.
- Huron Parkway and Plymouth Road northbound left turning traffic during the PM peak hour is expected to operate at a LOS D with a vehicle delay of 41.1 seconds, a decrease of 33.7 seconds from future conditions.
- Huron Parkway and Plymouth Road southbound left turning traffic during the PM peak hour is expected to operate at a LOS D with a vehicle delay of 50.8 seconds, a decrease of 35.0 seconds from future conditions.



- Nixon Road and Plymouth Road eastbound left turning traffic during the PM peak hour is anticipated to operate at a LOS C with a vehicle delay of 31.2 seconds, a decrease of 31.5 seconds.
- Nixon Road and Plymouth Road westbound left turning traffic during the PM peak hour is anticipated to operate at a LOS A with a vehicle delay of 9.7 seconds, a decrease of 52.2 seconds.
- Nixon Road and Plymouth Road northbound left turning traffic during the PM peak hour is anticipated to operate at a LOS D with a vehicle delay of 47.1 seconds, a decrease of 19.7 seconds.
- Nixon Road and Plymouth Road southbound left turning traffic during the PM peak hour is anticipated to operate at a LOS F with a vehicle delay of 84.6 seconds, a decrease of 120.7 seconds.



Table 6
Level of Service (LOS) Summary
Future Mitigated AM and PM Peak Hour Traffic

Location	Movement	Weekday AM Peak Hour		Weekday PM Peak Hour	
		Avg. Delay	LOS	Avg. Delay	LOS
Nixon Road and Dhu Varren Road/Green Road	EB Left	13.9	B	14.3	B
	EB Thru	22.5	C	19.6	C
	EB Right	28.9	D	17.4	C
	WB Left	26.0	D	15.0	B
	WB Thru	16.5	C	21.3	C
	WB Right	14.1	B	21.0	C
	NB Left	23.5	C	19.2	C
	NB Thru	20.6	C	<u>57.6</u>	<u>F</u>
	NB Right	16.5	C	13.4	B
	SB Left	20.8	C	15.3	C
	SB Thru-Right	<u>77.0</u>	<u>F</u>	19.2	C
	Intersection	34.7	D	27.1	D
Nixon Road and Meade Court/Bluett Drive	EB Left-Thru-Right	10.8	B	9.7	A
	WB Left-Thru-Right	16.2	C	11.0	B
	NB Left-Thru-Right	33.5	D	<u>55.4</u>	<u>F</u>
	SB Left	10.3	B	9.0	A
	SB Thru-Right	<u>62.7</u>	<u>F</u>	18.2	C
	Intersection	<u>44.8</u>	<u>E</u>	<u>39.4</u>	<u>E</u>
Nixon Road and Plymouth Road	EB Left	14.6	B	31.2	C
	EB Thru-Right	17.7	B	16.2	B
	WB Left	4.4	A	9.7	A
	WB Thru-Right	12.2	B	22.9	C
	NB Left	33.2	C	47.1	D
	NB Thru-Right	32.9	C	<u>55.2</u>	<u>E</u>
	SB Left	47.0	D	<u>84.6</u>	<u>F</u>
	SB Thru-Right	46.3	D	13.6	B
	Intersection	22.4	C	29.0	C



Table 6
Level of Service (LOS) Summary
Future Mitigated AM and PM Peak Hour Traffic (continued)

Location	Movement	Weekday AM Peak Hour		Weekday PM Peak Hour	
		Avg. Delay	LOS	Avg. Delay	LOS
Huron Parkway and Plymouth Road	EB Left	21.0	C	10.4	B
	EB Thru-Right	27.3	C	28.0	C
	WB Left	12.0	B	24.6	C
	WB Thru-Right	18.1	B	24.0	C
	NB Left	35.9	D	41.1	D
	NB Thru	<u>55.2</u>	<u>E</u>	<u>56.9</u>	<u>E</u>
	NB Right	20.8	C	33.2	C
	SB Left	<u>58.0</u>	<u>E</u>	50.8	D
	SB Thru-Right	52.1	D	48.2	D
	Intersection	30.5	C	33.5	C

Note: Delay = Average control delay per vehicle in seconds.

LOS = Level of Service



SIGNIFICANT FINDINGS

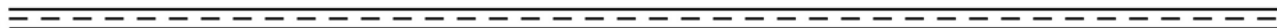

ROAD IMPROVEMENT CONSIDERATIONS

Nixon Road and Dhu Varren/Green Road

The proposed new roadway alignment will eliminate the 90 foot offset between Dhu Varren Road and Green Road, and a new center left turn lane should be added to eastbound Dhu Varren Road to match the existing center left turn lane on Green Road. A review of the MDOT guidelines show that center left turn lanes for northbound and southbound Nixon Road are needed. Also, the MDOT guidelines show that exclusive right turn lanes are needed for the eastbound and westbound approaches, as well as for the northbound approach on Nixon Road.

This intersection was evaluated for traffic control using five (5) different scenarios;

- 2-way stop control
- 4-way stop control
- 1-lane roundabout
- 2-lane roundabout
- Traffic signal

The traffic control with the best level of service and the least amount of vehicle delay was the traffic signal; however, a review of Warrant 3, Peak Hour Warrant, in the Michigan Manual of Traffic Control Devices, shows that the intersection did not meet the warrant requirements using the projected future traffic volumes. **Table 7** compares all five (5) scenarios for AM and PM peak hours.

Nixon Road and Meade Court/Bluett Drive

The existing traffic control for this intersection is a 2-way stop control for eastbound and westbound traffic. Due to the large volume of southbound traffic during the AM peak hour, the westbound left-thru-right traffic experiences a LOS F with 143.5 seconds of vehicle delay under existing conditions; however, under future conditions, and with the 2-way stop control, the westbound left-thru-right movement will experience a LOS F with 571.0 seconds of vehicle delay, an increase of 236.4 seconds from background conditions. Installing a 4-way stop control at this intersection improves the westbound left-thru-right to a LOS C with 16.2 seconds of vehicle delay. However, with the 4-way stop control, the northbound and southbound Nixon Road approaches will also be a LOS F, but with only 62.7 seconds of vehicle delay in the AM peak hour and 55.4 seconds of vehicle delay in the PM peak hour. The vehicle delay experienced by the northbound and southbound traffic on Nixon Road is minor compared to the 571.0 seconds of vehicle delay for westbound Bluett Drive under future conditions without the 4-way stop.

Nixon Road and Plymouth Road

This intersection is controlled by a traffic signal with protected leading green arrows for all four left turn lanes. Under existing conditions, all four left turn movements experience a LOS E or LOS F. By changing the left turn signal to a permissive/protected lagging green arrow phase, under future conditions the level of service improves to LOS D or better in all left turn movements except for the southbound left turn during the PM peak hour, which will maintain



LOS F, but the vehicle delay will decrease. The cycle length remains the same as this signal is on a coordinated system.

Huron Parkway and Plymouth Road

This intersection is controlled by a traffic signal with protected leading green arrows in all four left turn lanes. Under existing conditions, all four left turn movements experience a LOS E or LOS F. By changing the left turn signal to a permissive/protected lagging green arrow phase, the level of service improves to a LOS D or better in all left turn movements, except for the northbound and southbound left turns. During the future AM peak hour and PM peak hours, the northbound and southbound left turn movements will improve to a LOS E. The cycle length remains the same as this signal is on a coordinated system.

Nixon Road and North Site Driveway/Barclays Way

The new site driveway on Nixon Road, north of Dhu Varren Road/Green Road did not meet the MDOT guidelines for a southbound right turn lane; however, it did meet the guidelines for a northbound left turn lane. A northbound and southbound center left turn lane should be constructed on Nixon Road at the north site driveway and Barclays Way intersection.

Nixon Road and South Site Driveway/Haverhill Court

The new site driveway on Nixon Road, south of Dhu Varren Road/Green Road did not meet the MDOT guidelines for a southbound right turn lane; however, it did meet the guidelines for a northbound left turn lane. A northbound and southbound center left turn lane should be constructed on Nixon Road at the south site driveway and Haverhill Court intersection.

Dhu Varren Road and Site Driveways

The two (2) new site driveways located on Dhu Varren Road, west of Nixon Road are designed to be opposite each other. A review of the MDOT guidelines for a right turn lane and a left turn lane was reviewed and this intersection does not meet the criteria for either additional lane. No improvements are needed at this intersection.

Boulevard Site Driveways

A review of the site plan shows that all four (4) site driveways are planned with a boulevard design. Two (2) of the new site driveways located on Dhu Varren Road will be opposite each other, and the two (2) new site driveways located on Nixon Road will be built opposite existing roadways. A boulevard design is not the appropriate roadway layout when the roadways are opposite each other as there will be a left turning conflict. Two vehicles turning left from the opposite boulevards will be forced to turn into each other as the left turn lanes will be offset. Also, the two (2) boulevard site driveways on Nixon Road are opposite roadways that are not boulevards; therefore, it would be difficult to line up the left turn lanes. It is recommended that if the developer would like some type of landscaping or development signing, that an island be constructed back away from the crossroad a sufficient distance to provide for head up center left turn lanes.





Table 7
Level of Service (LOS) Summary
Future Mitigated AM Peak Hour Traffic

Location	Movement	2-Way Stop Control		4-Way Stop Control		1-Lane Roundabout		2-Lane Roundabout		Traffic Signal	
		Avg. Delay	LOS	Avg. Delay	LOS	Avg. Delay	LOS	Avg. Delay	LOS	Avg. Delay	LOS
Nixon Road and Dhu Varren Road/ Green Road	EB Left	<u>160.3</u>	<u>F</u>	13.9	B					16.1	B
	EB Thru	<u>519.0</u>	<u>F</u>	22.5	C	<u>48.0</u>	<u>E</u>	13.5	B	34.6	C
	EB Right	-	-	28.9	D			16.4	C	8.1	A
	WB Left	<u>Err</u>	<u>F</u>	26.0	D					27.2	C
	WB Thru	<u>56.6</u>	<u>F</u>	16.5	C	10.8	B	9.5	A	25.8	C
	WB Right	-	-	14.1	B			5.6	A	0.4	A
	NB Left	8.8	A	23.5	C					18.9	B
	NB Thru	0.0	A	20.6	C	16.8	C	11.6	B	17.4	B
	NB Right	0.0	A	16.5	C			6.9	A	1.9	A
	SB Left	8.3	A	20.8	C			25.7	D	11.6	B
	SB Thru-Right	0.0	A	<u>77.0</u>	<u>F</u>	30.4	D	5.8	A	22.4	C
	Intersection			34.7	D	28.0	D	15.8	C	18.3	B

Notes:

1-Lane Roundabout – Given the single lane roundabout design, all approaches were designed as left-thru-right turn lane.

2-Lane Roundabout – Give the dual lane roundabout design, all approaches were designed with a left-thru lane and a right turn lane.



Table 7 (Continued)

**Level of Service (LOS) Summary
Future Mitigated PM Peak Hour Traffic**

Location	Movement	2-Way Stop Control		4-Way Stop Control		1-Lane Roundabout		2-Lane Roundabout		Traffic Signal	
		Avg. Delay	LOS	Avg. Delay	LOS	Avg. Delay	LOS	Avg. Delay	LOS	Avg. Delay	LOS
Nixon Road and Dhu Varren Road/ Green Road	EB Left	<u>Err</u>	<u>F</u>	14.3	B			6.8	A	17.1	B
	EB Thru	<u>56.6</u>	<u>F</u>	19.6	C	9.5	A	6.2	A	26.5	C
	EB Right	-	-	17.4	C					5.7	A
	WB Left	<u>1164.3</u>	<u>F</u>	15.0	B			12.8	B	17.7	B
	WB Thru	<u>59.7</u>	<u>F</u>	21.3	C	31.3	D	11.2	B	27.6	C
	WB Right	-	-	21.0	C					5.5	A
	NB Left	7.9	A	19.2	C			15.2	C	15.0	B
	NB Thru	0.0	A	<u>57.6</u>	<u>F</u>	21.6	C	5.5	A	25.0	C
	NB Right	0.0	A	13.4	B					1.8	A
	SB Left	8.6	A	15.3	C			8.4	A	13.2	B
	SB Thru-Right	0.0	A	19.2	C	9.1	A	5.6	A	17.7	B
	Intersection	<u>Err</u>	<u>F</u>	27.1	D	20.3	C	11.0	B	17.1	B

Notes:

1-Lane Roundabout – Given the single lane roundabout design, all approaches were designed as left-thru-right turn lane.

2-Lane Roundabout – Give the dual lane roundabout design, all approaches were designed with a left-thru lane and a right turn lane.

CONCLUSIONS

The findings of this study provide the following conclusions:

- Align Dhu Varren Road with Green Road as shown on the site plan. Provide for new traffic control for the newly aligned intersection with a 4-way stop, roundabout or a traffic signal, whichever the City of Ann Arbor deems appropriate for this intersection.
- Provide a new eastbound center left turn lane on Dhu Varren Road opposite the existing center left turn lane on Green Road.
- Provide new head up northbound and southbound center left turn lanes on Nixon Road at the Dhu Varren Road/Green Road intersection.
- Provide new exclusive right turn lanes on eastbound Dhu Varren Road, westbound Green Road and northbound Nixon Road.
- Provide new head up northbound and southbound center left turn lanes on Nixon Road at the North Site Driveway/Barclays Way intersection.
- Provide new head up northbound and southbound center left turn lanes on Nixon Road at the South Site Driveway/Haverhill Court intersection.
- Evaluate the potential replacement of the 2-way stop with a 4-way stop at Nixon Road and Meade Court/Bluett Drive intersection.
- The City of Ann Arbor should review the traffic signal timing and phasing at the intersections of Nixon Road and Plymouth Road, and Huron Parkway and Plymouth Road to determine if the existing leading protected green arrow phase could be replaced with a new permissive/protected lagging left turn phase at each intersection and determine if this would fit into their traffic control system to improve the level of service and reduce the vehicle delays at both of these intersections.
- It is recommended that if the developer would like some type of landscaping or development signing in a boulevard design, that an island be constructed back away from the crossroad a sufficient distance to provide for head up center left turn lanes.



SUPPLEMENTAL INFORMATION

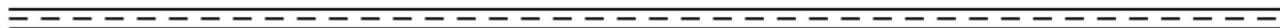

Supplemental Information

Site Plan
Vehicle Volume Counts
Census Population Estimates
Right Turn Lane Calculations
Left Turn Lane Calculations
Traffic Signal Warrant Calculation
LOS Computations



THE NIXON/DHU-VARREN ROAD REALIGNMENT AND INTERSECTION MODIFICATION IS A SEPARATE PROJECT - PROPOSED WORK IN THIS AREA WILL NEED TO BE COORDINATED WITH THIS PROJECT. AS A PART OF THIS PROJECT, EXISTING RIGHT-OF-WAY WILL NEED TO BE VACATED AND NEW RIGHT-OF-WAY DEDICATED. IT IS ASSUMED THAT ALL NEW SIDEWALKS ALONG NIXON AND DHU VARREN STREETS WILL BE A PART OF THE INTERSECTION PROJECT.

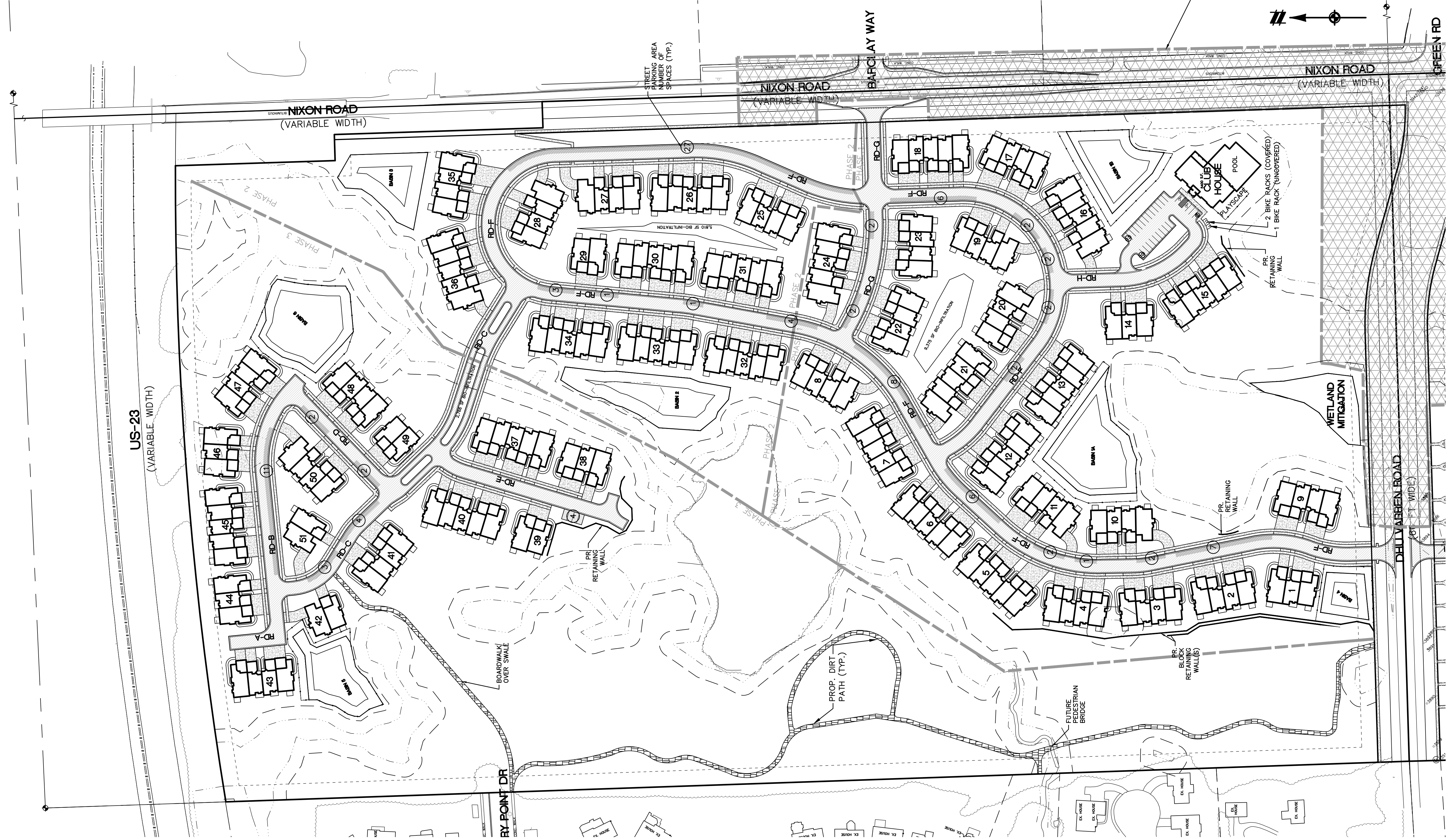

NOTE
PRIVATE DRIVEWAY AISLE WILL BE OWNED AND MAINTAINED BY THE HOMEOWNERS ASSOCIATION.

LEGEND			
	EXIST. WOODS LINE		PROP. R.O.W. LINE
	EXIST. WETLAND LIMITS		PROP. ROAD CENTERLINE
	EXIST. CURB AND GUTTER		PROP. PHASE LINES
	EXIST. EASEMENT		PROP. BACK/EDGE CURB
	BOUNDARY/PROPERTY LINE		PROP. LOT LINE
	SECTION LINE		PROP. EASEMENT
	PROP. ASPHALT		PROP. SETBACK LINE
	PROP. ROAD PARKING		EXIST. UTILITY POLE
			SECTION CORNER
			PARKING



THE LOCATIONS OF EXISTING UNDERGROUND UTILITIES ARE SHOWN IN AN APPROXIMATE WAY ONLY AND HAVE NOT BEEN INDEPENDENTLY VERIFIED BY THE OWNER OR ITS REPRESENTATIVE. THE CONTRACTOR SHALL DETERMINE THE EXACT LOCATION OF ALL EXISTING UTILITIES BEFORE COMMENCING WORK, AND AGREES TO BE FULLY RESPONSIBLE FOR ANY AND ALL DAMAGES WHICH MIGHT BE OCCASIONED BY THE CONTRACTOR'S FAILURE TO EXACTLY LOCATE AND PRESERVE ANY AND ALL UNDERGROUND UTILITIES.

NOTICE:
CONSTRUCTION SITE SAFETY IS THE SOLE RESPONSIBILITY OF THE CONTRACTOR. NEITHER THE OWNER NOR THE ENGINEER SHALL BE EXPECTED TO ASSUME ANY RESPONSIBILITY FOR SAFETY OF THE WORK, OF PERSONS ENGAGED IN THE WORK, OF ANY NEARBY STRUCTURES, OR OF ANY OTHER PERSONS.

COPYRIGHT © 2014 ATWELL, LLC
NO REPRODUCTION SHALL BE MADE WITHOUT THE PRIOR WRITTEN CONSENT OF ATWELL, LLC

Land Development & Real Estate
Power & Energy
Telecommunications
Infrastructure & Transportation
Environmental & Solid Waste
Water & Natural Resources

ATWELL
866.850.4200 | www.atwell-group.com
OFFICES IN NORTH AMERICA AND ASIA

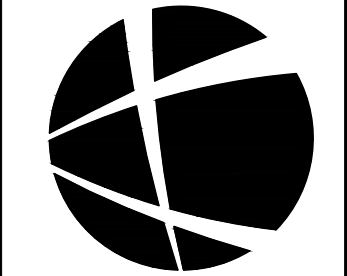

SECTION 10
TOWN 2 SOUTH, RANGE 6 EAST
ANN ARBOR TOWNSHIP
WASHTENAW COUNTY, MICHIGAN

CLIENT: TOLL BROS., INC.
NIXON FARM NORTH
LAYOUT PLAN - OVERALL

DATE: JULY 28, 2014
2014-09-10 PER CITY

REVISIONS

ATWELL

SCALE 0 50 100
1" = 100 FEET

DR. MB CH. TP
P.M. JA
BOOK --
CAD FILE: 13001862SP-06-0L
JOB 13001862
FILE CODE: SP
SHEET NO. 11

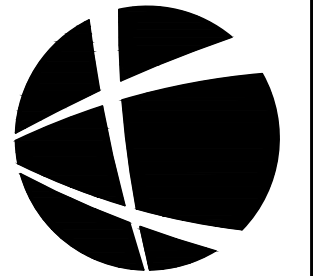

THE NIXON/DHU-VARREN ROAD REALIGNMENT AND INTERSECTION MODIFICATION IS A SEPARATE PROJECT - PROPOSED WORK IN THIS AREA WILL NEED TO BE COORDINATED WITH THIS PROJECT. AS A PART OF THIS PROJECT, EXISTING RIGHT-OF-WAY WILL NEED TO BE VACATED AND NEW RIGHT-OF-WAY DEDICATED. IT IS ASSUMED THAT ALL NEW SIDEWALKS ALONG NIXON AND DHU VARREN STREETS WILL BE PART OF THE INTERSECTION PROJECT.

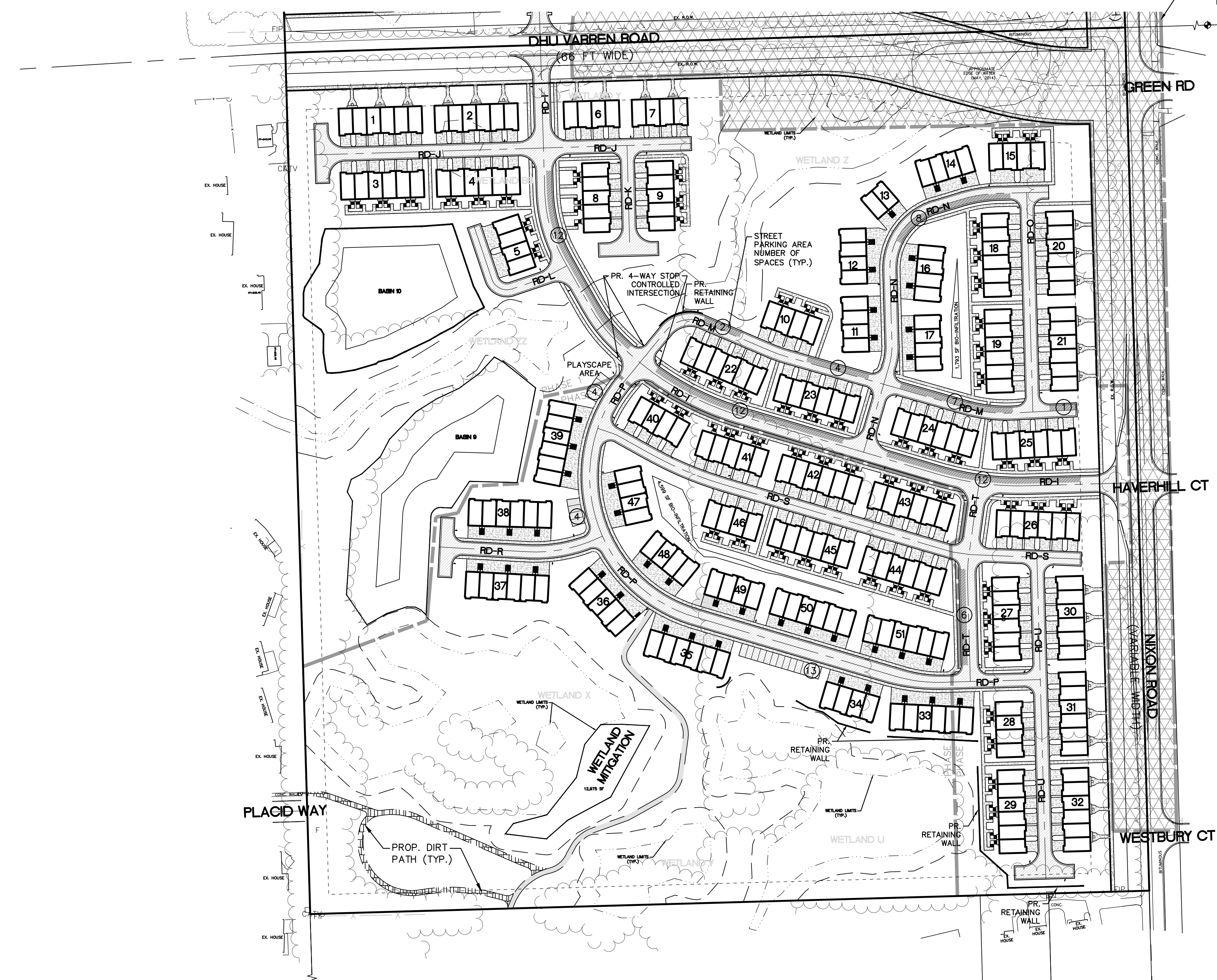

NOTE
 PRIVATE DRIVEWAY AISLE WILL BE OWNED AND MAINTAINED BY THE HOMEOWNERS ASSOCIATION.

LEGEND			
	EXIST. WOODS LINE		PROP. R.O.W. LINE
	EXIST. WETLAND LIMITS		PROP. ROAD CENTERLINE
	EXIST. CURBS AND GUTTERS		PROP. PHASE LINES
	EXIST. EASEMENT		PROP. BACK/EDGE CURB
	BOUNDARY/PROPERTY LINE		PROP. LOT LINE
	SECTION LINE		PROP. EASEMENT
	PROP. ASPHALT		PROP. SETBACK LINE
	PROP. ROAD PARKING		EXIST. UTILITY POLE
			SECTION CORNER
			PARKING



THE LOCATIONS OF EXISTING UNDERGROUND UTILITIES ARE SHOWN IN AN APPROXIMATE WAY ONLY AND HAVE NOT BEEN INDEPENDENTLY VERIFIED BY THE OWNER OR ITS REPRESENTATIVE. THE CONTRACTOR SHALL DETERMINE THE EXACT LOCATION OF ALL EXISTING UTILITIES BEFORE COMMENCING WORK, AND AGREES TO BE FULLY RESPONSIBLE FOR ANY AND ALL DAMAGES WHICH MIGHT BE OCCASIONED BY THE CONTRACTOR'S FAILURE TO EXACTLY LOCATE AND PRESERVE ANY AND ALL UNDERGROUND UTILITIES.

NOTICE:
 CONSTRUCTION SITE SAFETY IS THE SOLE RESPONSIBILITY OF THE CONTRACTOR; NEITHER THE OWNER NOR THE ENGINEER SHALL BE EXPECTED TO ASSUME ANY RESPONSIBILITY FOR SAFETY OF THE WORK, OF PERSONS ENGAGED IN THE WORK, OR OF ANY NEARBY STRUCTURES, OR OF ANY OTHER PERSONS.
 COPYRIGHT © 2014 ATWELL, LLC
 NO REPRODUCTION SHALL BE MADE WITHOUT THE PRIOR WRITTEN CONSENT OF ATWELL, LLC

Traffic Engineering Associates, Inc.

PO Box 100
Saranac, Michigan 48881
517-627-6028

Location: Nixon Rd. & Bluett_Meade Ct
City/County: City of Ann Arbor
Weather: Sunny
Counted By: JJ

File Name : Nixon & Bluett_Meade AM
Site Code : 06041402
Start Date : 6/4/2014
Page No : 1

Groups Printed- Unshifted - Heavy Vehicles

Start Time	Nixon Road From North					Bluett Drive From East					Nixon Road From South					Meade Court From West					Int. Total
	Left	Thru	Right	Peds	App. Total	Left	Thru	Right	Peds	App. Total	Left	Thru	Right	Peds	App. Total	Left	Thru	Right	Peds	App. Total	
07:00 AM	0	62	0	3	65	6	0	0	0	6	0	15	3	0	18	0	1	2	0	3	92
07:15 AM	0	91	0	3	94	4	0	0	2	6	0	13	0	1	14	0	0	1	0	1	115
07:30 AM	2	135	0	8	145	24	0	2	4	30	1	35	9	1	46	1	0	2	0	3	224
07:45 AM	3	127	0	5	135	30	0	5	4	39	1	55	22	0	78	0	0	3	0	3	255
Total	5	415	0	19	439	64	0	7	10	81	2	118	34	2	156	1	1	8	0	10	686
08:00 AM	5	110	0	3	118	42	0	14	3	59	0	66	22	3	91	0	1	2	0	3	271
08:15 AM	6	107	0	1	114	24	1	3	1	29	1	45	17	0	63	1	0	3	0	4	210
08:30 AM	5	121	0	5	131	27	0	3	0	30	0	57	8	1	66	1	0	4	0	5	232
08:45 AM	16	156	0	3	175	9	0	4	2	15	1	99	7	1	108	0	0	5	0	5	303
Total	32	494	0	12	538	102	1	24	6	133	2	267	54	5	328	2	1	14	0	17	1016
Grand Total	37	909	0	31	977	166	1	31	16	214	4	385	88	7	484	3	2	22	0	27	1702
Apprch %	3.8	93	0	3.2		77.6	0.5	14.5	7.5		0.8	79.5	18.2	1.4		11.1	7.4	81.5	0		
Total %	2.2	53.4	0	1.8	57.4	9.8	0.1	1.8	0.9	12.6	0.2	22.6	5.2	0.4	28.4	0.2	0.1	1.3	0	1.6	
Unshifted	35	878	0	31	944	164	1	30	16	211	4	363	86	7	460	3	2	22	0	27	1642
% Unshifted	94.6	96.6	0	100	96.6	98.8	100	96.8	100	98.6	100	94.3	97.7	100	95	100	100	100	0	100	96.5
Heavy Vehicles	2	31	0	0	33	2	0	1	0	3	0	22	2	0	24	0	0	0	0	0	60
% Heavy Vehicles	5.4	3.4	0	0	3.4	1.2	0	3.2	0	1.4	0	5.7	2.3	0	5	0	0	0	0	0	3.5

Start Time	Nixon Road From North					Bluett Drive From East					Nixon Road From South					Meade Court From West					Int. Total
	Left	Thru	Right	Peds	App. Total	Left	Thru	Right	Peds	App. Total	Left	Thru	Right	Peds	App. Total	Left	Thru	Right	Peds	App. Total	
Peak Hour Analysis From 07:00 AM to 08:45 AM - Peak 1 of 1																					
Peak Hour for Entire Intersection Begins at 08:00 AM																					
08:00 AM	5	110	0	3	118	42	0	14	3	59	0	66	22	3	91	0	1	2	0	3	271
08:15 AM	6	107	0	1	114	24	1	3	1	29	1	45	17	0	63	1	0	3	0	4	210
08:30 AM	5	121	0	5	131	27	0	3	0	30	0	57	8	1	66	1	0	4	0	5	232
08:45 AM	16	156	0	3	175	9	0	4	2	15	1	99	7	1	108	0	0	5	0	5	303
Total Volume	32	494	0	12	538	102	1	24	6	133	2	267	54	5	328	2	1	14	0	17	1016
% App. Total	5.9	91.8	0	2.2		76.7	0.8	18	4.5		0.6	81.4	16.5	1.5		11.8	5.9	82.4	0		
PHF	.500	.792	.000	.600	.769	.607	.250	.429	.500	.564	.500	.674	.614	.417	.759	.500	.250	.700	.000	.850	.838
Unshifted	30	470	0	12	512	102	1	23	6	132	2	259	54	5	320	2	1	14	0	17	981
% Unshifted	93.8	95.1	0	100	95.2	100	100	95.8	100	99.2	100	97.0	100	100	97.6	100	100	100	0	100	96.6
Heavy Vehicles	2	24	0	0	26	0	0	1	0	1	0	8	0	0	8	0	0	0	0	0	35
% Heavy Vehicles	6.3	4.9	0	0	4.8	0	0	4.2	0	0.8	0	3.0	0	0	2.4	0	0	0	0	0	3.4

Traffic Engineering Associates, Inc.

PO Box 100
Saranac, Michigan 48881
517-627-6028

Location: Nixon Rd. & Bluett_Meade Ct
City/County: City of Ann Arbor
Weather: Sunny
Counted By: JJ

File Name : Nixon & Bluett_Meade AM
Site Code : 06041402
Start Date : 6/4/2014
Page No : 2

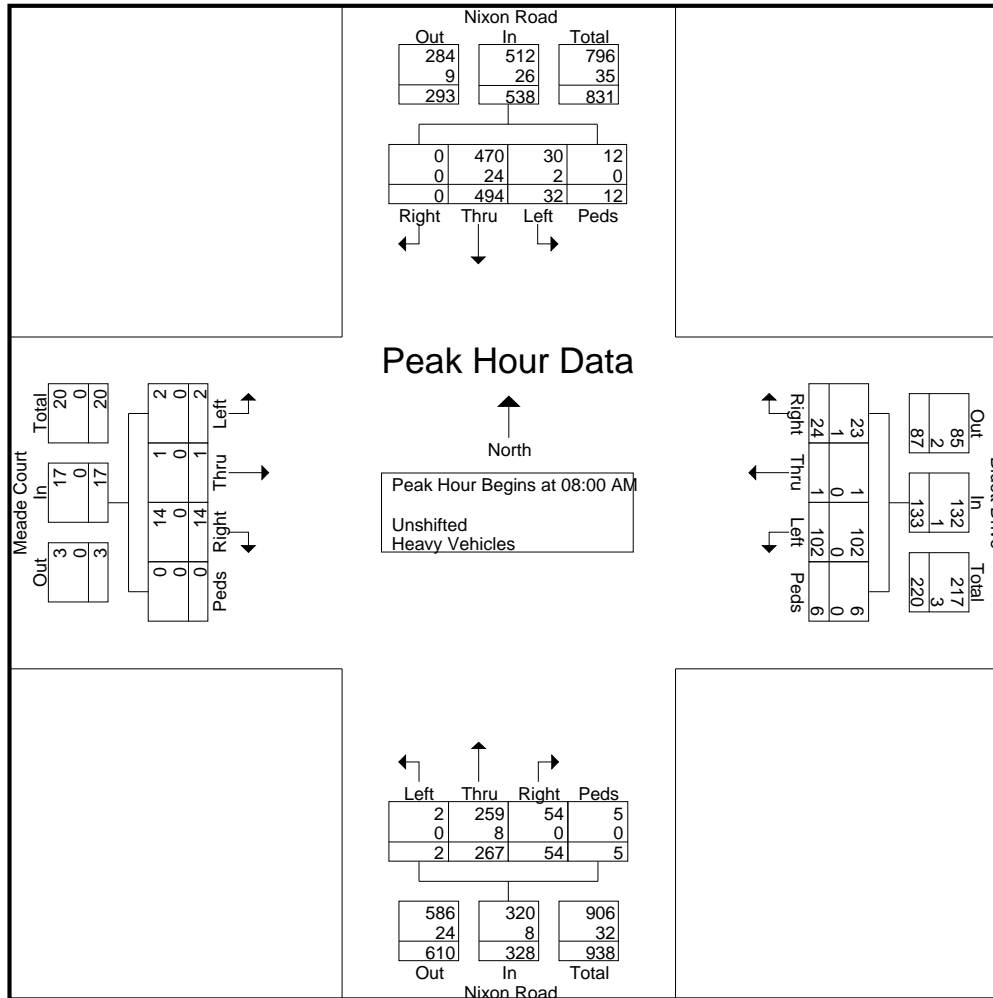

Traffic Engineering Associates, Inc.

PO Box 100
Saranac, Michigan 48881
517-627-6028

Location: Nixon Rd. & Bluett _ Meade Ct
City/County: City of Ann Arbor
Weather: Sunny
Counted By: JJ

File Name : Nixon & Bluett_Meade PM
Site Code : 06031401
Start Date : 6/3/2014
Page No : 1

Groups Printed- Unshifted - Heavy Vehicles

Start Time	Nixon Road From North					Meade Court From East					Nixon Road From South					Bluett Drive From West					Int. Total
	Left	Thru	Right	Peds	App. Total	Left	Thru	Right	Peds	App. Total	Left	Thru	Right	Peds	App. Total	Left	Thru	Right	Peds	App. Total	
04:00 PM	1	70	0	15	86	10	0	3	4	17	2	127	13	1	143	0	0	3	0	3	249
04:15 PM	6	66	0	0	72	7	1	4	1	13	0	89	12	2	103	1	0	1	0	2	190
04:30 PM	0	56	0	1	57	10	1	4	0	15	4	113	18	3	138	0	0	0	0	0	210
04:45 PM	5	67	1	3	76	14	0	2	2	18	2	145	15	1	163	0	0	1	0	1	258
Total	12	259	1	19	291	41	2	13	7	63	8	474	58	7	547	1	0	5	0	6	907
05:00 PM	2	69	0	0	71	14	0	3	1	18	4	131	14	0	149	0	0	4	0	4	242
05:15 PM	6	62	1	0	69	13	0	5	4	22	3	135	17	7	162	0	0	3	0	3	256
05:30 PM	5	77	0	7	89	11	0	1	1	13	5	148	9	1	163	0	0	1	0	1	266
05:45 PM	2	77	0	2	81	9	0	6	0	15	5	134	19	0	158	1	1	4	0	6	260
Total	15	285	1	9	310	47	0	15	6	68	17	548	59	8	632	1	1	12	0	14	1024
Grand Total	27	544	2	28	601	88	2	28	13	131	25	1022	117	15	1179	2	1	17	0	20	1931
Apprch %	4.5	90.5	0.3	4.7		67.2	1.5	21.4	9.9		2.1	86.7	9.9	1.3		10	5	85	0		
Total %	1.4	28.2	0.1	1.5	31.1	4.6	0.1	1.5	0.7	6.8	1.3	52.9	6.1	0.8	61.1	0.1	0.1	0.9	0	1	
Unshifted	27	530	2	28	587	87	2	26	13	128	25	1009	116	15	1165	2	1	17	0	20	1900
% Unshifted	100	97.4	100	100	97.7	98.9	100	92.9	100	97.7	100	98.7	99.1	100	98.8	100	100	100	0	100	98.4
Heavy Vehicles	0	14	0	0	14	1	0	2	0	3	0	13	1	0	14	0	0	0	0	0	31
% Heavy Vehicles	0	2.6	0	0	2.3	1.1	0	7.1	0	2.3	0	1.3	0.9	0	1.2	0	0	0	0	0	1.6

Start Time	Nixon Road From North					Meade Court From East					Nixon Road From South					Bluett Drive From West					Int. Total
	Left	Thru	Right	Peds	App. Total	Left	Thru	Right	Peds	App. Total	Left	Thru	Right	Peds	App. Total	Left	Thru	Right	Peds	App. Total	
Peak Hour Analysis From 04:00 PM to 05:45 PM - Peak 1 of 1																					
Peak Hour for Entire Intersection Begins at 05:00 PM																					
05:00 PM	2	69	0	0	71	14	0	3	1	18	4	131	14	0	149	0	0	4	0	4	242
05:15 PM	6	62	1	0	69	13	0	5	4	22	3	135	17	7	162	0	0	3	0	3	256
05:30 PM	5	77	0	7	89	11	0	1	1	13	5	148	9	1	163	0	0	1	0	1	266
05:45 PM	2	77	0	2	81	9	0	6	0	15	5	134	19	0	158	1	1	4	0	6	260
Total Volume	15	285	1	9	310	47	0	15	6	68	17	548	59	8	632	1	1	12	0	14	1024
% App. Total	4.8	91.9	0.3	2.9		69.1	0	22.1	8.8		2.7	86.7	9.3	1.3		7.1	7.1	85.7	0		
PHF	.625	.925	.250	.321	.871	.839	.000	.625	.375	.773	.850	.926	.776	.286	.969	.250	.250	.750	.000	.583	.962
Unshifted	15	283	1	9	308	46	0	15	6	67	17	544	59	8	628	1	1	12	0	14	1017
% Unshifted	100	99.3	100	100	99.4	97.9	0	100	100	98.5	100	99.3	100	100	99.4	100	100	100	0	100	99.3
Heavy Vehicles	0	2	0	0	2	1	0	0	0	1	0	4	0	0	4	0	0	0	0	0	7
% Heavy Vehicles	0	0.7	0	0	0.6	2.1	0	0	0	1.5	0	0.7	0	0	0.6	0	0	0	0	0	0.7

Traffic Engineering Associates, Inc.

PO Box 100
Saranac, Michigan 48881
517-627-6028

Location: Nixon Rd. & Bluett _ Meade Ct
City/County: City of Ann Arbor
Weather: Sunny
Counted By: JJ

File Name : Nixon & Bluett_Meade PM
Site Code : 06031401
Start Date : 6/3/2014
Page No : 2

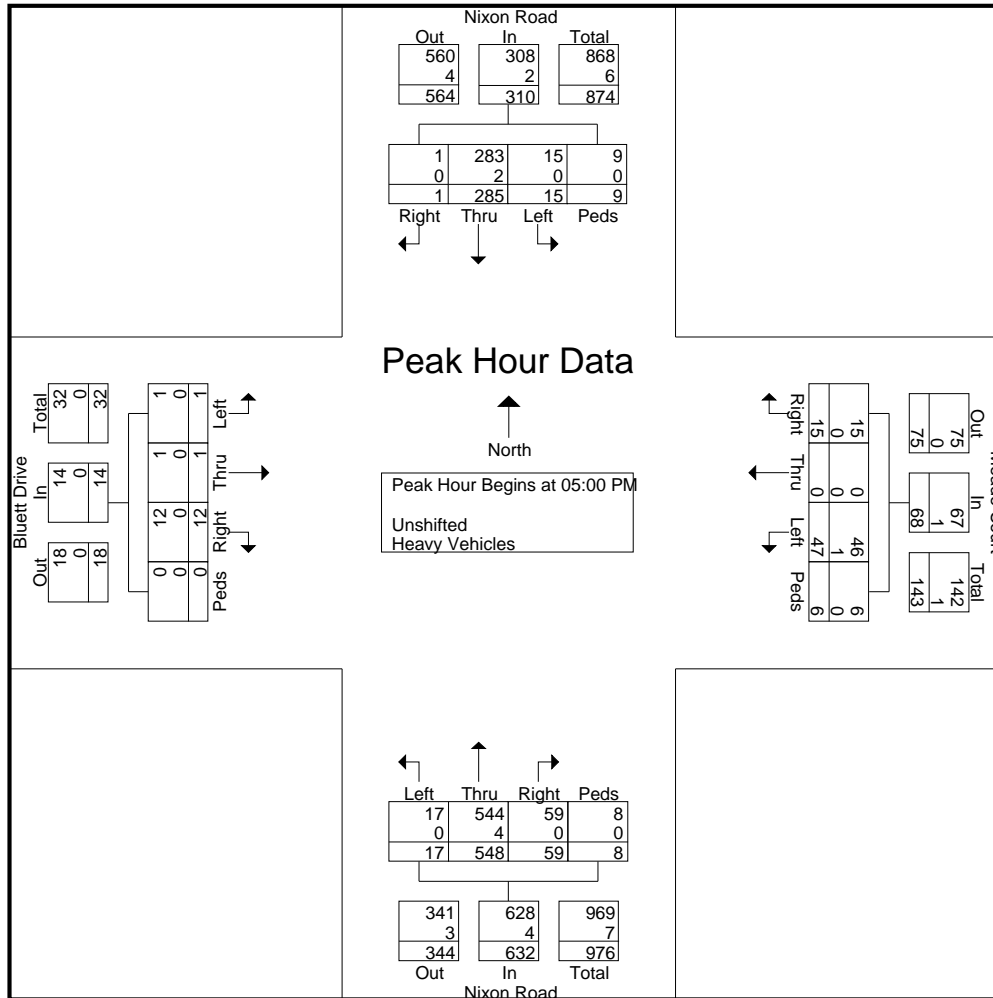

Traffic Engineering Associates, Inc.

PO Box 100
Saranac, MI 4888
517-627-6028

Location: Nixon & Green_Dhu Varren
City/County: City of Ann Arbor
Weather: Sunny
Counted By: JJ

File Name : nixon & green_dhu varren am a
Site Code : 06031402
Start Date : 6/3/2014
Page No : 1

Groups Printed- Unshifted - Heavy Vehicles

Start Time	Nixon Road From North					Green Road From East					Nixon Road From South					Dhu Varren Road From West					Int. Total
	Left	Thru	Right	Peds	App. Total	Left	Thru	Right	Peds	App. Total	Left	Thru	Right	Peds	App. Total	Left	Thru	Right	Peds	App. Total	
07:00 AM	14	42	0	0	56	6	8	6	0	20	5	3	2	0	10	2	29	13	0	44	130
07:15 AM	30	52	3	0	85	15	14	4	0	33	3	7	10	0	20	2	31	25	0	58	196
07:30 AM	30	61	6	0	97	18	11	6	0	35	7	12	4	1	24	2	42	40	0	84	240
07:45 AM	26	68	3	0	97	32	18	10	0	60	24	21	14	0	59	4	43	39	0	86	302
Total	100	223	12	0	335	71	51	26	0	148	39	43	30	1	113	10	145	117	0	272	868
08:00 AM	22	64	4	0	90	41	11	8	0	60	28	29	27	2	86	2	44	48	0	94	330
08:15 AM	28	64	4	0	96	17	8	6	0	31	18	15	10	0	43	5	48	34	0	87	257
08:30 AM	29	54	0	0	83	25	14	4	0	43	8	11	7	4	30	2	33	55	0	90	246
08:45 AM	17	50	4	0	71	37	23	9	0	69	30	11	14	2	57	2	24	61	0	87	284
Total	96	232	12	0	340	120	56	27	0	203	84	66	58	8	216	11	149	198	0	358	1117
Grand Total	196	455	24	0	675	191	107	53	0	351	123	109	88	9	329	21	294	315	0	630	1985
Apprch %	29	67.4	3.6	0		54.4	30.5	15.1	0		37.4	33.1	26.7	2.7		3.3	46.7	50	0		
Total %	9.9	22.9	1.2	0	34	9.6	5.4	2.7	0	17.7	6.2	5.5	4.4	0.5	16.6	1.1	14.8	15.9	0	31.7	
Unshifted	194	447	22	0	663	182	104	51	0	337	111	105	83	9	308	19	290	296	0	605	1913
% Unshifted	99	98.2	91.7	0	98.2	95.3	97.2	96.2	0	96	90.2	96.3	94.3	100	93.6	90.5	98.6	94	0	96	96.4
Heavy Vehicles	2	8	2	0	12	9	3	2	0	14	12	4	5	0	21	2	4	19	0	25	72
% Heavy Vehicles	1	1.8	8.3	0	1.8	4.7	2.8	3.8	0	4	9.8	3.7	5.7	0	6.4	9.5	1.4	6	0	4	3.6

Start Time	Nixon Road From North					Green Road From East					Nixon Road From South					Dhu Varren Road From West					Int. Total
	Left	Thru	Right	Peds	App. Total	Left	Thru	Right	Peds	App. Total	Left	Thru	Right	Peds	App. Total	Left	Thru	Right	Peds	App. Total	
Peak Hour Analysis From 07:00 AM to 08:45 AM - Peak 1 of 1																					
Peak Hour for Entire Intersection Begins at 07:45 AM																					
07:45 AM	26	68	3	0	97	32	18	10	0	60	24	21	14	0	59	4	43	39	0	86	302
08:00 AM	22	64	4	0	90	41	11	8	0	60	28	29	27	2	86	2	44	48	0	94	330
08:15 AM	28	64	4	0	96	17	8	6	0	31	18	15	10	0	43	5	48	34	0	87	257
08:30 AM	29	54	0	0	83	25	14	4	0	43	8	11	7	4	30	2	33	55	0	90	246
Total Volume	105	250	11	0	366	115	51	28	0	194	78	76	58	6	218	13	168	176	0	357	1135
% App. Total	28.7	68.3	3	0		59.3	26.3	14.4	0		35.8	34.9	26.6	2.8		3.6	47.1	49.3	0		
PHF	.905	.919	.688	.000	.943	.701	.708	.700	.000	.808	.696	.655	.537	.375	.634	.650	.875	.800	.000	.949	.860
Unshifted	105	244	11	0	360	110	51	27	0	188	68	73	55	6	202	12	166	166	0	344	1094
% Unshifted	100	97.6	100	0	98.4	95.7	100	96.4	0	96.9	87.2	96.1	94.8	100	92.7	92.3	98.8	94.3	0	96.4	96.4
Heavy Vehicles	0	6	0	0	6	5	0	1	0	6	10	3	3	0	16	1	2	10	0	13	41
% Heavy Vehicles	0	2.4	0	0	1.6	4.3	0	3.6	0	3.1	12.8	3.9	5.2	0	7.3	7.7	1.2	5.7	0	3.6	3.6

Traffic Engineering Associates, Inc.

PO Box 100
Saranac, MI 4888
517-627-6028

Location: Nixon and Green/Dhu Varren
City/County: City of Ann Arbor
Weather: Sunny
Counted By: JJ

File Name : nixon & green_dhu varren pm a
Site Code : 06021401
Start Date : 6/2/2014
Page No : 1

Groups Printed- Unshifted - Heavy Vehicles

Start Time	Nixon Road From North					Green Road From East					Nixon Road From South					Dhu Varren Road From West					Int. Total
	Left	Thru	Right	Peds	App. Total	Left	Thru	Right	Peds	App. Total	Left	Thru	Right	Peds	App. Total	Left	Thru	Right	Peds	App. Total	
04:00 PM	6	16	1	0	23	10	22	9	0	41	45	55	26	1	127	4	17	14	0	35	226
04:15 PM	7	19	3	0	29	13	28	19	0	60	29	57	14	1	101	1	24	13	0	38	228
04:30 PM	4	20	1	0	25	14	25	26	0	65	20	60	22	0	102	1	15	23	0	39	231
04:45 PM	9	19	3	0	31	10	28	28	0	66	37	49	22	6	114	2	18	22	0	42	253
Total	26	74	8	0	108	47	103	82	0	232	131	221	84	8	444	8	74	72	0	154	938
05:00 PM	6	19	3	0	28	12	40	27	0	79	26	73	22	3	124	2	16	23	0	41	272
05:15 PM	10	16	3	0	29	8	39	48	0	95	26	66	19	0	111	2	34	23	0	59	294
05:30 PM	12	15	4	0	31	13	35	49	0	97	30	58	20	7	115	5	28	24	0	57	300
05:45 PM	7	16	4	0	27	14	38	29	0	81	37	50	20	0	107	5	37	29	0	71	286
Total	35	66	14	0	115	47	152	153	0	352	119	247	81	10	457	14	115	99	0	228	1152
Grand Total	61	140	22	0	223	94	255	235	0	584	250	468	165	18	901	22	189	171	0	382	2090
Apprch %	27.4	62.8	9.9	0		16.1	43.7	40.2	0		27.7	51.9	18.3	2		5.8	49.5	44.8	0		
Total %	2.9	6.7	1.1	0	10.7	4.5	12.2	11.2	0	27.9	12	22.4	7.9	0.9	43.1	1.1	9	8.2	0	18.3	
Unshifted	61	137	20	0	218	89	252	234	0	575	244	463	157	18	882	22	185	162	0	369	2044
% Unshifted	100	97.9	90.9	0	97.8	94.7	98.8	99.6	0	98.5	97.6	98.9	95.2	100	97.9	100	97.9	94.7	0	96.6	97.8
Heavy Vehicles	0	3	2	0	5	5	3	1	0	9	6	5	8	0	19	0	4	9	0	13	46
% Heavy Vehicles	0	2.1	9.1	0	2.2	5.3	1.2	0.4	0	1.5	2.4	1.1	4.8	0	2.1	0	2.1	5.3	0	3.4	2.2

Start Time	Nixon Road From North					Green Road From East					Nixon Road From South					Dhu Varren Road From West					Int. Total
	Left	Thru	Right	Peds	App. Total	Left	Thru	Right	Peds	App. Total	Left	Thru	Right	Peds	App. Total	Left	Thru	Right	Peds	App. Total	
Peak Hour Analysis From 04:00 PM to 05:45 PM - Peak 1 of 1																					
Peak Hour for Entire Intersection Begins at 05:00 PM																					
05:00 PM	6	19	3	0	28	12	40	27	0	79	26	73	22	3	124	2	16	23	0	41	272
05:15 PM	10	16	3	0	29	8	39	48	0	95	26	66	19	0	111	2	34	23	0	59	294
05:30 PM	12	15	4	0	31	13	35	49	0	97	30	58	20	7	115	5	28	24	0	57	300
05:45 PM	7	16	4	0	27	14	38	29	0	81	37	50	20	0	107	5	37	29	0	71	286
Total Volume	35	66	14	0	115	47	152	153	0	352	119	247	81	10	457	14	115	99	0	228	1152
% App. Total	30.4	57.4	12.2	0		13.4	43.2	43.5	0		26	54	17.7	2.2		6.1	50.4	43.4	0		
PHF	.729	.868	.875	.000	.927	.839	.950	.781	.000	.907	.804	.846	.920	.357	.921	.700	.777	.853	.000	.803	.960
Unshifted	35	64	14	0	113	46	151	152	0	349	117	246	77	10	450	14	113	96	0	223	1135
% Unshifted	100	97.0	100	0	98.3	97.9	99.3	99.3	0	99.1	98.3	99.6	95.1	100	98.5	100	98.3	97.0	0	97.8	98.5
Heavy Vehicles	0	2	0	0	2	1	1	1	0	3	2	1	4	0	7	0	2	3	0	5	17
% Heavy Vehicles	0	3.0	0	0	1.7	2.1	0.7	0.7	0	0.9	1.7	0.4	4.9	0	1.5	0	1.7	3.0	0	2.2	1.5

Traffic Engineering Associates, Inc.

PO Box 100
Saranac, MI 4888
517-627-6028

Location: Nixon and Green/Dhu Varren
City/County: City of Ann Arbor
Weather: Sunny
Counted By: JJ

File Name : nixon & green_dhu varren pm a
Site Code : 06021401
Start Date : 6/2/2014
Page No : 2

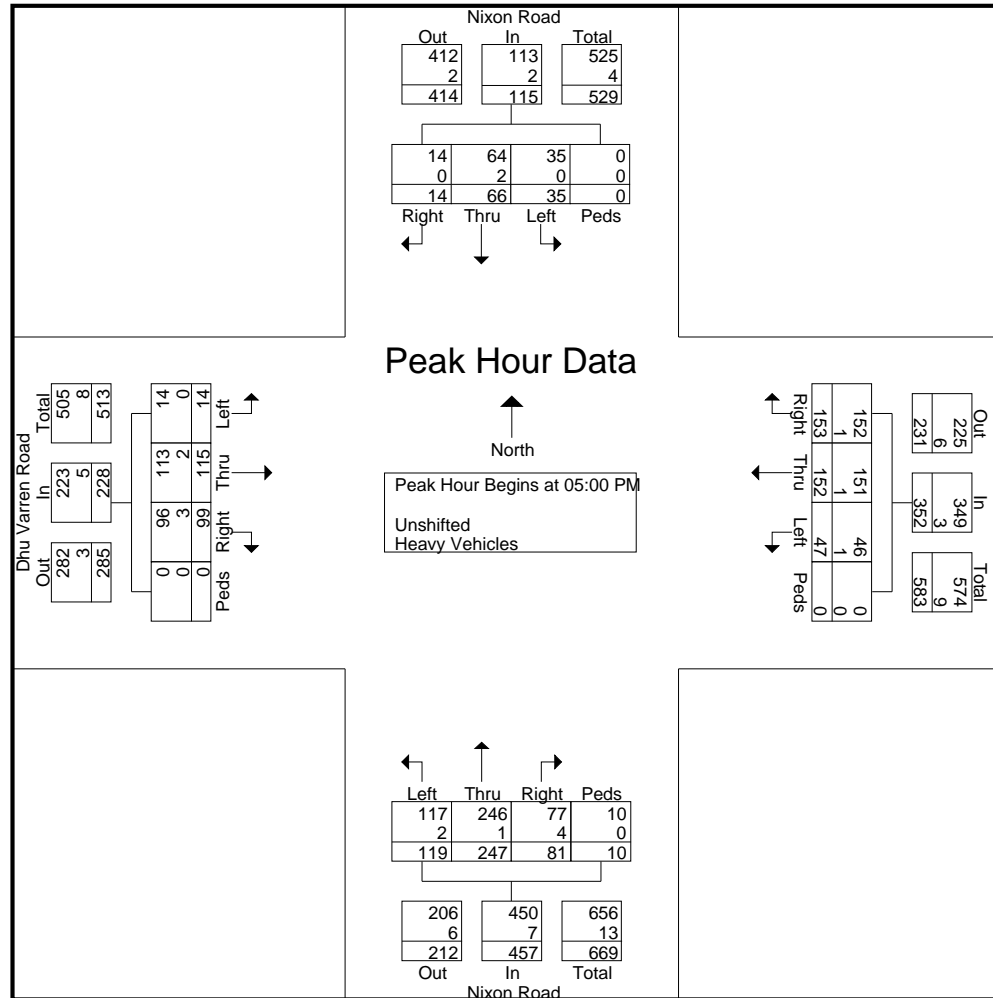

Traffic Engineering Associates, Inc.

PO Box 100
Saranac, Michigan 48881
517-627-6028

Location: Nixon Rd. & Plymouth Rd.
City/County: City of Ann Arbor
Weather: Sunny
Counted By: JJ

File Name : Nixon & Plymouth AM
Site Code : 06051402
Start Date : 6/5/2014
Page No : 1

Groups Printed- Unshifted - Heavy Vehicles

Start Time	Nixon Road From North					Plymouth Road From East					U of M Driveway From South					Plymouth Road From West					Int. Total
	Left	Thru	Right	Peds	App. Total	Left	Thru	Right	Peds	App. Total	Left	Thru	Right	Peds	App. Total	Left	Thru	Right	Peds	App. Total	
07:00 AM	17	3	26	0	46	0	107	14	0	121	2	0	0	0	2	9	78	10	0	97	266
07:15 AM	11	9	27	0	47	1	161	16	1	179	0	0	0	0	0	8	106	11	0	125	351
07:30 AM	39	16	61	0	116	4	160	22	1	187	3	0	0	0	3	15	155	15	0	185	491
07:45 AM	31	4	42	0	77	3	161	16	2	182	1	0	2	0	3	23	179	24	0	226	488
Total	98	32	156	0	286	8	589	68	4	669	6	0	2	0	8	55	518	60	0	633	1596
08:00 AM	34	14	41	0	89	1	216	28	0	245	4	3	3	0	10	17	154	17	0	188	532
08:15 AM	41	18	49	0	108	2	183	16	0	201	1	1	3	0	5	22	171	18	0	211	525
08:30 AM	36	14	24	0	74	1	186	28	2	217	6	3	2	0	11	19	194	13	0	226	528
08:45 AM	62	13	50	0	125	9	192	31	3	235	2	4	0	0	6	19	178	27	0	224	590
Total	173	59	164	0	396	13	777	103	5	898	13	11	8	0	32	77	697	75	0	849	2175
Grand Total	271	91	320	0	682	21	1366	171	9	1567	19	11	10	0	40	132	1215	135	0	1482	3771
Apprch %	39.7	13.3	46.9	0		1.3	87.2	10.9	0.6		47.5	27.5	25	0		8.9	82	9.1	0		
Total %	7.2	2.4	8.5	0	18.1	0.6	36.2	4.5	0.2	41.6	0.5	0.3	0.3	0	1.1	3.5	32.2	3.6	0	39.3	
Unshifted	266	91	301	0	658	21	1328	168	9	1526	12	11	10	0	33	112	1182	128	0	1422	3639
% Unshifted	98.2	100	94.1	0	96.5	100	97.2	98.2	100	97.4	63.2	100	100	0	82.5	84.8	97.3	94.8	0	96	96.5
Heavy Vehicles	5	0	19	0	24	0	38	3	0	41	7	0	0	0	7	20	33	7	0	60	132
% Heavy Vehicles	1.8	0	5.9	0	3.5	0	2.8	1.8	0	2.6	36.8	0	0	0	17.5	15.2	2.7	5.2	0	4	3.5

Start Time	Nixon Road From North					Plymouth Road From East					U of M Driveway From South					Plymouth Road From West					Int. Total
	Left	Thru	Right	Peds	App. Total	Left	Thru	Right	Peds	App. Total	Left	Thru	Right	Peds	App. Total	Left	Thru	Right	Peds	App. Total	

Peak Hour Analysis From 07:00 AM to 08:45 AM - Peak 1 of 1

Peak Hour for Entire Intersection Begins at 08:00 AM

08:00 AM	34	14	41	0	89	1	216	28	0	245	4	3	3	0	10	17	154	17	0	188	532
08:15 AM	41	18	49	0	108	2	183	16	0	201	1	1	3	0	5	22	171	18	0	211	525
08:30 AM	36	14	24	0	74	1	186	28	2	217	6	3	2	0	11	19	194	13	0	226	528
08:45 AM	62	13	50	0	125	9	192	31	3	235	2	4	0	0	6	19	178	27	0	224	590
Total Volume	173	59	164	0	396	13	777	103	5	898	13	11	8	0	32	77	697	75	0	849	2175
% App. Total	43.7	14.9	41.4	0		1.4	86.5	11.5	0.6		40.6	34.4	25	0		9.1	82.1	8.8	0		
PHF	.698	.819	.820	.000	.792	.361	.899	.831	.417	.916	.542	.688	.667	.000	.727	.875	.898	.694	.000	.939	.922
Unshifted	171	59	154	0	384	13	752	101	5	871	9	11	8	0	28	68	676	71	0	815	2098
% Unshifted	98.8	100	93.9	0	97.0	100	96.8	98.1	100	97.0	69.2	100	100	0	87.5	88.3	97.0	94.7	0	96.0	96.5
Heavy Vehicles	2	0	10	0	12	0	25	2	0	27	4	0	0	0	4	9	21	4	0	34	77
% Heavy Vehicles	1.2	0	6.1	0	3.0	0	3.2	1.9	0	3.0	30.8	0	0	0	12.5	11.7	3.0	5.3	0	4.0	3.5

Traffic Engineering Associates, Inc.

PO Box 100
Saranac, Michigan 48881
517-627-6028

Location: Nixon Rd. & Plymouth Rd.
City/County: City of Ann Arbor
Weather: Sunny
Counted By: JJ

File Name : Nixon & Plymouth AM
Site Code : 06051402
Start Date : 6/5/2014
Page No : 2

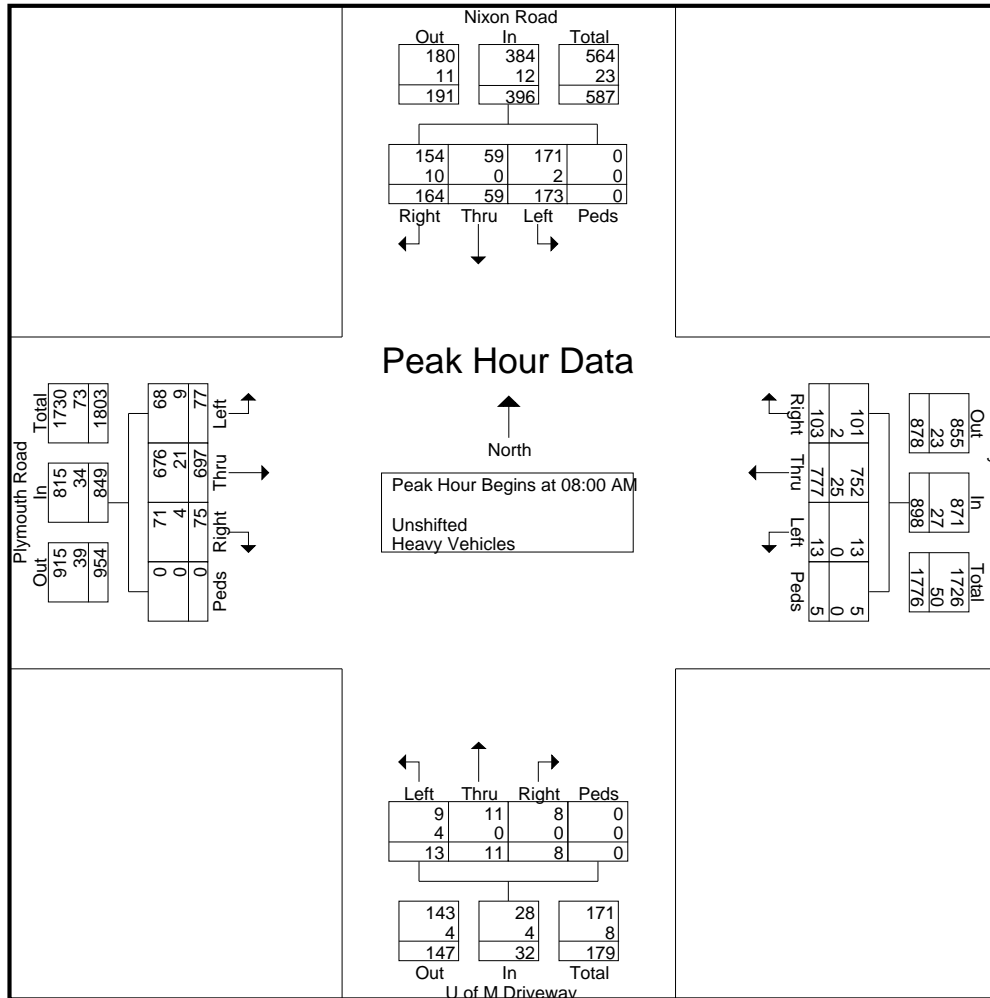

Traffic Engineering Associates, Inc.

PO Box 100
Saranac, Michigan 48881
517-627-6028

Location: Nixon Rd. & Plymouth Rd.
City/County: City of Ann Arbor
Weather: Sunny
Counted By: JJ

File Name : Nixon & Plymouth PM
Site Code : 06041401
Start Date : 6/4/2014
Page No : 1

Groups Printed- Unshifted - Heavy Vehicles

Start Time	Nixon Road From North					Plymouth Road From East					U of M Driveway From South					Plymouth Road From West					Int. Total
	Left	Thru	Right	Peds	App. Total	Left	Thru	Right	Peds	App. Total	Left	Thru	Right	Peds	App. Total	Left	Thru	Right	Peds	App. Total	
04:00 PM	45	2	25	0	72	3	167	36	0	206	14	2	4	0	20	37	187	3	0	227	525
04:15 PM	37	2	23	0	62	0	151	33	3	187	19	6	7	0	32	36	165	6	0	207	488
04:30 PM	55	2	38	0	95	0	161	38	0	199	15	16	13	0	44	40	186	4	0	230	568
04:45 PM	54	2	31	0	87	2	174	25	0	201	12	5	6	0	23	34	209	1	0	244	555
Total	191	8	117	0	316	5	653	132	3	793	60	29	30	0	119	147	747	14	0	908	2136
05:00 PM	73	8	28	0	109	3	213	23	2	241	34	9	13	0	56	43	180	12	0	235	641
05:15 PM	63	3	46	0	112	5	221	28	1	255	22	15	14	0	51	43	168	11	0	222	640
05:30 PM	49	2	28	0	79	2	188	25	2	217	24	19	8	0	51	50	204	6	0	260	607
05:45 PM	57	1	55	0	113	2	195	23	1	221	7	6	3	0	16	52	164	4	0	220	570
Total	242	14	157	0	413	12	817	99	6	934	87	49	38	0	174	188	716	33	0	937	2458
Grand Total	433	22	274	0	729	17	1470	231	9	1727	147	78	68	0	293	335	1463	47	0	1845	4594
Apprch %	59.4	3	37.6	0		1	85.1	13.4	0.5		50.2	26.6	23.2	0		18.2	79.3	2.5	0		
Total %	9.4	0.5	6	0	15.9	0.4	32	5	0.2	37.6	3.2	1.7	1.5	0	6.4	7.3	31.8	1	0	40.2	
Unshifted	428	22	261	0	711	17	1458	230	9	1714	141	78	68	0	287	319	1442	40	0	1801	4513
% Unshifted	98.8	100	95.3	0	97.5	100	99.2	99.6	100	99.2	95.9	100	100	0	98	95.2	98.6	85.1	0	97.6	98.2
Heavy Vehicles	5	0	13	0	18	0	12	1	0	13	6	0	0	0	6	16	21	7	0	44	81
% Heavy Vehicles	1.2	0	4.7	0	2.5	0	0.8	0.4	0	0.8	4.1	0	0	0	2	4.8	1.4	14.9	0	2.4	1.8

Start Time	Nixon Road From North					Plymouth Road From East					U of M Driveway From South					Plymouth Road From West					Int. Total
	Left	Thru	Right	Peds	App. Total	Left	Thru	Right	Peds	App. Total	Left	Thru	Right	Peds	App. Total	Left	Thru	Right	Peds	App. Total	

Peak Hour Analysis From 04:00 PM to 05:45 PM - Peak 1 of 1

Peak Hour for Entire Intersection Begins at 05:00 PM

05:00 PM	73	8	28	0	109	3	213	23	2	241	34	9	13	0	56	43	180	12	0	235	641
05:15 PM	63	3	46	0	112	5	221	28	1	255	22	15	14	0	51	43	168	11	0	222	640
05:30 PM	49	2	28	0	79	2	188	25	2	217	24	19	8	0	51	50	204	6	0	260	607
05:45 PM	57	1	55	0	113	2	195	23	1	221	7	6	3	0	16	52	164	4	0	220	570
Total Volume	242	14	157	0	413	12	817	99	6	934	87	49	38	0	174	188	716	33	0	937	2458
% App. Total	58.6	3.4	38	0		1.3	87.5	10.6	0.6		50	28.2	21.8	0		20.1	76.4	3.5	0		
PHF	.829	.438	.714	.000	.914	.600	.924	.884	.750	.916	.640	.645	.679	.000	.777	.904	.877	.688	.000	.901	.959
Unshifted	240	14	150	0	404	12	812	99	6	929	85	49	38	0	172	180	707	29	0	916	2421
% Unshifted	99.2	100	95.5	0	97.8	100	99.4	100	100	99.5	97.7	100	100	0	98.9	95.7	98.7	87.9	0	97.8	98.5
Heavy Vehicles	2	0	7	0	9	0	5	0	0	5	2	0	0	0	2	8	9	4	0	21	37
% Heavy Vehicles	0.8	0	4.5	0	2.2	0	0.6	0	0	0.5	2.3	0	0	0	1.1	4.3	1.3	12.1	0	2.2	1.5

Traffic Engineering Associates, Inc.

PO Box 100
Saranac, Michigan 48881
517-627-6028

Location: Nixon Rd. & Plymouth Rd.
City/County: City of Ann Arbor
Weather: Sunny
Counted By: JJ

File Name : Nixon & Plymouth PM
Site Code : 06041401
Start Date : 6/4/2014
Page No : 2

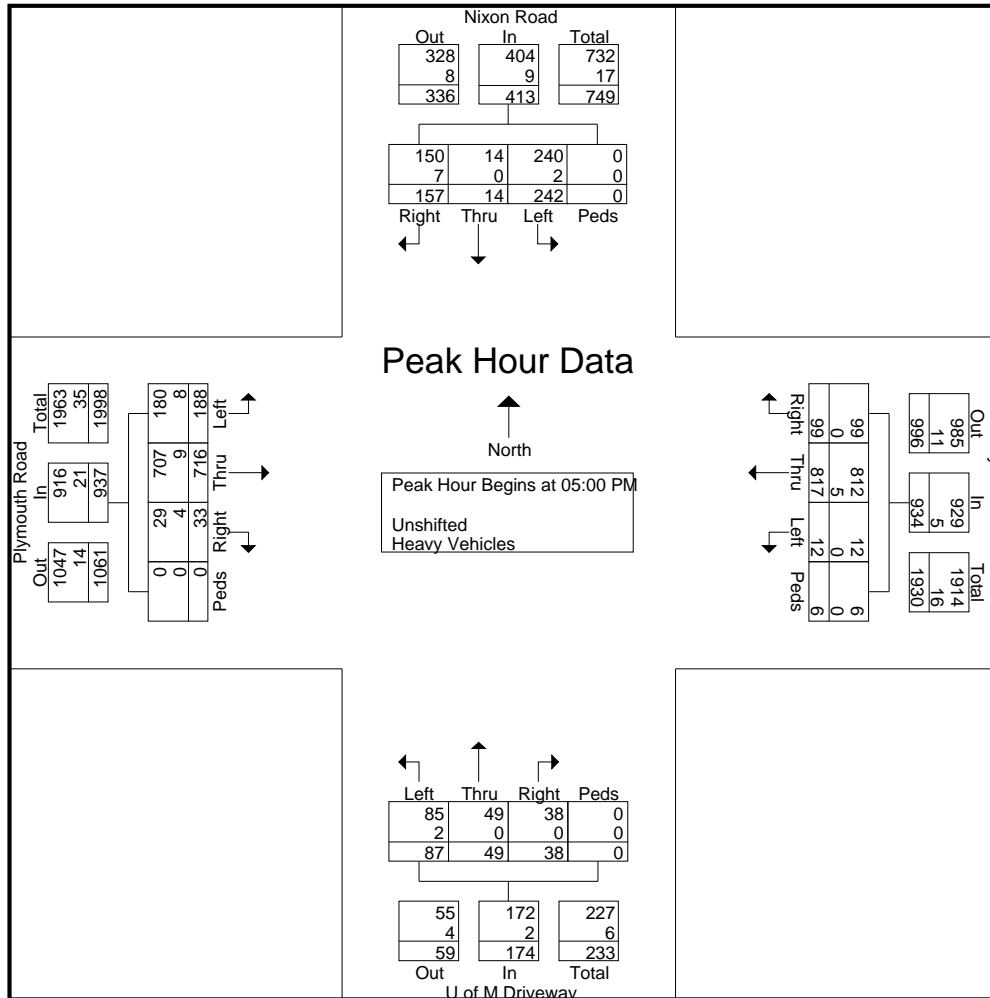

Traffic Engineering Associates, Inc.

PO Box 100
Saranac, MI 4888
517-627-6028

Location: Nixon Rd at Huron Pkwy
City/County: Ann Arbor, Washtenaw Co
Weather: Warm
Counted By: CW

File Name : nixon at huron pkwy am pk
Site Code : 60680830
Start Date : 6/4/2014
Page No : 1

Groups Printed- Cars - HV

Start Time	Nixon Rd From North					Huron Pkwy From East					Nixon Rd From South					Huron Pkwy From West					Int. Total
	Left	Thru	Right	Peds	App. Total	Left	Thru	Right	Peds	App. Total	Left	Thru	Right	Peds	App. Total	Left	Thru	Right	Peds	App. Total	
08:00 AM	71	72	11	1	155	8	25	33	2	68	4	31	12	0	47	3	12	7	5	27	297
08:15 AM	56	59	14	1	130	4	22	37	1	64	9	34	10	2	55	6	12	8	2	28	277
08:30 AM	75	73	17	1	166	3	35	55	2	95	10	33	12	1	56	4	21	5	7	37	354
08:45 AM	91	98	8	0	197	4	50	29	5	88	11	30	9	2	52	3	21	10	6	40	377
Total	293	302	50	3	648	19	132	154	10	315	34	128	43	5	210	16	66	30	20	132	1305
Grand Total	293	302	50	3	648	19	132	154	10	315	34	128	43	5	210	16	66	30	20	132	1305
Apprch %	45.2	46.6	7.7	0.5		6	41.9	48.9	3.2		16.2	61	20.5	2.4		12.1	50	22.7	15.2		
Total %	22.5	23.1	3.8	0.2	49.7	1.5	10.1	11.8	0.8	24.1	2.6	9.8	3.3	0.4	16.1	1.2	5.1	2.3	1.5	10.1	
Cars	281	294	50	3	628	14	132	150	10	306	31	122	39	5	197	15	63	28	20	126	1257
% Cars	95.9	97.4	100	100	96.9	73.7	100	97.4	100	97.1	91.2	95.3	90.7	100	93.8	93.8	95.5	93.3	100	95.5	96.3
HV	12	8	0	0	20	5	0	4	0	9	3	6	4	0	13	1	3	2	0	6	48
% HV	4.1	2.6	0	0	3.1	26.3	0	2.6	0	2.9	8.8	4.7	9.3	0	6.2	6.2	4.5	6.7	0	4.5	3.7

Start Time	Nixon Rd From North					Huron Pkwy From East					Nixon Rd From South					Huron Pkwy From West					Int. Total
	Left	Thru	Right	Peds	App. Total	Left	Thru	Right	Peds	App. Total	Left	Thru	Right	Peds	App. Total	Left	Thru	Right	Peds	App. Total	
Peak Hour Analysis From 08:00 AM to 08:45 AM - Peak 1 of 1																					
Peak Hour for Entire Intersection Begins at 08:00 AM																					
08:00 AM	71	72	11	1	155	8	25	33	2	68	4	31	12	0	47	3	12	7	5	27	297
08:15 AM	56	59	14	1	130	4	22	37	1	64	9	34	10	2	55	6	12	8	2	28	277
08:30 AM	75	73	17	1	166	3	35	55	2	95	10	33	12	1	56	4	21	5	7	37	354
08:45 AM	91	98	8	0	197	4	50	29	5	88	11	30	9	2	52	3	21	10	6	40	377
Total Volume	293	302	50	3	648	19	132	154	10	315	34	128	43	5	210	16	66	30	20	132	1305
% App. Total	45.2	46.6	7.7	0.5		6	41.9	48.9	3.2		16.2	61	20.5	2.4		12.1	50	22.7	15.2		
PHF	.805	.770	.735	.750	.822	.594	.660	.700	.500	.829	.773	.941	.896	.625	.938	.667	.786	.750	.714	.825	.865

Traffic Engineering Associates, Inc.

PO Box 100
Saranac, MI 4888
517-627-6028

Location: Nixon Rd at Huron Pkwy
City/County: Ann Arbor, Washtenaw Co
Weather: Warm
Counted By: CW

File Name : nixon at huron pkwy am pk
Site Code : 60680830
Start Date : 6/4/2014
Page No : 2

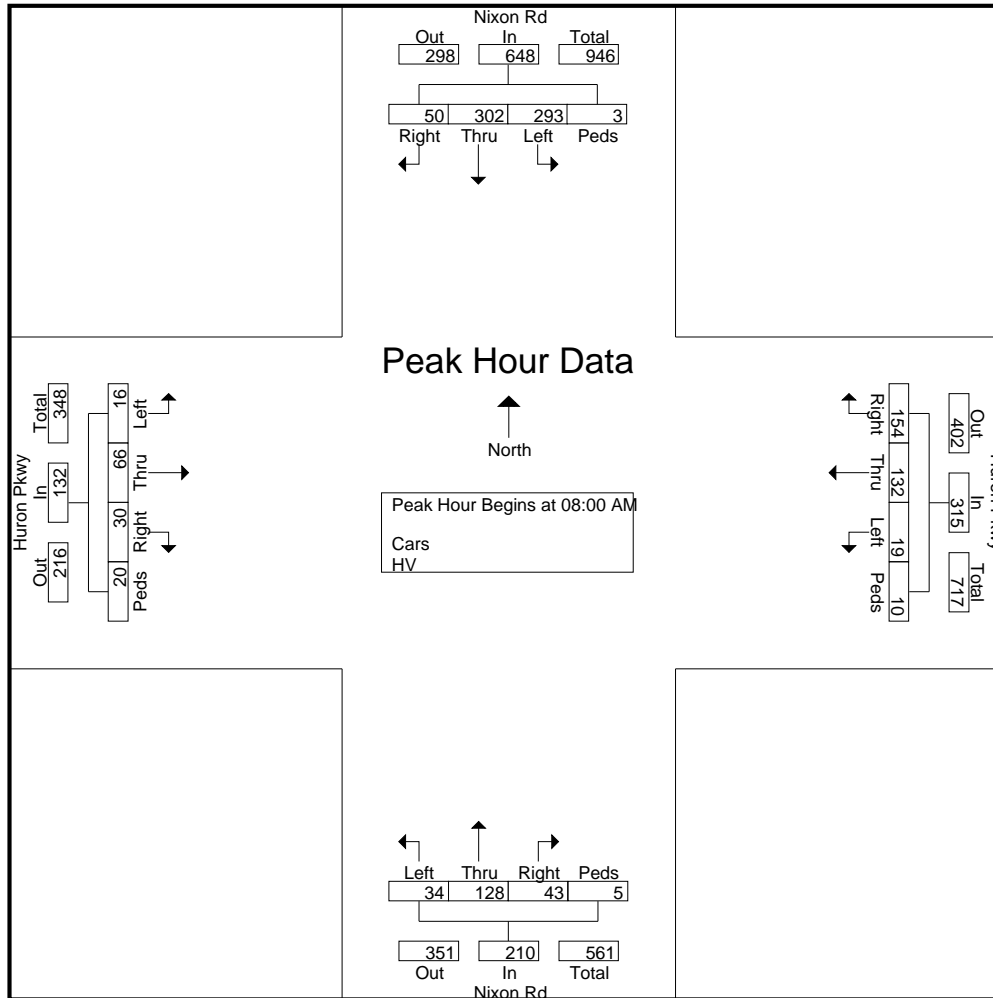

Traffic Engineering Associates, Inc.

PO Box 100
Saranac, MI 4888
517-627-6028

Location: Nixon Rd at Huron Pkwy
City/County: Ann Arbor, Washtenaw Co
Weather: Warm, raining
Counted By: CW

File Name : nixon at huron pkwy pm pk
Site Code : 05008069
Start Date : 6/4/2014
Page No : 1

Groups Printed- Cars - HV

Start Time	Nixon Rd From North					Huron Pkwy From East					Nixon Rd From South					Huron Pkwy From West					Int. Total
	Left	Thru	Right	Peds	App. Total	Left	Thru	Right	Peds	App. Total	Left	Thru	Right	Peds	App. Total	Left	Thru	Right	Peds	App. Total	
05:00 PM	36	53	7	1	97	12	13	63	3	91	11	79	34	1	125	19	39	14	10	82	395
05:15 PM	33	58	5	2	98	10	22	71	4	107	8	83	20	1	112	17	26	11	3	57	374
05:30 PM	33	45	6	0	84	16	24	68	2	110	11	83	14	5	113	18	58	8	5	89	396
05:45 PM	37	61	6	1	105	10	30	62	1	103	13	94	17	4	128	15	35	18	8	76	412
Total	139	217	24	4	384	48	89	264	10	411	43	339	85	11	478	69	158	51	26	304	1577
Grand Total	139	217	24	4	384	48	89	264	10	411	43	339	85	11	478	69	158	51	26	304	1577
Apprch %	36.2	56.5	6.2	1		11.7	21.7	64.2	2.4		9	70.9	17.8	2.3		22.7	52	16.8	8.6		
Total %	8.8	13.8	1.5	0.3	24.4	3	5.6	16.7	0.6	26.1	2.7	21.5	5.4	0.7	30.3	4.4	10	3.2	1.6	19.3	
Cars	139	215	24	4	382	45	89	263	10	407	41	336	80	11	468	69	158	49	26	302	1559
% Cars	100	99.1	100	100	99.5	93.8	100	99.6	100	99	95.3	99.1	94.1	100	97.9	100	100	96.1	100	99.3	98.9
HV	0	2	0	0	2	3	0	1	0	4	2	3	5	0	10	0	0	2	0	2	18
% HV	0	0.9	0	0	0.5	6.2	0	0.4	0	1	4.7	0.9	5.9	0	2.1	0	0	3.9	0	0.7	1.1

Start Time	Nixon Rd From North					Huron Pkwy From East					Nixon Rd From South					Huron Pkwy From West					Int. Total
	Left	Thru	Right	Peds	App. Total	Left	Thru	Right	Peds	App. Total	Left	Thru	Right	Peds	App. Total	Left	Thru	Right	Peds	App. Total	
Peak Hour Analysis From 05:00 PM to 05:45 PM - Peak 1 of 1																					
Peak Hour for Entire Intersection Begins at 05:00 PM																					
05:00 PM	36	53	7	1	97	12	13	63	3	91	11	79	34	1	125	19	39	14	10	82	395
05:15 PM	33	58	5	2	98	10	22	71	4	107	8	83	20	1	112	17	26	11	3	57	374
05:30 PM	33	45	6	0	84	16	24	68	2	110	11	83	14	5	113	18	58	8	5	89	396
05:45 PM	37	61	6	1	105	10	30	62	1	103	13	94	17	4	128	15	35	18	8	76	412
Total Volume	139	217	24	4	384	48	89	264	10	411	43	339	85	11	478	69	158	51	26	304	1577
% App. Total	36.2	56.5	6.2	1		11.7	21.7	64.2	2.4		9	70.9	17.8	2.3		22.7	52	16.8	8.6		
PHF	.939	.889	.857	.500	.914	.750	.742	.930	.625	.934	.827	.902	.625	.550	.934	.908	.681	.708	.650	.854	.957

Traffic Engineering Associates, Inc.

PO Box 100
Saranac, MI 4888
517-627-6028

Location: Nixon Rd at Huron Pkwy
City/County: Ann Arbor, Washtenaw Co
Weather: Warm, raining
Counted By: CW

File Name : nixon at huron pkwy pm pk
Site Code : 05008069
Start Date : 6/4/2014
Page No : 2

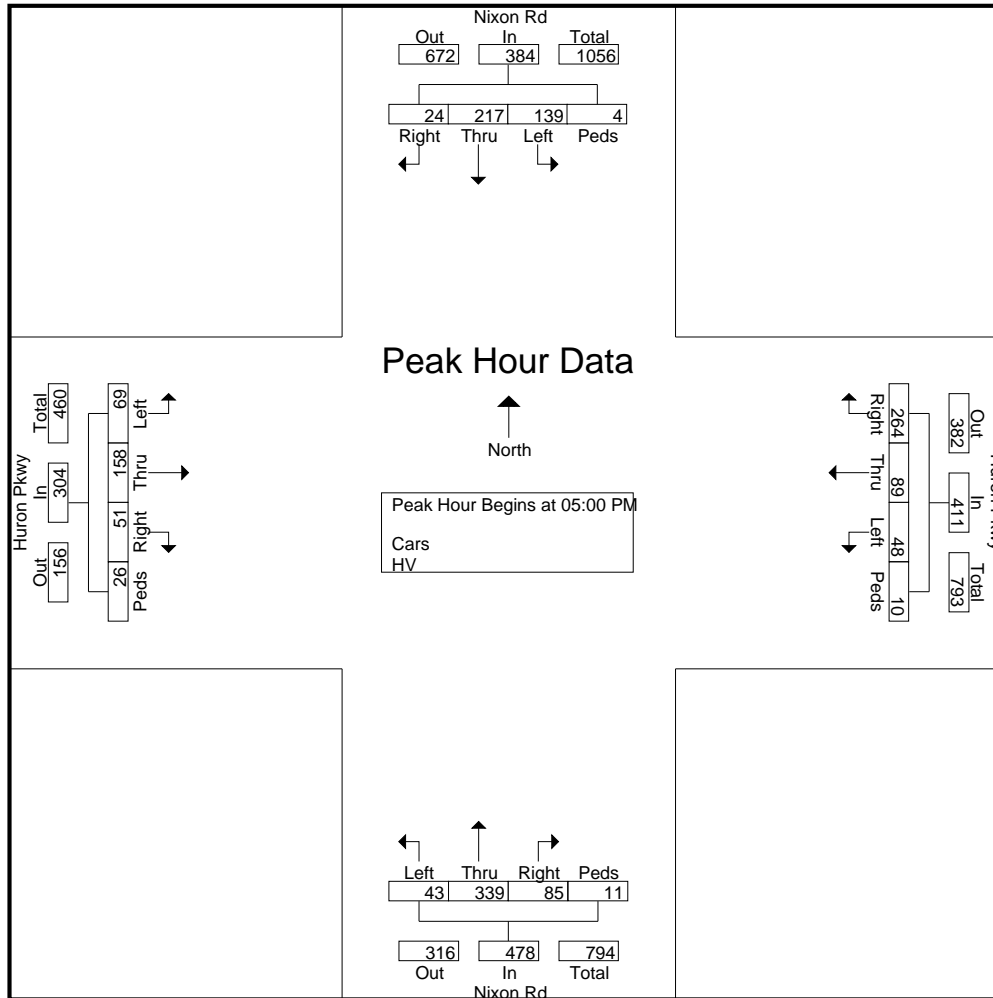

Traffic Engineering Associates, Inc.

PO Box 100
Saranac, Michigan 48881
517-627-6028

Location: Nixon Rd. & Barclays Way
City/County: City of Ann Arbor
Weather: Cloudy
Counted By: JJ

File Name : Nixon & Barclays Way AM
Site Code : 11051402
Start Date : 11/5/2014
Page No : 1

Groups Printed- Passenger Vehicles - Heavy Vehicles

Start Time	Nixon Road From North					Barclays Way From East					Nixon Road From South					From West					Int. Total
	Left	Thru	Right	Peds	App. Total	Left	Thru	Right	Peds	App. Total	Left	Thru	Right	Peds	App. Total	Left	Thru	Right	Peds	App. Total	
07:00 AM	0	59	0	0	59	9	0	1	0	10	0	15	0	0	15	0	0	0	0	0	84
07:15 AM	0	95	0	0	95	28	0	3	0	31	0	17	2	0	19	0	0	0	0	0	145
07:30 AM	0	107	0	0	107	26	0	2	0	28	1	26	7	1	35	0	0	0	0	0	170
07:45 AM	0	113	0	0	113	25	0	3	0	28	0	30	5	0	35	0	0	0	0	0	176
Total	0	374	0	0	374	88	0	9	0	97	1	88	14	1	104	0	0	0	0	0	575
08:00 AM	1	111	0	0	112	16	0	2	0	18	0	18	3	0	21	0	0	0	0	0	151
08:15 AM	0	105	0	0	105	21	0	2	0	23	0	17	3	0	20	0	0	0	0	0	148
08:30 AM	1	101	0	0	102	24	0	2	0	26	0	20	7	0	27	0	0	0	0	0	155
08:45 AM	0	66	0	0	66	13	0	0	0	13	0	22	12	0	34	0	0	0	0	0	113
Total	2	383	0	0	385	74	0	6	0	80	0	77	25	0	102	0	0	0	0	0	567
Grand Total	2	757	0	0	759	162	0	15	0	177	1	165	39	1	206	0	0	0	0	0	1142
Apprch %	0.3	99.7	0	0		91.5	0	8.5	0		0.5	80.1	18.9	0.5		0	0	0	0	0	
Total %	0.2	66.3	0	0	66.5	14.2	0	1.3	0	15.5	0.1	14.4	3.4	0.1	18	0	0	0	0	0	
Passenger Vehicles	2	738	0	0	740	160	0	15	0	175	1	159	36	1	197	0	0	0	0	0	1112
% Passenger Vehicles	100	97.5	0	0	97.5	98.8	0	100	0	98.9	100	96.4	92.3	100	95.6	0	0	0	0	0	97.4
Heavy Vehicles	0	19	0	0	19	2	0	0	0	2	0	6	3	0	9	0	0	0	0	0	30
% Heavy Vehicles	0	2.5	0	0	2.5	1.2	0	0	0	1.1	0	3.6	7.7	0	4.4	0	0	0	0	0	2.6

Start Time	Nixon Road From North					Barclays Way From East					Nixon Road From South					From West					Int. Total
	Left	Thru	Right	Peds	App. Total	Left	Thru	Right	Peds	App. Total	Left	Thru	Right	Peds	App. Total	Left	Thru	Right	Peds	App. Total	
Peak Hour Analysis From 07:00 AM to 08:45 AM - Peak 1 of 1																					
Peak Hour for Entire Intersection Begins at 07:30 AM																					
07:30 AM	0	107	0	0	107	26	0	2	0	28	1	26	7	1	35	0	0	0	0	0	170
07:45 AM	0	113	0	0	113	25	0	3	0	28	0	30	5	0	35	0	0	0	0	0	176
08:00 AM	1	111	0	0	112	16	0	2	0	18	0	18	3	0	21	0	0	0	0	0	151
08:15 AM	0	105	0	0	105	21	0	2	0	23	0	17	3	0	20	0	0	0	0	0	148
Total Volume	1	436	0	0	437	88	0	9	0	97	1	91	18	1	111	0	0	0	0	0	645
% App. Total	0.2	99.8	0	0		90.7	0	9.3	0		0.9	82	16.2	0.9		0	0	0	0	0	
PHF	.250	.965	.000	.000	.967	.846	.000	.750	.000	.866	.250	.758	.643	.250	.793	.000	.000	.000	.000	.000	.916
Passenger Vehicles	1	425	0	0	426	87	0	9	0	96	1	90	16	1	108	0	0	0	0	0	630
% Passenger Vehicles	100	97.5	0	0	97.5	98.9	0	100	0	99.0	100	98.9	88.9	100	97.3	0	0	0	0	0	97.7
Heavy Vehicles	0	11	0	0	11	1	0	0	0	1	0	1	2	0	3	0	0	0	0	0	15
% Heavy Vehicles	0	2.5	0	0	2.5	1.1	0	0	0	1.0	0	1.1	11.1	0	2.7	0	0	0	0	0	2.3

Traffic Engineering Associates, Inc.

PO Box 100
Saranac, Michigan 48881
517-627-6028

Location: Nixon Rd. & Barclays Way
City/County: City of Ann Arbor
Weather: Cloudy
Counted By: JJ

File Name : Nixon & Barclays Way AM
Site Code : 11051402
Start Date : 11/5/2014
Page No : 2

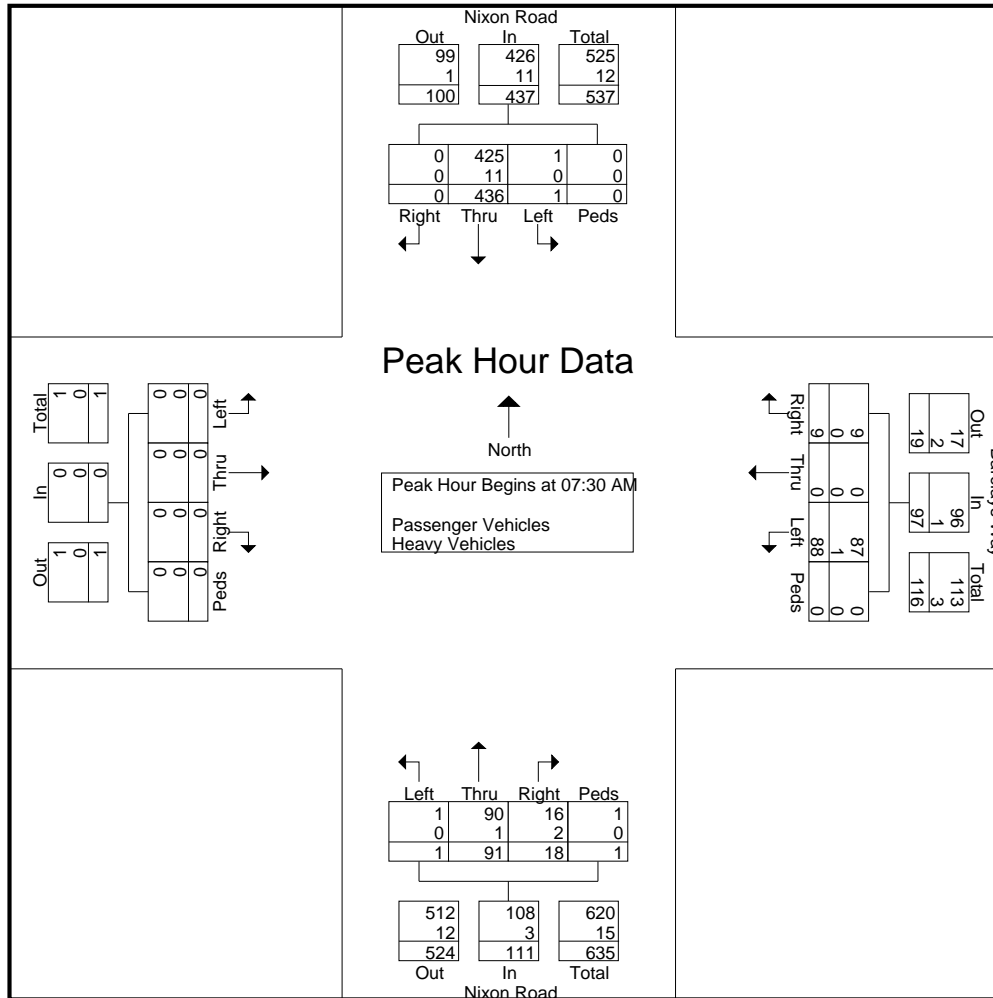

Traffic Engineering Associates, Inc.

PO Box 100
Saranac, Michigan 48881
517-627-6028

Location: Nixon Rd. & Barclays Way
City/County: City of Ann Arbor
Weather: Cloudy
Counted By: JJ

File Name : Nixon & Barclays Way PM
Site Code : 11051401
Start Date : 11/5/2014
Page No : 1

Groups Printed- Passenber Vehicles - Heavy Vehicles

Start Time	Nixon Road From North					Barclays Way From East					Nixon Road From South					From West					Int. Total
	Left	Thru	Right	Peds	App. Total	Left	Thru	Right	Peds	App. Total	Left	Thru	Right	Peds	App. Total	Left	Thru	Right	Peds	App. Total	
04:00 PM	1	22	0	0	23	9	0	0	0	9	0	66	15	0	81	0	0	0	0	0	113
04:15 PM	3	33	0	0	36	5	0	0	0	5	0	94	9	4	107	0	0	0	0	0	148
04:30 PM	1	22	0	0	23	5	0	0	0	5	0	92	11	3	106	0	0	0	0	0	134
04:45 PM	1	31	0	0	32	9	0	0	0	9	0	122	13	0	135	0	0	0	0	0	176
Total	6	108	0	0	114	28	0	0	0	28	0	374	48	7	429	0	0	0	0	0	571
05:00 PM	0	31	0	0	31	4	0	0	0	4	0	113	18	0	131	0	0	0	0	0	166
05:15 PM	3	24	0	0	27	12	0	0	0	12	0	123	25	0	148	0	0	0	0	0	187
05:30 PM	1	25	0	0	26	17	0	0	0	17	0	109	25	0	134	0	0	0	0	0	177
05:45 PM	0	26	0	0	26	7	0	0	0	7	0	76	32	0	108	0	0	0	0	0	141
Total	4	106	0	0	110	40	0	0	0	40	0	421	100	0	521	0	0	0	0	0	671
Grand Total	10	214	0	0	224	68	0	0	0	68	0	795	148	7	950	0	0	0	0	0	1242
Apprch %	4.5	95.5	0	0		100	0	0	0		0	83.7	15.6	0.7		0	0	0	0		
Total %	0.8	17.2	0	0	18	5.5	0	0	0	5.5	0	64	11.9	0.6	76.5	0	0	0	0	0	
Passenber Vehicles	10	210	0	0	220	67	0	0	0	67	0	787	147	7	941	0	0	0	0	0	1228
% Passenber Vehicles	100	98.1	0	0	98.2	98.5	0	0	0	98.5	0	99	99.3	100	99.1	0	0	0	0	0	98.9
Heavy Vehicles	0	4	0	0	4	1	0	0	0	1	0	8	1	0	9	0	0	0	0	0	14
% Heavy Vehicles	0	1.9	0	0	1.8	1.5	0	0	0	1.5	0	1	0.7	0	0.9	0	0	0	0	0	1.1

Start Time	Nixon Road From North					Barclays Way From East					Nixon Road From South					From West					Int. Total
	Left	Thru	Right	Peds	App. Total	Left	Thru	Right	Peds	App. Total	Left	Thru	Right	Peds	App. Total	Left	Thru	Right	Peds	App. Total	
Peak Hour Analysis From 04:00 PM to 05:45 PM - Peak 1 of 1																					
Peak Hour for Entire Intersection Begins at 04:45 PM																					
04:45 PM	1	31	0	0	32	9	0	0	0	9	0	122	13	0	135	0	0	0	0	0	176
05:00 PM	0	31	0	0	31	4	0	0	0	4	0	113	18	0	131	0	0	0	0	0	166
05:15 PM	3	24	0	0	27	12	0	0	0	12	0	123	25	0	148	0	0	0	0	0	187
05:30 PM	1	25	0	0	26	17	0	0	0	17	0	109	25	0	134	0	0	0	0	0	177
Total Volume	5	111	0	0	116	42	0	0	0	42	0	467	81	0	548	0	0	0	0	0	706
% App. Total	4.3	95.7	0	0		100	0	0	0		0	85.2	14.8	0		0	0	0	0		
PHF	.417	.895	.000	.000	.906	.618	.000	.000	.000	.618	.000	.949	.810	.000	.926	.000	.000	.000	.000	.000	.944
Passenber Vehicles	5	110	0	0	115	42	0	0	0	42	0	463	81	0	544	0	0	0	0	0	701
% Passenber Vehicles	100	99.1	0	0	99.1	100	0	0	0	100	0	99.1	100	0	99.3	0	0	0	0	0	99.3
Heavy Vehicles	0	1	0	0	1	0	0	0	0	0	0	4	0	0	4	0	0	0	0	0	5
% Heavy Vehicles	0	0.9	0	0	0.9	0	0	0	0	0	0	0.9	0	0	0.7	0	0	0	0	0	0.7

Traffic Engineering Associates, Inc.

PO Box 100
Saranac, Michigan 48881
517-627-6028

Location: Nixon Rd. & Barclays Way
City/County: City of Ann Arbor
Weather: Cloudy
Counted By: JJ

File Name : Nixon & Barclays Way PM
Site Code : 11051401
Start Date : 11/5/2014
Page No : 2

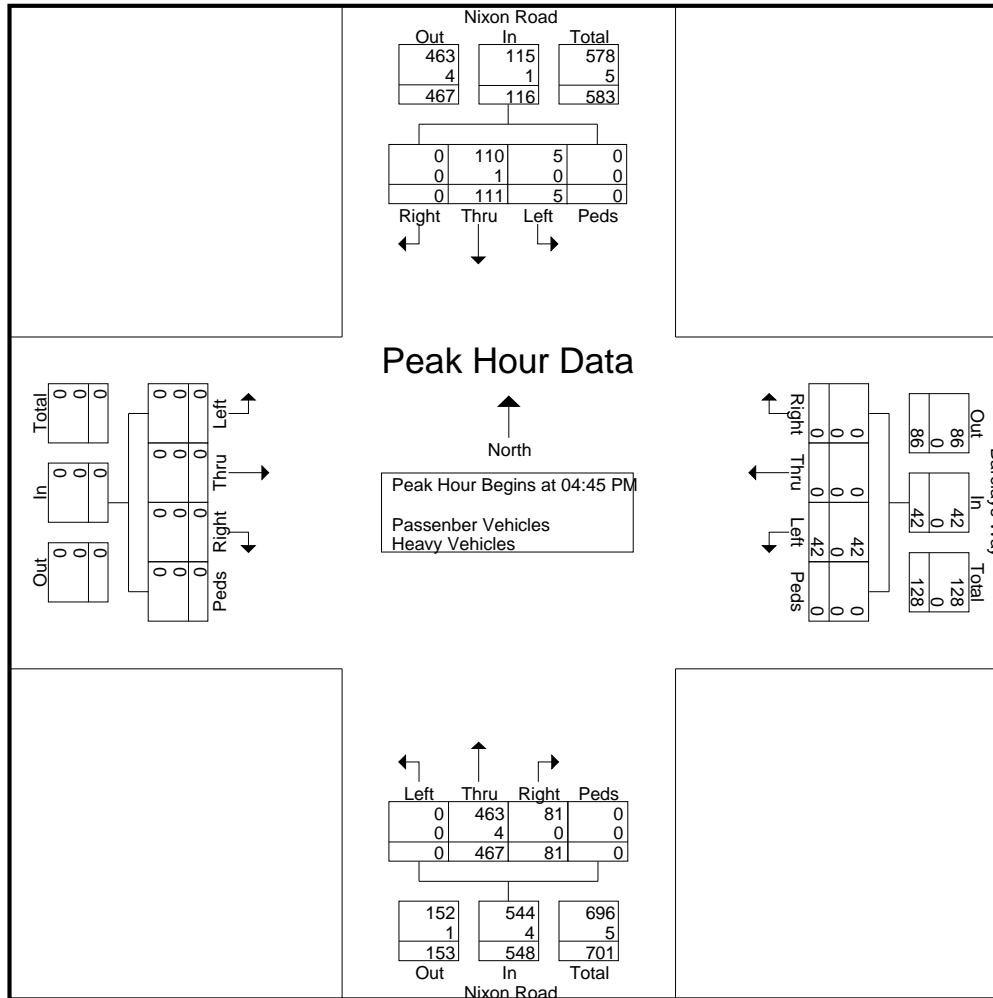

Traffic Engineering Associates, Inc.

PO Box 100
Saranac, Michigan 48881
517-627-6028

Location: Nixon Rd. & Haverhill Court
City/County: City of Ann Arbor
Weather: Cloudy
Counted By: JJ

File Name : Nixon & Haverhill Court AM
Site Code : 11061402
Start Date : 11/6/2014
Page No : 1

Groups Printed- Passenger Vehicles - Heavy Vehicles

Start Time	Nixon Road From North					Haverhill Court From East					Nixon Road From South					From West					Int. Total
	Left	Thru	Right	Peds	App. Total	Left	Thru	Right	Peds	App. Total	Left	Thru	Right	Peds	App. Total	Left	Thru	Right	Peds	App. Total	
07:00 AM	0	109	0	0	109	1	0	0	0	1	0	17	0	0	17	0	0	0	0	0	127
07:15 AM	0	141	0	0	141	4	0	1	0	5	0	20	0	0	20	0	0	0	0	0	166
07:30 AM	0	154	0	0	154	2	0	0	0	2	0	49	0	0	49	0	0	0	0	0	205
07:45 AM	0	165	0	0	165	1	0	0	0	1	0	53	0	0	53	0	0	0	0	0	219
Total	0	569	0	0	569	8	0	1	0	9	0	139	0	0	139	0	0	0	0	0	717
08:00 AM	0	139	0	0	139	0	0	1	0	1	0	73	0	0	73	0	0	0	0	0	213
08:15 AM	0	128	0	0	128	1	0	0	0	1	0	42	1	0	43	0	0	0	0	0	172
08:30 AM	0	175	0	0	175	2	0	1	0	3	0	42	0	1	43	0	0	0	0	0	221
08:45 AM	0	162	0	0	162	6	0	0	0	6	0	82	1	0	83	0	0	0	0	0	251
Total	0	604	0	0	604	9	0	2	0	11	0	239	2	1	242	0	0	0	0	0	857
Grand Total	0	1173	0	0	1173	17	0	3	0	20	0	378	2	1	381	0	0	0	0	0	1574
Apprch %	0	100	0	0		85	0	15	0		0	99.2	0.5	0.3		0	0	0	0		
Total %	0	74.5	0	0	74.5	1.1	0	0.2	0	1.3	0	24	0.1	0.1	24.2	0	0	0	0	0	
Passenger Vehicles	0	1138	0	0	1138	17	0	3	0	20	0	354	2	1	357	0	0	0	0	0	1515
% Passenger Vehicles	0	97	0	0	97	100	0	100	0	100	0	93.7	100	100	93.7	0	0	0	0	0	96.3
Heavy Vehicles	0	35	0	0	35	0	0	0	0	0	0	24	0	0	24	0	0	0	0	0	59
% Heavy Vehicles	0	3	0	0	3	0	0	0	0	0	0	6.3	0	0	6.3	0	0	0	0	0	3.7

Start Time	Nixon Road From North					Haverhill Court From East					Nixon Road From South					From West					Int. Total
	Left	Thru	Right	Peds	App. Total	Left	Thru	Right	Peds	App. Total	Left	Thru	Right	Peds	App. Total	Left	Thru	Right	Peds	App. Total	
Peak Hour Analysis From 07:00 AM to 08:45 AM - Peak 1 of 1																					
Peak Hour for Entire Intersection Begins at 08:00 AM																					
08:00 AM	0	139	0	0	139	0	0	1	0	1	0	73	0	0	73	0	0	0	0	0	213
08:15 AM	0	128	0	0	128	1	0	0	0	1	0	42	1	0	43	0	0	0	0	0	172
08:30 AM	0	175	0	0	175	2	0	1	0	3	0	42	0	1	43	0	0	0	0	0	221
08:45 AM	0	162	0	0	162	6	0	0	0	6	0	82	1	0	83	0	0	0	0	0	251
Total Volume	0	604	0	0	604	9	0	2	0	11	0	239	2	1	242	0	0	0	0	0	857
% App. Total	0	100	0	0		81.8	0	18.2	0		0	98.8	0.8	0.4		0	0	0	0		
PHF	.000	.863	.000	.000	.863	.375	.000	.500	.000	.458	.000	.729	.500	.250	.729	.000	.000	.000	.000	.000	.854
Passenger Vehicles	0	585	0	0	585	9	0	2	0	11	0	226	2	1	229	0	0	0	0	0	825
% Passenger Vehicles	0	96.9	0	0	96.9	100	0	100	0	100	0	94.6	100	100	94.6	0	0	0	0	0	96.3
Heavy Vehicles	0	19	0	0	19	0	0	0	0	0	0	13	0	0	13	0	0	0	0	0	32
% Heavy Vehicles	0	3.1	0	0	3.1	0	0	0	0	0	0	5.4	0	0	5.4	0	0	0	0	0	3.7

Traffic Engineering Associates, Inc.

PO Box 100
Saranac, Michigan 48881
517-627-6028

Location: Nixon Rd. & Haverhill Court
City/County: City of Ann Arbor
Weather: Cloudy
Counted By: JJ

File Name : Nixon & Haverhill Court AM
Site Code : 11061402
Start Date : 11/6/2014
Page No : 2

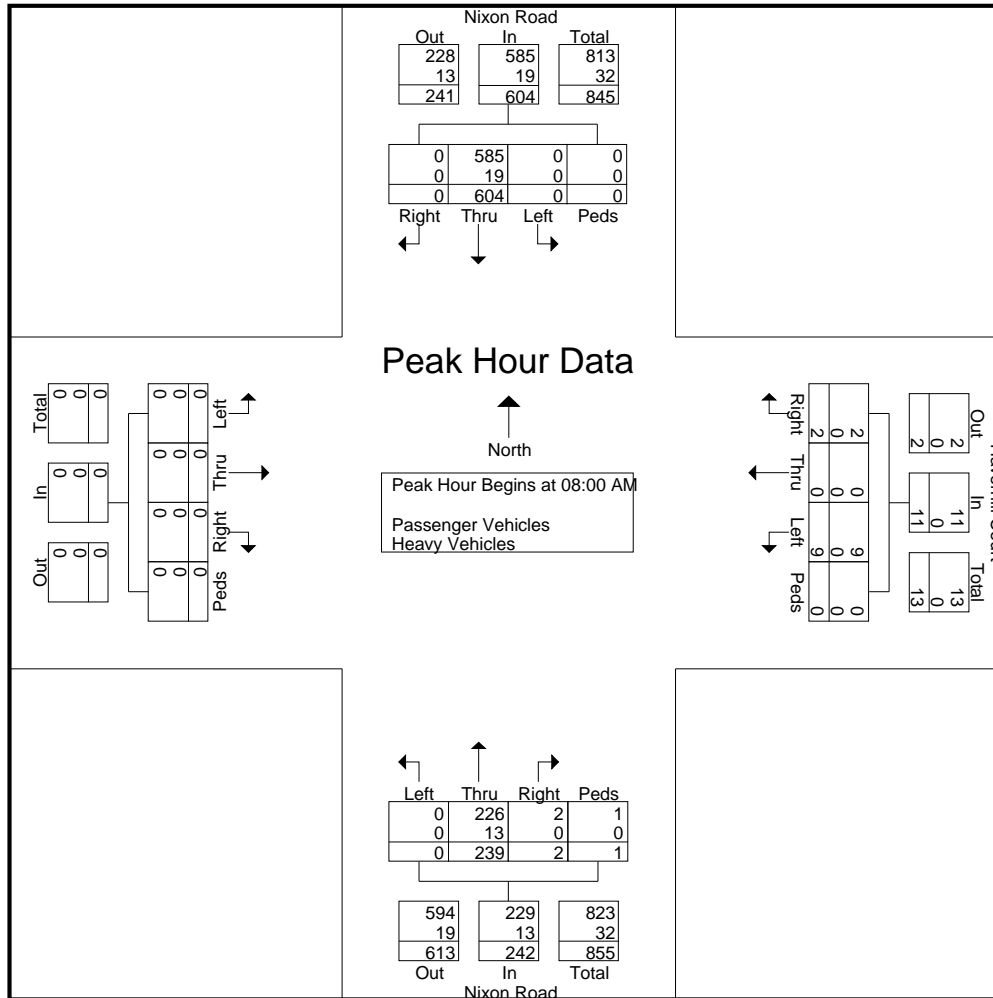

Traffic Engineering Associates, Inc.

PO Box 100
Saranac, Michigan 48881
517-627-6028

Location: Nixon Rd. & Haverhill Court
City/County: City of Ann Arbor
Weather: Cloudy
Counted By: JJ

File Name : Nixon & Haverhill Court PM
Site Code : 11061401
Start Date : 11/6/2014
Page No : 1

Groups Printed- Passenger Vehicles - Heavy Vehicles

Start Time	Nixon Road From North					Haverhill Court From East					Nixon Road From South					From West					Int. Total
	Left	Thru	Right	Peds	App. Total	Left	Thru	Right	Peds	App. Total	Left	Thru	Right	Peds	App. Total	Left	Thru	Right	Peds	App. Total	
04:00 PM	0	55	0	0	55	0	0	0	0	0	0	127	1	0	128	0	0	0	0	0	183
04:15 PM	1	59	0	0	60	1	0	0	0	1	0	112	1	0	113	0	0	0	0	0	174
04:30 PM	1	57	0	0	58	2	0	1	0	3	0	135	3	2	140	0	0	0	0	0	201
04:45 PM	1	54	0	0	55	0	0	1	0	1	0	125	2	1	128	0	0	0	0	0	184
Total	3	225	0	0	228	3	0	2	0	5	0	499	7	3	509	0	0	0	0	0	742
05:00 PM	2	69	0	0	71	1	0	0	0	1	0	118	1	1	120	0	0	0	0	0	192
05:15 PM	0	69	0	0	69	0	0	0	0	0	0	110	2	2	114	0	0	0	0	0	183
05:30 PM	1	61	0	0	62	5	0	0	0	5	0	113	2	0	115	0	0	0	0	0	182
05:45 PM	1	62	0	0	63	1	0	0	0	1	0	112	0	1	113	0	0	0	0	0	177
Total	4	261	0	0	265	7	0	0	0	7	0	453	5	4	462	0	0	0	0	0	734
Grand Total	7	486	0	0	493	10	0	2	0	12	0	952	12	7	971	0	0	0	0	0	1476
Apprch %	1.4	98.6	0	0		83.3	0	16.7	0		0	98	1.2	0.7		0	0	0	0	0	
Total %	0.5	32.9	0	0	33.4	0.7	0	0.1	0	0.8	0	64.5	0.8	0.5	65.8	0	0	0	0	0	
Passenger Vehicles	7	470	0	0	477	10	0	2	0	12	0	935	12	7	954	0	0	0	0	0	1443
% Passenger Vehicles	100	96.7	0	0	96.8	100	0	100	0	100	0	98.2	100	100	98.2	0	0	0	0	0	97.8
Heavy Vehicles	0	16	0	0	16	0	0	0	0	0	0	17	0	0	17	0	0	0	0	0	33
% Heavy Vehicles	0	3.3	0	0	3.2	0	0	0	0	0	0	1.8	0	0	1.8	0	0	0	0	0	2.2

Start Time	Nixon Road From North					Haverhill Court From East					Nixon Road From South					From West					Int. Total
	Left	Thru	Right	Peds	App. Total	Left	Thru	Right	Peds	App. Total	Left	Thru	Right	Peds	App. Total	Left	Thru	Right	Peds	App. Total	
Peak Hour Analysis From 04:00 PM to 05:45 PM - Peak 1 of 1																					
Peak Hour for Entire Intersection Begins at 04:30 PM																					
04:30 PM	1	57	0	0	58	2	0	1	0	3	0	135	3	2	140	0	0	0	0	0	201
04:45 PM	1	54	0	0	55	0	0	1	0	1	0	125	2	1	128	0	0	0	0	0	184
05:00 PM	2	69	0	0	71	1	0	0	0	1	0	118	1	1	120	0	0	0	0	0	192
05:15 PM	0	69	0	0	69	0	0	0	0	0	0	110	2	2	114	0	0	0	0	0	183
Total Volume	4	249	0	0	253	3	0	2	0	5	0	488	8	6	502	0	0	0	0	0	760
% App. Total	1.6	98.4	0	0		60	0	40	0		0	97.2	1.6	1.2		0	0	0	0	0	
PHF	.500	.902	.000	.000	.891	.375	.000	.500	.000	.417	.000	.904	.667	.750	.896	.000	.000	.000	.000	.000	.945
Passenger Vehicles	4	242	0	0	246	3	0	2	0	5	0	483	8	6	497	0	0	0	0	0	748
% Passenger Vehicles	100	97.2	0	0	97.2	100	0	100	0	100	0	99.0	100	100	99.0	0	0	0	0	0	98.4
Heavy Vehicles	0	7	0	0	7	0	0	0	0	0	0	5	0	0	5	0	0	0	0	0	12
% Heavy Vehicles	0	2.8	0	0	2.8	0	0	0	0	0	0	1.0	0	0	1.0	0	0	0	0	0	1.6

Traffic Engineering Associates, Inc.

PO Box 100
Saranac, Michigan 48881
517-627-6028

Location: Nixon Rd. & Haverhill Court
City/County: City of Ann Arbor
Weather: Cloudy
Counted By: JJ

File Name : Nixon & Haverhill Court PM
Site Code : 11061401
Start Date : 11/6/2014
Page No : 2

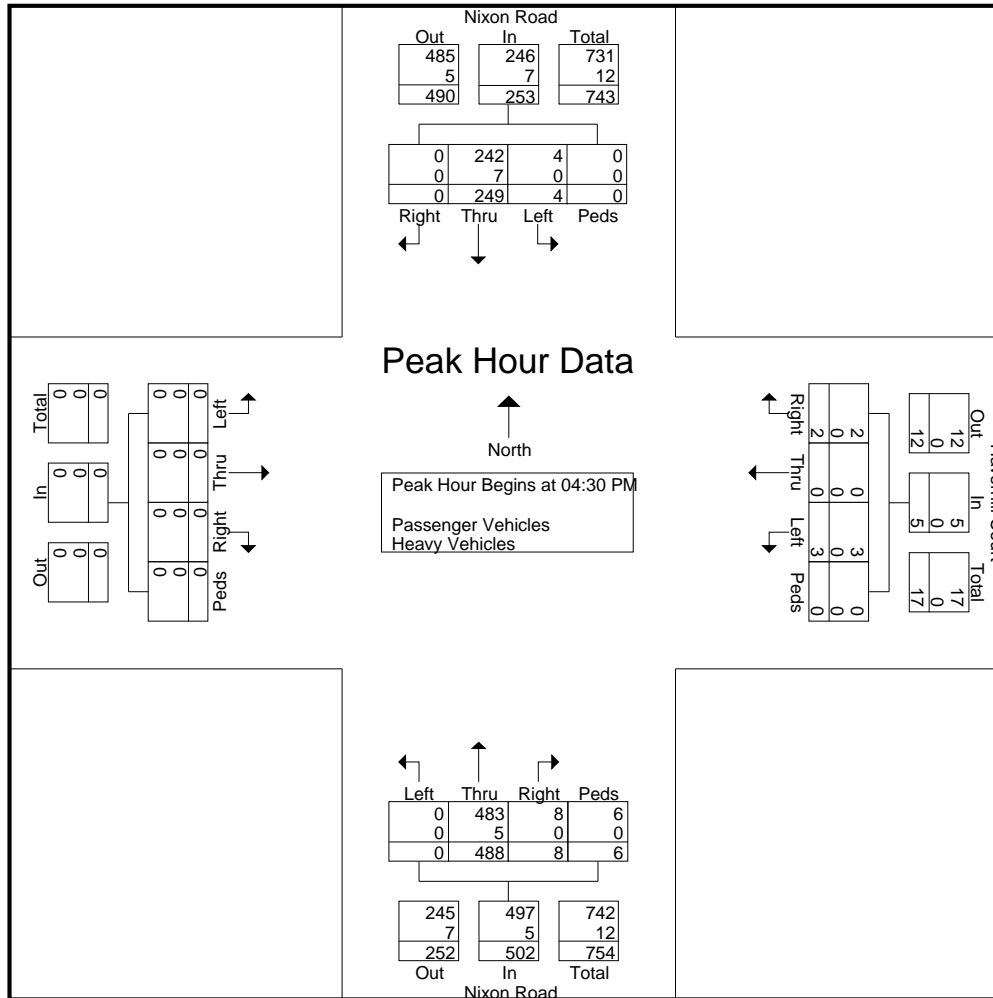

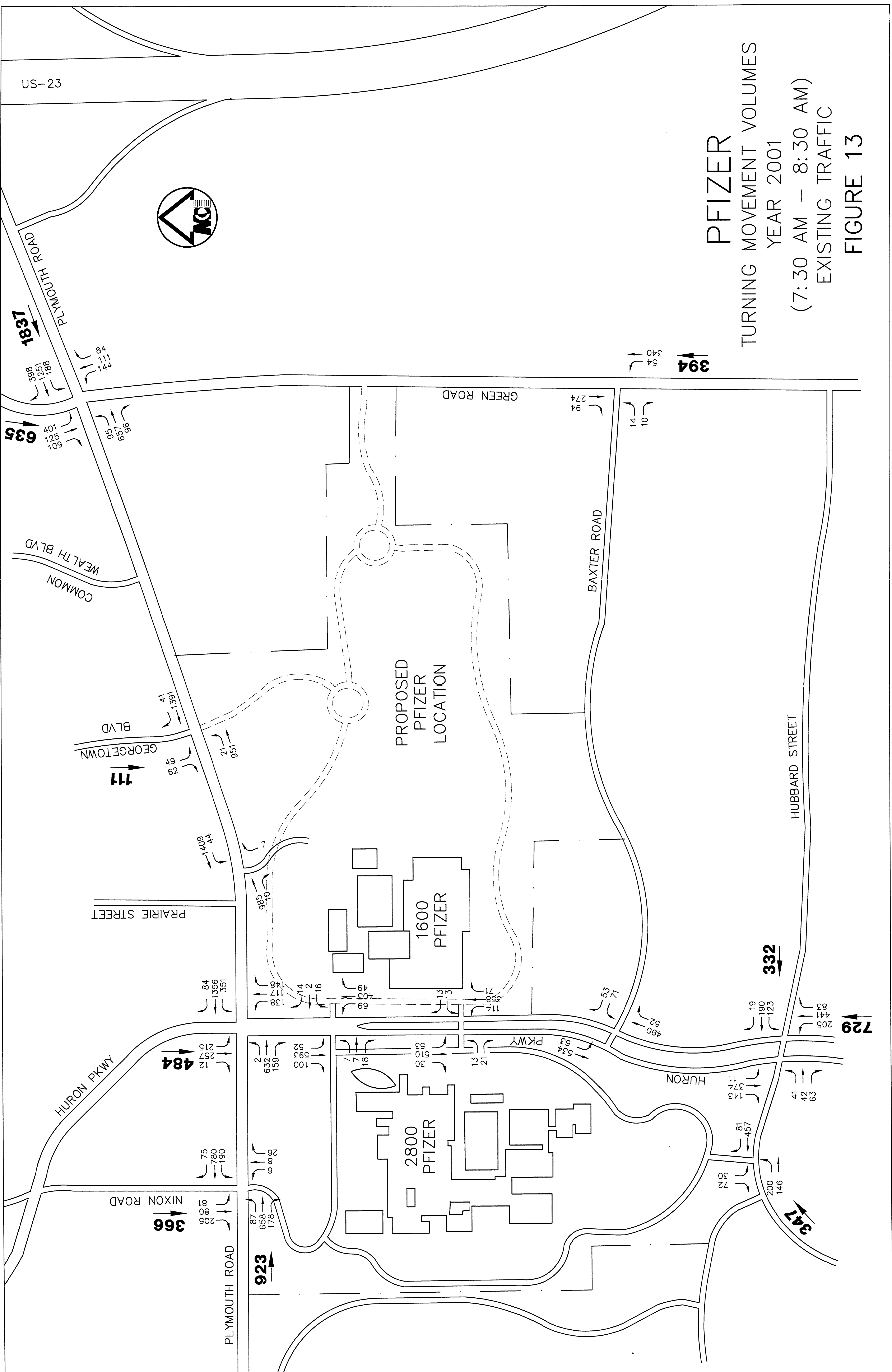

PFIZER
 TURNING MOVEMENT VOLUMES
 YEAR 2001
 (7:30 AM - 8:30 AM)
 EXISTING TRAFFIC
FIGURE 13

US-23

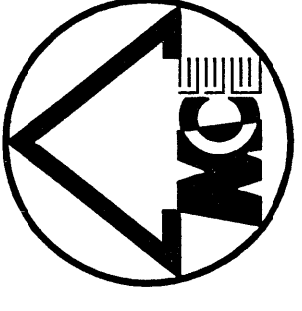

394
 54
 340

1837

635

WEALTH BLVD
 COMMON

111
 GEORGETOWN
 BLVD

PRAIRIE STREET

PROPOSED
 PFIZER
 LOCATION

1600
 PFIZER

2800
 PFIZER

BAXTER ROAD

HUBBARD STREET

HURON PKWY

484

366
 NIXON ROAD

PLYMOUTH ROAD

923

HURON
 PKWY

332

729

347

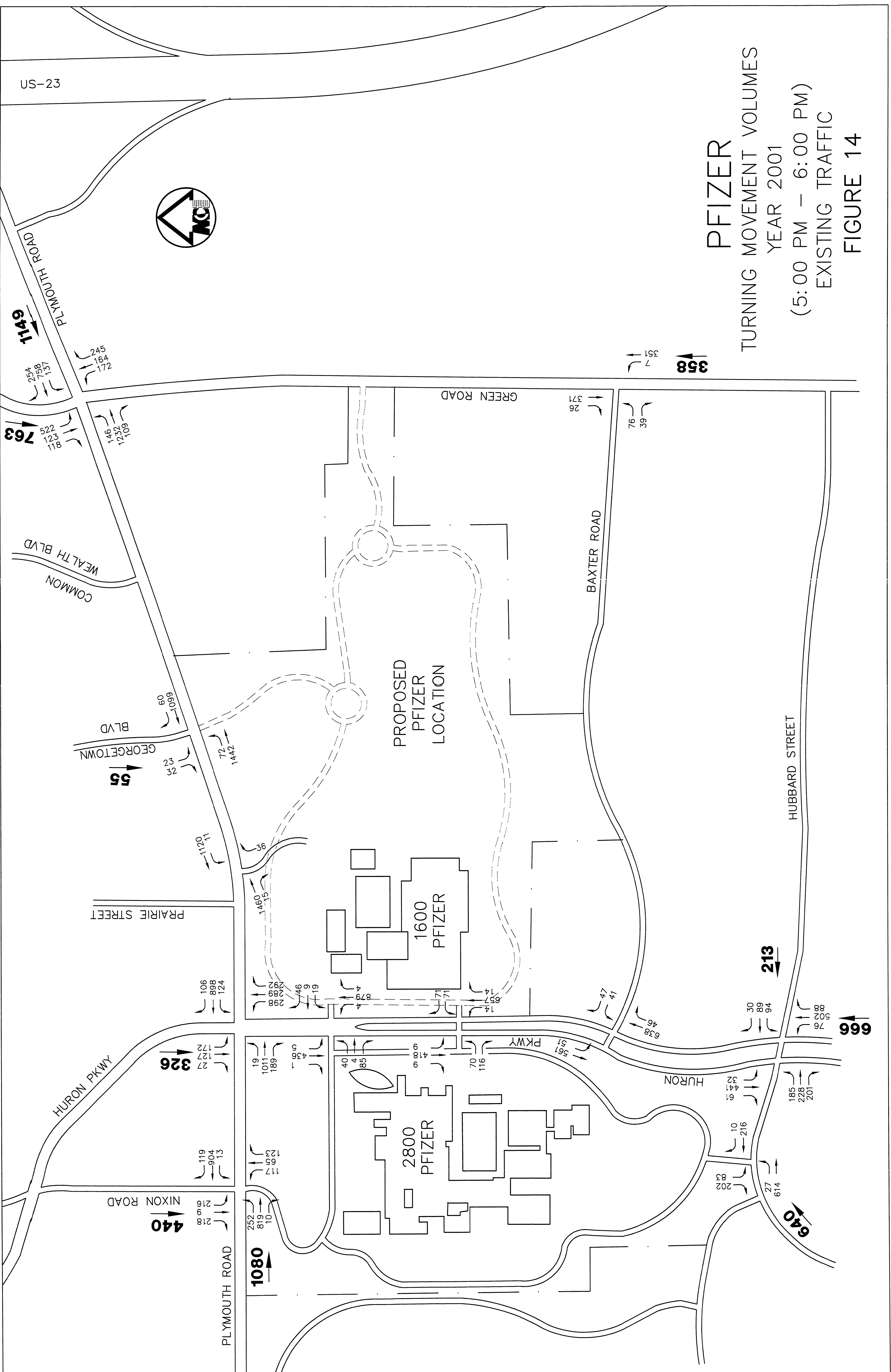

PFIZER
 TURNING MOVEMENT VOLUMES
 YEAR 2001
 (5:00 PM - 6:00 PM)
 EXISTING TRAFFIC
FIGURE 14

CensusViewer delivers detailed demographics and population statistics from the 2010 Census, 2000 Census, American Community Survey (ACS), registered voter files, commercial data sources and more.

Experience breakthrough technology for census data discovery, population analysis and visualization over Bing Maps. Visually "fly over" a state, viewing in great detail the census blocks, census tracts, cities, counties and various political districts in your selection or "zoom down" to the street level to get demographic statistics and information about the population in an individual census block or census tract.

Click on any map link to see our blazing-fast data visualization over Bing Maps in action. [Read more](#) about the unprecedented demographic insight and analytical power of CensusViewer interactive maps.

[CensusViewer maps, data and statistics pages for all states, counties and cities.](#)

Ann Arbor, Michigan - Overview	2010 Census		2000 Census		2000-2010 Change	
	Counts	Percentages	Counts	Percentages	Change	Percentages
Total Population						
Total Population	113,934	100.00%	114,701	100.00%	-767	-0.67%
Population by Race						
American Indian and Alaska native alone	301	0.26%	332	0.29%	-31	-9.34%
Asian alone	16,353	14.35%	13,605	11.86%	2,748	20.20%
Black or African American alone	8,804	7.73%	10,080	8.79%	-1,276	-12.66%
Native Hawaiian and Other Pacific native alone	38	0.03%	40	0.03%	-2	-5.00%
Some other race alone	1,172	1.03%	1,394	1.22%	-222	-15.93%
Two or more races	4,095	3.59%	3,494	3.05%	601	17.20%
White alone	83,171	73.00%	85,756	74.76%	-2,585	-3.01%
Population by Hispanic or Latino Origin (of any race)						
Persons Not of Hispanic or Latino Origin	109,268	95.90%	110,857	96.65%	-1,589	-1.43%
Persons of Hispanic or Latino Origin	4,666	4.10%	3,844	3.35%	822	21.38%
Population by Gender						
Female	57,779	50.71%	58,002	50.57%	-223	-0.38%
Male	56,155	49.29%	56,699	49.43%	-544	-0.96%
Population by Age						
Persons 0 to 4 years	4,868	4.27%	5,794	5.05%	-926	-15.98%
Persons 5 to 17 years	11,514	10.11%	13,469	11.74%	-1,955	-14.51%
Persons 18 to 64 years	86,940	76.31%	86,324	75.26%	616	0.71%
Persons 65 years and over	10,612	9.31%	9,114	7.95%	1,498	16.44%



State & County QuickFacts

Ann Arbor (city), Michigan

People QuickFacts	Ann Arbor	Michigan
Population, 2013 estimate	117,025	9,895,622
Population, 2012 estimate	116,328	9,882,519
Population, 2010 (April 1) estimates base	113,946	9,883,701
Population, percent change, April 1, 2010 to July 1, 2013	2.7%	0.1%
Population, percent change, April 1, 2010 to July 1, 2012	2.1%	0.0%
Population, 2010	113,934	9,883,640
Persons under 5 years, percent, 2010	4.3%	6.0%
Persons under 18 years, percent, 2010	14.4%	23.7%
Persons 65 years and over, percent, 2010	9.3%	13.8%
Female persons, percent, 2010	50.7%	50.9%

White alone, percent, 2010 (a)	73.0%	78.9%
Black or African American alone, percent, 2010 (a)	7.7%	14.2%
American Indian and Alaska Native alone, percent, 2010 (a)	0.3%	0.6%
Asian alone, percent, 2010 (a)	14.4%	2.4%
Native Hawaiian and Other Pacific Islander alone, percent, 2010 (a)	Z	0.0%
Two or More Races, percent, 2010	3.6%	2.3%
Hispanic or Latino, percent, 2010 (b)	4.1%	4.4%
White alone, not Hispanic or Latino, percent, 2010	70.4%	76.6%

Living in same house 1 year & over, percent, 2008-2012	64.4%	85.4%
Foreign born persons, percent, 2008-2012	18.2%	6.0%
Language other than English spoken at home, pct age 5+, 2008-2012	21.5%	9.0%
High school graduate or higher, percent of persons age 25+, 2008-2012	96.5%	88.7%
Bachelor's degree or higher, percent of persons age 25+, 2008-2012	70.3%	25.5%
Veterans, 2008-2012	4,040	692,582
Mean travel time to work (minutes), workers age 16+, 2008-2012	19.2	23.9
Housing units, 2010	49,789	4,532,233
Homeownership rate, 2008-2012	45.5%	72.8%
Housing units in multi-unit structures, percent, 2008-2012	48.1%	18.0%
Median value of owner-occupied housing units, 2008-2012	\$231,700	\$128,600
Households, 2008-2012	45,704	3,818,931
Persons per household, 2008-2012	2.23	2.53
Per capita money income in past 12 months (2012 dollars), 2008-2012	\$33,319	\$25,547
Median household income, 2008-2012	\$53,814	\$48,471
Persons below poverty level, percent, 2008-2012	21.9%	16.3%

Business QuickFacts	Ann Arbor	Michigan
Total number of firms, 2007	11,444	816,972
Black-owned firms, percent, 2007	5.7%	8.9%
American Indian- and Alaska Native-owned firms, percent, 2007	S	0.7%
Asian-owned firms, percent, 2007	6.0%	2.6%
Native Hawaiian and Other Pacific Islander-owned firms, percent, 2007	F	0.1%
Hispanic-owned firms, percent, 2007	S	1.3%
Women-owned firms, percent, 2007	34.4%	30.4%

Manufacturers shipments, 2007 (\$1000)	D 234,455,768	
Merchant wholesaler sales, 2007 (\$1000)	364,084	107,109,349
Retail sales, 2007 (\$1000)	1,467,205	109,102,594
Retail sales per capita, 2007	\$12,795	\$10,855
Accommodation and food services sales, 2007 (\$1000)	372,651	14,536,648

Geography QuickFacts	Ann Arbor Michigan	
Land area in square miles, 2010	27.83	56,538.90
Persons per square mile, 2010	4,093.9	174.8
FIPS Code	03000	26
Counties		

(a) Includes persons reporting only one race.
(b) Hispanics may be of any race, so also are included in applicable race categories.

D: Suppressed to avoid disclosure of confidential information
F: Fewer than 25 firms
FN: Footnote on this item for this area in place of data
NA: Not available
S: Suppressed; does not meet publication standards
X: Not applicable
Z: Value greater than zero but less than half unit of measure shown

Source U.S. Census Bureau: State and County QuickFacts. Data derived from Population Estimates, American Community Survey, Census of Population and Housing, County Business Patterns, Economic Census, Survey of Business Owners, Building Permits, Census of Governments
Last Revised: Wednesday, 11-Jun-2014 06:50:00 EDT

* Left Turn Lane Recommended

TWO-LANE HIGHWAYS WITH A POSTED SPEED OF 35 MPH

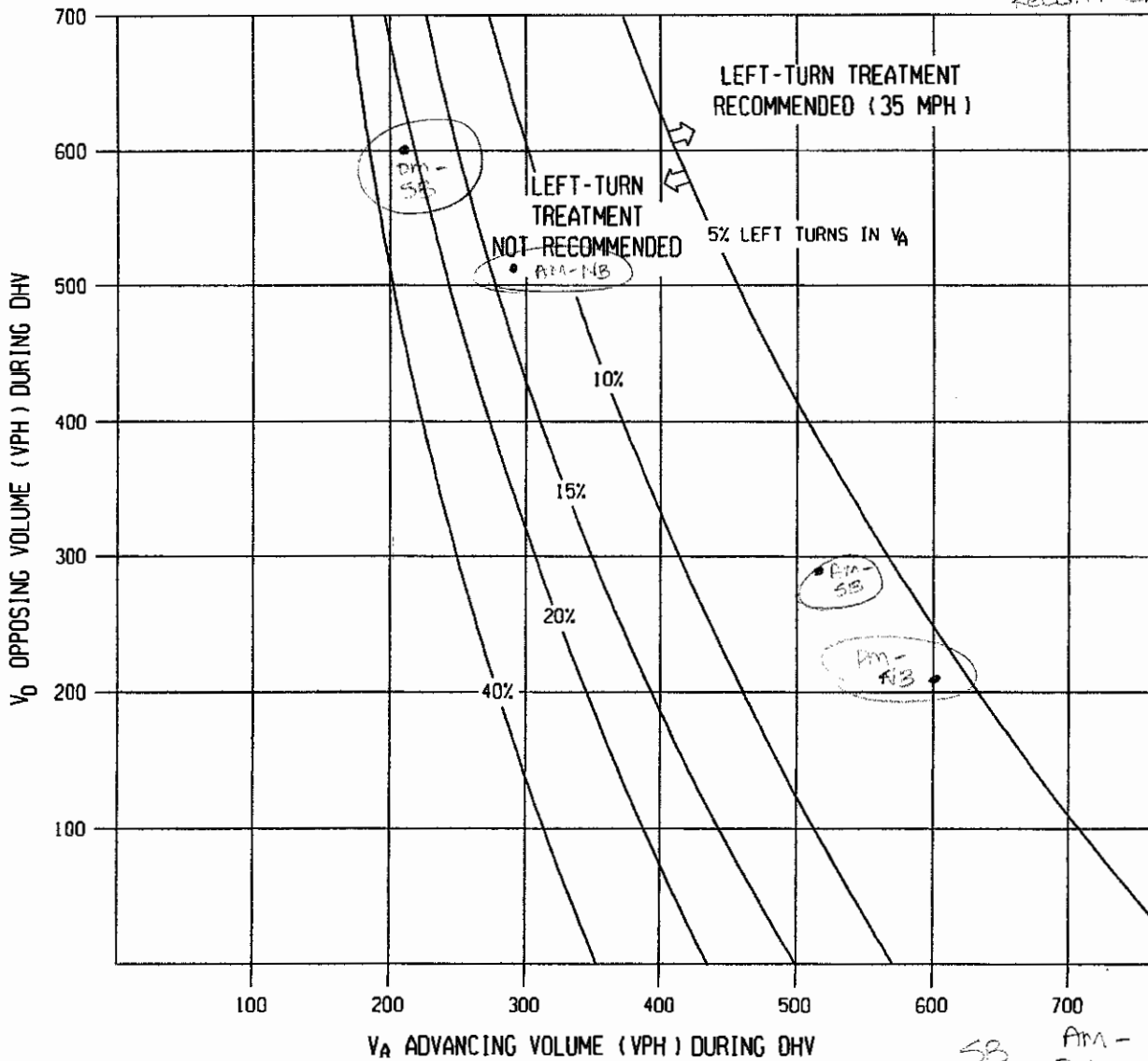

Instructions:

1. The family of curves represent the percentage of left turns in the advancing volume (V_A). The designer should locate the curve for the actual percentage of left turns. When this is not an even increment of 5, the designer should estimate where the curve lies.
2. Read V_A and V_0 into the chart and locate the intersection of the two volumes.
3. Note the location of the point in #2 relative to the line in #1. If the point is to the right of the line, then a left-turn lane is recommended. If the point is to the left of the line, then a left-turn is not recommended based on traffic volumes.

Example: Speed = 35mph

Advancing volume during DHV = 400 vph
 Opposing volume during DHV = 400 vph
 Percentage of left-turns in advancing volume = 7%

Problem: Determine if left-turn lane is recommended.

Solution: Figure indicates that the intersection of 400 vph and 400 vph is located to the left of the 7% curve (estimated); thus a left-turn lane is not recommended based on volumes.

SB AM - (518, 295) 29%
 PM - (209, 600) 20%
 * Left Turn Lane Recommended

MDOT
 Michigan Department of Transportation

TRAFFIC AND SAFETY NOTE

DRAWN BY: MTS
 CHECKED BY: JAT

08/05/2004
 PLAN DATE:

FILE: K:\DGN\ts notes\Note605A tsn.dgn

TRAFFIC VOLUME GUIDELINES FOR LEFT-TURN LANES AT UNSIGNALIZED INTERSECTIONS

605A

SHEET 3 OF 6

REV. 08/05/2004

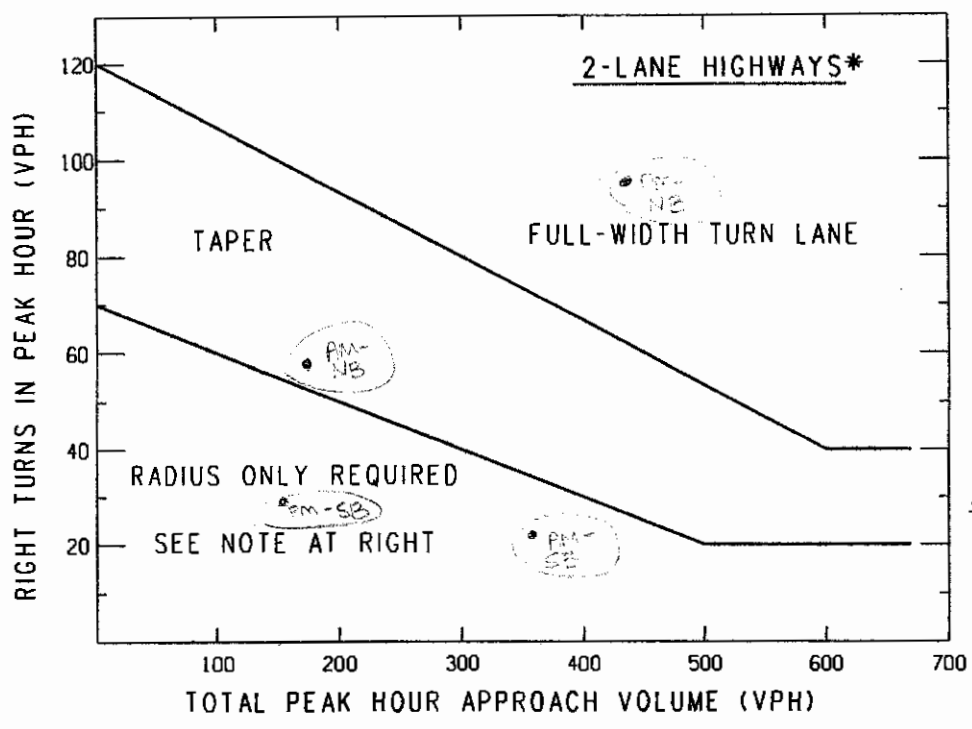

AM - (370, 30)
SB - PM - (148, 29)

NOTE:
For posted speeds at or under 45 mph, peak hour right turns greater than 40 vph, and total peak hour approach less than 300 vph, adjust right turn volumes.

Adjust peak hour right turns = Peak hour right turns - 20

*NB Right Turn Lane Recommended

*SB Right Turn Lane Recommended

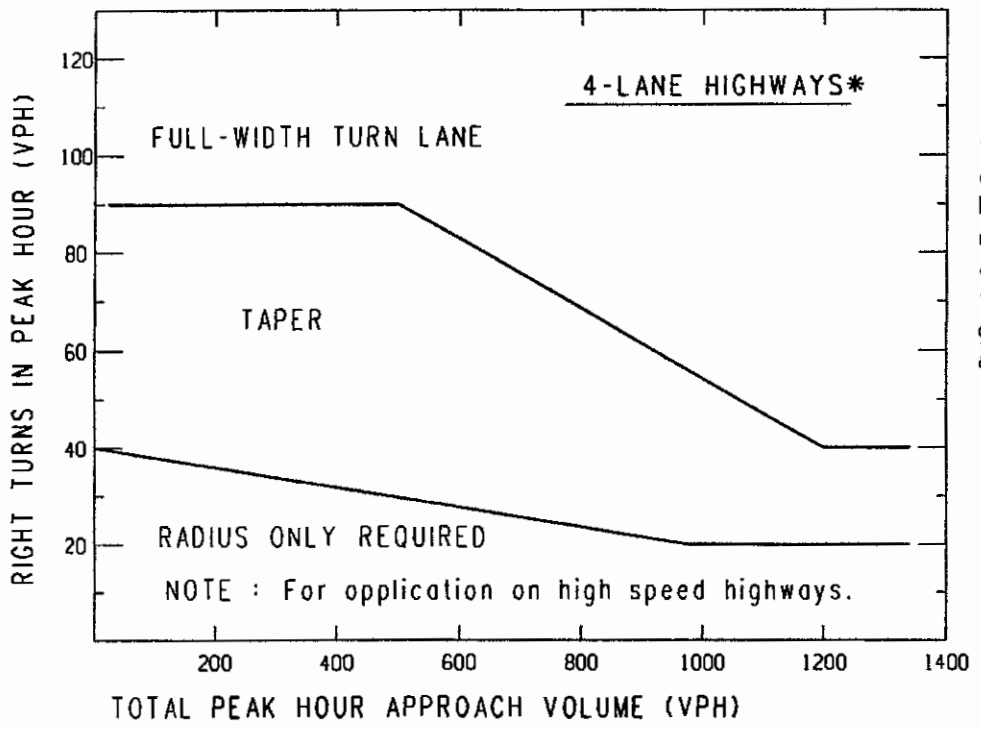

*If a center left-turn lane exists (i.e. 3 or 5 lane highway), subtract the number of left turns in approach volume from the total approach volume to get an adjusted total approach volume.

Sample Problem:

The Design Speed is 55 mph. The Peak Hour Approach Volume is 300 vph. The Number of Right Turns in the Peak Hour is 100 vph. Determine if a right turn lane is recommended.

Solution:

Figure indicates that the intersection of 300 vph and 100 vph is located above the upper trend line; thus, a right-turn lane may be recommended.

<p>TRAFFIC AND SAFETY NOTE</p>	<p>TRAFFIC VOLUME GUIDELINES FOR RIGHT-TURN LANES AND TAPERS</p>	
	<p>DRAWN BY: MTS</p> <p>CHECKED BY: JAT</p> <p>FILE: K:/DGN/ts notes/Note604A tsn.dgn</p>	<p>08/05/2004</p> <p>PLAN DATE:</p>

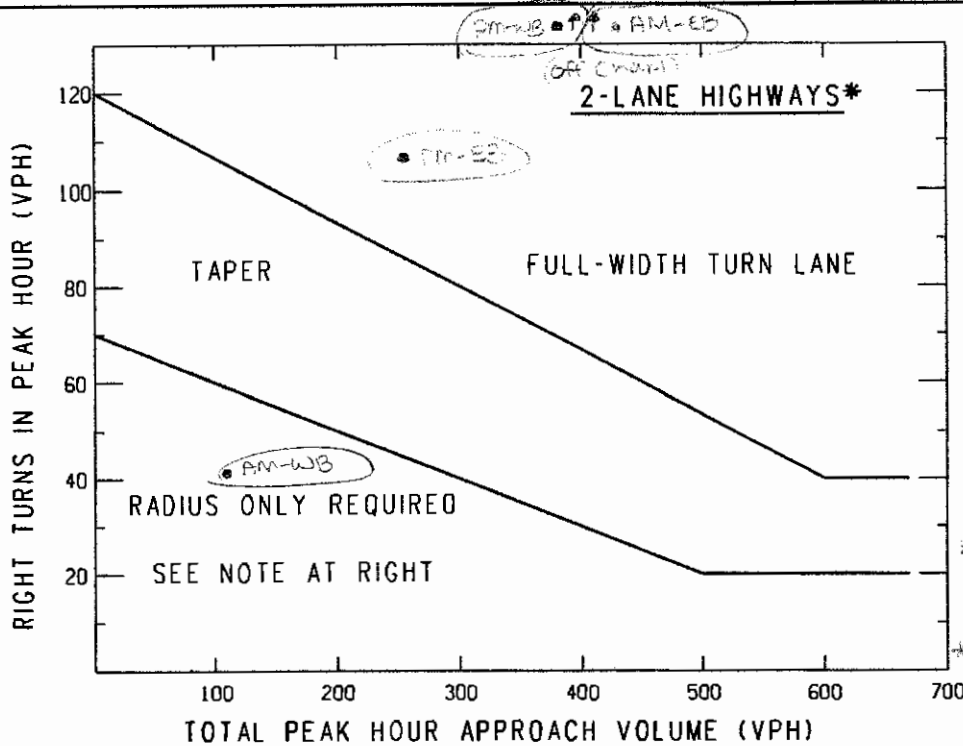

WB AM - (106, 4)
PM - (388, 208)

NOTE:

For posted speeds at or under 45 mph, peak hour right turns greater than 40 vph, and total peak hour approach less than 300 vph, adjust right turn volumes.

Adjust peak hour right turns = Peak hour right turns - 20

*EB - Full Right Turn Lane Recommended
*WB - Full Right Turn Lane Recommended

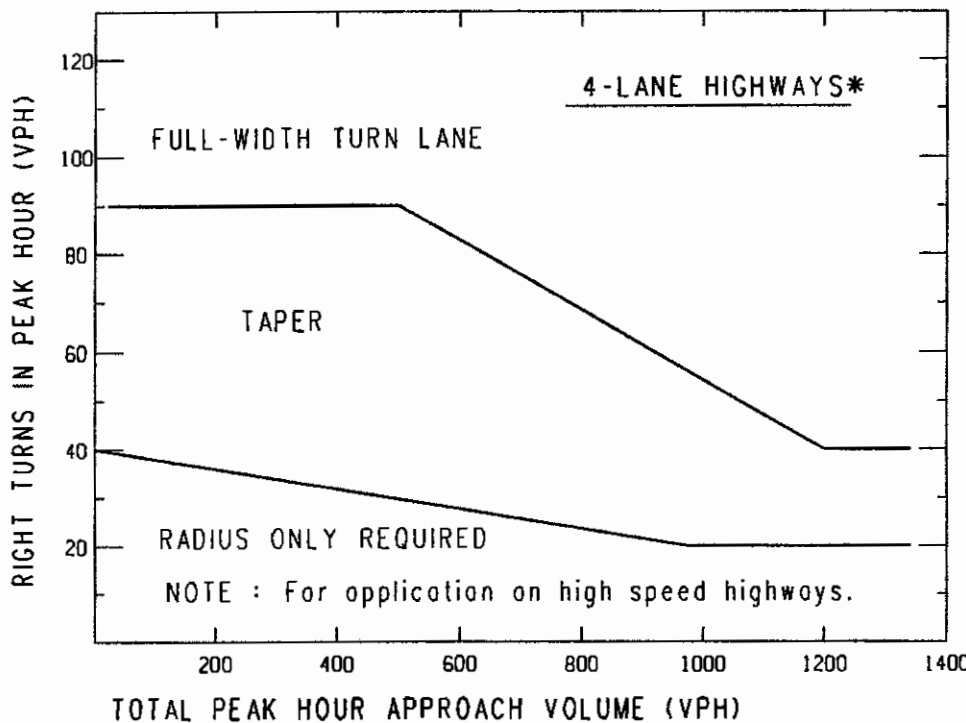

*If a center left-turn lane exists (i.e. 3 or 5 lane highway), subtract the number of left turns in approach volume from the total approach volume to get an adjusted total approach volume.

Sample Problem:

The Design Speed is 55 mph. The Peak Hour Approach Volume is 300 vph. The Number of Right Turns in the Peak Hour is 100 vph. Determine if a right turn lane is recommended.

Solution:

Figure indicates that the intersection of 300 vph and 100 vph is located above the upper trend line; thus, a right-turn lane may be recommended.



TRAFFIC AND SAFETY NOTE

TRAFFIC VOLUME GUIDELINES FOR RIGHT-TURN LANES AND TAPERS

DRAWN BY: MTS

08/05/2004

CHECKED BY: JAT

PLAN DATE

604A

SHEET

2 OF 2

FILE: K:/DGN/ts notes/Note604A tsn.dgn

REV. 08/05/2004

* Left Turn Lane Recommended

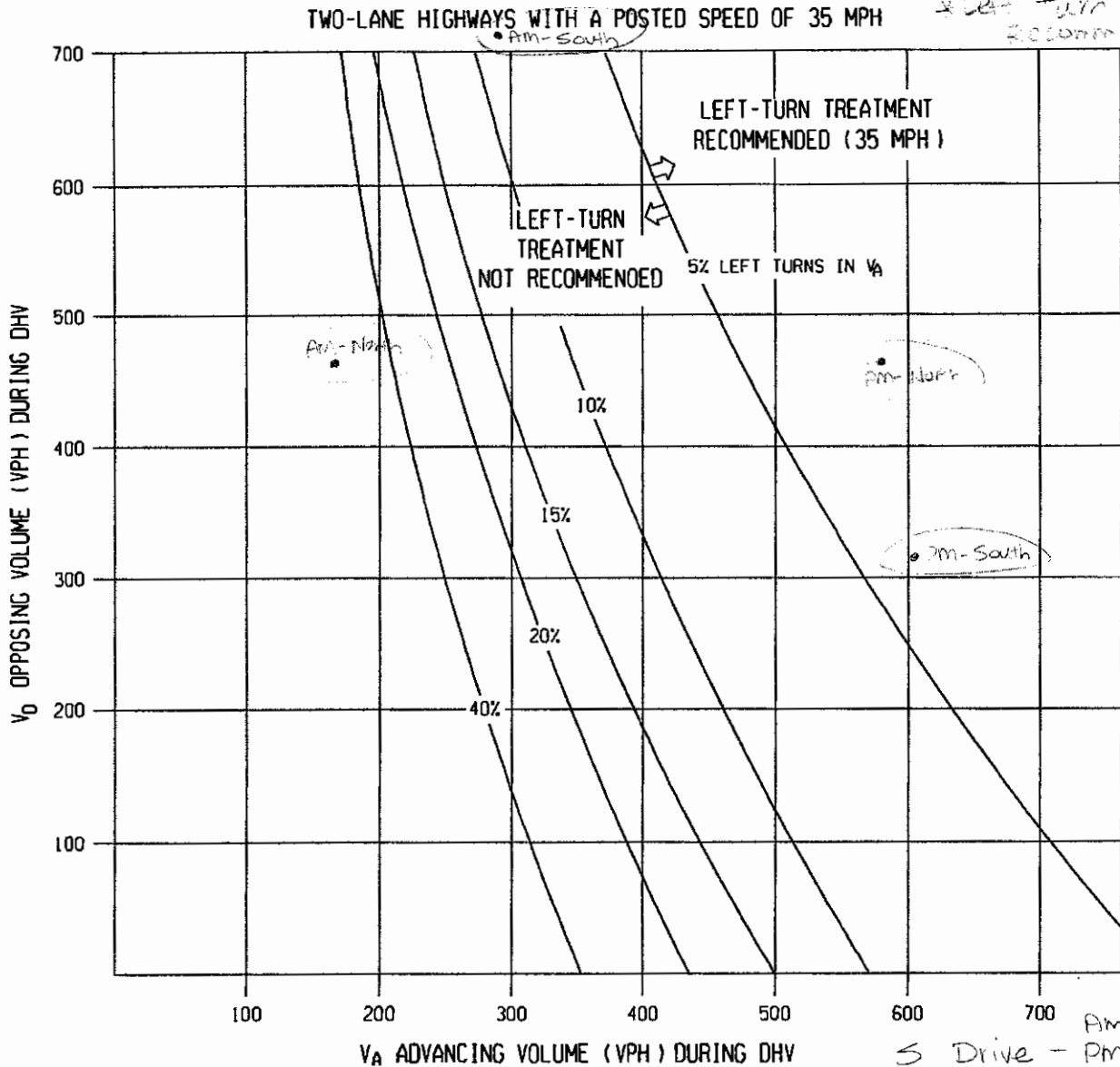

Instructions:

1. The family of curves represent the percentage of left turns in the advancing volume (V_A). The designer should locate the curve for the actual percentage of left turns. When this is not an even increment of 5, the designer should estimate where the curve lies.
2. Read V_A and V_0 into the chart and locate the intersection of the two volumes.
3. Note the location of the point in #2 relative to the line in #1. If the point is to the right of the line, then a left-turn lane is recommended. If the point is to the left of the line, then a left-turn is not recommended based on traffic volumes.

Example: Speed = 35mph
 Advancing volume during DHV = 400 vph
 Opposing volume during DHV = 400 vph
 Percentage of left-turns in advancing volume = 7%
Problem: Determine if left-turn lane is recommended.
Solution: Figure indicates that the intersection of 400 vph and 400 vph is located to the left of the 7% curve (estimated); thus a left-turn lane is not recommended based on volumes.

Am - 272,725
S Drive - Pm - (603,316) 4%

MDOT
Michigan Department of Transportation
TRAFFIC AND SAFETY NOTE

TRAFFIC VOLUME GUIDELINES FOR LEFT-TURN LANES AT UNSIGNALIZED INTERSECTIONS

DRAWN BY: MTS	08/05/2004	605A	SHEET
CHECKED BY: JAT	PLAN DATE		3 OF 6
FILE: K:/DGN/ts notes/Note605A tsn.dgn		REV. 08/05/2004	

* NO Left Turn Treatment Recommended

TWO-LANE HIGHWAYS WITH A POSTED SPEED OF 35 MPH

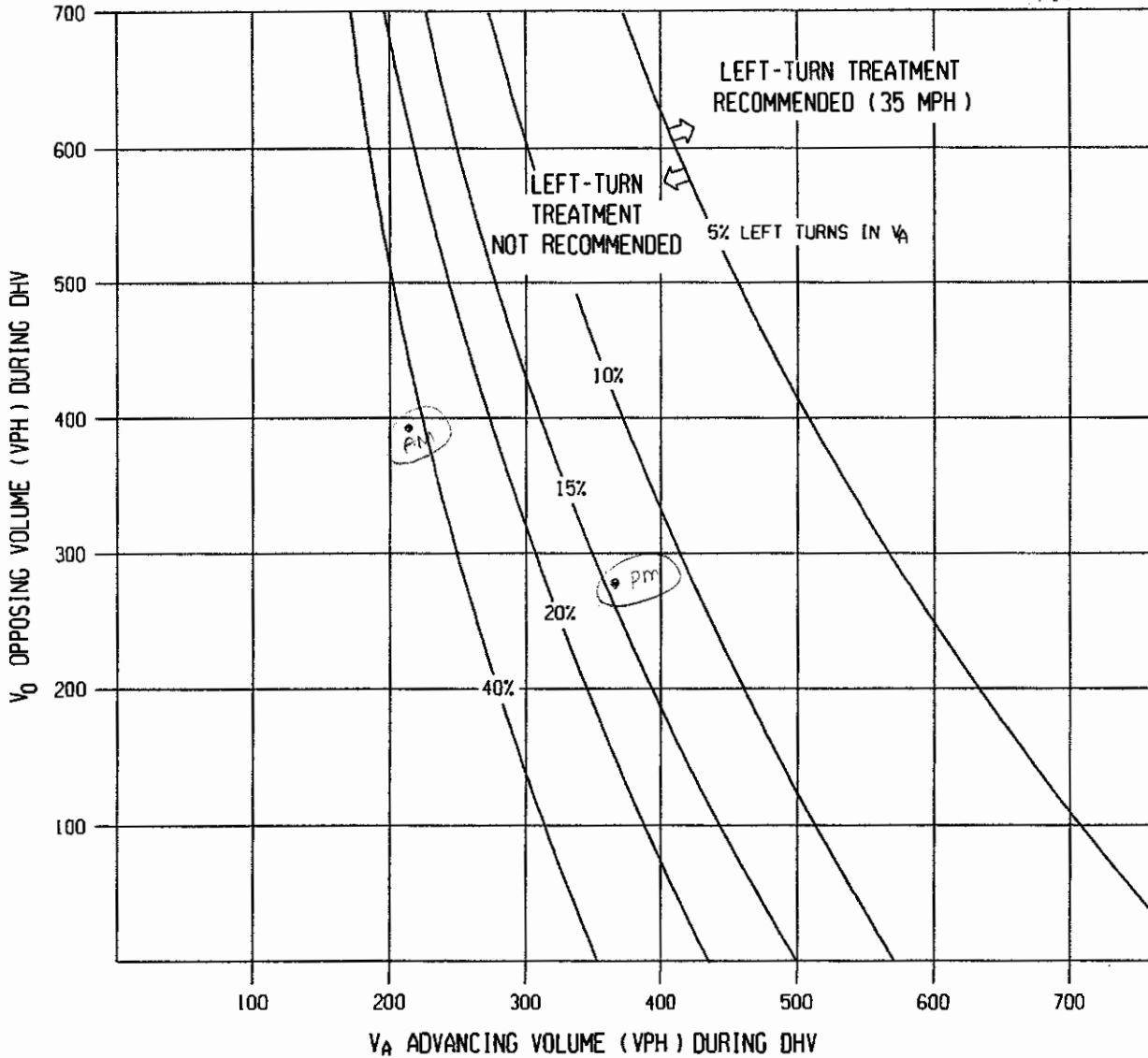

Instructions:

1. The family of curves represent the percentage of left turns in the advancing volume (V_A). The designer should locate the curve for the actual percentage of left turns. When this is not an even increment of 5, the designer should estimate where the curve lies.
2. Read V_A and V_0 into the chart and locate the intersection of the two volumes.
3. Note the location of the point in #2 relative to the line in #1. If the point is to the right of the line, then a left-turn lane is recommended. If the point is to the left of the line, then a left-turn is not recommended based on traffic volumes.

Example: Speed = 35mph

Advancing volume during DHV = 400 vph
 Opposing volume during DHV = 400 vph
 Percentage of left-turns in advancing volume = 7%

Problem: Determine if left-turn lane is recommended.

Solution: Figure indicates that the intersection of 400 vph and 400 vph is located to the left of the 7% curve (estimated); thus a left-turn lane is not recommended based on volumes.



TRAFFIC AND SAFETY NOTE

TRAFFIC VOLUME GUIDELINES FOR LEFT-TURN LANES AT UNSIGNALIZED INTERSECTIONS

DRAWN BY: MTS
 CHECKED BY: JAT

08/05/2004
 PLAN DATE:

605A

SHEET 3 OF 6

Michigan Manual of Uniform Traffic Control Devices Worksheet for Signal Warrants (Section 4C)

Spot Number: Future Volumes Analysis - Peak Hours

Major Street: Nixon Rd Minor Street: Dhu Varren/Green

Intersection: Nixon Rd at Dhu Varren/Green

City: City of Ann Arbor

Date Performed: 9/9/2014 Performed By: TEA, Inc.

Date Volumes Collected: _____

	Major NB	Major SB	Minor EB	Minor WB	Total Major	Highest Minor	Total
00:01 - 01:00	0	0	0	0	0	0	0
01:00 - 02:00	0	0	0	0	0	0	0
02:00 - 03:00	0	0	0	0	0	0	0
03:00 - 04:00	0	0	0	0	0	0	0
04:00 - 05:00	0	0	0	0	0	0	0
05:00 - 06:00	0	0	0	0	0	0	0
06:00 - 07:00	0	0	0	0	0	0	0
07:00 - 08:00	0	0	0	0	0	0	0
08:00 - 09:00	295	518	448	241	813	448	1502
09:00 - 10:00	0	0	0	0	0	0	0
10:00 - 11:00	0	0	0	0	0	0	0
11:00 - 12:00	0	0	0	0	0	0	0
12:00 - 13:00	0	0	0	0	0	0	0
13:00 - 14:00	0	0	0	0	0	0	0
14:00 - 15:00	0	0	0	0	0	0	0
15:00 - 16:00	0	0	0	0	0	0	0
16:00 - 17:00	600	209	298	455	809	455	1562
17:00 - 18:00	0	0	0	0	0	0	0
18:00 - 19:00	0	0	0	0	0	0	0
19:00 - 20:00	0	0	0	0	0	0	0
20:00 - 21:00	0	0	0	0	0	0	0
21:00 - 22:00	0	0	0	0	0	0	0
22:00 - 23:00	0	0	0	0	0	0	0
23:00 - 00:00	0	0	0	0	0	0	0
Total	895	727	746	696	1622	903	3064

Does the Posted Speed Limit exceed 40 mph on the major street? No

Does the intersection lie within a built-up area of an isolated community having a population of less than 10,000? No

Your intersection **CANNOT** use the 70% option to warrant the signal, do you want to use it? No

**Michigan Manual of Uniform Traffic Control Devices
Worksheet for Signal Warrants (Section 4C)**

Intersection: Nixon Rd at Dhu Varren/Green
City: City of Ann Arbor

Warrant 3B - Peak Hour

The peak hour volume warrant is also intended for application when traffic conditions are such that for one hour of the day minor street traffic suffers undue traffic delay in entering or crossing the main street.

The peak hour volume warrant is satisfied when the plotted point representing vehicles per hour on the higher volume minor street for one hour falls above the curve in Figure 4C-3.

Figure 4C-4 may be used if the 85th percentile speed of the major street exceeds 40 mph or when the intersection lies within a built-up area of an isolated community having a population less than 10,000.

**Peak Hour volume warrant - Major and Minor Streets
for Urban Locations - Warrant 3B**

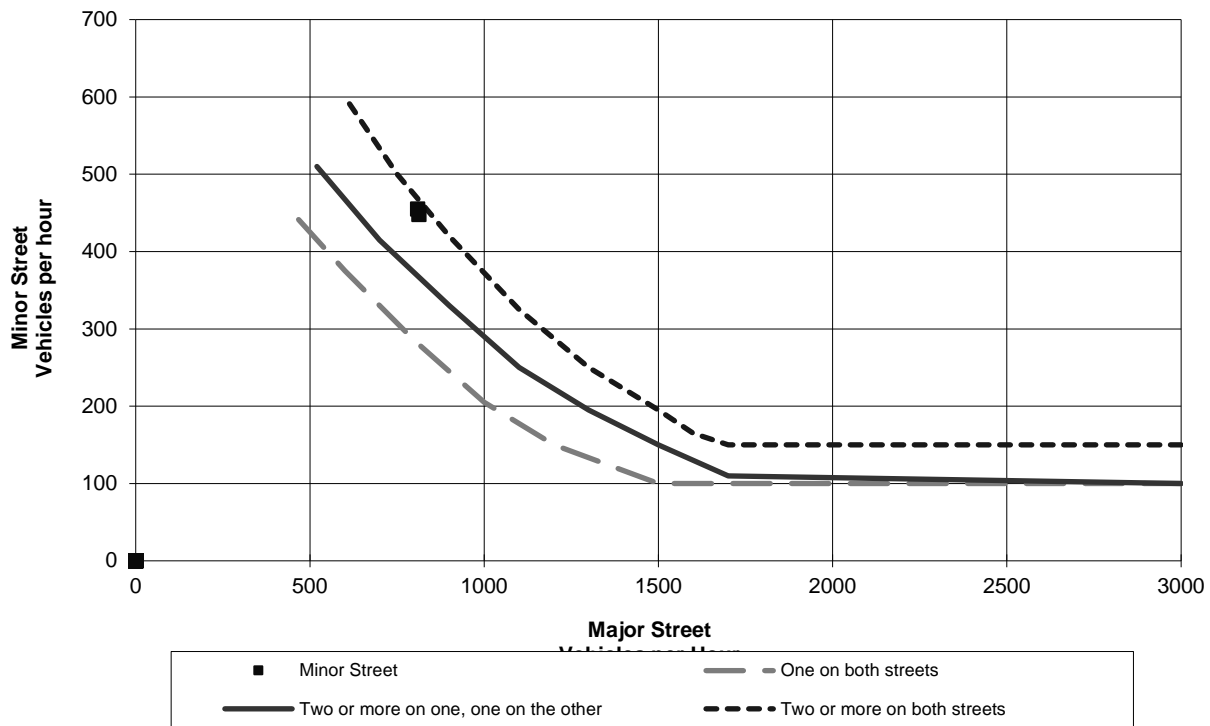









Warrant 3 Can be used because of Peak Hour Delay requirements.
(see Warrant 3A for more details).

Can the Peak Hour Volume Warrant be used? Yes
Is Peak Hour Volume Warrant Met? No









HCM Unsignalized Intersection Capacity Analysis
 9004: Nixon Rd & Dhu Varren Rd

6/26/2014

						
Movement	EBL	EBR	NBL	NBT	SBT	SBR
Lane Configurations						
Sign Control	Stop			Yield	Stop	
Volume (vph)	11	347	140	93	328	12
Peak Hour Factor	0.95	0.95	0.63	0.63	0.89	0.89
Hourly flow rate (vph)	12	365	222	148	369	13
Direction, Lane #	EB 1	NB 1	SB 1			
Volume Total (vph)	377	370	382			
Volume Left (vph)	12	222	0			
Volume Right (vph)	365	0	13			
Hadj (s)	-0.51	0.22	0.01			
Departure Headway (s)	5.5	5.9	5.7			
Degree Utilization, x	0.57	0.60	0.60			
Capacity (veh/h)	619	582	598			
Control Delay (s)	15.5	17.4	16.8			
Approach Delay (s)	15.5	17.4	16.8			
Approach LOS	C	C	C			
Intersection Summary						
Delay			16.6			
Level of Service			C			
Intersection Capacity Utilization			62.7%	ICU Level of Service	B	
Analysis Period (min)			15			

HCM Unsignalized Intersection Capacity Analysis
 9004: Nixon Rd & Dhu Varren Rd











7/7/2014

						
Movement	EBL	EBR	NBL	NBT	SBT	SBR
Lane Configurations						
Sign Control	Stop			Yield	Stop	
Volume (vph)	14	214	271	400	101	14
Peak Hour Factor	0.83	0.83	0.91	0.91	0.93	0.93
Hourly flow rate (vph)	17	258	298	440	109	15
Direction, Lane #	EB 1	NB 1	SB 1			
Volume Total (vph)	275	737	124			
Volume Left (vph)	17	298	0			
Volume Right (vph)	258	0	15			
Hadj (s)	-0.52	0.11	-0.04			
Departure Headway (s)	5.5	5.0	5.6			
Degree Utilization, x	0.42	1.0	0.19			
Capacity (veh/h)	640	721	616			
Control Delay (s)	12.4	63.9	10.0			
Approach Delay (s)	12.4	63.9	10.0			
Approach LOS	B	F	A			
Intersection Summary						
Delay			45.5			
Level of Service			E			
Intersection Capacity Utilization	63.4%		ICU Level of Service	B		
Analysis Period (min)			15			

HCM Unsignalized Intersection Capacity Analysis











9003: Nixon Rd & Green Road

6/26/2014

						
Movement	WBL	WBR	NBT	NBR	SBL	SBT
Lane Configurations						
Sign Control	Stop		Stop			Yield
Volume (vph)	120	83	150	58	245	430
Peak Hour Factor	0.74	0.74	0.63	0.63	0.89	0.89
Hourly flow rate (vph)	162	112	238	92	275	483
Direction, Lane #	WB 1	WB 2	NB 1	SB 1		
Volume Total (vph)	162	112	330	758		
Volume Left (vph)	162	0	0	275		
Volume Right (vph)	0	112	92	0		
Hadj (s)	0.57	-0.63	-0.07	0.11		
Departure Headway (s)	7.6	6.4	5.7	5.5		
Degree Utilization, x	0.34	0.20	0.52	1.0		
Capacity (veh/h)	463	547	620	654		
Control Delay (s)	13.2	9.8	14.8	105.5		
Approach Delay (s)	11.8		14.8	105.5		
Approach LOS	B		B	F		
Intersection Summary						
Delay			64.7			
Level of Service			F			
Intersection Capacity Utilization			64.3%	ICU Level of Service	C	
Analysis Period (min)			15			

























HCM Unsignalized Intersection Capacity Analysis
 9003: Nixon Rd & Green Road

7/7/2014

						
Movement	WBL	WBR	NBT	NBR	SBL	SBT
Lane Configurations						
Sign Control	Stop		Stop			Yield
Volume (vph)	47	305	366	81	150	165
Peak Hour Factor	0.91	0.91	0.91	0.91	0.93	0.93
Hourly flow rate (vph)	52	335	402	89	161	177
Direction, Lane #	WB 1	WB 2	NB 1	SB 1		
Volume Total (vph)	52	335	491	339		
Volume Left (vph)	52	0	0	161		
Volume Right (vph)	0	335	89	0		
Hadj (s)	0.52	-0.68	-0.07	0.13		
Departure Headway (s)	7.3	6.1	5.6	6.0		
Degree Utilization, x	0.10	0.57	0.77	0.57		
Capacity (veh/h)	465	551	625	560		
Control Delay (s)	10.0	15.5	24.5	16.7		
Approach Delay (s)	14.8		24.5	16.7		
Approach LOS	B		C	C		
Intersection Summary						
Delay			19.2			
Level of Service			C			
Intersection Capacity Utilization			54.5%	ICU Level of Service	A	
Analysis Period (min)			15			

Lanes, Volumes, Timings
1001: Nixon Rd & Plymouth Rd

7/7/2014

												
Lane Group	EBL	EBT	EBR	WBL	WBT	WBR	NBL	NBT	NBR	SBL	SBT	SBR
Lane Configurations		 			 			 			 	
Volume (vph)	77	697	75	13	777	103	13	11	8	173	59	164
Ideal Flow (vphpl)	1900	1900	1900	1900	1900	1900	1900	1900	1900	1900	1900	1900
Storage Length (ft)	135		0	105		0	75		0	95		0
Storage Lanes	1		0	1		0	1		0	1		0
Taper Length (ft)	25			25			25			25		
Lane Util. Factor	1.00	0.95	0.95	1.00	0.95	0.95	1.00	1.00	1.00	1.00	1.00	1.00
Frt		0.985			0.982			0.937				0.890
Flt Protected	0.950			0.950			0.950			0.950		
Satd. Flow (prot)	1736	3419	0	1752	3442	0	1597	1575	0	1752	1642	0
Flt Permitted	0.950			0.950			0.950			0.950		
Satd. Flow (perm)	1736	3419	0	1752	3442	0	1597	1575	0	1752	1642	0
Right Turn on Red			Yes			Yes			Yes			Yes
Satd. Flow (RTOR)		11			13			11				102
Link Speed (mph)		35			35			30				30
Link Distance (ft)		859			966			284				994
Travel Time (s)		16.7			18.8			6.5				22.6
Peak Hour Factor	0.94	0.94	0.94	0.92	0.92	0.92	0.73	0.73	0.73	0.79	0.79	0.79
Heavy Vehicles (%)	4%	4%	4%	3%	3%	3%	13%	13%	13%	3%	3%	3%
Adj. Flow (vph)	82	741	80	14	845	112	18	15	11	219	75	208
Shared Lane Traffic (%)												
Lane Group Flow (vph)	82	821	0	14	957	0	18	26	0	219	283	0
Turn Type	Prot	NA		Prot	NA		Prot	NA		Prot	NA	
Protected Phases	1	6		5	2		7	4		3	8	
Permitted Phases												
Detector Phase	1	6		5	2		7	4		3	8	
Switch Phase												
Minimum Initial (s)	4.0	10.0		8.0	10.0		4.0	7.0		4.0	10.0	
Minimum Split (s)	10.0	19.3		14.0	24.3		10.0	26.5		10.0	26.5	
Total Split (s)	25.0	48.0		23.0	46.0		21.0	28.0		21.0	28.0	
Total Split (%)	20.8%	40.0%		19.2%	38.3%		17.5%	23.3%		17.5%	23.3%	
Yellow Time (s)	3.5	3.6		3.5	3.6		3.5	3.5		3.5	3.5	
All-Red Time (s)	2.5	2.3		2.5	2.3		2.5	2.5		2.5	2.5	
Lost Time Adjust (s)	0.0	0.0		0.0	0.0		0.0	0.0		0.0	0.0	
Total Lost Time (s)	6.0	5.9		6.0	5.9		6.0	6.0		6.0	6.0	
Lead/Lag	Lead	Lag		Lead	Lag		Lead	Lag		Lead	Lag	
Lead-Lag Optimize?												
Recall Mode	None	C-Max		None	C-Max		None	None		None	None	
Act Effect Green (s)	11.0	74.7		8.0	65.9		7.0	11.8		15.2	22.0	
Actuated g/C Ratio	0.09	0.62		0.07	0.55		0.06	0.10		0.13	0.18	
v/c Ratio	0.52	0.38		0.12	0.50		0.20	0.16		0.99	0.74	
Control Delay	62.7	15.3		81.5	11.5		58.0	32.7		110.3	40.5	
Queue Delay	0.0	0.0		0.0	0.0		0.0	0.0		0.0	0.0	
Total Delay	62.7	15.3		81.5	11.5		58.0	32.7		110.3	40.5	
LOS	E	B		F	B		E	C		F	D	
Approach Delay		19.6			12.6			43.1			71.0	
Approach LOS		B			B			D			E	
Queue Length 50th (ft)	62	131		12	262		14	11		172	126	
Queue Length 95th (ft)	111	308		m22	343		31	28		#272	177	

Lanes, Volumes, Timings
 1001: Nixon Rd & Plymouth Rd

7/7/2014

Lane Group	EBL	EBT	EBR	WBL	WBT	WBR	NBL	NBT	NBR	SBL	SBT	SBR
Internal Link Dist (ft)		779			886			204			914	
Turn Bay Length (ft)	135			105			75			95		
Base Capacity (vph)	274	2133		248	1896		199	297		222	418	
Starvation Cap Reductn	0	0		0	0		0	0		0	0	
Spillback Cap Reductn	0	0		0	0		0	0		0	0	
Storage Cap Reductn	0	0		0	0		0	0		0	0	
Reduced v/c Ratio	0.30	0.38		0.06	0.50		0.09	0.09		0.99	0.68	

Intersection Summary

Area Type: Other
 Cycle Length: 120
 Actuated Cycle Length: 120
 Offset: 42 (35%), Referenced to phase 2:WBT and 6:EBT, Start of Green
 Natural Cycle: 90
 Control Type: Actuated-Coordinated
 Maximum v/c Ratio: 0.99
 Intersection Signal Delay: 27.8 Intersection LOS: C
 Intersection Capacity Utilization 60.2% ICU Level of Service B
 Analysis Period (min) 15
 # 95th percentile volume exceeds capacity, queue may be longer.
 Queue shown is maximum after two cycles.
 m Volume for 95th percentile queue is metered by upstream signal.



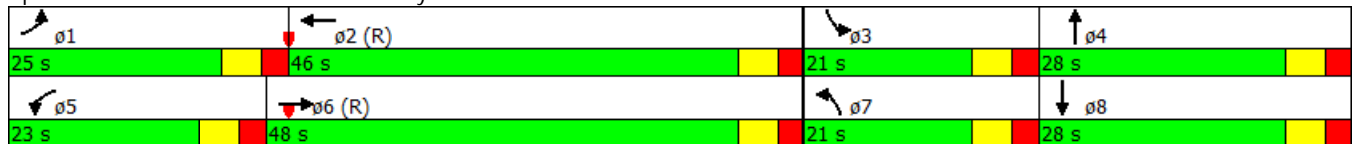





















Splits and Phases: 1001: Nixon Rd & Plymouth Rd



Intersection				
Intersection Delay, s/veh	18.2			
Intersection LOS	C			
Approach	EB	WB	NB	SB
Entry Lanes	1	1	1	1
Conflicting Circle Lanes	1	1	1	1
Adj Approach Flow, veh/h	334	483	497	464
Demand Flow Rate, veh/h	351	498	527	478
Vehicles Circulating, veh/h	508	519	461	219
Vehicles Exiting, veh/h	189	469	397	798
Follow-Up Headway, s	3.186	3.186	3.186	3.186
Ped Vol Crossing Leg, #/h	0	0	0	0
Ped Cap Adj	1.000	1.000	1.000	1.000
Approach Delay, s/veh	13.9	23.3	22.7	11.2
Approach LOS	B	C	C	B
Lane	Left	Left	Left	Left
Designated Moves	LTR	LTR	LTR	LTR
Assumed Moves	LTR	LTR	LTR	LTR
RT Channelized				
Lane Util	1.000	1.000	1.000	1.000
Critical Headway, s	5.193	5.193	5.193	5.193
Entry Flow, veh/h	351	498	527	478
Cap Entry Lane, veh/h	680	672	713	908
Entry HV Adj Factor	0.953	0.969	0.944	0.971
Flow Entry, veh/h	334	483	497	464
Cap Entry, veh/h	648	652	672	881
V/C Ratio	0.516	0.741	0.740	0.527
Control Delay, s/veh	13.9	23.3	22.7	11.2
LOS	B	C	C	B
95th %tile Queue, veh	3	7	7	3

Lanes, Volumes, Timings
1001: Nixon Rd & Plymouth Rd

6/26/2014

												
Lane Group	EBL	EBT	EBR	WBL	WBT	WBR	NBL	NBT	NBR	SBL	SBT	SBR
Lane Configurations		 			 			 			 	
Volume (vph)	77	697	75	13	777	103	13	11	8	173	59	164
Ideal Flow (vphpl)	1900	1900	1900	1900	1900	1900	1900	1900	1900	1900	1900	1900
Storage Length (ft)	135		0	105		0	75		0	95		0
Storage Lanes	1		0	1		0	1		0	1		0
Taper Length (ft)	25			25			25			25		
Lane Util. Factor	1.00	0.95	0.95	1.00	0.95	0.95	1.00	1.00	1.00	1.00	1.00	1.00
Frt		0.985			0.982			0.937			0.890	
Flt Protected	0.950			0.950			0.950			0.950		
Satd. Flow (prot)	1736	3419	0	1752	3442	0	1597	1575	0	1752	1642	0
Flt Permitted	0.950			0.950			0.950			0.950		
Satd. Flow (perm)	1736	3419	0	1752	3442	0	1597	1575	0	1752	1642	0
Right Turn on Red			Yes			Yes			Yes			Yes
Satd. Flow (RTOR)		11			13			11			102	
Link Speed (mph)		35			35			30			30	
Link Distance (ft)		859			966			284			994	
Travel Time (s)		16.7			18.8			6.5			22.6	
Peak Hour Factor	0.94	0.94	0.94	0.92	0.92	0.92	0.73	0.73	0.73	0.79	0.79	0.79
Heavy Vehicles (%)	4%	4%	4%	3%	3%	3%	13%	13%	13%	3%	3%	3%
Adj. Flow (vph)	82	741	80	14	845	112	18	15	11	219	75	208
Shared Lane Traffic (%)												
Lane Group Flow (vph)	82	821	0	14	957	0	18	26	0	219	283	0
Turn Type	Prot	NA		Prot	NA		Prot	NA		Prot	NA	
Protected Phases	1	6		5	2		7	4		3	8	
Permitted Phases												
Detector Phase	1	6		5	2		7	4		3	8	
Switch Phase												
Minimum Initial (s)	4.0	10.0		8.0	10.0		4.0	7.0		4.0	10.0	
Minimum Split (s)	10.0	19.3		14.0	24.3		10.0	26.5		10.0	26.5	
Total Split (s)	25.0	48.0		23.0	46.0		21.0	28.0		21.0	28.0	
Total Split (%)	20.8%	40.0%		19.2%	38.3%		17.5%	23.3%		17.5%	23.3%	
Yellow Time (s)	3.5	3.6		3.5	3.6		3.5	3.5		3.5	3.5	
All-Red Time (s)	2.5	2.3		2.5	2.3		2.5	2.5		2.5	2.5	
Lost Time Adjust (s)	0.0	0.0		0.0	0.0		0.0	0.0		0.0	0.0	
Total Lost Time (s)	6.0	5.9		6.0	5.9		6.0	6.0		6.0	6.0	
Lead/Lag	Lead	Lag		Lead	Lag		Lead	Lag		Lead	Lag	
Lead-Lag Optimize?												
Recall Mode	None	C-Max		None	C-Max		None	None		None	None	
Act Effect Green (s)	11.0	74.7		8.0	65.9		7.0	11.8		15.2	22.0	
Actuated g/C Ratio	0.09	0.62		0.07	0.55		0.06	0.10		0.13	0.18	
v/c Ratio	0.52	0.38		0.12	0.50		0.20	0.16		0.99	0.74	
Control Delay	62.7	15.3		81.5	11.5		58.0	32.7		110.3	40.5	
Queue Delay	0.0	0.0		0.0	0.0		0.0	0.0		0.0	0.0	
Total Delay	62.7	15.3		81.5	11.5		58.0	32.7		110.3	40.5	
LOS	E	B		F	B		E	C		F	D	
Approach Delay		19.6			12.6			43.1			71.0	
Approach LOS		B			B			D			E	
Queue Length 50th (ft)	62	131		12	262		14	11		172	126	
Queue Length 95th (ft)	111	308		m22	343		31	28		#272	177	

Lanes, Volumes, Timings
 1001: Nixon Rd & Plymouth Rd

6/26/2014

Lane Group	EBL	EBT	EBR	WBL	WBT	WBR	NBL	NBT	NBR	SBL	SBT	SBR
Internal Link Dist (ft)		779			886			204			914	
Turn Bay Length (ft)	135			105			75			95		
Base Capacity (vph)	274	2133		248	1896		199	297		222	418	
Starvation Cap Reductn	0	0		0	0		0	0		0	0	
Spillback Cap Reductn	0	0		0	0		0	0		0	0	
Storage Cap Reductn	0	0		0	0		0	0		0	0	
Reduced v/c Ratio	0.30	0.38		0.06	0.50		0.09	0.09		0.99	0.68	

Intersection Summary





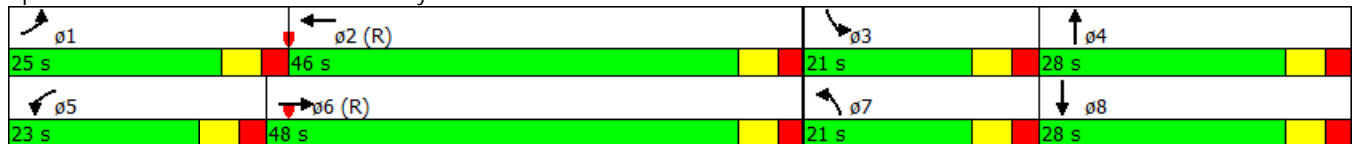



















Area Type: Other
 Cycle Length: 120
 Actuated Cycle Length: 120
 Offset: 42 (35%), Referenced to phase 2:WBT and 6:EBT, Start of Green
 Natural Cycle: 90
 Control Type: Actuated-Coordinated
 Maximum v/c Ratio: 0.99
 Intersection Signal Delay: 27.8 Intersection LOS: C
 Intersection Capacity Utilization 60.2% ICU Level of Service B
 Analysis Period (min) 15
 # 95th percentile volume exceeds capacity, queue may be longer.
 Queue shown is maximum after two cycles.
 m Volume for 95th percentile queue is metered by upstream signal.

Splits and Phases: 1001: Nixon Rd & Plymouth Rd

























Lanes, Volumes, Timings
1001: Nixon Rd & Plymouth Rd

7/7/2014

												
Lane Group	EBL	EBT	EBR	WBL	WBT	WBR	NBL	NBT	NBR	SBL	SBT	SBR
Lane Configurations		 			 			 			 	
Volume (vph)	188	716	33	12	817	99	87	49	38	242	14	157
Ideal Flow (vphpl)	1900	1900	1900	1900	1900	1900	1900	1900	1900	1900	1900	1900
Storage Length (ft)	135		0	105		0	75		0	95		0
Storage Lanes	1		0	1		0	1		0	1		0
Taper Length (ft)	25			25			25			25		
Lane Util. Factor	1.00	0.95	0.95	1.00	0.95	0.95	1.00	1.00	1.00	1.00	1.00	1.00
Frt		0.993			0.984			0.934			0.862	
Flt Protected	0.950			0.950			0.950			0.950		
Satd. Flow (prot)	1770	3514	0	1787	3517	0	1787	1757	0	1770	1606	0
Flt Permitted	0.950			0.950			0.950			0.950		
Satd. Flow (perm)	1770	3514	0	1787	3517	0	1787	1757	0	1770	1606	0
Right Turn on Red			Yes			Yes			Yes			Yes
Satd. Flow (RTOR)		4			12			29				173
Link Speed (mph)		35			35			30				30
Link Distance (ft)		859			966			284				994
Travel Time (s)		16.7			18.8			6.5				22.6
Peak Hour Factor	0.90	0.90	0.90	0.92	0.92	0.92	0.78	0.78	0.78	0.91	0.91	0.91
Heavy Vehicles (%)	2%	2%	2%	1%	1%	1%	1%	1%	1%	2%	2%	2%
Adj. Flow (vph)	209	796	37	13	888	108	112	63	49	266	15	173
Shared Lane Traffic (%)												
Lane Group Flow (vph)	209	833	0	13	996	0	112	112	0	266	188	0
Turn Type	Prot	NA		Prot	NA		Prot	NA		Prot	NA	
Protected Phases	1	6		5	2		7	4		3	8	
Permitted Phases												
Detector Phase	1	6		5	2		7	4		3	8	
Switch Phase												
Minimum Initial (s)	4.0	10.0		8.0	10.0		4.0	7.0		4.0	10.0	
Minimum Split (s)	10.0	19.3		14.0	24.3		10.0	26.5		10.0	26.5	
Total Split (s)	21.0	49.0		22.0	50.0		21.0	28.0		21.0	28.0	
Total Split (%)	17.5%	40.8%		18.3%	41.7%		17.5%	23.3%		17.5%	23.3%	
Yellow Time (s)	3.5	3.6		3.5	3.6		3.5	3.5		3.5	3.5	
All-Red Time (s)	2.5	2.3		2.5	2.3		2.5	2.5		2.5	2.5	
Lost Time Adjust (s)	0.0	0.0		0.0	0.0		0.0	0.0		0.0	0.0	
Total Lost Time (s)	6.0	5.9		6.0	5.9		6.0	6.0		6.0	6.0	
Lead/Lag	Lead	Lag		Lead	Lag		Lead	Lag		Lead	Lag	
Lead-Lag Optimize?												
Recall Mode	None	C-Max		None	C-Max		None	None		None	None	
Act Effect Green (s)	20.5	70.2		8.0	49.3		12.3	11.3		15.0	14.0	
Actuated g/C Ratio	0.17	0.58		0.07	0.41		0.10	0.09		0.12	0.12	
v/c Ratio	0.69	0.40		0.11	0.69		0.62	0.59		1.20	0.55	
Control Delay	59.3	15.8		63.8	24.6		65.8	50.2		171.3	15.7	
Queue Delay	0.0	0.0		0.0	0.0		0.0	0.0		0.0	0.0	
Total Delay	59.3	15.8		63.8	24.6		65.8	50.2		171.3	15.7	
LOS	E	B		E	C		E	D		F	B	
Approach Delay		24.5			25.1			58.0			106.8	
Approach LOS		C			C			E			F	
Queue Length 50th (ft)	152	151		11	363		84	62		-250	11	
Queue Length 95th (ft)	238	283		m19	214		122	97		#421	80	

Lanes, Volumes, Timings
 1002: Huron Pkwy & Plymouth Rd

6/26/2014

												
Lane Group	EBL	EBT	EBR	WBL	WBT	WBR	NBL	NBT	NBR	SBL	SBT	SBR
Lane Configurations												
Volume (vph)	2	700	176	35	804	127	82	176	148	180	215	7
Ideal Flow (vphpl)	1900	1900	1900	1900	1900	1900	1900	1900	1900	1900	1900	1900
Storage Length (ft)	120		0	195		0	410		450	120		0
Storage Lanes	1		0	1		0	1		1	1		0
Taper Length (ft)	25			25			25			25		
Lane Util. Factor	1.00	0.95	0.95	1.00	0.95	0.95	1.00	0.95	1.00	1.00	0.95	0.95
Frt		0.970			0.980				0.850		0.995	
Flt Protected	0.950			0.950			0.950			0.950		
Satd. Flow (prot)	1770	3433	0	1770	3468	0	1770	3539	1583	1770	3522	0
Flt Permitted	0.950			0.950			0.950			0.950		
Satd. Flow (perm)	1770	3433	0	1770	3468	0	1770	3539	1583	1770	3522	0
Right Turn on Red			Yes			Yes			Yes			Yes
Satd. Flow (RTOR)		24			17				88			2
Link Speed (mph)		35			35			35			35	
Link Distance (ft)		966			889			979			397	
Travel Time (s)		18.8			17.3			19.1			7.7	
Peak Hour Factor	0.93	0.93	0.93	0.86	0.86	0.86	0.98	0.98	0.98	0.84	0.84	0.84
Adj. Flow (vph)	2	753	189	41	935	148	84	180	151	214	256	8
Shared Lane Traffic (%)												
Lane Group Flow (vph)	2	942	0	41	1083	0	84	180	151	214	264	0
Turn Type	Prot	NA		Prot	NA		Prot	NA	pm+ov	Prot	NA	
Protected Phases	1	6		5	2		7	4	5	3	8	
Permitted Phases									4			
Detector Phase	1	6		5	2		7	4	5	3	8	
Switch Phase												
Minimum Initial (s)	4.0	20.0		4.0	10.0		4.0	10.0	4.0	4.0	10.0	
Minimum Split (s)	16.0	34.0		34.0	52.0		23.0	30.0	34.0	22.0	29.0	
Total Split (s)	16.0	34.0		34.0	52.0		23.0	30.0	34.0	22.0	29.0	
Total Split (%)	13.3%	28.3%		28.3%	43.3%		19.2%	25.0%	28.3%	18.3%	24.2%	
Yellow Time (s)	3.6	3.6		4.3	4.3		3.9	3.9	4.3	3.6	3.6	
All-Red Time (s)	2.3	2.5		2.5	2.3		2.5	2.0	2.5	2.5	2.3	
Lost Time Adjust (s)	0.0	0.0		0.0	0.0		0.0	0.0	0.0	0.0	0.0	
Total Lost Time (s)	5.9	6.1		6.8	6.6		6.4	5.9	6.8	6.1	5.9	
Lead/Lag	Lead	Lag		Lead	Lag		Lead	Lag	Lead	Lead	Lag	
Lead-Lag Optimize?												
Recall Mode	None	C-Max		None	C-Max		None	None	None	None	None	
Act Effect Green (s)	5.7	58.6		8.3	70.7		11.0	12.4	26.6	15.9	19.6	
Actuated g/C Ratio	0.05	0.49		0.07	0.59		0.09	0.10	0.22	0.13	0.16	
v/c Ratio	0.02	0.56		0.34	0.53		0.52	0.49	0.36	0.92	0.46	
Control Delay	44.0	21.6		60.0	16.8		62.6	55.0	18.6	92.7	49.2	
Queue Delay	0.0	0.0		0.0	0.0		0.0	0.0	0.0	0.0	0.0	
Total Delay	44.0	21.6		60.0	16.8		62.6	55.0	18.6	92.7	49.2	
LOS	D	C		E	B		E	D	B	F	D	
Approach Delay		21.7			18.4			43.3			68.7	
Approach LOS		C			B			D			E	
Queue Length 50th (ft)	2	180		31	225		63	71	40	166	101	
Queue Length 95th (ft)	m3	m281		64	377		113	103	92	#280	133	
Internal Link Dist (ft)		886			809			899			317	

Lanes, Volumes, Timings
 1002: Huron Pkwy & Plymouth Rd

6/26/2014

Lane Group	EBL	EBT	EBR	WBL	WBT	WBR	NBL	NBT	NBR	SBL	SBT	SBR
Turn Bay Length (ft)	120			195			410		450	120		
Base Capacity (vph)	148	1688		401	2050		244	710	654	234	730	
Starvation Cap Reductn	0	0		0	0		0	0	0	0	0	
Spillback Cap Reductn	0	0		0	0		0	0	0	0	0	
Storage Cap Reductn	0	0		0	0		0	0	0	0	0	
Reduced v/c Ratio	0.01	0.56		0.10	0.53		0.34	0.25	0.23	0.91	0.36	

Intersection Summary





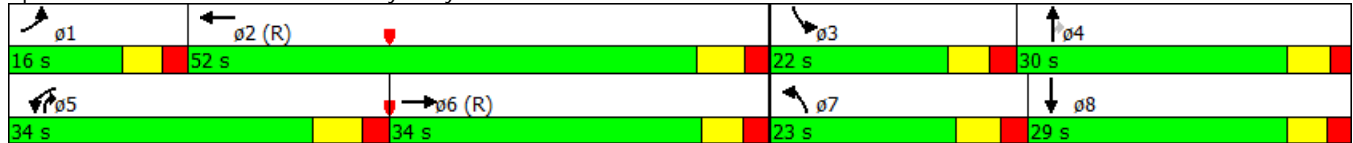

















Area Type: Other
 Cycle Length: 120
 Actuated Cycle Length: 120
 Offset: 40 (33%), Referenced to phase 2:WBT and 6:EBT, Start of Green
 Natural Cycle: 120
 Control Type: Actuated-Coordinated
 Maximum v/c Ratio: 0.92
 Intersection Signal Delay: 31.0 Intersection LOS: C
 Intersection Capacity Utilization 62.7% ICU Level of Service B
 Analysis Period (min) 15
 # 95th percentile volume exceeds capacity, queue may be longer.
 Queue shown is maximum after two cycles.
 m Volume for 95th percentile queue is metered by upstream signal.

Splits and Phases: 1002: Huron Pkwy & Plymouth Rd



Lanes, Volumes, Timings
1002: Huron Pkwy & Plymouth Rd

7/7/2014

												
Lane Group	EBL	EBT	EBR	WBL	WBT	WBR	NBL	NBT	NBR	SBL	SBT	SBR
Lane Configurations												
Volume (vph)	19	823	154	106	679	115	225	267	292	206	152	24
Ideal Flow (vphpl)	1900	1900	1900	1900	1900	1900	1900	1900	1900	1900	1900	1900
Storage Length (ft)	120		0	195		0	410		450	120		0
Storage Lanes	1		0	1		0	1		1	1		0
Taper Length (ft)	25			25			25			25		
Lane Util. Factor	1.00	0.95	0.95	1.00	0.95	0.95	1.00	0.95	1.00	1.00	0.95	0.95
Frt		0.976			0.978				0.850		0.979	
Flt Protected	0.950			0.950			0.950			0.950		
Satd. Flow (prot)	1770	3454	0	1770	3461	0	1770	3539	1583	1770	3465	0
Flt Permitted	0.950			0.950			0.950			0.950		
Satd. Flow (perm)	1770	3454	0	1770	3461	0	1770	3539	1583	1770	3465	0
Right Turn on Red			Yes			Yes			Yes			Yes
Satd. Flow (RTOR)		18			17				88		13	
Link Speed (mph)		35			35			35		35		35
Link Distance (ft)		966			889			979		397		
Travel Time (s)		18.8			17.3			19.1		7.7		
Peak Hour Factor	0.93	0.93	0.93	0.86	0.86	0.86	0.98	0.98	0.98	0.84	0.84	0.84
Adj. Flow (vph)	20	885	166	123	790	134	230	272	298	245	181	29
Shared Lane Traffic (%)												
Lane Group Flow (vph)	20	1051	0	123	924	0	230	272	298	245	210	0
Turn Type	Prot	NA		Prot	NA		Prot	NA	pm+ov	Prot	NA	
Protected Phases	1	6		5	2		7	4	5	3	8	
Permitted Phases									4			
Detector Phase	1	6		5	2		7	4	5	3	8	
Switch Phase												
Minimum Initial (s)	4.0	20.0		4.0	10.0		4.0	10.0	4.0	4.0	10.0	
Minimum Split (s)	9.9	27.5		10.8	27.3		10.4	26.0	10.8	10.1	25.3	
Total Split (s)	16.0	40.0		23.0	47.0		28.0	30.0	23.0	27.0	29.0	
Total Split (%)	13.3%	33.3%		19.2%	39.2%		23.3%	25.0%	19.2%	22.5%	24.2%	
Yellow Time (s)	3.6	3.6		4.3	4.3		3.9	3.9	4.3	3.6	3.6	
All-Red Time (s)	2.3	2.5		2.5	2.3		2.5	2.0	2.5	2.5	2.3	
Lost Time Adjust (s)	0.0	0.0		0.0	0.0		0.0	0.0	0.0	0.0	0.0	
Total Lost Time (s)	5.9	6.1		6.8	6.6		6.4	5.9	6.8	6.1	5.9	
Lead/Lag	Lead	Lag		Lead	Lag		Lead	Lag	Lead	Lead	Lag	
Lead-Lag Optimize?												
Recall Mode	None	C-Max		None	C-Max		None	None	None	None	None	
Act Effect Green (s)	6.9	47.5		13.6	61.8		19.3	14.5	34.0	19.5	14.4	
Actuated g/C Ratio	0.06	0.40		0.11	0.52		0.16	0.12	0.28	0.16	0.12	
v/c Ratio	0.20	0.76		0.61	0.52		0.81	0.64	0.58	0.85	0.49	
Control Delay	58.1	29.4		63.4	22.3		70.3	56.9	29.3	75.2	50.0	
Queue Delay	0.0	0.0		0.0	0.0		0.0	0.0	0.0	0.0	0.0	
Total Delay	58.1	29.4		63.4	22.3		70.3	56.9	29.3	75.2	50.0	
LOS	E	C		E	C		E	E	C	E	D	
Approach Delay		30.0			27.1			50.5			63.6	
Approach LOS		C			C			D			E	
Queue Length 50th (ft)	16	379		92	216		171	107	139	184	76	
Queue Length 95th (ft)	m33	m#246		143	350		#275	148	208	#274	104	
Internal Link Dist (ft)		886			809			899			317	

Lanes, Volumes, Timings
 1002: Huron Pkwy & Plymouth Rd

7/7/2014

Lane Group	EBL	EBT	EBR	WBL	WBT	WBR	NBL	NBT	NBR	SBL	SBT	SBR
Turn Bay Length (ft)	120			195			410		450	120		
Base Capacity (vph)	148	1379		245	1790		318	710	550	308	677	
Starvation Cap Reductn	0	0		0	0		0	0	0	0	0	
Spillback Cap Reductn	0	0		0	0		0	0	0	0	0	
Storage Cap Reductn	0	0		0	0		0	0	0	0	0	
Reduced v/c Ratio	0.14	0.76		0.50	0.52		0.72	0.38	0.54	0.80	0.31	

Intersection Summary

Area Type: Other
 Cycle Length: 120
 Actuated Cycle Length: 120
 Offset: 40 (33%), Referenced to phase 2:WBT and 6:EBT, Start of Green
 Natural Cycle: 90
 Control Type: Actuated-Coordinated
 Maximum v/c Ratio: 0.85
 Intersection Signal Delay: 38.5 Intersection LOS: D
 Intersection Capacity Utilization 75.3% ICU Level of Service D
 Analysis Period (min) 15
 # 95th percentile volume exceeds capacity, queue may be longer.
 Queue shown is maximum after two cycles.
 m Volume for 95th percentile queue is metered by upstream signal.

Splits and Phases: 1002: Huron Pkwy & Plymouth Rd

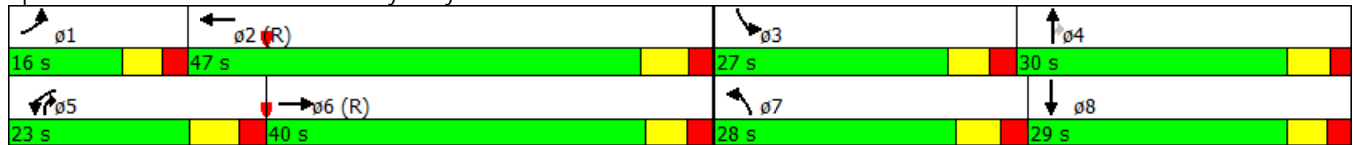

HCM Unsignalized Intersection Capacity Analysis

3: Nixon Rd & Barclays Way

11/13/2014

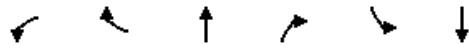

Movement	WBL	WBR	NBT	NBR	SBL	SBT
Lane Configurations	Y		T			T
Volume (veh/h)	74	6	79	25	2	266
Sign Control	Stop		Free			Free
Grade	0%		0%			0%
Peak Hour Factor	0.77	0.77	0.75	0.75	0.86	0.86
Hourly flow rate (vph)	96	8	105	33	2	309
Pedestrians						
Lane Width (ft)						
Walking Speed (ft/s)						
Percent Blockage						
Right turn flare (veh)						
Median type	None			None		
Median storage (veh)						
Upstream signal (ft)						
pX, platoon unblocked						
vC, conflicting volume	436	122			139	
vC1, stage 1 conf vol						
vC2, stage 2 conf vol						
vCu, unblocked vol	436	122			139	
tC, single (s)	6.4	6.2			4.1	
tC, 2 stage (s)						
tF (s)	3.5	3.3			2.2	
p0 queue free %	83	99			100	
cM capacity (veh/h)	577	929			1445	
Direction, Lane #	WB 1	NB 1	SB 1			
Volume Total	104	139	312			
Volume Left	96	0	2			
Volume Right	8	33	0			
cSH	594	1700	1445			
Volume to Capacity	0.18	0.08	0.00			
Queue Length 95th (ft)	16	0	0			
Control Delay (s)	12.3	0.0	0.1			
Lane LOS	B		A			
Approach Delay (s)	12.3	0.0	0.1			
Approach LOS	B					
Intersection Summary						
Average Delay			2.4			
Intersection Capacity Utilization			26.7%	ICU Level of Service	A	
Analysis Period (min)			15			

HCM Unsignalized Intersection Capacity Analysis

3: Nixon Rd & Barclays Way

11/13/2014



Movement	WBL	WBR	NBT	NBR	SBL	SBT
Lane Configurations	Y		T			T
Volume (veh/h)	40	0	314	100	4	75
Sign Control	Stop		Free			Free
Grade	0%		0%			0%
Peak Hour Factor	0.60	0.60	0.88	0.88	0.89	0.89
Hourly flow rate (vph)	67	0	357	114	4	84
Pedestrians						
Lane Width (ft)						
Walking Speed (ft/s)						
Percent Blockage						
Right turn flare (veh)						
Median type	None			None		
Median storage (veh)						
Upstream signal (ft)						
pX, platoon unblocked						
vC, conflicting volume	507	414			470	
vC1, stage 1 conf vol						
vC2, stage 2 conf vol						
vCu, unblocked vol	507	414			470	
tC, single (s)	6.4	6.2			4.1	
tC, 2 stage (s)						
tF (s)	3.5	3.3			2.2	
p0 queue free %	87	100			100	
cM capacity (veh/h)	523	639			1091	

Direction, Lane #	WB 1	NB 1	SB 1
Volume Total	67	470	89
Volume Left	67	0	4
Volume Right	0	114	0
cSH	523	1700	1091
Volume to Capacity	0.13	0.28	0.00
Queue Length 95th (ft)	11	0	0
Control Delay (s)	12.9	0.0	0.5
Lane LOS	B		A
Approach Delay (s)	12.9	0.0	0.5
Approach LOS	B		

Intersection Summary			
Average Delay		1.4	
Intersection Capacity Utilization		32.6%	ICU Level of Service A
Analysis Period (min)		15	

HCM Unsignalized Intersection Capacity Analysis

1: Nixon Rd & Haverhill Court

11/13/2014



Movement	WBL	WBR	NBT	NBR	SBL	SBT
Lane Configurations	Y		T			T
Volume (veh/h)	9	2	206	2	0	550
Sign Control	Stop		Free			Free
Grade	0%		0%			0%
Peak Hour Factor	0.60	0.60	0.73	0.73	0.86	0.86
Hourly flow rate (vph)	15	3	282	3	0	640
Pedestrians						
Lane Width (ft)						
Walking Speed (ft/s)						
Percent Blockage						
Right turn flare (veh)						
Median type	None			None		
Median storage (veh)						
Upstream signal (ft)						
pX, platoon unblocked						
vC, conflicting volume	923	284			285	
vC1, stage 1 conf vol						
vC2, stage 2 conf vol						
vCu, unblocked vol	923	284			285	
tC, single (s)	6.4	6.2			4.1	
tC, 2 stage (s)						
tF (s)	3.5	3.3			2.2	
p0 queue free %	95	100			100	
cM capacity (veh/h)	299	755			1277	









Direction, Lane #	WB 1	NB 1	SB 1
Volume Total	18	285	640
Volume Left	15	0	0
Volume Right	3	3	0
cSH	336	1700	1277
Volume to Capacity	0.05	0.17	0.00
Queue Length 95th (ft)	4	0	0
Control Delay (s)	16.3	0.0	0.0
Lane LOS	C		
Approach Delay (s)	16.3	0.0	0.0
Approach LOS	C		

Intersection Summary			
Average Delay		0.3	
Intersection Capacity Utilization	38.9%	ICU Level of Service	A
Analysis Period (min)	15		

HCM Unsignalized Intersection Capacity Analysis

1: Nixon Rd & Haverhill Court

11/13/2014

						
Movement	WBL	WBR	NBT	NBR	SBL	SBT
Lane Configurations						
Volume (veh/h)	7	0	447	7	4	208
Sign Control	Stop		Free			Free
Grade	0%		0%			0%
Peak Hour Factor	0.60	0.60	0.96	0.96	0.93	0.93
Hourly flow rate (vph)	12	0	466	7	4	224
Pedestrians						
Lane Width (ft)						
Walking Speed (ft/s)						
Percent Blockage						
Right turn flare (veh)						
Median type	None			None		
Median storage (veh)						
Upstream signal (ft)						
pX, platoon unblocked						
vC, conflicting volume	702	469			473	
vC1, stage 1 conf vol						
vC2, stage 2 conf vol						
vCu, unblocked vol	702	469			473	
tC, single (s)	6.4	6.2			4.1	
tC, 2 stage (s)						
tF (s)	3.5	3.3			2.2	
p0 queue free %	97	100			100	
cM capacity (veh/h)	403	594			1089	
Direction, Lane #						
	WB 1	NB 1	SB 1			
Volume Total	12	473	228			
Volume Left	12	0	4			
Volume Right	0	7	0			
cSH	403	1700	1089			
Volume to Capacity	0.03	0.28	0.00			
Queue Length 95th (ft)	2	0	0			
Control Delay (s)	14.2	0.0	0.2			
Lane LOS	B		A			
Approach Delay (s)	14.2	0.0	0.2			
Approach LOS	B					
Intersection Summary						
Average Delay			0.3			
Intersection Capacity Utilization			34.0%	ICU Level of Service		A
Analysis Period (min)			15			

9003: Nixon Rd & Green Road Performance by lane

Lane	WB	WB	NB	SB	All
Movements Served	L	R	TR	LT	
Denied Del/Veh (s)					0.3
Total Del/Veh (s)	7.2	81.2	41.5	1.8	40.1

9004: Nixon Rd & Dhu Varren Rd Performance by lane

Lane	EB	NB	SB	All
Movements Served	LR	LT	TR	
Denied Del/Veh (s)				0.1
Total Del/Veh (s)	6.7	2.2	7.7	3.8

Total Network Performance

Denied Del/Veh (s)	2.6
Total Del/Veh (s)	66.4

9003: Nixon Rd & Green Road Performance by lane

Lane	WB	WB	NB	SB	All
Movements Served	L	R	TR	LT	
Denied Del/Veh (s)					0.4
Total Del/Veh (s)	6.9	7.3	9.7	2.2	5.0

9004: Nixon Rd & Dhu Varren Rd Performance by lane

Lane	EB	NB	SB	All
Movements Served	LR	LT	TR	
Denied Del/Veh (s)				0.5
Total Del/Veh (s)	105.4	2.5	19.0	48.3

Total Network Performance

Denied Del/Veh (s)	0.8
Total Del/Veh (s)	48.4

HCM Unsignalized Intersection Capacity Analysis

9004: Nixon Rd & Dhu Varren Rd

7/7/2014



Movement	EBL	EBR	NBL	NBT	SBT	SBR
Lane Configurations						
Sign Control	Stop			Yield	Stop	
Volume (vph)	13	372	151	122	435	18
Peak Hour Factor	0.95	0.95	0.63	0.63	0.89	0.89
Hourly flow rate (vph)	14	392	240	194	489	20
Direction, Lane #	EB 1	NB 1	SB 1			
Volume Total (vph)	405	433	509			
Volume Left (vph)	14	240	0			
Volume Right (vph)	392	0	20			
Hadj (s)	-0.50	0.21	0.01			
Departure Headway (s)	6.1	6.4	6.1			
Degree Utilization, x	0.69	0.77	0.87			
Capacity (veh/h)	559	544	574			
Control Delay (s)	21.4	28.1	36.3			
Approach Delay (s)	21.4	28.1	36.3			
Approach LOS	C	D	E			
Intersection Summary						
Delay			29.2			
Level of Service			D			
Intersection Capacity Utilization			72.5%	ICU Level of Service	C	
Analysis Period (min)			15			

HCM Unsignalized Intersection Capacity Analysis

9004: Nixon Rd & Dhu Varren Rd

7/7/2014



Movement	EBL	EBR	NBL	NBT	SBT	SBR
Lane Configurations						
Sign Control	Stop			Yield	Stop	
Volume (vph)	20	230	291	513	153	78
Peak Hour Factor	0.83	0.83	0.91	0.91	0.93	0.93
Hourly flow rate (vph)	24	277	320	564	165	84











Direction, Lane #	EB 1	NB 1	SB 1
Volume Total (vph)	301	884	248
Volume Left (vph)	24	320	0
Volume Right (vph)	277	0	84
Hadj (s)	-0.50	0.11	-0.17
Departure Headway (s)	5.7	5.4	5.6
Degree Utilization, x	0.48	1.0	0.39
Capacity (veh/h)	610	675	619
Control Delay (s)	13.9	169.4	12.2
Approach Delay (s)	13.9	169.4	12.2
Approach LOS	B	F	B

Intersection Summary

Delay	109.5
Level of Service	F
Intersection Capacity Utilization	81.2%
ICU Level of Service	D
Analysis Period (min)	15











HCM Unsignalized Intersection Capacity Analysis
 9003: Nixon Rd & Green Road

7/7/2014

						
Movement	WBL	WBR	NBT	NBR	SBL	SBT
Lane Configurations						
Sign Control	Stop		Stop			Yield
Volume (vph)	130	96	177	64	290	517
Peak Hour Factor	0.74	0.74	0.63	0.63	0.89	0.89
Hourly flow rate (vph)	176	130	281	102	326	581
Direction, Lane #	WB 1	WB 2	NB 1	SB 1		
Volume Total (vph)	176	130	383	907		
Volume Left (vph)	176	0	0	326		
Volume Right (vph)	0	130	102	0		
Hadj (s)	0.57	-0.63	-0.06	0.11		
Departure Headway (s)	7.7	6.5	5.8	5.7		
Degree Utilization, x	0.38	0.23	0.62	1.0		
Capacity (veh/h)	456	537	599	643		
Control Delay (s)	14.0	10.3	17.8	218.7		
Approach Delay (s)	12.4		17.8	218.7		
Approach LOS	B		C	F		
Intersection Summary						
Delay			131.0			
Level of Service			F			
Intersection Capacity Utilization			73.7%	ICU Level of Service	D	
Analysis Period (min)			15			

HCM Unsignalized Intersection Capacity Analysis
 9003: Nixon Rd & Green Road

7/9/2014

























						
Movement	WBL	WBR	NBT	NBR	SBL	SBT
Lane Configurations						
Sign Control	Stop		Stop			Yield
Volume (vph)	51	354	449	88	175	208
Peak Hour Factor	0.91	0.91	0.91	0.91	0.93	0.93
Hourly flow rate (vph)	56	389	493	97	188	224
Direction, Lane #	WB 1	WB 2	NB 1	SB 1		
Volume Total (vph)	56	389	590	412		
Volume Left (vph)	56	0	0	188		
Volume Right (vph)	0	389	97	0		
Hadj (s)	0.52	-0.68	-0.06	0.13		
Departure Headway (s)	7.8	6.6	6.2	6.5		
Degree Utilization, x	0.12	0.71	1.0	0.75		
Capacity (veh/h)	451	531	590	539		
Control Delay (s)	10.7	23.3	65.6	26.5		
Approach Delay (s)	21.7		65.6	26.5		
Approach LOS	C		F	D		
Intersection Summary						
Delay			41.0			
Level of Service			E			
Intersection Capacity Utilization			62.9%	ICU Level of Service	B	
Analysis Period (min)			15			

Intersection				
Intersection Delay, s/veh	43.0			
Intersection LOS	E			
Approach	EB	WB	NB	SB
Entry Lanes	1	1	1	1
Conflicting Circle Lanes	1	1	1	1
Adj Approach Flow, veh/h	170	406	240	915
Demand Flow Rate, veh/h	178	418	254	942
Vehicles Circulating, veh/h	889	228	556	245
Vehicles Exiting, veh/h	298	582	511	401
Follow-Up Headway, s	3.186	3.186	3.186	3.186
Ped Vol Crossing Leg, #/h	0	0	0	0
Ped Cap Adj	1.000	1.000	1.000	1.000
Approach Delay, s/veh	15.0	10.0	11.6	71.0
Approach LOS	B	A	B	F
Lane	Left	Left	Left	Left
Designated Moves	LTR	LTR	LTR	LTR
Assumed Moves	LTR	LTR	LTR	LTR
RT Channelized				
Lane Util	1.000	1.000	1.000	1.000
Critical Headway, s	5.193	5.193	5.193	5.193
Entry Flow, veh/h	178	418	254	942
Cap Entry Lane, veh/h	464	900	648	884
Entry HV Adj Factor	0.955	0.971	0.944	0.972
Flow Entry, veh/h	170	406	240	915
Cap Entry, veh/h	443	873	612	859
V/C Ratio	0.383	0.465	0.392	1.065
Control Delay, s/veh	15.0	10.0	11.6	71.0
LOS	B	A	B	F
95th %tile Queue, veh	2	2	2	22

Intersection				
Intersection Delay, s/veh	32.2			
Intersection LOS	D			
Approach	EB	WB	NB	SB
Entry Lanes	1	1	1	1
Conflicting Circle Lanes	1	1	1	1
Adj Approach Flow, veh/h	375	573	562	536
Demand Flow Rate, veh/h	393	590	596	552
Vehicles Circulating, veh/h	576	596	525	262
Vehicles Exiting, veh/h	238	525	444	924
Follow-Up Headway, s	3.186	3.186	3.186	3.186
Ped Vol Crossing Leg, #/h	0	0	0	0
Ped Cap Adj	1.000	1.000	1.000	1.000
Approach Delay, s/veh	18.2	50.7	39.5	14.5
Approach LOS	C	F	E	B
Lane	Left	Left	Left	Left
Designated Moves	LTR	LTR	LTR	LTR
Assumed Moves	LTR	LTR	LTR	LTR
RT Channelized				
Lane Util	1.000	1.000	1.000	1.000
Critical Headway, s	5.193	5.193	5.193	5.193
Entry Flow, veh/h	393	590	596	552
Cap Entry Lane, veh/h	635	623	668	870
Entry HV Adj Factor	0.953	0.971	0.943	0.971
Flow Entry, veh/h	375	573	562	536
Cap Entry, veh/h	605	604	630	844
V/C Ratio	0.619	0.948	0.892	0.635
Control Delay, s/veh	18.2	50.7	39.5	14.5
LOS	C	F	E	B
95th %tile Queue, veh	4	13	11	5

Lanes, Volumes, Timings
1001: Nixon Rd & Plymouth Rd

7/7/2014

												
Lane Group	EBL	EBT	EBR	WBL	WBT	WBR	NBL	NBT	NBR	SBL	SBT	SBR
Lane Configurations		 			 			 			 	
Volume (vph)	88	758	80	14	839	110	14	13	9	189	67	199
Ideal Flow (vphpl)	1900	1900	1900	1900	1900	1900	1900	1900	1900	1900	1900	1900
Storage Length (ft)	135		0	105		0	75		0	95		0
Storage Lanes	1		0	1		0	1		0	1		0
Taper Length (ft)	25			25			25			25		
Lane Util. Factor	1.00	0.95	0.95	1.00	0.95	0.95	1.00	1.00	1.00	1.00	1.00	1.00
Frt		0.986			0.983			0.940			0.888	
Flt Protected	0.950			0.950			0.950			0.950		
Satd. Flow (prot)	1736	3423	0	1752	3445	0	1597	1581	0	1752	1638	0
Flt Permitted	0.950			0.950			0.950			0.950		
Satd. Flow (perm)	1736	3423	0	1752	3445	0	1597	1581	0	1752	1638	0
Right Turn on Red			Yes			Yes			Yes			Yes
Satd. Flow (RTOR)		10			13			12			109	
Link Speed (mph)		35			35			30			30	
Link Distance (ft)		859			966			284			994	
Travel Time (s)		16.7			18.8			6.5			22.6	
Peak Hour Factor	0.94	0.94	0.94	0.92	0.92	0.92	0.73	0.73	0.73	0.79	0.79	0.79
Heavy Vehicles (%)	4%	4%	4%	3%	3%	3%	13%	13%	13%	3%	3%	3%
Adj. Flow (vph)	94	806	85	15	912	120	19	18	12	239	85	252
Shared Lane Traffic (%)												
Lane Group Flow (vph)	94	891	0	15	1032	0	19	30	0	239	337	0
Turn Type	Prot	NA		Prot	NA		Prot	NA		Prot	NA	
Protected Phases	1	6		5	2		7	4		3	8	
Permitted Phases												
Detector Phase	1	6		5	2		7	4		3	8	
Switch Phase												
Minimum Initial (s)	4.0	10.0		8.0	10.0		4.0	7.0		4.0	10.0	
Minimum Split (s)	10.0	19.3		14.0	24.3		10.0	26.5		10.0	26.5	
Total Split (s)	25.0	48.0		23.0	46.0		21.0	28.0		21.0	28.0	
Total Split (%)	20.8%	40.0%		19.2%	38.3%		17.5%	23.3%		17.5%	23.3%	
Yellow Time (s)	3.5	3.6		3.5	3.6		3.5	3.5		3.5	3.5	
All-Red Time (s)	2.5	2.3		2.5	2.3		2.5	2.5		2.5	2.5	
Lost Time Adjust (s)	0.0	0.0		0.0	0.0		0.0	0.0		0.0	0.0	
Total Lost Time (s)	6.0	5.9		6.0	5.9		6.0	6.0		6.0	6.0	
Lead/Lag	Lead	Lag		Lead	Lag		Lead	Lag		Lead	Lag	
Lead-Lag Optimize?												
Recall Mode	None	C-Max		None	C-Max		None	None		None	None	
Act Effect Green (s)	11.8	72.6		8.1	60.5		7.0	12.8		16.2	24.0	
Actuated g/C Ratio	0.10	0.60		0.07	0.50		0.06	0.11		0.14	0.20	
v/c Ratio	0.55	0.43		0.13	0.59		0.20	0.17		1.01	0.81	
Control Delay	63.0	17.0		78.8	13.6		58.2	32.5		113.3	46.0	
Queue Delay	0.0	0.0		0.0	0.0		0.0	0.0		0.0	0.0	
Total Delay	63.0	17.0		78.8	13.6		58.2	32.5		113.3	46.0	
LOS	E	B		E	B		E	C		F	D	
Approach Delay		21.4			14.6			42.5			73.9	
Approach LOS		C			B			D			E	
Queue Length 50th (ft)	71	147		12	294		14	14		-209	166	
Queue Length 95th (ft)	122	343		m21	317		31	30		#305	221	

Lanes, Volumes, Timings
 1001: Nixon Rd & Plymouth Rd

7/7/2014

Lane Group	EBL	EBT	EBR	WBL	WBT	WBR	NBL	NBT	NBR	SBL	SBT	SBR
Internal Link Dist (ft)		779			886			204			914	
Turn Bay Length (ft)	135			105			75			95		
Base Capacity (vph)	274	2075		248	1742		199	299		236	435	
Starvation Cap Reductn	0	0		0	0		0	0		0	0	
Spillback Cap Reductn	0	0		0	0		0	0		0	0	
Storage Cap Reductn	0	0		0	0		0	0		0	0	
Reduced v/c Ratio	0.34	0.43		0.06	0.59		0.10	0.10		1.01	0.77	

Intersection Summary





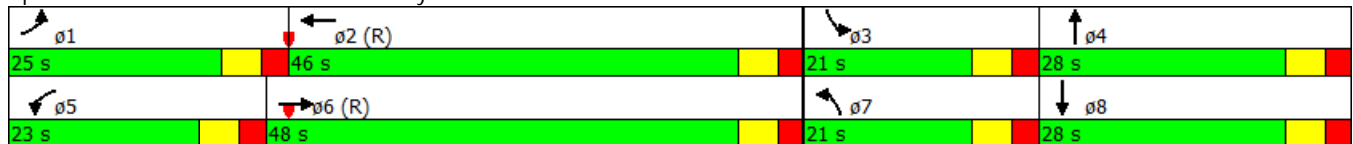



















Area Type: Other
 Cycle Length: 120
 Actuated Cycle Length: 120
 Offset: 42 (35%), Referenced to phase 2:WBT and 6:EBT, Start of Green
 Natural Cycle: 90
 Control Type: Actuated-Coordinated
 Maximum v/c Ratio: 1.01
 Intersection Signal Delay: 30.5 Intersection LOS: C
 Intersection Capacity Utilization 63.6% ICU Level of Service B
 Analysis Period (min) 15
 ~ Volume exceeds capacity, queue is theoretically infinite.
 Queue shown is maximum after two cycles.
 # 95th percentile volume exceeds capacity, queue may be longer.
 Queue shown is maximum after two cycles.
 m Volume for 95th percentile queue is metered by upstream signal.

Splits and Phases: 1001: Nixon Rd & Plymouth Rd



Lanes, Volumes, Timings
1001: Nixon Rd & Plymouth Rd

7/7/2014

												
Lane Group	EBL	EBT	EBR	WBL	WBT	WBR	NBL	NBT	NBR	SBL	SBT	SBR
Lane Configurations		 			 			 			 	
Volume (vph)	224	783	35	13	893	106	93	57	41	261	17	180
Ideal Flow (vphpl)	1900	1900	1900	1900	1900	1900	1900	1900	1900	1900	1900	1900
Storage Length (ft)	135		0	105		0	75		0	95		0
Storage Lanes	1		0	1		0	1		0	1		0
Taper Length (ft)	25			25			25			25		
Lane Util. Factor	1.00	0.95	0.95	1.00	0.95	0.95	1.00	1.00	1.00	1.00	1.00	1.00
Frt		0.994			0.984			0.937				0.863
Flt Protected	0.950			0.950			0.950			0.950		
Satd. Flow (prot)	1770	3518	0	1787	3517	0	1787	1763	0	1770	1608	0
Flt Permitted	0.950			0.950			0.950			0.950		
Satd. Flow (perm)	1770	3518	0	1787	3517	0	1787	1763	0	1770	1608	0
Right Turn on Red			Yes			Yes			Yes			Yes
Satd. Flow (RTOR)		4			12			27			198	
Link Speed (mph)		35			35			30			30	
Link Distance (ft)		859			966			284			994	
Travel Time (s)		16.7			18.8			6.5			22.6	
Peak Hour Factor	0.90	0.90	0.90	0.92	0.92	0.92	0.78	0.78	0.78	0.91	0.91	0.91
Heavy Vehicles (%)	2%	2%	2%	1%	1%	1%	1%	1%	1%	2%	2%	2%
Adj. Flow (vph)	249	870	39	14	971	115	119	73	53	287	19	198
Shared Lane Traffic (%)												
Lane Group Flow (vph)	249	909	0	14	1086	0	119	126	0	287	217	0
Turn Type	Prot	NA		Prot	NA		Prot	NA		Prot	NA	
Protected Phases	1	6		5	2		7	4		3	8	
Permitted Phases												
Detector Phase	1	6		5	2		7	4		3	8	
Switch Phase												
Minimum Initial (s)	4.0	10.0		8.0	10.0		4.0	7.0		4.0	10.0	
Minimum Split (s)	10.0	19.3		14.0	24.3		10.0	26.5		10.0	26.5	
Total Split (s)	21.0	49.0		22.0	50.0		21.0	28.0		21.0	28.0	
Total Split (%)	17.5%	40.8%		18.3%	41.7%		17.5%	23.3%		17.5%	23.3%	
Yellow Time (s)	3.5	3.6		3.5	3.6		3.5	3.5		3.5	3.5	
All-Red Time (s)	2.5	2.3		2.5	2.3		2.5	2.5		2.5	2.5	
Lost Time Adjust (s)	0.0	0.0		0.0	0.0		0.0	0.0		0.0	0.0	
Total Lost Time (s)	6.0	5.9		6.0	5.9		6.0	6.0		6.0	6.0	
Lead/Lag	Lead	Lag		Lead	Lag		Lead	Lag		Lead	Lag	
Lead-Lag Optimize?												
Recall Mode	None	C-Max		None	C-Max		None	None		None	None	
Act Effect Green (s)	24.7	69.3		8.0	44.2		12.5	12.2		15.0	14.7	
Actuated g/C Ratio	0.21	0.58		0.07	0.37		0.10	0.10		0.12	0.12	
v/c Ratio	0.68	0.45		0.12	0.83		0.64	0.62		1.30	0.59	
Control Delay	55.8	17.0		61.8	30.2		66.8	53.1		205.3	15.6	
Queue Delay	0.0	0.0		0.0	0.0		0.0	0.0		0.0	0.0	
Total Delay	55.8	17.0		61.8	30.2		66.8	53.1		205.3	15.6	
LOS	E	B		E	C		E	D		F	B	
Approach Delay		25.4			30.6			59.7			123.6	
Approach LOS		C			C			E			F	
Queue Length 50th (ft)	179	174		11	392		89	74		-284	13	
Queue Length 95th (ft)	#336	324		m18	264		128	110		#460	87	

Lanes, Volumes, Timings
 1001: Nixon Rd & Plymouth Rd

7/7/2014

Lane Group	EBL	EBT	EBR	WBL	WBT	WBR	NBL	NBT	NBR	SBL	SBT	SBR
Internal Link Dist (ft)		779			886			204			914	
Turn Bay Length (ft)	135			105			75			95		
Base Capacity (vph)	364	2032		238	1302		223	345		221	456	
Starvation Cap Reductn	0	0		0	0		0	0		0	0	
Spillback Cap Reductn	0	0		0	0		0	0		0	0	
Storage Cap Reductn	0	0		0	0		0	0		0	0	
Reduced v/c Ratio	0.68	0.45		0.06	0.83		0.53	0.37		1.30	0.48	

Intersection Summary

Area Type: Other
 Cycle Length: 120
 Actuated Cycle Length: 120
 Offset: 42 (35%), Referenced to phase 2:WBT and 6:EBT, Start of Green
 Natural Cycle: 120
 Control Type: Actuated-Coordinated
 Maximum v/c Ratio: 1.30
 Intersection Signal Delay: 46.5 Intersection LOS: D
 Intersection Capacity Utilization 80.7% ICU Level of Service D
 Analysis Period (min) 15
 ~ Volume exceeds capacity, queue is theoretically infinite.
 Queue shown is maximum after two cycles.
 # 95th percentile volume exceeds capacity, queue may be longer.
 Queue shown is maximum after two cycles.
 m Volume for 95th percentile queue is metered by upstream signal.

Splits and Phases: 1001: Nixon Rd & Plymouth Rd

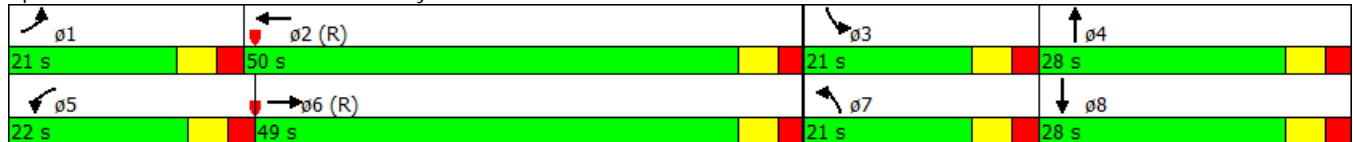

Lanes, Volumes, Timings
1002: Huron Pkwy & Plymouth Rd

7/7/2014

Lane Group	EBL	EBT	EBR	WBL	WBT	WBR	NBL	NBT	NBR	SBL	SBT	SBR
Lane Configurations												
Volume (vph)	2	761	192	37	866	144	90	191	158	221	239	7
Ideal Flow (vphpl)	1900	1900	1900	1900	1900	1900	1900	1900	1900	1900	1900	1900
Storage Length (ft)	120		0	195		0	410		450	120		0
Storage Lanes	1		0	1		0	1		1	1		0
Taper Length (ft)	25			25			25			25		
Lane Util. Factor	1.00	0.95	0.95	1.00	0.95	0.95	1.00	0.95	1.00	1.00	0.95	0.95
Frt		0.970			0.979				0.850		0.996	
Flt Protected	0.950			0.950			0.950			0.950		
Satd. Flow (prot)	1770	3433	0	1770	3465	0	1770	3539	1583	1770	3525	0
Flt Permitted	0.950			0.950			0.950			0.950		
Satd. Flow (perm)	1770	3433	0	1770	3465	0	1770	3539	1583	1770	3525	0
Right Turn on Red			Yes			Yes			Yes			Yes
Satd. Flow (RTOR)		24			18				88			2
Link Speed (mph)		35			35			35				35
Link Distance (ft)		966			889			979				397
Travel Time (s)		18.8			17.3			19.1				7.7
Peak Hour Factor	0.93	0.93	0.93	0.86	0.86	0.86	0.98	0.98	0.98	0.84	0.84	0.84
Adj. Flow (vph)	2	818	206	43	1007	167	92	195	161	263	285	8
Shared Lane Traffic (%)												
Lane Group Flow (vph)	2	1024	0	43	1174	0	92	195	161	263	293	0
Turn Type	Prot	NA		Prot	NA		Prot	NA	pm+ov	Prot	NA	
Protected Phases	1	6		5	2		7	4	5	3	8	
Permitted Phases									4			
Detector Phase	1	6		5	2		7	4	5	3	8	
Switch Phase												
Minimum Initial (s)	4.0	20.0		4.0	10.0		4.0	10.0	4.0	4.0	10.0	
Minimum Split (s)	16.0	34.0		34.0	52.0		23.0	30.0	34.0	22.0	29.0	
Total Split (s)	16.0	34.0		34.0	52.0		23.0	30.0	34.0	22.0	29.0	
Total Split (%)	13.3%	28.3%		28.3%	43.3%		19.2%	25.0%	28.3%	18.3%	24.2%	
Yellow Time (s)	3.6	3.6		4.3	4.3		3.9	3.9	4.3	3.6	3.6	
All-Red Time (s)	2.3	2.5		2.5	2.3		2.5	2.0	2.5	2.5	2.3	
Lost Time Adjust (s)	0.0	0.0		0.0	0.0		0.0	0.0	0.0	0.0	0.0	
Total Lost Time (s)	5.9	6.1		6.8	6.6		6.4	5.9	6.8	6.1	5.9	
Lead/Lag	Lead	Lag		Lead	Lag		Lead	Lag	Lead	Lead	Lag	
Lead-Lag Optimize?												
Recall Mode	None	C-Max		None	C-Max		None	None	None	None	None	
Act Effect Green (s)	5.7	57.5		8.4	69.7		11.5	13.3	27.6	15.9	17.4	
Actuated g/C Ratio	0.05	0.48		0.07	0.58		0.10	0.11	0.23	0.13	0.14	
v/c Ratio	0.02	0.62		0.35	0.58		0.54	0.50	0.37	1.12	0.57	
Control Delay	45.0	25.7		60.2	18.5		62.8	53.9	19.2	143.5	52.4	
Queue Delay	0.0	0.0		0.0	0.0		0.0	0.0	0.0	0.0	0.0	
Total Delay	45.0	25.7		60.2	18.5		62.8	53.9	19.2	143.5	52.4	
LOS	D	C		E	B		E	D	B	F	D	
Approach Delay		25.8			20.0			43.2			95.4	
Approach LOS		C			B			D			F	
Queue Length 50th (ft)	2	196		32	257		69	77	47	-235	113	
Queue Length 95th (ft)	m3	m318		66	436		120	108	97	#365	144	
Internal Link Dist (ft)		886			809			899			317	

Lanes, Volumes, Timings
 1002: Huron Pkwy & Plymouth Rd

7/7/2014

Lane Group	EBL	EBT	EBR	WBL	WBT	WBR	NBL	NBT	NBR	SBL	SBT	SBR
Turn Bay Length (ft)	120			195			410		450	120		
Base Capacity (vph)	148	1657		401	2021		244	710	666	234	680	
Starvation Cap Reductn	0	0		0	0		0	0	0	0	0	
Spillback Cap Reductn	0	0		0	0		0	0	0	0	0	
Storage Cap Reductn	0	0		0	0		0	0	0	0	0	
Reduced v/c Ratio	0.01	0.62		0.11	0.58		0.38	0.27	0.24	1.12	0.43	

Intersection Summary

Area Type: Other

Cycle Length: 120

Actuated Cycle Length: 120

Offset: 40 (33%), Referenced to phase 2:WBT and 6:EBT, Start of Green

Natural Cycle: 130

Control Type: Actuated-Coordinated

Maximum v/c Ratio: 1.12

Intersection Signal Delay: 37.9

Intersection LOS: D

Intersection Capacity Utilization 66.7%

ICU Level of Service C

Analysis Period (min) 15

~ Volume exceeds capacity, queue is theoretically infinite.

Queue shown is maximum after two cycles.

95th percentile volume exceeds capacity, queue may be longer.

Queue shown is maximum after two cycles.



























m Volume for 95th percentile queue is metered by upstream signal.

Splits and Phases: 1002: Huron Pkwy & Plymouth Rd



Lanes, Volumes, Timings
 1002: Huron Pkwy & Plymouth Rd

7/7/2014

												
Lane Group	EBL	EBT	EBR	WBL	WBT	WBR	NBL	NBT	NBR	SBL	SBT	SBR
Lane Configurations		 			 			 			 	
Volume (vph)	20	892	172	113	738	149	249	308	312	229	171	20
Ideal Flow (vphpl)	1900	1900	1900	1900	1900	1900	1900	1900	1900	1900	1900	1900
Storage Length (ft)	120		0	195		0	410		450	120		0
Storage Lanes	1		0	1		0	1		1	1		0
Taper Length (ft)	25			25			25			25		
Lane Util. Factor	1.00	0.95	0.95	1.00	0.95	0.95	1.00	0.95	1.00	1.00	0.95	0.95
Frt		0.976			0.975				0.850		0.984	
Flt Protected	0.950			0.950			0.950			0.950		
Satd. Flow (prot)	1770	3454	0	1770	3451	0	1770	3539	1583	1770	3483	0
Flt Permitted	0.950			0.950			0.950			0.950		
Satd. Flow (perm)	1770	3454	0	1770	3451	0	1770	3539	1583	1770	3483	0
Right Turn on Red			Yes			Yes			Yes			Yes
Satd. Flow (RTOR)		19			21				88			9
Link Speed (mph)		35			35			35			35	
Link Distance (ft)		966			889			979			397	
Travel Time (s)		18.8			17.3			19.1			7.7	
Peak Hour Factor	0.93	0.93	0.93	0.86	0.86	0.86	0.98	0.98	0.98	0.84	0.84	0.84
Adj. Flow (vph)	22	959	185	131	858	173	254	314	318	273	204	24
Shared Lane Traffic (%)												
Lane Group Flow (vph)	22	1144	0	131	1031	0	254	314	318	273	228	0
Turn Type	Prot	NA		Prot	NA		Prot	NA	pm+ov	Prot	NA	
Protected Phases	1	6		5	2		7	4	5	3	8	
Permitted Phases									4			
Detector Phase	1	6		5	2		7	4	5	3	8	
Switch Phase												
Minimum Initial (s)	4.0	20.0		4.0	10.0		4.0	10.0	4.0	4.0	10.0	
Minimum Split (s)	9.9	27.5		10.8	27.3		10.4	26.0	10.8	10.1	25.3	
Total Split (s)	16.0	40.0		23.0	47.0		28.0	30.0	23.0	27.0	29.0	
Total Split (%)	13.3%	33.3%		19.2%	39.2%		23.3%	25.0%	19.2%	22.5%	24.2%	
Yellow Time (s)	3.6	3.6		4.3	4.3		3.9	3.9	4.3	3.6	3.6	
All-Red Time (s)	2.3	2.5		2.5	2.3		2.5	2.0	2.5	2.5	2.3	
Lost Time Adjust (s)	0.0	0.0		0.0	0.0		0.0	0.0	0.0	0.0	0.0	
Total Lost Time (s)	5.9	6.1		6.8	6.6		6.4	5.9	6.8	6.1	5.9	
Lead/Lag	Lead	Lag		Lead	Lag		Lead	Lag	Lead	Lead	Lag	
Lead-Lag Optimize?												
Recall Mode	None	C-Max		None	C-Max		None	None	None	None	None	
Act Effect Green (s)	7.1	44.8		14.1	56.9		20.1	15.9	35.9	20.3	15.8	
Actuated g/C Ratio	0.06	0.37		0.12	0.47		0.17	0.13	0.30	0.17	0.13	
v/c Ratio	0.21	0.88		0.63	0.63		0.86	0.67	0.59	0.91	0.49	
Control Delay	58.1	37.3		63.6	27.3		74.8	56.6	29.2	83.0	49.8	
Queue Delay	0.0	0.0		0.0	0.0		0.0	0.0	0.0	0.0	0.0	
Total Delay	58.1	37.3		63.6	27.3		74.8	56.6	29.2	83.0	49.8	
LOS	E	D		E	C		E	E	C	F	D	
Approach Delay		37.7			31.4			52.0			67.9	
Approach LOS		D			C			D			E	
Queue Length 50th (ft)	18	427		98	326		190	123	152	209	84	
Queue Length 95th (ft)	m34	m#439		149	415		#320	166	220	#322	112	
Internal Link Dist (ft)		886			809			899			317	

Lanes, Volumes, Timings
 1002: Huron Pkwy & Plymouth Rd

7/7/2014

Lane Group	EBL	EBT	EBR	WBL	WBT	WBR	NBL	NBT	NBR	SBL	SBT	SBR
Turn Bay Length (ft)	120			195			410		450	120		
Base Capacity (vph)	148	1301		248	1646		318	710	569	308	677	
Starvation Cap Reductn	0	0		0	0		0	0	0	0	0	
Spillback Cap Reductn	0	0		0	0		0	0	0	0	0	
Storage Cap Reductn	0	0		0	0		0	0	0	0	0	
Reduced v/c Ratio	0.15	0.88		0.53	0.63		0.80	0.44	0.56	0.89	0.34	

Intersection Summary





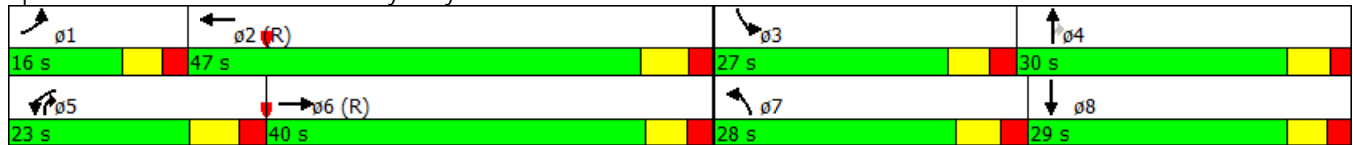













Area Type: Other
 Cycle Length: 120
 Actuated Cycle Length: 120
 Offset: 40 (33%), Referenced to phase 2:WBT and 6:EBT, Start of Green
 Natural Cycle: 100
 Control Type: Actuated-Coordinated
 Maximum v/c Ratio: 0.91
 Intersection Signal Delay: 43.2 Intersection LOS: D
 Intersection Capacity Utilization 79.5% ICU Level of Service D
 Analysis Period (min) 15
 # 95th percentile volume exceeds capacity, queue may be longer.
 Queue shown is maximum after two cycles.
 m Volume for 95th percentile queue is metered by upstream signal.

Splits and Phases: 1002: Huron Pkwy & Plymouth Rd





















HCM Unsignalized Intersection Capacity Analysis
 9002: Nixon Rd & Meade Ct/Bluett Dr

7/7/2014

												
Movement	EBL	EBT	EBR	WBL	WBT	WBR	NBL	NBT	NBR	SBL	SBT	SBR
Lane Configurations												
Sign Control		Stop			Stop			Stop			Stop	
Volume (vph)	2	1	15	109	1	26	2	304	58	34	588	0
Peak Hour Factor	0.85	0.85	0.85	0.56	0.56	0.56	0.76	0.76	0.76	0.80	0.80	0.80
Hourly flow rate (vph)	2	1	18	195	2	46	3	400	76	42	735	0
Direction, Lane #	EB 1	WB 1	NB 1	SB 1	SB 2							
Volume Total (vph)	21	243	479	43	735							
Volume Left (vph)	2	195	3	43	0							
Volume Right (vph)	18	46	76	0	0							
Hadj (s)	-0.48	0.06	-0.06	0.58	0.09							
Departure Headway (s)	7.3	6.8	5.9	6.8	6.3							
Degree Utilization, x	0.04	0.46	0.78	0.08	1.0							
Capacity (veh/h)	439	501	600	523	585							
Control Delay (s)	10.6	15.6	26.8	9.2	157.8							
Approach Delay (s)	10.6	15.6	26.8	149.7								
Approach LOS	B	C	D	F								
Intersection Summary												
Delay			87.6									
Level of Service			F									
Intersection Capacity Utilization			52.0%	ICU Level of Service	A							
Analysis Period (min)			15									

























HCM Unsignalized Intersection Capacity Analysis
 9002: Nixon Rd & Meade Ct/Bluett Dr

7/7/2014

												
Movement	EBL	EBT	EBR	WBL	WBT	WBR	NBL	NBT	NBR	SBL	SBT	SBR
Lane Configurations												
Sign Control		Stop			Stop			Stop			Stop	
Volume (vph)	1	1	13	50	0	16	18	645	63	16	337	1
Peak Hour Factor	0.58	0.58	0.58	0.77	0.77	0.77	0.97	0.97	0.97	0.87	0.87	0.87
Hourly flow rate (vph)	2	2	22	65	0	21	19	665	65	18	387	1
Direction, Lane #	EB 1	WB 1	NB 1	SB 1	SB 2							
Volume Total (vph)	26	86	748	18	389							
Volume Left (vph)	2	65	19	18	0							
Volume Right (vph)	22	21	65	0	1							
Hadj (s)	-0.51	0.04	-0.03	0.52	0.01							
Departure Headway (s)	6.3	6.6	4.9	6.0	5.5							
Degree Utilization, x	0.05	0.16	1.0	0.03	0.60							
Capacity (veh/h)	524	510	736	585	643							
Control Delay (s)	9.6	10.9	60.8	8.0	15.2							
Approach Delay (s)	9.6	10.9	60.8	14.9								
Approach LOS	A	B	F	B								
Intersection Summary												
Delay			41.6									
Level of Service			E									
Intersection Capacity Utilization			69.5%	ICU Level of Service	C							
Analysis Period (min)			15									

Lanes, Volumes, Timings
1001: Nixon Rd & Plymouth Rd

7/10/2014

												
Lane Group	EBL	EBT	EBR	WBL	WBT	WBR	NBL	NBT	NBR	SBL	SBT	SBR
Lane Configurations		 			 			 			 	
Volume (vph)	88	758	80	14	839	110	14	13	9	189	67	199
Ideal Flow (vphpl)	1900	1900	1900	1900	1900	1900	1900	1900	1900	1900	1900	1900
Storage Length (ft)	135		0	105		0	75		0	95		0
Storage Lanes	1		0	1		0	1		0	1		0
Taper Length (ft)	25			25			25			25		
Lane Util. Factor	1.00	0.95	0.95	1.00	0.95	0.95	1.00	1.00	1.00	1.00	1.00	1.00
Frt		0.986			0.983			0.940			0.888	
Flt Protected	0.950			0.950			0.950			0.950		
Satd. Flow (prot)	1736	3423	0	1752	3445	0	1597	1581	0	1752	1638	0
Flt Permitted	0.195			0.253			0.816			0.738		
Satd. Flow (perm)	356	3423	0	467	3445	0	1372	1581	0	1361	1638	0
Right Turn on Red			Yes			Yes			Yes			Yes
Satd. Flow (RTOR)		11			15			12			120	
Link Speed (mph)		35			35			30			30	
Link Distance (ft)		859			966			284			994	
Travel Time (s)		16.7			18.8			6.5			22.6	
Peak Hour Factor	0.94	0.94	0.94	0.92	0.92	0.92	0.73	0.73	0.73	0.79	0.79	0.79
Heavy Vehicles (%)	4%	4%	4%	3%	3%	3%	13%	13%	13%	3%	3%	3%
Adj. Flow (vph)	94	806	85	15	912	120	19	18	12	239	85	252
Shared Lane Traffic (%)												
Lane Group Flow (vph)	94	891	0	15	1032	0	19	30	0	239	337	0
Turn Type	pm+pt	NA		pm+pt	NA		pm+pt	NA		pm+pt	NA	
Protected Phases	1	6		5	2		7	4		3	8	
Permitted Phases	6			2			4			8		
Detector Phase	1	6		5	2		7	4		3	8	
Switch Phase												
Minimum Initial (s)	4.0	10.0		8.0	10.0		4.0	7.0		4.0	10.0	
Minimum Split (s)	10.0	19.3		14.0	24.3		10.0	26.5		10.0	26.5	
Total Split (s)	15.0	56.0		15.0	56.0		12.0	29.0		20.0	37.0	
Total Split (%)	12.5%	46.7%		12.5%	46.7%		10.0%	24.2%		16.7%	30.8%	
Yellow Time (s)	3.5	3.6		3.5	3.6		3.5	3.5		3.5	3.5	
All-Red Time (s)	2.5	2.3		2.5	2.3		2.5	2.5		2.5	2.5	
Lost Time Adjust (s)	0.0	0.0		0.0	0.0		0.0	0.0		0.0	0.0	
Total Lost Time (s)	6.0	5.9		6.0	5.9		6.0	6.0		6.0	6.0	
Lead/Lag	Lag	Lead		Lag	Lead		Lag	Lead		Lag	Lead	
Lead-Lag Optimize?												
Recall Mode	None	C-Max		None	C-Max		None	None		None	None	
Act Effect Green (s)	77.9	74.7		75.8	67.8		10.8	7.7		27.7	22.8	
Actuated g/C Ratio	0.65	0.62		0.63	0.56		0.09	0.06		0.23	0.19	
v/c Ratio	0.31	0.42		0.04	0.53		0.14	0.27		0.64	0.83	
Control Delay	17.2	16.0		16.6	25.1		33.9	42.7		48.3	46.0	
Queue Delay	0.0	0.0		0.0	0.0		0.0	0.0		0.0	0.0	
Total Delay	17.2	16.0		16.6	25.1		33.9	42.7		48.3	46.0	
LOS	B	B		B	C		C	D		D	D	
Approach Delay		16.1			24.9			39.3			47.0	
Approach LOS		B			C			D			D	
Queue Length 50th (ft)	21	129		3	184		11	14		173	165	
Queue Length 95th (ft)	62	346		m14	483		21	34		177	204	

Lanes, Volumes, Timings
 1001: Nixon Rd & Plymouth Rd

7/10/2014

Lane Group	EBL	EBT	EBR	WBL	WBT	WBR	NBL	NBT	NBR	SBL	SBT	SBR
Internal Link Dist (ft)		779			886			204			914	
Turn Bay Length (ft)	135			105			75			95		
Base Capacity (vph)	341	2134		394	1952		136	312		384	512	
Starvation Cap Reductn	0	0		0	0		0	0		0	0	
Spillback Cap Reductn	0	0		0	0		0	0		0	0	
Storage Cap Reductn	0	0		0	0		0	0		0	0	
Reduced v/c Ratio	0.28	0.42		0.04	0.53		0.14	0.10		0.62	0.66	

Intersection Summary

























Area Type: Other
 Cycle Length: 120
 Actuated Cycle Length: 120
 Offset: 0 (0%), Referenced to phase 2:WBTL and 6:EBTL, Start of Green
 Natural Cycle: 80
 Control Type: Actuated-Coordinated
 Maximum v/c Ratio: 0.83
 Intersection Signal Delay: 26.7 Intersection LOS: C
 Intersection Capacity Utilization 63.6% ICU Level of Service B
 Analysis Period (min) 15
 m Volume for 95th percentile queue is metered by upstream signal.

Splits and Phases: 1001: Nixon Rd & Plymouth Rd

φ2 (R) 56 s	φ1 15 s	φ4 29 s	φ3 20 s
φ6 (R) 56 s	φ5 15 s	φ8 37 s	φ7 12 s

Lanes, Volumes, Timings
1001: Nixon Rd & Plymouth Rd

7/10/2014

												
Lane Group	EBL	EBT	EBR	WBL	WBT	WBR	NBL	NBT	NBR	SBL	SBT	SBR
Lane Configurations		 			 			 			 	
Volume (vph)	224	783	35	13	893	106	93	57	41	261	17	180
Ideal Flow (vphpl)	1900	1900	1900	1900	1900	1900	1900	1900	1900	1900	1900	1900
Storage Length (ft)	135		0	105		0	75		0	95		0
Storage Lanes	1		0	1		0	1		0	1		0
Taper Length (ft)	25			25			25			25		
Lane Util. Factor	1.00	0.95	0.95	1.00	0.95	0.95	1.00	1.00	1.00	1.00	1.00	1.00
Frt		0.994			0.984			0.937				0.863
Flt Protected	0.950			0.950			0.950			0.950		
Satd. Flow (prot)	1770	3518	0	1787	3517	0	1787	1763	0	1770	1608	0
Flt Permitted	0.144			0.228			0.328			0.549		
Satd. Flow (perm)	268	3518	0	429	3517	0	617	1763	0	1023	1608	0
Right Turn on Red			Yes			Yes			Yes			Yes
Satd. Flow (RTOR)		5			12			26			198	
Link Speed (mph)		35			35			30			30	
Link Distance (ft)		859			966			284			994	
Travel Time (s)		16.7			18.8			6.5			22.6	
Peak Hour Factor	0.90	0.90	0.90	0.92	0.92	0.92	0.78	0.78	0.78	0.91	0.91	0.91
Heavy Vehicles (%)	2%	2%	2%	1%	1%	1%	1%	1%	1%	2%	2%	2%
Adj. Flow (vph)	249	870	39	14	971	115	119	73	53	287	19	198
Shared Lane Traffic (%)												
Lane Group Flow (vph)	249	909	0	14	1086	0	119	126	0	287	217	0
Turn Type	pm+pt	NA		pm+pt	NA		pm+pt	NA		pm+pt	NA	
Protected Phases	1	6		5	2		7	4		3	8	
Permitted Phases	6			2			4			8		
Detector Phase	1	6		5	2		7	4		3	8	
Switch Phase												
Minimum Initial (s)	4.0	10.0		8.0	10.0		4.0	7.0		4.0	10.0	
Minimum Split (s)	10.0	19.3		14.0	24.3		10.0	26.5		10.0	26.5	
Total Split (s)	23.0	60.0		14.0	51.0		15.0	27.0		19.0	31.0	
Total Split (%)	19.2%	50.0%		11.7%	42.5%		12.5%	22.5%		15.8%	25.8%	
Yellow Time (s)	3.5	3.6		3.5	3.6		3.5	3.5		3.5	3.5	
All-Red Time (s)	2.5	2.3		2.5	2.3		2.5	2.5		2.5	2.5	
Lost Time Adjust (s)	0.0	0.0		0.0	0.0		0.0	0.0		0.0	0.0	
Total Lost Time (s)	6.0	5.9		6.0	5.9		6.0	6.0		6.0	6.0	
Lead/Lag	Lag	Lead		Lag	Lead		Lag	Lead		Lag	Lead	
Lead-Lag Optimize?												
Recall Mode	None	C-Max		None	C-Max		None	None		None	None	
Act Effect Green (s)	74.0	68.5		63.0	55.1		29.0	12.2		27.0	11.2	
Actuated g/C Ratio	0.62	0.57		0.52	0.46		0.24	0.10		0.22	0.09	
v/c Ratio	0.76	0.45		0.04	0.67		0.38	0.62		0.88	0.66	
Control Delay	47.8	18.1		6.6	19.5		41.1	53.5		70.3	19.3	
Queue Delay	0.0	0.0		0.0	0.0		0.0	0.0		0.0	0.0	
Total Delay	47.8	18.1		6.6	19.5		41.1	53.5		70.3	19.3	
LOS	D	B		A	B		D	D		E	B	
Approach Delay		24.5			19.4			47.5			48.4	
Approach LOS		C			B			D			D	
Queue Length 50th (ft)	86	190		2	195		68	75		184	14	
Queue Length 95th (ft)	178	332		m4	276		96	111		#283	89	

Lanes, Volumes, Timings
 1001: Nixon Rd & Plymouth Rd

7/10/2014

Lane Group	EBL	EBT	EBR	WBL	WBT	WBR	NBL	NBT	NBR	SBL	SBT	SBR
Internal Link Dist (ft)		779			886			204			914	
Turn Bay Length (ft)	135			105			75			95		
Base Capacity (vph)	386	2010		315	1621		320	329		338	491	
Starvation Cap Reductn	0	0		0	0		0	0		0	0	
Spillback Cap Reductn	0	0		0	0		0	0		0	0	
Storage Cap Reductn	0	0		0	0		0	0		0	0	
Reduced v/c Ratio	0.65	0.45		0.04	0.67		0.37	0.38		0.85	0.44	

Intersection Summary





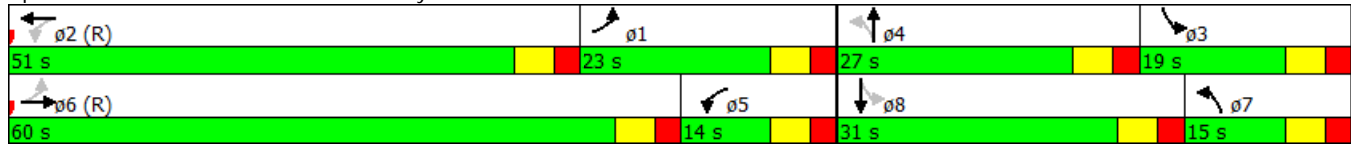





















Area Type: Other
 Cycle Length: 120
 Actuated Cycle Length: 120
 Offset: 42 (35%), Referenced to phase 2:WBTL and 6:EBTL, Start of Green
 Natural Cycle: 90
 Control Type: Actuated-Coordinated
 Maximum v/c Ratio: 0.88
 Intersection Signal Delay: 28.5 Intersection LOS: C
 Intersection Capacity Utilization 80.7% ICU Level of Service D
 Analysis Period (min) 15
 # 95th percentile volume exceeds capacity, queue may be longer.
 Queue shown is maximum after two cycles.
 m Volume for 95th percentile queue is metered by upstream signal.

Splits and Phases: 1001: Nixon Rd & Plymouth Rd



Lanes, Volumes, Timings
1002: Huron Pkwy & Plymouth Rd

7/7/2014

												
Lane Group	EBL	EBT	EBR	WBL	WBT	WBR	NBL	NBT	NBR	SBL	SBT	SBR
Lane Configurations		 			 			 			 	
Volume (vph)	20	892	172	113	738	149	249	308	312	229	171	20
Ideal Flow (vphpl)	1900	1900	1900	1900	1900	1900	1900	1900	1900	1900	1900	1900
Storage Length (ft)	120		0	195		0	410		450	120		0
Storage Lanes	1		0	1		0	1		1	1		0
Taper Length (ft)	25			25			25		25	25		
Lane Util. Factor	1.00	0.95	0.95	1.00	0.95	0.95	1.00	0.95	1.00	1.00	0.95	0.95
Frt		0.976			0.975				0.850		0.984	
Flt Protected	0.950			0.950			0.950		0.950			
Satd. Flow (prot)	1770	3454	0	1770	3451	0	1770	3539	1583	1770	3483	0
Flt Permitted	0.168			0.108			0.543		0.362			
Satd. Flow (perm)	313	3454	0	201	3451	0	1011	3539	1583	674	3483	0
Right Turn on Red			Yes			Yes			Yes			Yes
Satd. Flow (RTOR)		22			26				86		9	
Link Speed (mph)		35			35			35		35		35
Link Distance (ft)		966			889			979		397		
Travel Time (s)		18.8			17.3			19.1		7.7		
Peak Hour Factor	0.93	0.93	0.93	0.86	0.86	0.86	0.98	0.98	0.98	0.84	0.84	0.84
Adj. Flow (vph)	22	959	185	131	858	173	254	314	318	273	204	24
Shared Lane Traffic (%)												
Lane Group Flow (vph)	22	1144	0	131	1031	0	254	314	318	273	228	0
Turn Type	pm+pt	NA		pm+pt	NA		pm+pt	NA	pm+ov	pm+pt	NA	
Protected Phases	1	6		5	2		7	4	5	3	8	
Permitted Phases	6			2			4		4	8		
Detector Phase	1	6		5	2		7	4	5	3	8	
Switch Phase												
Minimum Initial (s)	4.0	20.0		4.0	10.0		4.0	10.0	4.0	4.0	10.0	
Minimum Split (s)	9.9	27.5		10.8	27.3		10.4	26.0	10.8	10.1	25.3	
Total Split (s)	10.0	52.0		20.0	62.0		20.0	26.0	20.0	22.0	28.0	
Total Split (%)	8.3%	43.3%		16.7%	51.7%		16.7%	21.7%	16.7%	18.3%	23.3%	
Yellow Time (s)	3.6	3.6		4.3	4.3		3.9	3.9	4.3	3.6	3.6	
All-Red Time (s)	2.3	2.5		2.5	2.3		2.5	2.0	2.5	2.5	2.3	
Lost Time Adjust (s)	0.0	0.0		0.0	0.0		0.0	0.0	0.0	0.0	0.0	
Total Lost Time (s)	5.9	6.1		6.8	6.6		6.4	5.9	6.8	6.1	5.9	
Lead/Lag	Lag	Lead		Lag	Lead		Lag	Lead	Lag	Lag	Lead	
Lead-Lag Optimize?												
Recall Mode	None	C-Max		None	C-Max		None	None	None	None	None	
Act Effect Green (s)	54.3	50.0		69.2	63.4		34.1	15.9	34.8	29.0	13.0	
Actuated g/C Ratio	0.45	0.42		0.58	0.53		0.28	0.13	0.29	0.24	0.11	
v/c Ratio	0.12	0.79		0.46	0.56		0.63	0.67	0.61	0.88	0.59	
Control Delay	8.5	24.2		35.9	21.6		45.0	56.7	31.4	73.1	55.1	
Queue Delay	0.0	0.0		0.0	0.0		0.0	0.0	0.0	0.0	0.0	
Total Delay	8.5	24.2		35.9	21.6		45.0	56.7	31.4	73.1	55.1	
LOS	A	C		D	C		D	E	C	E	E	
Approach Delay		23.9			23.2			44.2			64.9	
Approach LOS		C			C			D			E	
Queue Length 50th (ft)	5	193		47	298		152	123	155	165	86	
Queue Length 95th (ft)	m6	249		77	353		226	166	242	#246	115	
Internal Link Dist (ft)		886			809			899			317	

Lanes, Volumes, Timings
 1002: Huron Pkwy & Plymouth Rd

7/7/2014

Lane Group	EBL	EBT	EBR	WBL	WBT	WBR	NBL	NBT	NBR	SBL	SBT	SBR
Turn Bay Length (ft)	120			195			410		450	120		
Base Capacity (vph)	191	1452		288	1835		407	592	505	323	648	
Starvation Cap Reductn	0	0		0	0		0	0	0	0	0	
Spillback Cap Reductn	0	0		0	0		0	0	0	0	0	
Storage Cap Reductn	0	0		0	0		0	0	0	0	0	
Reduced v/c Ratio	0.12	0.79		0.45	0.56		0.62	0.53	0.63	0.85	0.35	

Intersection Summary





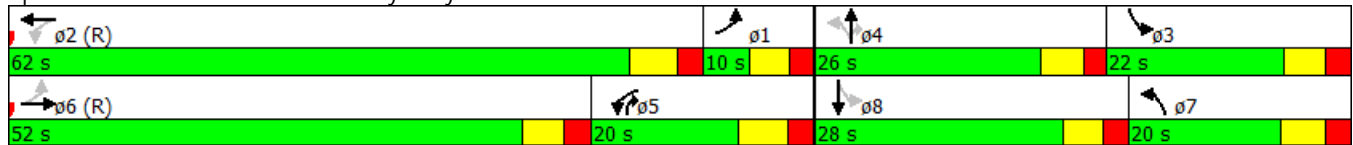

















Area Type: Other
 Cycle Length: 120
 Actuated Cycle Length: 120
 Offset: 40 (33%), Referenced to phase 2:WBTL and 6:EBTL, Start of Green
 Natural Cycle: 90
 Control Type: Actuated-Coordinated
 Maximum v/c Ratio: 0.88
 Intersection Signal Delay: 34.1 Intersection LOS: C
 Intersection Capacity Utilization 79.5% ICU Level of Service D
 Analysis Period (min) 15
 # 95th percentile volume exceeds capacity, queue may be longer.
 Queue shown is maximum after two cycles.
 m Volume for 95th percentile queue is metered by upstream signal.

Splits and Phases: 1002: Huron Pkwy & Plymouth Rd



Lanes, Volumes, Timings
 1002: Huron Pkwy & Plymouth Rd

7/10/2014

													
Lane Group	EBL	EBT	EBR	WBL	WBT	WBR	NBL	NBT	NBR	SBL	SBT	SBR	
Lane Configurations													
Volume (vph)	2	761	192	37	866	144	90	191	158	221	239	7	
Ideal Flow (vphpl)	1900	1900	1900	1900	1900	1900	1900	1900	1900	1900	1900	1900	
Storage Length (ft)	120		0	195		0	410		450	120		0	
Storage Lanes	1		0	1		0	1		1	1		0	
Taper Length (ft)	25			25			25			25			
Lane Util. Factor	1.00	0.95	0.95	1.00	0.95	0.95	1.00	0.95	1.00	1.00	0.95	0.95	
Frt		0.970			0.979				0.850		0.996		
Flt Protected	0.950			0.950			0.950			0.950			
Satd. Flow (prot)	1770	3433	0	1770	3465	0	1770	3539	1583	1770	3525	0	
Flt Permitted	0.151			0.171			0.389			0.604			
Satd. Flow (perm)	281	3433	0	319	3465	0	725	3539	1583	1125	3525	0	
Right Turn on Red			Yes			Yes			Yes			Yes	
Satd. Flow (RTOR)		24			18				107			2	
Link Speed (mph)		35			35			35				35	
Link Distance (ft)		966			889			979				397	
Travel Time (s)		18.8			17.3			19.1				7.7	
Peak Hour Factor	0.93	0.93	0.93	0.86	0.86	0.86	0.98	0.98	0.98	0.84	0.84	0.84	
Adj. Flow (vph)	2	818	206	43	1007	167	92	195	161	263	285	8	
Shared Lane Traffic (%)													
Lane Group Flow (vph)	2	1024	0	43	1174	0	92	195	161	263	293	0	
Turn Type	pm+pt	NA		pm+pt	NA		pm+pt	NA	pm+ov	pm+pt	NA		
Protected Phases	1	6		5	2		7	4	5	3	8		
Permitted Phases	6			2			4		4	8			
Detector Phase	1	6		5	2		7	4	5	3	8		
Switch Phase													
Minimum Initial (s)	4.0	20.0		4.0	10.0		4.0	10.0	4.0	4.0	10.0		
Minimum Split (s)	16.0	34.0		34.0	52.0		23.0	30.0	34.0	22.0	29.0		
Total Split (s)	16.0	34.0		34.0	52.0		23.0	30.0	34.0	22.0	29.0		
Total Split (%)	13.3%	28.3%		28.3%	43.3%		19.2%	25.0%	28.3%	18.3%	24.2%		
Yellow Time (s)	3.6	3.6		4.3	4.3		3.9	3.9	4.3	3.6	3.6		
All-Red Time (s)	2.3	2.5		2.5	2.3		2.5	2.0	2.5	2.5	2.3		
Lost Time Adjust (s)	0.0	0.0		0.0	0.0		0.0	0.0	0.0	0.0	0.0		
Total Lost Time (s)	5.9	6.1		6.8	6.6		6.4	5.9	6.8	6.1	5.9		
Lead/Lag	Lag	Lead		Lag	Lead		Lag	Lead	Lag	Lag	Lead		
Lead-Lag Optimize?													
Recall Mode	None	C-Max		None	C-Max		None	None	None	None	None		
Act Effect Green (s)	62.9	57.2		76.8	74.7		20.6	12.2	31.6	27.2	15.2		
Actuated g/C Ratio	0.52	0.48		0.64	0.62		0.17	0.10	0.26	0.23	0.13		
v/c Ratio	0.01	0.62		0.12	0.54		0.46	0.54	0.33	0.82	0.66		
Control Delay	7.0	21.1		12.4	15.5		47.0	56.8	13.7	64.1	56.5		
Queue Delay	0.0	0.0		0.0	0.0		0.0	0.0	0.0	0.0	0.0		
Total Delay	7.0	21.1		12.4	15.5		47.0	56.8	13.7	64.1	56.5		
LOS	A	C		B	B		D	E	B	E	E		
Approach Delay		21.1			15.4			39.3			60.1		
Approach LOS		C			B			D			E		
Queue Length 50th (ft)	1	138		11	232		57	77	33	181	114		
Queue Length 95th (ft)	m1	#134		29	411		93	113	76	224	144		
Internal Link Dist (ft)		886			809			899			317		

Lanes, Volumes, Timings
 1002: Huron Pkwy & Plymouth Rd

7/10/2014

Lane Group	EBL	EBT	EBR	WBL	WBT	WBR	NBL	NBT	NBR	SBL	SBT	SBR
Turn Bay Length (ft)	120			195			410		450	120		
Base Capacity (vph)	283	1648		569	2163		315	710	490	379	680	
Starvation Cap Reductn	0	0		0	0		0	0	0	0	0	
Spillback Cap Reductn	0	0		0	0		0	0	0	0	0	
Storage Cap Reductn	0	0		0	0		0	0	0	0	0	
Reduced v/c Ratio	0.01	0.62		0.08	0.54		0.29	0.27	0.33	0.69	0.43	

Intersection Summary

Area Type: Other
 Cycle Length: 120
 Actuated Cycle Length: 120
 Offset: 40 (33%), Referenced to phase 2:WBTL and 6:EBTL, Start of Green
 Natural Cycle: 120
 Control Type: Actuated-Coordinated
 Maximum v/c Ratio: 0.82
 Intersection Signal Delay: 28.1 Intersection LOS: C
 Intersection Capacity Utilization 66.7% ICU Level of Service C
 Analysis Period (min) 15
 # 95th percentile volume exceeds capacity, queue may be longer.
 Queue shown is maximum after two cycles.
 m Volume for 95th percentile queue is metered by upstream signal.

Splits and Phases: 1002: Huron Pkwy & Plymouth Rd

φ2 (R) 52 s	φ1 16 s	φ4 30 s	φ3 22 s
φ6 (R) 34 s	φ5 34 s	φ8 29 s	φ7 23 s

HCM Unsignalized Intersection Capacity Analysis

3: Nixon Rd & Barclays Way

11/13/2014



Movement	WBL	WBR	NBT	NBR	SBL	SBT
Lane Configurations	Y		T			T
Volume (veh/h)	92	7	104	31	2	361
Sign Control	Stop		Free			Free
Grade	0%		0%			0%
Peak Hour Factor	0.77	0.77	0.75	0.75	0.86	0.86
Hourly flow rate (vph)	119	9	139	41	2	420
Pedestrians						
Lane Width (ft)						
Walking Speed (ft/s)						
Percent Blockage						
Right turn flare (veh)						
Median type	None			None		
Median storage (veh)						
Upstream signal (ft)						
pX, platoon unblocked						
vC, conflicting volume	584	159			180	
vC1, stage 1 conf vol						
vC2, stage 2 conf vol						
vCu, unblocked vol	584	159			180	
tC, single (s)	6.4	6.2			4.1	
tC, 2 stage (s)						
tF (s)	3.5	3.3			2.2	
p0 queue free %	75	99			100	
cM capacity (veh/h)	473	886			1396	
Direction, Lane #	WB 1	NB 1	SB 1			
Volume Total	129	180	422			
Volume Left	119	0	2			
Volume Right	9	41	0			
cSH	489	1700	1396			
Volume to Capacity	0.26	0.11	0.00			
Queue Length 95th (ft)	26	0	0			
Control Delay (s)	15.0	0.0	0.1			
Lane LOS	B		A			
Approach Delay (s)	15.0	0.0	0.1			
Approach LOS	B					
Intersection Summary						
Average Delay			2.7			
Intersection Capacity Utilization			32.8%	ICU Level of Service	A	
Analysis Period (min)			15			

HCM Unsignalized Intersection Capacity Analysis

3: Nixon Rd & Barclays Way

11/13/2014



Movement	WBL	WBR	NBT	NBR	SBL	SBT
Lane Configurations	Y		Y			Y
Volume (veh/h)	50	0	408	124	5	121
Sign Control	Stop		Free			Free
Grade	0%		0%			0%
Peak Hour Factor	0.60	0.60	0.88	0.88	0.89	0.89
Hourly flow rate (vph)	83	0	464	141	6	136
Pedestrians						
Lane Width (ft)						
Walking Speed (ft/s)						
Percent Blockage						
Right turn flare (veh)						
Median type	None			None		
Median storage (veh)						
Upstream signal (ft)						
pX, platoon unblocked						
vC, conflicting volume	681	534			605	
vC1, stage 1 conf vol						
vC2, stage 2 conf vol						
vCu, unblocked vol	681	534			605	
tC, single (s)	6.4	6.2			4.1	
tC, 2 stage (s)						
tF (s)	3.5	3.3			2.2	
p0 queue free %	80	100			99	
cM capacity (veh/h)	413	546			973	

Direction, Lane #	WB 1	NB 1	SB 1
Volume Total	83	605	142
Volume Left	83	0	6
Volume Right	0	141	0
cSH	413	1700	973
Volume to Capacity	0.20	0.36	0.01
Queue Length 95th (ft)	19	0	0
Control Delay (s)	15.9	0.0	0.4
Lane LOS	C		A
Approach Delay (s)	15.9	0.0	0.4
Approach LOS	C		

Intersection Summary			
Average Delay			1.7
Intersection Capacity Utilization	39.0%	ICU Level of Service	A
Analysis Period (min)			15

HCM Unsignalized Intersection Capacity Analysis

1: Nixon Rd & Haverhill Court

11/13/2014



Movement	WBL	WBR	NBT	NBR	SBL	SBT
Lane Configurations	Y		T			T
Volume (veh/h)	11	2	241	2	0	647
Sign Control	Stop		Free			Free
Grade	0%		0%			0%
Peak Hour Factor	0.60	0.60	0.73	0.73	0.86	0.86
Hourly flow rate (vph)	18	3	330	3	0	752
Pedestrians						
Lane Width (ft)						
Walking Speed (ft/s)						
Percent Blockage						
Right turn flare (veh)						
Median type	None			None		
Median storage (veh)						
Upstream signal (ft)						
pX, platoon unblocked						
vC, conflicting volume	1084	332			333	
vC1, stage 1 conf vol						
vC2, stage 2 conf vol						
vCu, unblocked vol	1084	332			333	
tC, single (s)	6.4	6.2			4.1	
tC, 2 stage (s)						
tF (s)	3.5	3.3			2.2	
p0 queue free %	92	100			100	
cM capacity (veh/h)	240	710			1226	
Direction, Lane #						
	WB 1	NB 1	SB 1			
Volume Total	22	333	752			
Volume Left	18	0	0			
Volume Right	3	3	0			
cSH	267	1700	1226			
Volume to Capacity	0.08	0.20	0.00			
Queue Length 95th (ft)	7	0	0			
Control Delay (s)	19.6	0.0	0.0			
Lane LOS	C					
Approach Delay (s)	19.6	0.0	0.0			
Approach LOS	C					
Intersection Summary						
Average Delay			0.4			
Intersection Capacity Utilization		44.1%		ICU Level of Service		A
Analysis Period (min)			15			

HCM Unsignalized Intersection Capacity Analysis

1: Nixon Rd & Haverhill Court

11/13/2014



Movement	WBL	WBR	NBT	NBR	SBL	SBT
Lane Configurations	Y		B			Y
Volume (veh/h)	9	0	537	9	5	254
Sign Control	Stop		Free			Free
Grade	0%		0%			0%
Peak Hour Factor	0.60	0.60	0.96	0.96	0.93	0.93
Hourly flow rate (vph)	15	0	559	9	5	273
Pedestrians						
Lane Width (ft)						
Walking Speed (ft/s)						
Percent Blockage						
Right turn flare (veh)						
Median type	None			None		
Median storage (veh)						
Upstream signal (ft)						
pX, platoon unblocked						
vC, conflicting volume	848	564			569	
vC1, stage 1 conf vol						
vC2, stage 2 conf vol						
vCu, unblocked vol	848	564			569	
tC, single (s)	6.4	6.2			4.1	
tC, 2 stage (s)						
tF (s)	3.5	3.3			2.2	
p0 queue free %	95	100			99	
cM capacity (veh/h)	330	525			1004	

Direction, Lane #	WB 1	NB 1	SB 1
Volume Total	15	569	278
Volume Left	15	0	5
Volume Right	0	9	0
cSH	330	1700	1004
Volume to Capacity	0.05	0.33	0.01
Queue Length 95th (ft)	4	0	0
Control Delay (s)	16.4	0.0	0.2
Lane LOS	C		A
Approach Delay (s)	16.4	0.0	0.2
Approach LOS	C		

Intersection Summary			
Average Delay		0.4	
Intersection Capacity Utilization	38.8%	ICU Level of Service	A
Analysis Period (min)	15		

9003: Nixon Rd & Green Road Performance by lane

Lane	WB	WB	NB	SB	All
Movements Served	L	R	TR	LT	
Denied Del/Veh (s)					44.6
Total Del/Veh (s)	8.6	311.9	251.2	2.3	190.1

9004: Nixon Rd & Dhu Varren Rd Performance by lane

Lane	EB	NB	SB	All
Movements Served	LR	LT	TR	
Denied Del/Veh (s)				0.1
Total Del/Veh (s)	8.7	2.4	9.7	5.2

Total Network Performance

Denied Del/Veh (s)	24.0
Total Del/Veh (s)	126.9

9003: Nixon Rd & Green Road Performance by lane

Lane	WB	WB	NB	SB	All
Movements Served	L	R	TR	LT	
Denied Del/Veh (s)					0.4
Total Del/Veh (s)	7.2	9.7	13.3	2.7	6.5

9004: Nixon Rd & Dhu Varren Rd Performance by lane

























Lane	EB	NB	SB	All
Movements Served	LR	LT	TR	
Denied Del/Veh (s)				104.8
Total Del/Veh (s)	405.2	2.8	90.7	164.2

Total Network Performance

Denied Del/Veh (s)	29.4
Total Del/Veh (s)	84.2

Lanes, Volumes, Timings
1001: Nixon Rd & Plymouth Rd

11/19/2014

												
Lane Group	EBL	EBT	EBR	WBL	WBT	WBR	NBL	NBT	NBR	SBL	SBT	SBR
Lane Configurations		 			 			 			 	
Volume (vph)	98	758	80	14	839	110	14	15	9	189	79	232
Ideal Flow (vphpl)	1900	1900	1900	1900	1900	1900	1900	1900	1900	1900	1900	1900
Storage Length (ft)	135		0	105		0	75		0	95		0
Storage Lanes	1		0	1		0	1		0	1		0
Taper Length (ft)	25			25			25			25		
Lane Util. Factor	1.00	0.95	0.95	1.00	0.95	0.95	1.00	1.00	1.00	1.00	1.00	1.00
Frt		0.986			0.983			0.945			0.888	
Flt Protected	0.950			0.950			0.950			0.950		
Satd. Flow (prot)	1736	3423	0	1752	3445	0	1597	1589	0	1752	1638	0
Flt Permitted	0.950			0.950			0.950			0.950		
Satd. Flow (perm)	1736	3423	0	1752	3445	0	1597	1589	0	1752	1638	0
Right Turn on Red			Yes			Yes			Yes			Yes
Satd. Flow (RTOR)		10			13			12			108	
Link Speed (mph)		35			35			30			30	
Link Distance (ft)		859			966			284			994	
Travel Time (s)		16.7			18.8			6.5			22.6	
Peak Hour Factor	0.94	0.94	0.94	0.92	0.92	0.92	0.73	0.73	0.73	0.79	0.79	0.79
Heavy Vehicles (%)	4%	4%	4%	3%	3%	3%	13%	13%	13%	3%	3%	3%
Adj. Flow (vph)	104	806	85	15	912	120	19	21	12	239	100	294
Shared Lane Traffic (%)												
Lane Group Flow (vph)	104	891	0	15	1032	0	19	33	0	239	394	0
Turn Type	Prot	NA		Prot	NA		Prot	NA		Prot	NA	
Protected Phases	1	6		5	2		7	4		3	8	
Permitted Phases												
Detector Phase	1	6		5	2		7	4		3	8	
Switch Phase												
Minimum Initial (s)	4.0	10.0		8.0	10.0		4.0	7.0		4.0	10.0	
Minimum Split (s)	10.0	19.3		14.0	24.3		10.0	26.5		10.0	26.5	
Total Split (s)	25.0	48.0		23.0	46.0		21.0	28.0		21.0	28.0	
Total Split (%)	20.8%	40.0%		19.2%	38.3%		17.5%	23.3%		17.5%	23.3%	
Yellow Time (s)	3.5	3.6		3.5	3.6		3.5	3.5		3.5	3.5	
All-Red Time (s)	2.5	2.3		2.5	2.3		2.5	2.5		2.5	2.5	
Lost Time Adjust (s)	0.0	0.0		0.0	0.0		0.0	0.0		0.0	0.0	
Total Lost Time (s)	6.0	5.9		6.0	5.9		6.0	6.0		6.0	6.0	
Lead/Lag	Lead	Lag		Lead	Lag		Lead	Lag		Lead	Lag	
Lead-Lag Optimize?												
Recall Mode	None	C-Max		None	C-Max		None	None		None	None	
Act Effect Green (s)	12.5	66.7		8.1	53.9		7.0	13.8		21.1	30.0	
Actuated g/C Ratio	0.10	0.56		0.07	0.45		0.06	0.12		0.18	0.25	
v/c Ratio	0.58	0.47		0.13	0.66		0.20	0.17		0.78	0.81	
Control Delay	63.3	19.3		79.1	17.4		58.2	33.0		66.9	44.4	
Queue Delay	0.0	0.0		0.0	0.0		0.0	0.0		0.0	0.0	
Total Delay	63.3	19.3		79.1	17.4		58.2	33.0		66.9	44.4	
LOS	E	B		E	B		E	C		E	D	
Approach Delay		23.9			18.2			42.2			52.9	
Approach LOS		C			B			D			D	
Queue Length 50th (ft)	78	165		12	317		14	15		-209	208	
Queue Length 95th (ft)	131	343		m21	302		31	33		#305	279	

Lanes, Volumes, Timings
 1001: Nixon Rd & Plymouth Rd

11/19/2014

Lane Group	EBL	EBT	EBR	WBL	WBT	WBR	NBL	NBT	NBR	SBL	SBT	SBR
Internal Link Dist (ft)		779			886			204			914	
Turn Bay Length (ft)	135			105			75			95		
Base Capacity (vph)	274	1907		248	1553		199	301		308	489	
Starvation Cap Reductn	0	0		0	0		0	0		0	0	
Spillback Cap Reductn	0	0		0	0		0	0		0	0	
Storage Cap Reductn	0	0		0	0		0	0		0	0	
Reduced v/c Ratio	0.38	0.47		0.06	0.66		0.10	0.11		0.78	0.81	

Intersection Summary





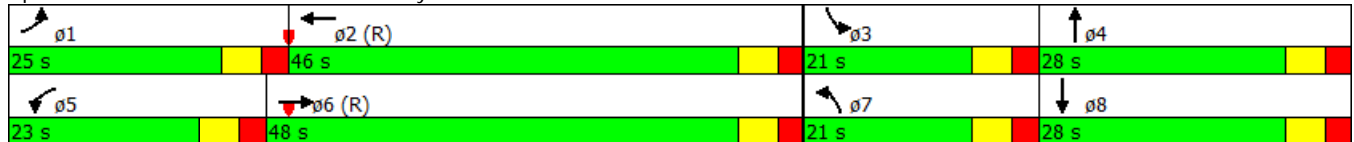

















Area Type: Other
 Cycle Length: 120
 Actuated Cycle Length: 120
 Offset: 42 (35%), Referenced to phase 2:WBT and 6:EBT, Start of Green
 Natural Cycle: 90
 Control Type: Actuated-Coordinated
 Maximum v/c Ratio: 0.81
 Intersection Signal Delay: 28.8 Intersection LOS: C
 Intersection Capacity Utilization 65.5% ICU Level of Service C
 Analysis Period (min) 15
 ~ Volume exceeds capacity, queue is theoretically infinite.
 Queue shown is maximum after two cycles.
 # 95th percentile volume exceeds capacity, queue may be longer.
 Queue shown is maximum after two cycles.
 m Volume for 95th percentile queue is metered by upstream signal.

Splits and Phases: 1001: Nixon Rd & Plymouth Rd



Lanes, Volumes, Timings
 1002: Huron Pkwy & Plymouth Rd

11/19/2014

												
Lane Group	EBL	EBT	EBR	WBL	WBT	WBR	NBL	NBT	NBR	SBL	SBT	SBR
Lane Configurations												
Volume (vph)	2	761	192	37	866	150	90	199	158	242	262	7
Ideal Flow (vphpl)	1900	1900	1900	1900	1900	1900	1900	1900	1900	1900	1900	1900
Storage Length (ft)	120		0	195		0	410		450	120		0
Storage Lanes	1		0	1		0	1		1	1		0
Taper Length (ft)	25			25			25			25		
Lane Util. Factor	1.00	0.95	0.95	1.00	0.95	0.95	1.00	0.95	1.00	1.00	0.95	0.95
Frt		0.970			0.978				0.850		0.996	
Flt Protected	0.950			0.950			0.950			0.950		
Satd. Flow (prot)	1770	3433	0	1770	3461	0	1770	3539	1583	1770	3525	0
Flt Permitted	0.950			0.950			0.950			0.950		
Satd. Flow (perm)	1770	3433	0	1770	3461	0	1770	3539	1583	1770	3525	0
Right Turn on Red			Yes			Yes			Yes			Yes
Satd. Flow (RTOR)		24			19				88			2
Link Speed (mph)		35			35			35				35
Link Distance (ft)		966			889			979				397
Travel Time (s)		18.8			17.3			19.1				7.7
Peak Hour Factor	0.93	0.93	0.93	0.86	0.86	0.86	0.98	0.98	0.98	0.84	0.84	0.84
Adj. Flow (vph)	2	818	206	43	1007	174	92	203	161	288	312	8
Shared Lane Traffic (%)												
Lane Group Flow (vph)	2	1024	0	43	1181	0	92	203	161	288	320	0
Turn Type	Prot	NA		Prot	NA		Prot	NA	pm+ov	Prot	NA	
Protected Phases	1	6		5	2		7	4	5	3	8	
Permitted Phases									4			
Detector Phase	1	6		5	2		7	4	5	3	8	
Switch Phase												
Minimum Initial (s)	4.0	20.0		4.0	10.0		4.0	10.0	4.0	4.0	10.0	
Minimum Split (s)	16.0	34.0		34.0	52.0		23.0	30.0	34.0	22.0	29.0	
Total Split (s)	16.0	34.0		34.0	52.0		23.0	30.0	34.0	22.0	29.0	
Total Split (%)	13.3%	28.3%		28.3%	43.3%		19.2%	25.0%	28.3%	18.3%	24.2%	
Yellow Time (s)	3.6	3.6		4.3	4.3		3.9	3.9	4.3	3.6	3.6	
All-Red Time (s)	2.3	2.5		2.5	2.3		2.5	2.0	2.5	2.5	2.3	
Lost Time Adjust (s)	0.0	0.0		0.0	0.0		0.0	0.0	0.0	0.0	0.0	
Total Lost Time (s)	5.9	6.1		6.8	6.6		6.4	5.9	6.8	6.1	5.9	
Lead/Lag	Lead	Lag		Lead	Lag		Lead	Lag	Lead	Lead	Lag	
Lead-Lag Optimize?												
Recall Mode	None	C-Max		None	C-Max		None	None	None	None	None	
Act Effect Green (s)	5.7	57.0		8.4	69.2		11.5	13.9	28.1	15.9	17.9	
Actuated g/C Ratio	0.05	0.48		0.07	0.58		0.10	0.12	0.23	0.13	0.15	
v/c Ratio	0.02	0.62		0.35	0.59		0.54	0.50	0.37	1.23	0.61	
Control Delay	45.5	25.5		60.2	19.1		62.8	53.2	18.8	178.9	52.7	
Queue Delay	0.0	0.0		0.0	0.0		0.0	0.0	0.0	0.0	0.0	
Total Delay	45.5	25.5		60.2	19.1		62.8	53.2	18.8	178.9	52.7	
LOS	D	C		E	B		E	D	B	F	D	
Approach Delay		25.6			20.5			43.0			112.5	
Approach LOS		C			C			D			F	
Queue Length 50th (ft)	2	196		32	262		69	80	47	-275	124	
Queue Length 95th (ft)	m3	329		66	448		120	111	96	#407	155	
Internal Link Dist (ft)		886			809			899			317	

Lanes, Volumes, Timings
 1002: Huron Pkwy & Plymouth Rd

11/19/2014

Lane Group	EBL	EBT	EBR	WBL	WBT	WBR	NBL	NBT	NBR	SBL	SBT	SBR
Turn Bay Length (ft)	120			195			410		450	120		
Base Capacity (vph)	148	1642		401	2004		244	710	672	234	680	
Starvation Cap Reductn	0	0		0	0		0	0	0	0	0	
Spillback Cap Reductn	0	0		0	0		0	0	0	0	0	
Storage Cap Reductn	0	0		0	0		0	0	0	0	0	
Reduced v/c Ratio	0.01	0.62		0.11	0.59		0.38	0.29	0.24	1.23	0.47	

Intersection Summary

Area Type: Other
 Cycle Length: 120
 Actuated Cycle Length: 120
 Offset: 40 (33%), Referenced to phase 2:WBT and 6:EBT, Start of Green
 Natural Cycle: 140
 Control Type: Actuated-Coordinated
 Maximum v/c Ratio: 1.23
 Intersection Signal Delay: 42.0 Intersection LOS: D
 Intersection Capacity Utilization 67.8% ICU Level of Service C
 Analysis Period (min) 15
 ~ Volume exceeds capacity, queue is theoretically infinite.
 Queue shown is maximum after two cycles.
 # 95th percentile volume exceeds capacity, queue may be longer.
 Queue shown is maximum after two cycles.
 m Volume for 95th percentile queue is metered by upstream signal.



















Splits and Phases: 1002: Huron Pkwy & Plymouth Rd



Intersection				
Intersection Delay, s/veh	58.6			
Intersection LOS	F			
Approach	EB	WB	NB	SB
Entry Lanes	1	1	1	1
Conflicting Circle Lanes	1	1	1	1
Adj Approach Flow, veh/h	173	423	253	982
Demand Flow Rate, veh/h	181	436	268	1012
Vehicles Circulating, veh/h	950	245	615	245
Vehicles Exiting, veh/h	307	638	516	436
Follow-Up Headway, s	3.186	3.186	3.186	3.186
Ped Vol Crossing Leg, #/h	0	0	0	0
Ped Cap Adj	1.000	1.000	1.000	1.000
Approach Delay, s/veh	16.7	10.7	13.2	98.3
Approach LOS	C	B	B	F
Lane	Left	Left	Left	Left
Designated Moves	LTR	LTR	LTR	LTR
Assumed Moves	LTR	LTR	LTR	LTR
RT Channelized				
Lane Util	1.000	1.000	1.000	1.000
Critical Headway, s	5.193	5.193	5.193	5.193
Entry Flow, veh/h	181	436	268	1012
Cap Entry Lane, veh/h	437	884	611	884
Entry HV Adj Factor	0.955	0.970	0.944	0.970
Flow Entry, veh/h	173	423	253	982
Cap Entry, veh/h	417	858	577	858
V/C Ratio	0.414	0.493	0.439	1.144
Control Delay, s/veh	16.7	10.7	13.2	98.3
LOS	C	B	B	F
95th %tile Queue, veh	2	3	2	28



















HCM Unsignalized Intersection Capacity Analysis
 9002: Nixon Rd & Meade Ct/Bluett Dr

11/19/2014

												
Movement	EBL	EBT	EBR	WBL	WBT	WBR	NBL	NBT	NBR	SBL	SBT	SBR
Lane Configurations												
Volume (veh/h)	2	1	15	109	1	29	2	332	58	40	684	0
Sign Control		Stop			Stop			Free			Free	
Grade		0%			0%			0%			0%	
Peak Hour Factor	0.85	0.85	0.85	0.56	0.56	0.56	0.76	0.76	0.76	0.80	0.80	0.80
Hourly flow rate (vph)	2	1	18	195	2	52	3	437	76	50	855	0
Pedestrians												
Lane Width (ft)												
Walking Speed (ft/s)												
Percent Blockage												
Right turn flare (veh)												
Median type								None			None	
Median storage (veh)												
Upstream signal (ft)												
pX, platoon unblocked												
vC, conflicting volume	1488	1473	855	1453	1435	475	855			513		
vC1, stage 1 conf vol												
vC2, stage 2 conf vol												
vCu, unblocked vol	1488	1473	855	1453	1435	475	855			513		
tC, single (s)	7.1	6.5	6.2	7.1	6.5	6.2	4.1			4.1		
tC, 2 stage (s)												
tF (s)	3.5	4.0	3.3	3.5	4.0	3.3	2.2			2.2		
p0 queue free %	97	99	95	0	99	91	100			95		
cM capacity (veh/h)	90	121	361	99	127	592	785			1037		
Direction, Lane #	EB 1	WB 1	NB 1	SB 1	SB 2							
Volume Total	21	248	516	50	855							
Volume Left	2	195	3	50	0							
Volume Right	18	52	76	0	0							
cSH	250	120	785	1037	1700							
Volume to Capacity	0.08	2.08	0.00	0.05	0.50							
Queue Length 95th (ft)	7	515	0	4	0							
Control Delay (s)	20.8	571.4	0.1	8.6	0.0							
Lane LOS	C	F	A	A								
Approach Delay (s)	20.8	571.4	0.1	0.5								
Approach LOS	C	F										
Intersection Summary												
Average Delay			84.5									
Intersection Capacity Utilization			57.2%		ICU Level of Service					B		
Analysis Period (min)			15									

















HCM Unsignalized Intersection Capacity Analysis
 9003: Nixon Rd & Dhu Varren/Green Road

11/19/2014

													
Movement	EBL	EBT	EBR	WBL	WBT	WBR	NBL	NBT	NBR	SBL	SBT	SBR	
Lane Configurations													
Volume (veh/h)	22	176	250	135	65	41	111	103	81	148	340	30	
Sign Control		Stop			Stop			Free			Free		
Grade		0%			0%			0%			0%		
Peak Hour Factor	0.95	0.95	0.95	0.74	0.74	0.74	0.63	0.63	0.63	0.89	0.89	0.89	
Hourly flow rate (vph)	23	185	263	182	88	55	176	163	129	166	382	34	
Pedestrians													
Lane Width (ft)													
Walking Speed (ft/s)													
Percent Blockage													
Right turn flare (veh)													
Median type							None						
Median storage (veh)													
Upstream signal (ft)													
pX, platoon unblocked													
vC, conflicting volume	1411	1376	399	1667	1328	228	416			292			
vC1, stage 1 conf vol													
vC2, stage 2 conf vol													
vCu, unblocked vol	1411	1376	399	1667	1328	228	416			292			
tC, single (s)	7.1	6.5	6.2	7.1	6.5	6.2	4.2			4.1			
tC, 2 stage (s)													
tF (s)	3.5	4.0	3.3	3.5	4.0	3.3	2.3			2.2			
p0 queue free %	27	0	59	0	22	93	84			87			
cM capacity (veh/h)	32	106	649	0	112	807	1122			1270			
Direction, Lane #	EB 1	EB 2	WB 1	WB 2	NB 1	SB 1							
Volume Total	23	448	182	143	468	582							
Volume Left	23	0	182	0	176	166							
Volume Right	0	263	0	55	129	34							
cSH	32	208	0	169	1122	1270							
Volume to Capacity	0.73	2.16	Err	0.85	0.16	0.13							
Queue Length 95th (ft)	62	872	Err	148	14	11							
Control Delay (s)	262.7	573.4	Err	89.0	4.4	3.4							
Lane LOS	F	F	F	F	A	A							
Approach Delay (s)	558.2		Err		4.4	3.4							
Approach LOS	F		F										
Intersection Summary													
Average Delay			Err										
Intersection Capacity Utilization			75.4%		ICU Level of Service		D						
Analysis Period (min)			15										

















HCM Unsignalized Intersection Capacity Analysis
 9004: Nixon Rd & Proposed North Dr/Barclays Way

11/19/2014

													
Movement	EBL	EBT	EBR	WBL	WBT	WBR	NBL	NBT	NBR	SBL	SBT	SBR	
Lane Configurations													
Volume (veh/h)	7	0	61	92	0	7	18	117	31	2	365	2	
Sign Control		Stop			Stop			Free			Free		
Grade		0%			0%			0%			0%		
Peak Hour Factor	0.92	0.92	0.92	0.92	0.92	0.92	0.63	0.63	0.92	0.92	0.89	0.89	
Hourly flow rate (vph)	8	0	66	100	0	8	29	186	34	2	410	2	
Pedestrians													
Lane Width (ft)													
Walking Speed (ft/s)													
Percent Blockage													
Right turn flare (veh)													
Median type							None						
Median storage (veh)													
Upstream signal (ft)													
pX, platoon unblocked													
vC, conflicting volume	683	692	411	742	676	203	412					219	
vC1, stage 1 conf vol													
vC2, stage 2 conf vol													
vCu, unblocked vol	683	692	411	742	676	203	412					219	
tC, single (s)	7.1	6.5	6.2	7.1	6.5	6.2	4.2					4.1	
tC, 2 stage (s)													
tF (s)	3.5	4.0	3.3	3.5	4.0	3.3	2.3					2.2	
p0 queue free %	98	100	90	66	100	99	97					100	
cM capacity (veh/h)	353	357	641	291	365	838	1125					1350	
Direction, Lane #	EB 1	WB 1	NB 1	SB 1									
Volume Total	74	108	248	415									
Volume Left	8	100	29	2									
Volume Right	66	8	34	2									
cSH	591	305	1125	1350									
Volume to Capacity	0.13	0.35	0.03	0.00									
Queue Length 95th (ft)	11	38	2	0									
Control Delay (s)	12.0	23.1	1.2	0.1									
Lane LOS	B	C	A	A									
Approach Delay (s)	12.0	23.1	1.2	0.1									
Approach LOS	B	C											
Intersection Summary													
Average Delay			4.4										
Intersection Capacity Utilization			40.4%	ICU Level of Service	A								
Analysis Period (min)			15										

















HCM Unsignalized Intersection Capacity Analysis
 9005: Nixon Rd & Proposed South Dr/Haverhill Court

11/19/2014

												
Movement	EBL	EBT	EBR	WBL	WBT	WBR	NBL	NBT	NBR	SBL	SBT	SBR
Lane Configurations												
Volume (veh/h)	34	0	34	11	0	2	11	259	2	0	715	10
Sign Control		Stop			Stop			Free			Free	
Grade		0%			0%			0%			0%	
Peak Hour Factor	0.92	0.92	0.92	0.92	0.92	0.92	0.63	0.63	0.92	0.92	0.89	0.89
Hourly flow rate (vph)	37	0	37	12	0	2	17	411	2	0	803	11
Pedestrians												
Lane Width (ft)												
Walking Speed (ft/s)												
Percent Blockage												
Right turn flare (veh)												
Median type								None			None	
Median storage (veh)												
Upstream signal (ft)												
pX, platoon unblocked												
vC, conflicting volume	1258	1257	809	1293	1262	412	815			413		
vC1, stage 1 conf vol												
vC2, stage 2 conf vol												
vCu, unblocked vol	1258	1257	809	1293	1262	412	815			413		
tC, single (s)	7.1	6.5	6.2	7.1	6.5	6.2	4.2			4.1		
tC, 2 stage (s)												
tF (s)	3.5	4.0	3.3	3.5	4.0	3.3	2.3			2.2		
p0 queue free %	74	100	90	90	100	100	98			100		
cM capacity (veh/h)	145	167	380	124	166	640	795			1146		
Direction, Lane #	EB 1	WB 1	NB 1	SB 1								
Volume Total	74	14	431	815								
Volume Left	37	12	17	0								
Volume Right	37	2	2	11								
cSH	210	142	795	1146								
Volume to Capacity	0.35	0.10	0.02	0.00								
Queue Length 95th (ft)	38	8	2	0								
Control Delay (s)	31.2	33.2	0.7	0.0								
Lane LOS	D	D	A									
Approach Delay (s)	31.2	33.2	0.7	0.0								
Approach LOS	D	D										
Intersection Summary												
Average Delay			2.3									
Intersection Capacity Utilization			48.7%		ICU Level of Service					A		
Analysis Period (min)			15									





















HCM Unsignalized Intersection Capacity Analysis
 9006: Proposed Dr & Dhu Varren

11/19/2014

												
Movement	EBL	EBT	EBR	WBL	WBT	WBR	NBL	NBT	NBR	SBL	SBT	SBR
Lane Configurations												
Volume (veh/h)	1	391	2	8	189	9	5	0	29	28	0	6
Sign Control		Free			Free			Stop			Stop	
Grade		0%			0%			0%			0%	
Peak Hour Factor	0.95	0.95	0.95	0.95	0.95	0.95	0.92	0.92	0.92	0.92	0.92	0.92
Hourly flow rate (vph)	1	412	2	8	199	9	5	0	32	30	0	7
Pedestrians												
Lane Width (ft)												
Walking Speed (ft/s)												
Percent Blockage												
Right turn flare (veh)												
Median type		None			None							
Median storage (veh)												
Upstream signal (ft)												
pX, platoon unblocked												
vC, conflicting volume	208			414			642	640	413	667	636	204
vC1, stage 1 conf vol												
vC2, stage 2 conf vol												
vCu, unblocked vol	208			414			642	640	413	667	636	204
tC, single (s)	4.1			4.1			7.1	6.5	6.2	7.1	6.5	6.2
tC, 2 stage (s)												
tF (s)	2.2			2.2			3.5	4.0	3.3	3.5	4.0	3.3
p0 queue free %	100			99			99	100	95	91	100	99
cM capacity (veh/h)	1351			1135			382	390	639	352	392	837
Direction, Lane #	EB 1	WB 1	NB 1	SB 1								
Volume Total	415	217	37	37								
Volume Left	1	8	5	30								
Volume Right	2	9	32	7								
cSH	1351	1135	582	392								
Volume to Capacity	0.00	0.01	0.06	0.09								
Queue Length 95th (ft)	0	1	5	8								
Control Delay (s)	0.0	0.4	11.6	15.1								
Lane LOS	A	A	B	C								
Approach Delay (s)	0.0	0.4	11.6	15.1								
Approach LOS			B	C								
Intersection Summary												
Average Delay			1.5									
Intersection Capacity Utilization			35.3%		ICU Level of Service				A			
Analysis Period (min)			15									

Lanes, Volumes, Timings
1001: Nixon Rd & Plymouth Rd

11/19/2014

												
Lane Group	EBL	EBT	EBR	WBL	WBT	WBR	NBL	NBT	NBR	SBL	SBT	SBR
Lane Configurations												
Volume (vph)	249	783	35	13	893	106	93	64	41	261	19	199
Ideal Flow (vphpl)	1900	1900	1900	1900	1900	1900	1900	1900	1900	1900	1900	1900
Storage Length (ft)	135		0	105		0	75		0	95		0
Storage Lanes	1		0	1		0	1		0	1		0
Taper Length (ft)	25			25			25			25		
Lane Util. Factor	1.00	0.95	0.95	1.00	0.95	0.95	1.00	1.00	1.00	1.00	1.00	1.00
Frt		0.994			0.984			0.941				0.863
Flt Protected	0.950			0.950			0.950			0.950		
Satd. Flow (prot)	1770	3518	0	1787	3517	0	1787	1770	0	1770	1608	0
Flt Permitted	0.950			0.950			0.950			0.950		
Satd. Flow (perm)	1770	3518	0	1787	3517	0	1787	1770	0	1770	1608	0
Right Turn on Red			Yes			Yes			Yes			Yes
Satd. Flow (RTOR)		4			12			24			219	
Link Speed (mph)		35			35			30			30	
Link Distance (ft)		859			966			284			994	
Travel Time (s)		16.7			18.8			6.5			22.6	
Peak Hour Factor	0.90	0.90	0.90	0.92	0.92	0.92	0.78	0.78	0.78	0.91	0.91	0.91
Heavy Vehicles (%)	2%	2%	2%	1%	1%	1%	1%	1%	1%	2%	2%	2%
Adj. Flow (vph)	277	870	39	14	971	115	119	82	53	287	21	219
Shared Lane Traffic (%)												
Lane Group Flow (vph)	277	909	0	14	1086	0	119	135	0	287	240	0
Turn Type	Prot	NA		Prot	NA		Prot	NA		Prot	NA	
Protected Phases	1	6		5	2		7	4		3	8	
Permitted Phases												
Detector Phase	1	6		5	2		7	4		3	8	
Switch Phase												
Minimum Initial (s)	4.0	10.0		8.0	10.0		4.0	7.0		4.0	10.0	
Minimum Split (s)	10.0	19.3		14.0	24.3		10.0	26.5		10.0	26.5	
Total Split (s)	21.0	49.0		22.0	50.0		21.0	28.0		21.0	28.0	
Total Split (%)	17.5%	40.8%		18.3%	41.7%		17.5%	23.3%		17.5%	23.3%	
Yellow Time (s)	3.5	3.6		3.5	3.6		3.5	3.5		3.5	3.5	
All-Red Time (s)	2.5	2.3		2.5	2.3		2.5	2.5		2.5	2.5	
Lost Time Adjust (s)	0.0	0.0		0.0	0.0		0.0	0.0		0.0	0.0	
Total Lost Time (s)	6.0	5.9		6.0	5.9		6.0	6.0		6.0	6.0	
Lead/Lag	Lead	Lag		Lead	Lag		Lead	Lag		Lead	Lag	
Lead-Lag Optimize?												
Recall Mode	None	C-Max		None	C-Max		None	None		None	None	
Act Effect Green (s)	24.1	68.6		8.0	44.1		12.5	12.9		15.0	15.4	
Actuated g/C Ratio	0.20	0.57		0.07	0.37		0.10	0.11		0.12	0.13	
v/c Ratio	0.78	0.45		0.12	0.84		0.64	0.64		1.30	0.61	
Control Delay	62.7	17.5		61.9	30.3		66.8	55.0		205.3	15.3	
Queue Delay	0.0	0.0		0.0	0.0		0.0	0.0		0.0	0.0	
Total Delay	62.7	17.5		61.9	30.3		66.8	55.0		205.3	15.3	
LOS	E	B		E	C		E	E		F	B	
Approach Delay		28.1			30.7			60.5			118.8	
Approach LOS		C			C			E			F	
Queue Length 50th (ft)	205	177		11	356		89	83		-284	15	
Queue Length 95th (ft)	#398	329		m17	281		128	120		#460	92	

Lanes, Volumes, Timings
 1001: Nixon Rd & Plymouth Rd

11/19/2014

Lane Group	EBL	EBT	EBR	WBL	WBT	WBR	NBL	NBT	NBR	SBL	SBT	SBR
Internal Link Dist (ft)		779			886			204			914	
Turn Bay Length (ft)	135			105			75			95		
Base Capacity (vph)	355	2011		238	1300		223	344		221	473	
Starvation Cap Reductn	0	0		0	0		0	0		0	0	
Spillback Cap Reductn	0	0		0	0		0	0		0	0	
Storage Cap Reductn	0	0		0	0		0	0		0	0	
Reduced v/c Ratio	0.78	0.45		0.06	0.84		0.53	0.39		1.30	0.51	

Intersection Summary





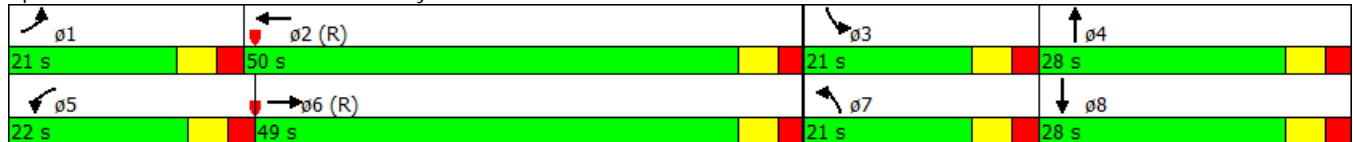





















Area Type: Other
 Cycle Length: 120
 Actuated Cycle Length: 120
 Offset: 42 (35%), Referenced to phase 2:WBT and 6:EBT, Start of Green
 Natural Cycle: 110
 Control Type: Actuated-Coordinated
 Maximum v/c Ratio: 1.30
 Intersection Signal Delay: 47.3 Intersection LOS: D
 Intersection Capacity Utilization 82.1% ICU Level of Service E
 Analysis Period (min) 15
 ~ Volume exceeds capacity, queue is theoretically infinite.
 Queue shown is maximum after two cycles.
 # 95th percentile volume exceeds capacity, queue may be longer.
 Queue shown is maximum after two cycles.
 m Volume for 95th percentile queue is metered by upstream signal.

Splits and Phases: 1001: Nixon Rd & Plymouth Rd



Lanes, Volumes, Timings
1002: Huron Pkwy & Plymouth Rd

11/19/2014

												
Lane Group	EBL	EBT	EBR	WBL	WBT	WBR	NBL	NBT	NBR	SBL	SBT	SBR
Lane Configurations		 			 			 			 	
Volume (vph)	20	892	172	113	738	157	249	325	312	236	177	26
Ideal Flow (vphpl)	1900	1900	1900	1900	1900	1900	1900	1900	1900	1900	1900	1900
Storage Length (ft)	120		0	195		0	410		450	120		0
Storage Lanes	1		0	1		0	1		1	1		0
Taper Length (ft)	25			25			25			25		
Lane Util. Factor	1.00	0.95	0.95	1.00	0.95	0.95	1.00	0.95	1.00	1.00	0.95	0.95
Frt		0.976			0.974				0.850		0.981	
Flt Protected	0.950			0.950			0.950			0.950		
Satd. Flow (prot)	1770	3454	0	1770	3447	0	1770	3539	1583	1770	3472	0
Flt Permitted	0.950			0.950			0.950			0.950		
Satd. Flow (perm)	1770	3454	0	1770	3447	0	1770	3539	1583	1770	3472	0
Right Turn on Red			Yes			Yes			Yes			Yes
Satd. Flow (RTOR)		19			23				88		12	
Link Speed (mph)		35			35			35		35		35
Link Distance (ft)		966			889			979		397		
Travel Time (s)		18.8			17.3			19.1		7.7		
Peak Hour Factor	0.93	0.93	0.93	0.86	0.86	0.86	0.98	0.98	0.98	0.84	0.84	0.84
Adj. Flow (vph)	22	959	185	131	858	183	254	332	318	281	211	31
Shared Lane Traffic (%)												
Lane Group Flow (vph)	22	1144	0	131	1041	0	254	332	318	281	242	0
Turn Type	Prot	NA		Prot	NA		Prot	NA	pm+ov	Prot	NA	
Protected Phases	1	6		5	2		7	4	5	3	8	
Permitted Phases									4			
Detector Phase	1	6		5	2		7	4	5	3	8	
Switch Phase												
Minimum Initial (s)	4.0	20.0		4.0	10.0		4.0	10.0	4.0	4.0	10.0	
Minimum Split (s)	9.9	27.5		10.8	27.3		10.4	26.0	10.8	10.1	25.3	
Total Split (s)	16.0	40.0		23.0	47.0		28.0	30.0	23.0	27.0	29.0	
Total Split (%)	13.3%	33.3%		19.2%	39.2%		23.3%	25.0%	19.2%	22.5%	24.2%	
Yellow Time (s)	3.6	3.6		4.3	4.3		3.9	3.9	4.3	3.6	3.6	
All-Red Time (s)	2.3	2.5		2.5	2.3		2.5	2.0	2.5	2.5	2.3	
Lost Time Adjust (s)	0.0	0.0		0.0	0.0		0.0	0.0	0.0	0.0	0.0	
Total Lost Time (s)	5.9	6.1		6.8	6.6		6.4	5.9	6.8	6.1	5.9	
Lead/Lag	Lead	Lag		Lead	Lag		Lead	Lag	Lead	Lead	Lag	
Lead-Lag Optimize?												
Recall Mode	None	C-Max		None	C-Max		None	None	None	None	None	
Act Effect Green (s)	7.1	44.0		14.1	56.1		20.1	16.5	36.5	20.5	16.6	
Actuated g/C Ratio	0.06	0.37		0.12	0.47		0.17	0.14	0.30	0.17	0.14	
v/c Ratio	0.21	0.90		0.63	0.64		0.86	0.68	0.59	0.93	0.49	
Control Delay	58.4	39.0		63.6	28.0		74.8	56.5	28.6	85.8	48.7	
Queue Delay	0.0	0.0		0.0	0.0		0.0	0.0	0.0	0.0	0.0	
Total Delay	58.4	39.0		63.6	28.0		74.8	56.5	28.6	85.8	48.7	
LOS	E	D		E	C		E	E	C	F	D	
Approach Delay		39.4			32.0			51.8			68.6	
Approach LOS		D			C			D			E	
Queue Length 50th (ft)	18	430		98	334		190	130	150	216	88	
Queue Length 95th (ft)	m33	m#575		149	424		#320	174	218	#337	116	
Internal Link Dist (ft)		886			809			899			317	

Lanes, Volumes, Timings
 1002: Huron Pkwy & Plymouth Rd

11/19/2014

Lane Group	EBL	EBT	EBR	WBL	WBT	WBR	NBL	NBT	NBR	SBL	SBT	SBR
Turn Bay Length (ft)	120			195			410		450	120		
Base Capacity (vph)	148	1278		248	1623		318	710	576	308	678	
Starvation Cap Reductn	0	0		0	0		0	0	0	0	0	
Spillback Cap Reductn	0	0		0	0		0	0	0	0	0	
Storage Cap Reductn	0	0		0	0		0	0	0	0	0	
Reduced v/c Ratio	0.15	0.90		0.53	0.64		0.80	0.47	0.55	0.91	0.36	

Intersection Summary

Area Type: Other
 Cycle Length: 120
 Actuated Cycle Length: 120
 Offset: 40 (33%), Referenced to phase 2:WBT and 6:EBT, Start of Green
 Natural Cycle: 100
 Control Type: Actuated-Coordinated
 Maximum v/c Ratio: 0.93
 Intersection Signal Delay: 44.1 Intersection LOS: D
 Intersection Capacity Utilization 79.5% ICU Level of Service D
 Analysis Period (min) 15
 # 95th percentile volume exceeds capacity, queue may be longer.
 Queue shown is maximum after two cycles.
 m Volume for 95th percentile queue is metered by upstream signal.

Splits and Phases: 1002: Huron Pkwy & Plymouth Rd

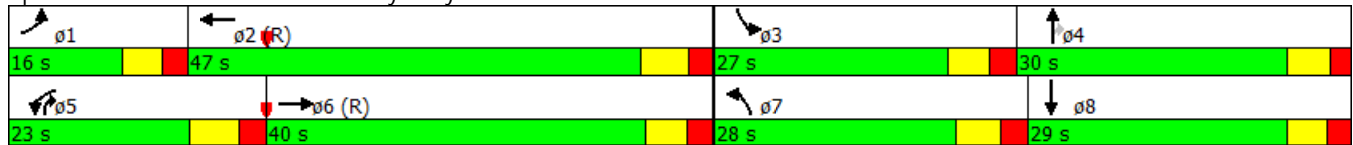



















Intersection				
Intersection Delay, s/veh	44.1			
Intersection LOS	E			
Approach	EB	WB	NB	SB
Entry Lanes	1	1	1	1
Conflicting Circle Lanes	1	1	1	1
Adj Approach Flow, veh/h	383	603	596	579
Demand Flow Rate, veh/h	401	621	632	596
Vehicles Circulating, veh/h	618	640	548	262
Vehicles Exiting, veh/h	240	540	471	999
Follow-Up Headway, s	3.186	3.186	3.186	3.186
Ped Vol Crossing Leg, #/h	0	0	0	0
Ped Cap Adj	1.000	1.000	1.000	1.000
Approach Delay, s/veh	20.6	75.6	54.3	16.4
Approach LOS	C	F	F	C
Lane	Left	Left	Left	Left
Designated Moves	LTR	LTR	LTR	LTR
Assumed Moves	LTR	LTR	LTR	LTR
RT Channelized				
Lane Util	1.000	1.000	1.000	1.000
Critical Headway, s	5.193	5.193	5.193	5.193
Entry Flow, veh/h	401	621	632	596
Cap Entry Lane, veh/h	609	596	653	870
Entry HV Adj Factor	0.954	0.971	0.943	0.972
Flow Entry, veh/h	383	603	596	579
Cap Entry, veh/h	581	578	616	845
V/C Ratio	0.658	1.042	0.968	0.685
Control Delay, s/veh	20.6	75.6	54.3	16.4
LOS	C	F	F	C
95th %tile Queue, veh	5	17	14	6

HCM Unsignalized Intersection Capacity Analysis



















9002: Nixon Rd & Meade Ct/Bluett Dr

11/19/2014

												
Movement	EBL	EBT	EBR	WBL	WBT	WBR	NBL	NBT	NBR	SBL	SBT	SBR
Lane Configurations												
Volume (veh/h)	1	1	13	50	0	18	18	709	63	18	373	1
Sign Control		Stop			Stop			Free			Free	
Grade		0%			0%			0%			0%	
Peak Hour Factor	0.58	0.58	0.58	0.77	0.77	0.77	0.97	0.97	0.97	0.87	0.87	0.87
Hourly flow rate (vph)	2	2	22	65	0	23	19	731	65	21	429	1
Pedestrians												
Lane Width (ft)												
Walking Speed (ft/s)												
Percent Blockage												
Right turn flare (veh)												
Median type							None			None		
Median storage (veh)												
Upstream signal (ft)												
pX, platoon unblocked												
vC, conflicting volume	1295	1304	429	1294	1272	763	430				796	
vC1, stage 1 conf vol												
vC2, stage 2 conf vol												
vCu, unblocked vol	1295	1304	429	1294	1272	763	430				796	
tC, single (s)	7.1	6.5	6.2	7.1	6.5	6.2	4.1				4.1	
tC, 2 stage (s)												
tF (s)	3.5	4.0	3.3	3.5	4.0	3.3	2.2				2.2	
p0 queue free %	99	99	96	50	100	94	98				98	
cM capacity (veh/h)	128	155	630	129	161	404	1135				830	
Direction, Lane #	EB 1	WB 1	NB 1	SB 1	SB 2							
Volume Total	26	88	814	21	430							
Volume Left	2	65	19	21	0							
Volume Right	22	23	65	0	1							
cSH	430	158	1135	830	1700							
Volume to Capacity	0.06	0.56	0.02	0.02	0.25							
Queue Length 95th (ft)	5	72	1	2	0							
Control Delay (s)	13.9	53.6	0.4	9.4	0.0							
Lane LOS	B	F	A	A								
Approach Delay (s)	13.9	53.6	0.4	0.4								
Approach LOS	B	F										
Intersection Summary												
Average Delay			4.1									
Intersection Capacity Utilization			73.0%	ICU Level of Service								C
Analysis Period (min)			15									

















HCM Unsignalized Intersection Capacity Analysis
 9003: Nixon Rd & Dhu Varren Rd/Green Road

11/19/2014

												
Movement	EBL	EBT	EBR	WBL	WBT	WBR	NBL	NBT	NBR	SBL	SBT	SBR
Lane Configurations												
Volume (veh/h)	35	133	130	67	180	208	156	346	98	61	119	29
Sign Control		Stop			Stop			Free			Free	
Grade		0%			0%			0%			0%	
Peak Hour Factor	0.83	0.83	0.83	0.91	0.91	0.91	0.91	0.91	0.91	0.93	0.93	0.93
Hourly flow rate (vph)	42	160	157	74	198	229	171	380	108	66	128	31
Pedestrians												
Lane Width (ft)												
Walking Speed (ft/s)												
Percent Blockage												
Right turn flare (veh)												
Median type								None			None	
Median storage (veh)												
Upstream signal (ft)												
pX, platoon unblocked												
vC, conflicting volume	1379	1106	144	1288	1067	434	159			488		
vC1, stage 1 conf vol												
vC2, stage 2 conf vol												
vCu, unblocked vol	1379	1106	144	1288	1067	434	159			488		
tC, single (s)	7.1	6.5	6.2	7.1	6.5	6.2	4.1			4.1		
tC, 2 stage (s)												
tF (s)	3.5	4.0	3.3	3.5	4.0	3.3	2.2			2.2		
p0 queue free %	0	8	83	0	0	63	88			94		
cM capacity (veh/h)	0	174	904	20	184	624	1420			1075		
Direction, Lane #	EB 1	EB 2	WB 1	WB 2	NB 1	SB 1						
Volume Total	42	317	74	426	659	225						
Volume Left	42	0	74	0	171	66						
Volume Right	0	157	0	229	108	31						
cSH	0	289	20	296	1420	1075						
Volume to Capacity	Err	1.09	3.62	1.44	0.12	0.06						
Queue Length 95th (ft)	Err	319	Err	580	10	5						
Control Delay (s)	Err	119.9	Err	249.8	3.0	2.9						
Lane LOS	F	F	F	F	A	A						
Approach Delay (s)	Err		1685.4		3.0	2.9						
Approach LOS	F		F									
Intersection Summary												
Average Delay				Err								
Intersection Capacity Utilization			77.4%		ICU Level of Service					D		
Analysis Period (min)			15									

















HCM Unsignalized Intersection Capacity Analysis
 9004: Nixon Rd & Proposed North Dr/Barclays Way

11/19/2014

												
Movement	EBL	EBT	EBR	WBL	WBT	WBR	NBL	NBT	NBR	SBL	SBT	SBR
Lane Configurations												
Volume (veh/h)	3	0	28	50	0	0	49	416	124	5	131	6
Sign Control		Stop			Stop			Free			Free	
Grade		0%			0%			0%			0%	
Peak Hour Factor	0.92	0.92	0.92	0.60	0.60	0.60	0.88	0.88	0.88	0.89	0.89	0.89
Hourly flow rate (vph)	3	0	30	83	0	0	56	473	141	6	147	7
Pedestrians												
Lane Width (ft)												
Walking Speed (ft/s)												
Percent Blockage												
Right turn flare (veh)												
Median type								None			None	
Median storage (veh)												
Upstream signal (ft)												
pX, platoon unblocked												
vC, conflicting volume	816	887	151	847	820	543	154			614		
vC1, stage 1 conf vol												
vC2, stage 2 conf vol												
vCu, unblocked vol	816	887	151	847	820	543	154			614		
tC, single (s)	7.1	6.5	6.2	7.1	6.5	6.2	4.1			4.1		
tC, 2 stage (s)												
tF (s)	3.5	4.0	3.3	3.5	4.0	3.3	2.2			2.2		
p0 queue free %	99	100	97	68	100	100	96			99		
cM capacity (veh/h)	285	271	896	263	296	540	1426			966		
Direction, Lane #	EB 1	WB 1	NB 1	SB 1								
Volume Total	34	83	669	160								
Volume Left	3	83	56	6								
Volume Right	30	0	141	7								
cSH	742	263	1426	966								
Volume to Capacity	0.05	0.32	0.04	0.01								
Queue Length 95th (ft)	4	33	3	0								
Control Delay (s)	10.1	24.9	1.1	0.4								
Lane LOS	B	C	A	A								
Approach Delay (s)	10.1	24.9	1.1	0.4								
Approach LOS	B	C										
Intersection Summary												
Average Delay			3.4									
Intersection Capacity Utilization			59.1%		ICU Level of Service					B		
Analysis Period (min)			15									

















HCM Unsignalized Intersection Capacity Analysis
 9005: Nixon Rd & Proposed South Dr./Haverhill Court

11/19/2014

												
Movement	EBL	EBT	EBR	WBL	WBT	WBR	NBL	NBT	NBR	SBL	SBT	SBR
Lane Configurations												
Volume (veh/h)	19	0	13	9	0	0	22	581	9	5	279	32
Sign Control		Stop			Stop			Free			Free	
Grade		0%			0%			0%			0%	
Peak Hour Factor	0.92	0.92	0.92	0.92	0.92	0.92	0.91	0.91	0.92	0.92	0.93	0.93
Hourly flow rate (vph)	21	0	14	10	0	0	24	638	10	5	300	34
Pedestrians												
Lane Width (ft)												
Walking Speed (ft/s)												
Percent Blockage												
Right turn flare (veh)												
Median type												
Median storage (veh)												
Upstream signal (ft)												
pX, platoon unblocked												
vC, conflicting volume	1020	1025	317	1034	1037	643	334			648		
vC1, stage 1 conf vol												
vC2, stage 2 conf vol												
vCu, unblocked vol	1020	1025	317	1034	1037	643	334			648		
tC, single (s)	7.1	6.5	6.2	7.1	6.5	6.2	4.1			4.1		
tC, 2 stage (s)												
tF (s)	3.5	4.0	3.3	3.5	4.0	3.3	2.2			2.2		
p0 queue free %	90	100	98	95	100	100	98			99		
cM capacity (veh/h)	211	229	723	202	225	473	1225			938		
Direction, Lane #												
	EB 1	WB 1	NB 1	SB 1								
Volume Total	35	10	672	340								
Volume Left	21	10	24	5								
Volume Right	14	0	10	34								
cSH	296	202	1225	938								
Volume to Capacity	0.12	0.05	0.02	0.01								
Queue Length 95th (ft)	10	4	2	0								
Control Delay (s)	18.8	23.7	0.5	0.2								
Lane LOS	C	C	A	A								
Approach Delay (s)	18.8	23.7	0.5	0.2								
Approach LOS	C	C										
Intersection Summary												
Average Delay			1.2									
Intersection Capacity Utilization			53.4%	ICU Level of Service		A						
Analysis Period (min)			15									





















HCM Unsignalized Intersection Capacity Analysis
 9006: Proposed Dr & Dhu Varren Rd

11/19/2014

												
Movement	EBL	EBT	EBR	WBL	WBT	WBR	NBL	NBT	NBR	SBL	SBT	SBR
Lane Configurations												
Volume (veh/h)	6	272	5	22	321	22	3	0	13	13	0	4
Sign Control		Free			Free			Stop			Stop	
Grade		0%			0%			0%			0%	
Peak Hour Factor	0.83	0.83	0.83	0.91	0.91	0.91	0.92	0.92	0.92	0.92	0.92	0.92
Hourly flow rate (vph)	7	328	6	24	353	24	3	0	14	14	0	4
Pedestrians												
Lane Width (ft)												
Walking Speed (ft/s)												
Percent Blockage												
Right turn flare (veh)												
Median type		None			None							
Median storage (veh)												
Upstream signal (ft)												
pX, platoon unblocked												
vC, conflicting volume	377			334			763	770	331	772	761	365
vC1, stage 1 conf vol												
vC2, stage 2 conf vol												
vCu, unblocked vol	377			334			763	770	331	772	761	365
tC, single (s)	4.1			4.1			7.1	6.5	6.2	7.1	6.5	6.2
tC, 2 stage (s)												
tF (s)	2.2			2.2			3.5	4.0	3.3	3.5	4.0	3.3
p0 queue free %	99			98			99	100	98	95	100	99
cM capacity (veh/h)	1182			1226			313	322	711	304	326	680
Direction, Lane #	EB 1	WB 1	NB 1	SB 1								
Volume Total	341	401	17	18								
Volume Left	7	24	3	14								
Volume Right	6	24	14	4								
cSH	1182	1226	574	349								
Volume to Capacity	0.01	0.02	0.03	0.05								
Queue Length 95th (ft)	0	2	2	4								
Control Delay (s)	0.2	0.7	11.5	15.9								
Lane LOS	A	A	B	C								
Approach Delay (s)	0.2	0.7	11.5	15.9								
Approach LOS			B	C								
Intersection Summary												
Average Delay			1.1									
Intersection Capacity Utilization			39.6%		ICU Level of Service				A			
Analysis Period (min)			15									

Lanes, Volumes, Timings
1001: Nixon Rd & Plymouth Rd

11/19/2014

												
Lane Group	EBL	EBT	EBR	WBL	WBT	WBR	NBL	NBT	NBR	SBL	SBT	SBR
Lane Configurations												
Volume (vph)	98	758	80	14	839	110	14	15	9	189	79	232
Ideal Flow (vphpl)	1900	1900	1900	1900	1900	1900	1900	1900	1900	1900	1900	1900
Storage Length (ft)	135		0	105		0	75		0	95		0
Storage Lanes	1		0	1		0	1		0	1		0
Taper Length (ft)	25			25			25			25		
Lane Util. Factor	1.00	0.95	0.95	1.00	0.95	0.95	1.00	1.00	1.00	1.00	1.00	1.00
Frt		0.986			0.983			0.945				0.888
Flt Protected	0.950			0.950			0.950			0.950		
Satd. Flow (prot)	1736	3423	0	1752	3445	0	1597	1589	0	1752	1638	0
Flt Permitted	0.171			0.272			0.339			0.488		
Satd. Flow (perm)	312	3423	0	502	3445	0	570	1589	0	900	1638	0
Right Turn on Red			Yes			Yes			Yes			Yes
Satd. Flow (RTOR)		11			14			12			128	
Link Speed (mph)		35			35			30			30	
Link Distance (ft)		859			966			284			994	
Travel Time (s)		16.7			18.8			6.5			22.6	
Peak Hour Factor	0.94	0.94	0.94	0.92	0.92	0.92	0.73	0.73	0.73	0.79	0.79	0.79
Heavy Vehicles (%)	4%	4%	4%	3%	3%	3%	13%	13%	13%	3%	3%	3%
Adj. Flow (vph)	104	806	85	15	912	120	19	21	12	239	100	294
Shared Lane Traffic (%)												
Lane Group Flow (vph)	104	891	0	15	1032	0	19	33	0	239	394	0
Turn Type	pm+pt	NA		pm+pt	NA		pm+pt	NA		pm+pt	NA	
Protected Phases	1	6		5	2		7	4		3	8	
Permitted Phases	6			2			4			8		
Detector Phase	1	6		5	2		7	4		3	8	
Switch Phase												
Minimum Initial (s)	4.0	10.0		8.0	10.0		4.0	7.0		4.0	10.0	
Minimum Split (s)	10.0	19.3		14.0	24.3		10.0	26.5		10.0	26.5	
Total Split (s)	15.0	53.0		14.0	52.0		10.0	32.0		21.0	43.0	
Total Split (%)	12.5%	44.2%		11.7%	43.3%		8.3%	26.7%		17.5%	35.8%	
Yellow Time (s)	3.5	3.6		3.5	3.6		3.5	3.5		3.5	3.5	
All-Red Time (s)	2.5	2.3		2.5	2.3		2.5	2.5		2.5	2.5	
Lost Time Adjust (s)	0.0	0.0		0.0	0.0		0.0	0.0		0.0	0.0	
Total Lost Time (s)	6.0	5.9		6.0	5.9		6.0	6.0		6.0	6.0	
Lead/Lag	Lead	Lag		Lead	Lag		Lead	Lag		Lead	Lag	
Lead-Lag Optimize?												
Recall Mode	None	C-Max		None	C-Max		None	None		None	None	
Act Effect Green (s)	75.5	71.8		71.3	63.4		14.6	13.4		30.7	26.7	
Actuated g/C Ratio	0.63	0.60		0.59	0.53		0.12	0.11		0.26	0.22	
v/c Ratio	0.36	0.43		0.04	0.56		0.18	0.18		0.69	0.85	
Control Delay	14.6	17.7		4.4	12.2		33.2	32.9		47.0	46.3	
Queue Delay	0.0	0.0		0.0	0.0		0.0	0.0		0.0	0.0	
Total Delay	14.6	17.7		4.4	12.2		33.2	32.9		47.0	46.3	
LOS	B	B		A	B		C	C		D	D	
Approach Delay		17.4			12.1			33.0			46.6	
Approach LOS		B			B			C			D	
Queue Length 50th (ft)	26	146		1	285		12	16		165	202	
Queue Length 95th (ft)	72	363		m2	412		20	32		168	233	

Lanes, Volumes, Timings
 1001: Nixon Rd & Plymouth Rd

11/19/2014

Lane Group	EBL	EBT	EBR	WBL	WBT	WBR	NBL	NBT	NBR	SBL	SBT	SBR
Internal Link Dist (ft)		779			886			204			914	
Turn Bay Length (ft)	135			105			75			95		
Base Capacity (vph)	304	2052		381	1827		103	353		347	593	
Starvation Cap Reductn	0	0		0	0		0	0		0	0	
Spillback Cap Reductn	0	0		0	0		0	0		0	0	
Storage Cap Reductn	0	0		0	0		0	0		0	0	
Reduced v/c Ratio	0.34	0.43		0.04	0.56		0.18	0.09		0.69	0.66	

Intersection Summary





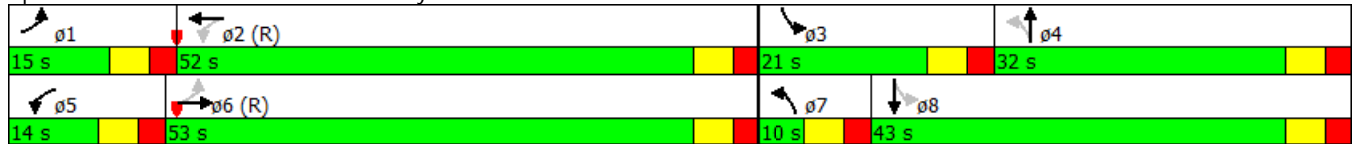





















Area Type: Other
 Cycle Length: 120
 Actuated Cycle Length: 120
 Offset: 42 (35%), Referenced to phase 2:WBTL and 6:EBTL, Start of Green
 Natural Cycle: 80
 Control Type: Actuated-Coordinated
 Maximum v/c Ratio: 0.85
 Intersection Signal Delay: 22.4 Intersection LOS: C
 Intersection Capacity Utilization 65.5% ICU Level of Service C
 Analysis Period (min) 15
 m Volume for 95th percentile queue is metered by upstream signal.

Splits and Phases: 1001: Nixon Rd & Plymouth Rd



Lanes, Volumes, Timings
 1002: Huron Pkwy & Plymouth Rd

11/19/2014

												
Lane Group	EBL	EBT	EBR	WBL	WBT	WBR	NBL	NBT	NBR	SBL	SBT	SBR
Lane Configurations		 			 			 			 	
Volume (vph)	2	761	192	37	866	150	90	199	158	242	262	7
Ideal Flow (vphpl)	1900	1900	1900	1900	1900	1900	1900	1900	1900	1900	1900	1900
Storage Length (ft)	120		0	195		0	410		450	120		0
Storage Lanes	1		0	1		0	1		1	1		0
Taper Length (ft)	25			25			25			25		
Lane Util. Factor	1.00	0.95	0.95	1.00	0.95	0.95	1.00	0.95	1.00	1.00	0.95	0.95
Frt		0.970			0.978				0.850		0.996	
Flt Protected	0.950			0.950			0.950			0.950		
Satd. Flow (prot)	1770	3433	0	1770	3461	0	1770	3539	1583	1770	3525	0
Flt Permitted	0.176			0.168			0.558			0.418		
Satd. Flow (perm)	328	3433	0	313	3461	0	1039	3539	1583	779	3525	0
Right Turn on Red			Yes			Yes			Yes			Yes
Satd. Flow (RTOR)		24			19				88			2
Link Speed (mph)		35			35			35			35	
Link Distance (ft)		966			889			979			397	
Travel Time (s)		18.8			17.3			19.1			7.7	
Peak Hour Factor	0.93	0.93	0.93	0.86	0.86	0.86	0.98	0.98	0.98	0.84	0.84	0.84
Adj. Flow (vph)	2	818	206	43	1007	174	92	203	161	288	312	8
Shared Lane Traffic (%)												
Lane Group Flow (vph)	2	1024	0	43	1181	0	92	203	161	288	320	0
Turn Type	pm+pt	NA		pm+pt	NA		pm+pt	NA	pm+ov	pm+pt	NA	
Protected Phases	1	6		5	2		7	4	5	3	8	
Permitted Phases	6			2			4		4	8		
Detector Phase	1	6		5	2		7	4	5	3	8	
Switch Phase												
Minimum Initial (s)	4.0	20.0		4.0	10.0		4.0	10.0	4.0	4.0	10.0	
Minimum Split (s)	16.0	34.0		34.0	52.0		23.0	30.0	34.0	22.0	29.0	
Total Split (s)	16.0	34.0		34.0	52.0		23.0	30.0	34.0	22.0	29.0	
Total Split (%)	13.3%	28.3%		28.3%	43.3%		19.2%	25.0%	28.3%	18.3%	24.2%	
Yellow Time (s)	3.6	3.6		4.3	4.3		3.9	3.9	4.3	3.6	3.6	
All-Red Time (s)	2.3	2.5		2.5	2.3		2.5	2.0	2.5	2.5	2.3	
Lost Time Adjust (s)	0.0	0.0		0.0	0.0		0.0	0.0	0.0	0.0	0.0	
Total Lost Time (s)	5.9	6.1		6.8	6.6		6.4	5.9	6.8	6.1	5.9	
Lead/Lag	Lead	Lag		Lead	Lag		Lead	Lag	Lead	Lead	Lag	
Lead-Lag Optimize?												
Recall Mode	None	C-Max		None	C-Max		None	None	None	None	None	
Act Effect Green (s)	65.4	59.6		71.8	70.3		22.7	13.0	25.7	33.2	18.3	
Actuated g/C Ratio	0.54	0.50		0.60	0.59		0.19	0.11	0.21	0.28	0.15	
v/c Ratio	0.01	0.60		0.16	0.58		0.36	0.53	0.40	0.83	0.60	
Control Delay	21.0	27.3		12.0	18.1		35.9	55.2	20.8	58.0	52.1	
Queue Delay	0.0	0.0		0.0	0.0		0.0	0.0	0.0	0.0	0.0	
Total Delay	21.0	27.3		12.0	18.1		35.9	55.2	20.8	58.0	52.1	
LOS	C	C		B	B		D	E	C	E	D	
Approach Delay		27.3			17.8			39.1			54.9	
Approach LOS		C			B			D			D	
Queue Length 50th (ft)	1	211		13	262		54	80	47	191	123	
Queue Length 95th (ft)	m3	392		30	428		91	113	103	#245	155	
Internal Link Dist (ft)		886			809			899			317	

Lanes, Volumes, Timings
 1002: Huron Pkwy & Plymouth Rd

11/19/2014

Lane Group	EBL	EBT	EBR	WBL	WBT	WBR	NBL	NBT	NBR	SBL	SBT	SBR
Turn Bay Length (ft)	120			195			410		450	120		
Base Capacity (vph)	312	1717		519	2036		353	710	662	347	680	
Starvation Cap Reductn	0	0		0	0		0	0	0	0	0	
Spillback Cap Reductn	0	0		0	0		0	0	0	0	0	
Storage Cap Reductn	0	0		0	0		0	0	0	0	0	
Reduced v/c Ratio	0.01	0.60		0.08	0.58		0.26	0.29	0.24	0.83	0.47	

Intersection Summary

Area Type: Other
 Cycle Length: 120
 Actuated Cycle Length: 120
 Offset: 40 (33%), Referenced to phase 2:WBTL and 6:EBTL, Start of Green
 Natural Cycle: 120
 Control Type: Actuated-Coordinated
 Maximum v/c Ratio: 0.83
 Intersection Signal Delay: 30.5 Intersection LOS: C
 Intersection Capacity Utilization 67.8% ICU Level of Service C
 Analysis Period (min) 15
 # 95th percentile volume exceeds capacity, queue may be longer.
 Queue shown is maximum after two cycles.
 m Volume for 95th percentile queue is metered by upstream signal.

Splits and Phases: 1002: Huron Pkwy & Plymouth Rd

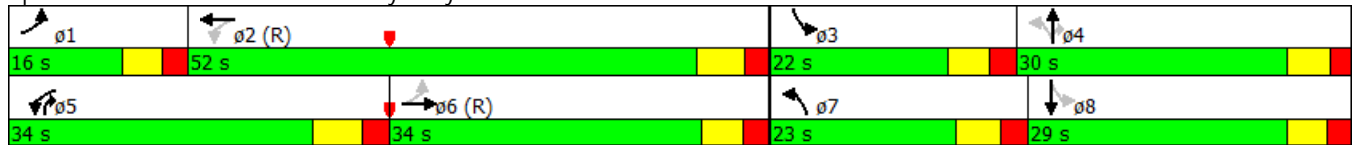

























Intersection												
Intersection Delay, s/veh	44.8											
Intersection LOS	E											
Movement	EBU	EBL	EBT	EBR	WBU	WBL	WBT	WBR	NBU	NBL	NBT	NBR
Vol, veh/h	0	2	1	15	0	109	1	29	0	2	332	58
Peak Hour Factor	0.92	0.85	0.85	0.85	0.92	0.56	0.56	0.56	0.92	0.76	0.76	0.76
Heavy Vehicles, %	2	0	0	0	2	1	1	1	2	2	2	2
Mvmt Flow	0	2	1	18	0	195	2	52	0	3	437	76
Number of Lanes	0	0	1	0	0	0	1	0	0	0	1	0

Approach	EB	WB	NB
Opposing Approach	WB	EB	SB
Opposing Lanes	1	1	2
Conflicting Approach Left	SB	NB	EB
Conflicting Lanes Left	2	1	1
Conflicting Approach Right	NB	SB	WB
Conflicting Lanes Right	1	2	1
HCM Control Delay	10.8	16.2	33.5
HCM LOS	B	C	D

Lane	NBLn1	EBLn1	WBLn1	SBLn1	SBLn2
Vol Left, %	1%	11%	78%	100%	0%
Vol Thru, %	85%	6%	1%	0%	100%
Vol Right, %	15%	83%	21%	0%	0%
Sign Control	Stop	Stop	Stop	Stop	Stop
Traffic Vol by Lane	392	18	139	40	684
LT Vol	332	1	1	0	684
Through Vol	58	15	29	0	0
RT Vol	2	2	109	40	0
Lane Flow Rate	516	21	248	50	855
Geometry Grp	5	2	2	7	7
Degree of Util (X)	0.849	0.044	0.479	0.095	1
Departure Headway (Hd)	5.929	7.431	6.94	6.854	6.345
Convergence, Y/N	Yes	Yes	Yes	Yes	Yes
Cap	614	481	521	523	573
Service Time	3.957	5.487	4.967	4.6	4.091
HCM Lane V/C Ratio	0.84	0.044	0.476	0.096	1.492
HCM Control Delay	33.5	10.8	16.2	10.3	62.7
HCM Lane LOS	D	B	C	B	F
HCM 95th-tile Q	9.3	0.1	2.6	0.3	14.5

Lanes, Volumes, Timings
1001: Nixon Rd & Plymouth Rd

11/19/2014

												
Lane Group	EBL	EBT	EBR	WBL	WBT	WBR	NBL	NBT	NBR	SBL	SBT	SBR
Lane Configurations		 			 			 			 	
Volume (vph)	249	783	35	13	893	106	93	64	41	261	19	199
Ideal Flow (vphpl)	1900	1900	1900	1900	1900	1900	1900	1900	1900	1900	1900	1900
Storage Length (ft)	135		0	105		0	75		0	95		0
Storage Lanes	1		0	1		0	1		0	1		0
Taper Length (ft)	25			25			25			25		
Lane Util. Factor	1.00	0.95	0.95	1.00	0.95	0.95	1.00	1.00	1.00	1.00	1.00	1.00
Frt		0.994			0.984			0.941			0.863	
Flt Protected	0.950			0.950			0.950			0.950		
Satd. Flow (prot)	1770	3518	0	1787	3517	0	1787	1770	0	1770	1608	0
Flt Permitted	0.117			0.314			0.349			0.398		
Satd. Flow (perm)	218	3518	0	591	3517	0	657	1770	0	741	1608	0
Right Turn on Red			Yes			Yes			Yes			Yes
Satd. Flow (RTOR)		5			12			24			219	
Link Speed (mph)		35			35			30			30	
Link Distance (ft)		859			966			284			994	
Travel Time (s)		16.7			18.8			6.5			22.6	
Peak Hour Factor	0.90	0.90	0.90	0.92	0.92	0.92	0.78	0.78	0.78	0.91	0.91	0.91
Heavy Vehicles (%)	2%	2%	2%	1%	1%	1%	1%	1%	1%	2%	2%	2%
Adj. Flow (vph)	277	870	39	14	971	115	119	82	53	287	21	219
Shared Lane Traffic (%)												
Lane Group Flow (vph)	277	909	0	14	1086	0	119	135	0	287	240	0
Turn Type	pm+pt	NA		pm+pt	NA		pm+pt	NA		pm+pt	NA	
Protected Phases	1	6		5	2		7	4		3	8	
Permitted Phases	6			2			4			8		
Detector Phase	1	6		5	2		7	4		3	8	
Switch Phase												
Minimum Initial (s)	4.0	10.0		8.0	10.0		4.0	7.0		4.0	10.0	
Minimum Split (s)	10.0	19.3		14.0	24.3		10.0	26.5		10.0	26.5	
Total Split (s)	26.0	60.0		14.0	48.0		15.0	27.0		19.0	31.0	
Total Split (%)	21.7%	50.0%		11.7%	40.0%		12.5%	22.5%		15.8%	25.8%	
Yellow Time (s)	3.5	3.6		3.5	3.6		3.5	3.5		3.5	3.5	
All-Red Time (s)	2.5	2.3		2.5	2.3		2.5	2.5		2.5	2.5	
Lost Time Adjust (s)	0.0	0.0		0.0	0.0		0.0	0.0		0.0	0.0	
Total Lost Time (s)	6.0	5.9		6.0	5.9		6.0	6.0		6.0	6.0	
Lead/Lag	Lead	Lag		Lead	Lag		Lead	Lag		Lead	Lag	
Lead-Lag Optimize?												
Recall Mode	None	C-Max		None	C-Max		None	None		None	None	
Act Effect Green (s)	76.1	70.6		59.4	51.5		21.6	12.9		30.2	17.2	
Actuated g/C Ratio	0.63	0.59		0.50	0.43		0.18	0.11		0.25	0.14	
v/c Ratio	0.73	0.44		0.04	0.72		0.60	0.64		0.97	0.58	
Control Delay	31.2	16.2		9.7	22.9		47.1	55.2		84.6	13.6	
Queue Delay	0.0	0.0		0.0	0.0		0.0	0.0		0.0	0.0	
Total Delay	31.2	16.2		9.7	22.9		47.1	55.2		84.6	13.6	
LOS	C	B		A	C		D	E		F	B	
Approach Delay		19.7			22.7			51.4			52.3	
Approach LOS		B			C			D			D	
Queue Length 50th (ft)	114	168		3	176		73	83		195	14	
Queue Length 95th (ft)	219	317		m7	#358		99	120		#259	88	

Lanes, Volumes, Timings
 1001: Nixon Rd & Plymouth Rd

11/19/2014

Lane Group	EBL	EBT	EBR	WBL	WBT	WBR	NBL	NBT	NBR	SBL	SBT	SBR
Internal Link Dist (ft)		779			886			204			914	
Turn Bay Length (ft)	135			105			75			95		
Base Capacity (vph)	410	2071		372	1515		204	329		297	508	
Starvation Cap Reductn	0	0		0	0		0	0		0	0	
Spillback Cap Reductn	0	0		0	0		0	0		0	0	
Storage Cap Reductn	0	0		0	0		0	0		0	0	
Reduced v/c Ratio	0.68	0.44		0.04	0.72		0.58	0.41		0.97	0.47	

Intersection Summary

Area Type: Other
 Cycle Length: 120
 Actuated Cycle Length: 120
 Offset: 42 (35%), Referenced to phase 2:WBTL and 6:EBTL, Start of Green
 Natural Cycle: 90
 Control Type: Actuated-Coordinated
 Maximum v/c Ratio: 0.97
 Intersection Signal Delay: 29.0 Intersection LOS: C
 Intersection Capacity Utilization 82.1% ICU Level of Service E
 Analysis Period (min) 15
 # 95th percentile volume exceeds capacity, queue may be longer.
 Queue shown is maximum after two cycles.
 m Volume for 95th percentile queue is metered by upstream signal.

Splits and Phases: 1001: Nixon Rd & Plymouth Rd

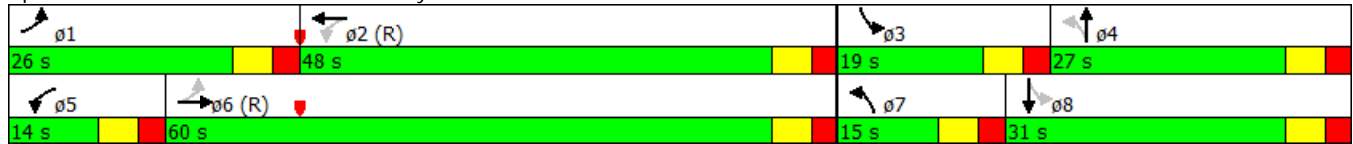

Lanes, Volumes, Timings
1002: Huron Pkwy & Plymouth Rd

11/19/2014

Lane Group	EBL	EBT	EBR	WBL	WBT	WBR	NBL	NBT	NBR	SBL	SBT	SBR
Lane Configurations												
Volume (vph)	20	892	172	113	738	157	249	325	312	236	177	26
Ideal Flow (vphpl)	1900	1900	1900	1900	1900	1900	1900	1900	1900	1900	1900	1900
Storage Length (ft)	120		0	195		0	410		450	120		0
Storage Lanes	1		0	1		0	1		1	1		0
Taper Length (ft)	25			25			25			25		
Lane Util. Factor	1.00	0.95	0.95	1.00	0.95	0.95	1.00	0.95	1.00	1.00	0.95	0.95
Frt		0.976			0.974				0.850		0.981	
Flt Protected	0.950			0.950			0.950			0.950		
Satd. Flow (prot)	1770	3454	0	1770	3447	0	1770	3539	1583	1770	3472	0
Flt Permitted	0.204			0.098			0.548			0.364		
Satd. Flow (perm)	380	3454	0	183	3447	0	1021	3539	1583	678	3472	0
Right Turn on Red			Yes			Yes			Yes			Yes
Satd. Flow (RTOR)		21			26				91			12
Link Speed (mph)		35			35			35				35
Link Distance (ft)		966			889			979				397
Travel Time (s)		18.8			17.3			19.1				7.7
Peak Hour Factor	0.93	0.93	0.93	0.86	0.86	0.86	0.98	0.98	0.98	0.84	0.84	0.84
Adj. Flow (vph)	22	959	185	131	858	183	254	332	318	281	211	31
Shared Lane Traffic (%)												
Lane Group Flow (vph)	22	1144	0	131	1041	0	254	332	318	281	242	0
Turn Type	pm+pt	NA		pm+pt	NA		pm+pt	NA	pm+ov	pm+pt	NA	
Protected Phases	1	6		5	2		7	4	5	3	8	
Permitted Phases	6			2			4		4	8		
Detector Phase	1	6		5	2		7	4	5	3	8	
Switch Phase												
Minimum Initial (s)	4.0	20.0		4.0	10.0		4.0	10.0	4.0	4.0	10.0	
Minimum Split (s)	9.9	27.5		10.8	27.3		10.4	26.0	10.8	10.1	25.3	
Total Split (s)	12.0	51.0		19.0	58.0		24.0	26.0	19.0	24.0	26.0	
Total Split (%)	10.0%	42.5%		15.8%	48.3%		20.0%	21.7%	15.8%	20.0%	21.7%	
Yellow Time (s)	3.6	3.6		4.3	4.3		3.9	3.9	4.3	3.6	3.6	
All-Red Time (s)	2.3	2.5		2.5	2.3		2.5	2.0	2.5	2.5	2.3	
Lost Time Adjust (s)	0.0	0.0		0.0	0.0		0.0	0.0	0.0	0.0	0.0	
Total Lost Time (s)	5.9	6.1		6.8	6.6		6.4	5.9	6.8	6.1	5.9	
Lead/Lag	Lead	Lag		Lead	Lag		Lead	Lag	Lead	Lead	Lag	
Lead-Lag Optimize?												
Recall Mode	None	C-Max		None	C-Max		None	None	None	None	None	
Act Effect Green (s)	57.8	51.7		67.1	60.5		32.3	16.4	32.1	33.9	16.9	
Actuated g/C Ratio	0.48	0.43		0.56	0.50		0.27	0.14	0.27	0.28	0.14	
v/c Ratio	0.09	0.76		0.56	0.59		0.67	0.69	0.65	0.81	0.49	
Control Delay	10.4	28.0		24.6	24.0		41.1	56.9	33.2	50.8	48.2	
Queue Delay	0.0	0.0		0.0	0.0		0.0	0.0	0.0	0.0	0.0	
Total Delay	10.4	28.0		24.6	24.0		41.1	56.9	33.2	50.8	48.2	
LOS	B	C		C	C		D	E	C	D	D	
Approach Delay		27.7			24.0			44.1			49.6	
Approach LOS		C			C			D			D	
Queue Length 50th (ft)	6	374		46	312		153	130	157	171	87	
Queue Length 95th (ft)	m12	m213		87	382		220	175	241	222	116	
Internal Link Dist (ft)		886			809			899			317	

Lanes, Volumes, Timings
 1002: Huron Pkwy & Plymouth Rd

11/19/2014

Lane Group	EBL	EBT	EBR	WBL	WBT	WBR	NBL	NBT	NBR	SBL	SBT	SBR
Turn Bay Length (ft)	120			195			410		450	120		
Base Capacity (vph)	255	1498		264	1751		394	592	519	358	591	
Starvation Cap Reductn	0	0		0	0		0	0	0	0	0	
Spillback Cap Reductn	0	0		0	0		0	0	0	0	0	
Storage Cap Reductn	0	0		0	0		0	0	0	0	0	
Reduced v/c Ratio	0.09	0.76		0.50	0.59		0.64	0.56	0.61	0.78	0.41	

Intersection Summary

Area Type: Other
 Cycle Length: 120
 Actuated Cycle Length: 120
 Offset: 40 (33%), Referenced to phase 2:WBTL and 6:EBTL, Start of Green
 Natural Cycle: 90
 Control Type: Actuated-Coordinated
 Maximum v/c Ratio: 0.81
 Intersection Signal Delay: 33.5 Intersection LOS: C
 Intersection Capacity Utilization 79.5% ICU Level of Service D
 Analysis Period (min) 15
 m Volume for 95th percentile queue is metered by upstream signal.

Splits and Phases: 1002: Huron Pkwy & Plymouth Rd

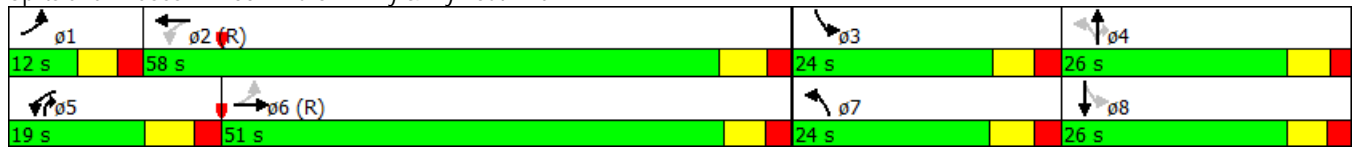

Intersection

Intersection Delay, s/veh	39.4
Intersection LOS	E

























Movement	EBU	EBL	EBT	EBR	WBU	WBL	WBT	WBR	NBU	NBL	NBT	NBR
Vol, veh/h	0	1	1	13	0	50	0	18	0	18	709	63
Peak Hour Factor	0.92	0.58	0.58	0.58	0.92	0.77	0.77	0.77	0.92	0.97	0.97	0.97
Heavy Vehicles, %	2	0	0	0	2	2	2	2	2	1	1	1
Mvmt Flow	0	2	2	22	0	65	0	23	0	19	731	65
Number of Lanes	0	0	1	0	0	0	1	0	0	0	1	0

Approach	EB	WB	NB
Opposing Approach	WB	EB	SB
Opposing Lanes	1	1	2
Conflicting Approach Left	SB	NB	EB
Conflicting Lanes Left	2	1	1
Conflicting Approach Right	NB	SB	WB
Conflicting Lanes Right	1	2	1
HCM Control Delay	9.7	11	55.4
HCM LOS	A	B	F

Lane	NBLn1	EBLn1	WBLn1	SBLn1	SBLn2
Vol Left, %	2%	7%	74%	100%	0%
Vol Thru, %	90%	7%	0%	0%	100%
Vol Right, %	8%	87%	26%	0%	0%
Sign Control	Stop	Stop	Stop	Stop	Stop
Traffic Vol by Lane	790	15	68	18	374
LT Vol	709	1	0	0	373
Through Vol	63	13	18	0	1
RT Vol	18	1	50	18	0
Lane Flow Rate	814	26	88	21	430
Geometry Grp	5	2	2	7	7
Degree of Util (X)	1	0.046	0.163	0.034	0.655
Departure Headway (Hd)	4.906	6.344	6.649	5.99	5.489
Convergence, Y/N	Yes	Yes	Yes	Yes	Yes
Cap	733	560	538	595	653
Service Time	2.995	4.434	4.712	3.752	3.251
HCM Lane V/C Ratio	1.111	0.046	0.164	0.035	0.658
HCM Control Delay	55.4	9.7	11	9	18.2
HCM Lane LOS	F	A	B	A	C
HCM 95th-tile Q	16.4	0.1	0.6	0.1	4.9

HCM Unsignalized Intersection Capacity Analysis
 9003: Nixon Rd & Dhu Varren/Green Road

9/9/2014

												
Movement	EBL	EBT	EBR	WBL	WBT	WBR	NBL	NBT	NBR	SBL	SBT	SBR
Lane Configurations												
Volume (veh/h)	22	176	250	135	65	41	111	103	81	148	340	30
Sign Control		Stop			Stop			Free			Free	
Grade		0%			0%			0%			0%	
Peak Hour Factor	0.95	0.95	0.95	0.74	0.74	0.74	0.63	0.63	0.63	0.89	0.89	0.89
Hourly flow rate (vph)	23	185	263	182	88	55	176	163	129	166	382	34
Pedestrians												
Lane Width (ft)												
Walking Speed (ft/s)												
Percent Blockage												
Right turn flare (veh)			6			7						
Median type								None			None	
Median storage (veh)												
Upstream signal (ft)												
pX, platoon unblocked												
vC, conflicting volume	1319	1376	399	1455	1264	163	416			292		
vC1, stage 1 conf vol												
vC2, stage 2 conf vol												
vCu, unblocked vol	1319	1376	399	1455	1264	163	416			292		
tC, single (s)	7.1	6.5	6.2	7.1	6.5	6.2	4.2			4.1		
tC, 2 stage (s)												
tF (s)	3.5	4.0	3.3	3.5	4.0	3.3	2.3			2.2		
p0 queue free %	46	0	59	0	29	94	84			87		
cM capacity (veh/h)	43	106	649	0	123	876	1122			1270		
Direction, Lane #	EB 1	EB 2	WB 1	WB 2	NB 1	NB 2	NB 3	SB 1	SB 2			
Volume Total	23	448	182	143	176	163	129	166	416			
Volume Left	23	0	182	0	176	0	0	166	0			
Volume Right	0	263	0	55	0	0	129	0	34			
cSH	43	220	0	201	1122	1700	1700	1270	1700			
Volume to Capacity	0.54	2.04	Err	0.71	0.16	0.10	0.08	0.13	0.24			
Queue Length 95th (ft)	49	839	Err	114	14	0	0	11	0			
Control Delay (s)	160.3	519.0	Err	56.6	8.8	0.0	0.0	8.3	0.0			
Lane LOS	F	F	F	F	A			A				
Approach Delay (s)	501.4		Err		3.3			2.4				
Approach LOS	F		F									
Intersection Summary												
Average Delay			Err									
Intersection Capacity Utilization			55.9%		ICU Level of Service				B			
Analysis Period (min)			15									

Intersection

Intersection Delay, s/veh 34.7
Intersection LOS D

Movement	EBU	EBL	EBT	EBR	WBU	WBL	WBT	WBR	NBU	NBL	NBT	NBR
Vol, veh/h	0	22	176	250	0	135	65	41	0	111	103	81
Peak Hour Factor	0.92	0.95	0.95	0.95	0.92	0.74	0.74	0.74	0.92	0.63	0.63	0.63
Heavy Vehicles, %	2	3	3	3	2	4	4	4	2	6	6	6
Mvmt Flow	0	23	185	263	0	182	88	55	0	176	163	129
Number of Lanes	0	1	1	1	0	1	1	1	0	1	1	1

Approach	EB	WB	NB
Opposing Approach	WB	EB	SB
Opposing Lanes	3	3	2
Conflicting Approach Left	SB	NB	EB
Conflicting Lanes Left	2	3	3
Conflicting Approach Right	NB	SB	WB
Conflicting Lanes Right	3	2	3
HCM Control Delay	25.6	21.4	20.6
HCM LOS	D	C	C

Lane	NBLn1	NBLn2	NBLn3	EBLn1	EBLn2	EBLn3	WBLn1	WBLn2	WBLn3	SBLn1	SBLn2
Vol Left, %	100%	0%	0%	100%	0%	0%	100%	0%	0%	100%	0%
Vol Thru, %	0%	100%	0%	0%	100%	0%	0%	100%	0%	0%	92%
Vol Right, %	0%	0%	100%	0%	0%	100%	0%	0%	100%	0%	8%
Sign Control	Stop	Stop	Stop	Stop	Stop	Stop	Stop	Stop	Stop	Stop	Stop
Traffic Vol by Lane	111	103	81	22	176	250	135	65	41	148	370
LT Vol	0	103	0	0	176	0	0	65	0	0	340
Through Vol	0	0	81	0	0	250	0	0	41	0	30
RT Vol	111	0	0	22	0	0	135	0	0	148	0
Lane Flow Rate	176	163	129	23	185	263	182	88	55	166	416
Geometry Grp	8	8	8	8	8	8	8	8	8	8	8
Degree of Util (X)	0.508	0.449	0.329	0.067	0.507	0.67	0.55	0.253	0.149	0.458	1
Departure Headway (Hd)	10.496	10.002	9.312	10.462	9.971	9.283	10.847	10.356	9.67	9.921	9.364
Convergence, Y/N	Yes	Yes	Yes	Yes	Yes	Yes	Yes	Yes	Yes	Yes	Yes
Cap	345	363	388	344	363	392	334	349	373	364	391
Service Time	8.196	7.702	7.012	8.162	7.671	6.983	8.551	8.061	7.374	7.635	7.078
HCM Lane V/C Ratio	0.51	0.449	0.332	0.067	0.51	0.671	0.545	0.252	0.147	0.456	1.064
HCM Control Delay	23.5	20.6	16.5	13.9	22.5	28.9	26	16.5	14.1	20.8	77
HCM Lane LOS	C	C	C	B	C	D	D	C	B	C	F
HCM 95th-tile Q	2.7	2.2	1.4	0.2	2.7	4.7	3.1	1	0.5	2.3	12

Intersection

Intersection Delay, s/veh
 Intersection LOS

Movement	SBU	SBL	SBT	SBR
Vol, veh/h	0	148	340	30
Peak Hour Factor	0.92	0.89	0.89	0.89
Heavy Vehicles, %	2	2	2	2
Mvmt Flow	0	166	382	34
Number of Lanes	0	1	1	0

Approach	SB
Opposing Approach	NB
Opposing Lanes	3
Conflicting Approach Left	WB
Conflicting Lanes Left	3
Conflicting Approach Right	EB
Conflicting Lanes Right	3
HCM Control Delay	60.9
HCM LOS	F

Lane

HCM 2010 Roundabout
 9003: Nixon Rd & Dhu Varren/Green Road

9/9/2014

Intersection

Intersection Delay, s/veh 28.0
 Intersection LOS D

Approach	EB	WB	NB	SB
Entry Lanes	1	1	1	1
Conflicting Circle Lanes	1	1	1	1
Adj Approach Flow, veh/h	471	325	468	582
Demand Flow Rate, veh/h	486	338	497	594
Vehicles Circulating, veh/h	748	384	384	468
Vehicles Exiting, veh/h	314	497	850	254
Follow-Up Headway, s	3.186	3.186	3.186	3.186
Ped Vol Crossing Leg, #/h	0	0	0	0
Ped Cap Adj	1.000	1.000	1.000	1.000
Approach Delay, s/veh	48.0	10.8	16.8	30.4
Approach LOS	E	B	C	D

Lane	Left	Left	Left	Left
Designated Moves	LTR	LTR	LTR	LTR
Assumed Moves	LTR	LTR	LTR	LTR
RT Channelized				
Lane Util	1.000	1.000	1.000	1.000
Critical Headway, s	5.193	5.193	5.193	5.193
Entry Flow, veh/h	486	338	497	594
Cap Entry Lane, veh/h	535	770	770	708
Entry HV Adj Factor	0.970	0.963	0.942	0.980
Flow Entry, veh/h	471	325	468	582
Cap Entry, veh/h	519	741	725	694
V/C Ratio	0.909	0.439	0.646	0.839
Control Delay, s/veh	48.0	10.8	16.8	30.4
LOS	E	B	C	D
95th %tile Queue, veh	11	2	5	9

HCM 2010 Roundabout
 9003: Nixon Rd & Dhu Varren/Green Road

9/9/2014

Intersection

Intersection Delay, s/veh 15.8
 Intersection LOS C

Approach	EB	WB	NB	SB
Entry Lanes	2	2	2	2
Conflicting Circle Lanes	1	1	1	1
Adj Approach Flow, veh/h	471	325	468	582
Demand Flow Rate, veh/h	486	338	497	594
Vehicles Circulating, veh/h	748	384	384	468
Vehicles Exiting, veh/h	314	497	850	254
Follow-Up Headway, s	3.186	3.186	3.186	3.186
Ped Vol Crossing Leg, #/h	0	0	0	0
Ped Cap Adj	1.000	1.000	1.000	1.000
Approach Delay, s/veh	15.1	8.8	10.3	24.6
Approach LOS	C	A	B	C

Lane	Left		Right		Left		Right		Left		Right	
Designated Moves	LT	R	LT	R	LT	R	LT	R	LT	R	LT	R
Assumed Moves	LT	R	LT	R	LT	R	LT	R	LT	R	LT	R
RT Channelized												
Lane Util	0.442	0.558	0.831	0.169	0.724	0.276	0.941	0.059				
Critical Headway, s	5.193	5.193	5.193	5.193	5.193	5.193	5.193	5.193				
Entry Flow, veh/h	215	271	281	57	360	137	559	35				
Cap Entry Lane, veh/h	535	535	770	770	770	770	708	708				
Entry HV Adj Factor	0.969	0.970	0.962	0.965	0.942	0.942	0.981	0.971				
Flow Entry, veh/h	208	263	270	55	339	129	548	34				
Cap Entry, veh/h	518	519	741	743	725	725	694	687				
V/C Ratio	0.402	0.507	0.365	0.074	0.468	0.178	0.790	0.049				
Control Delay, s/veh	13.5	16.4	9.5	5.6	11.6	6.9	25.7	5.8				
LOS	B	C	A	A	B	A	D	A				
95th %tile Queue, veh	2	3	2	0	3	1	8	0				

Lanes, Volumes, Timings
 9003: Nixon Rd & Dhu Varren/Green Road

9/9/2014

Lane Group	EBL	EBT	EBR	WBL	WBT	WBR	NBL	NBT	NBR	SBL	SBT	SBR
Lane Configurations												
Volume (vph)	22	176	250	135	65	41	111	103	81	148	340	30
Ideal Flow (vphpl)	1900	1900	1900	1900	1900	1900	1900	1900	1900	1900	1900	1900
Storage Length (ft)	150		150	180		180	150		0	150		0
Storage Lanes	1		1	1		1	1		1	1		0
Taper Length (ft)	25			25			25			25		
Lane Util. Factor	1.00	1.00	1.00	1.00	1.00	1.00	1.00	1.00	1.00	1.00	1.00	1.00
Frts			0.850			0.850			0.850		0.988	
Fit Protected	0.950			0.950			0.950			0.950		
Satd. Flow (prot)	1752	1845	1568	1736	1827	1553	1703	1792	1524	1770	1840	0
Fit Permitted	0.700			0.572			0.325			0.654		
Satd. Flow (perm)	1291	1845	1568	1045	1827	1553	583	1792	1524	1218	1840	0
Right Turn on Red			Yes			Yes			Yes			Yes
Satd. Flow (RTOR)			263			182			182		7	
Link Speed (mph)		30			25			30			35	
Link Distance (ft)		1081			887			610			700	
Travel Time (s)		24.6			24.2			13.9			13.6	
Peak Hour Factor	0.95	0.95	0.95	0.74	0.74	0.74	0.63	0.63	0.63	0.89	0.89	0.89
Heavy Vehicles (%)	3%	3%	3%	4%	4%	4%	6%	6%	6%	2%	2%	2%
Adj. Flow (vph)	23	185	263	182	88	55	176	163	129	166	382	34
Shared Lane Traffic (%)												
Lane Group Flow (vph)	23	185	263	182	88	55	176	163	129	166	416	0
Turn Type	pm+pt	NA	Perm	pm+pt	NA	Perm	pm+pt	NA	Perm	pm+pt	NA	
Protected Phases	7	4		3	8		5	2		1	6	
Permitted Phases	4		4	8		8	2		2	6		
Detector Phase	7	4	4	3	8	8	5	2	2	1	6	
Switch Phase												
Minimum Initial (s)	4.0	4.0	4.0	4.0	4.0	4.0	4.0	4.0	4.0	4.0	4.0	
Minimum Split (s)	9.0	21.0	21.0	9.0	21.0	21.0	9.0	21.0	21.0	9.0	21.0	
Total Split (s)	11.0	21.0	21.0	11.0	21.0	21.0	11.0	29.0	29.0	11.0	29.0	
Total Split (%)	15.3%	29.2%	29.2%	15.3%	29.2%	29.2%	15.3%	40.3%	40.3%	15.3%	40.3%	
Yellow Time (s)	3.5	3.5	3.5	3.5	3.5	3.5	3.5	3.5	3.5	3.5	3.5	
All-Red Time (s)	1.5	1.5	1.5	1.5	1.5	1.5	1.5	1.5	1.5	1.5	1.5	
Lost Time Adjust (s)	0.0	0.0	0.0	0.0	0.0	0.0	0.0	0.0	0.0	0.0	0.0	
Total Lost Time (s)	5.0	5.0	5.0	5.0	5.0	5.0	5.0	5.0	5.0	5.0	5.0	
Lead/Lag	Lag	Lead	Lead	Lag	Lead	Lead	Lag	Lead	Lead	Lag	Lead	
Lead-Lag Optimize?												
Recall Mode	None	None	None	None	None	None	Max	C-Max	C-Max	Max	C-Max	
Act Effct Green (s)	18.9	12.4	12.4	19.4	16.9	16.9	33.8	27.8	27.8	33.8	27.8	
Actuated g/C Ratio	0.26	0.17	0.17	0.27	0.23	0.23	0.47	0.39	0.39	0.47	0.39	
v/c Ratio	0.06	0.59	0.54	0.54	0.21	0.11	0.48	0.24	0.18	0.27	0.58	
Control Delay	16.1	34.6	8.1	27.2	25.8	0.4	18.9	17.4	1.9	11.6	22.4	
Queue Delay	0.0	0.0	0.0	0.0	0.0	0.0	0.0	0.0	0.0	0.0	0.0	
Total Delay	16.1	34.6	8.1	27.2	25.8	0.4	18.9	17.4	1.9	11.6	22.4	
LOS	B	C	A	C	C	A	B	B	A	B	C	
Approach Delay		18.9			22.3			13.7			19.3	
Approach LOS		B			C			B			B	
Queue Length 50th (ft)	8	77	0	61	28	0	37	47	0	34	139	
Queue Length 95th (ft)	20	129	55	80	60	0	51	65	0	72	244	

Lanes, Volumes, Timings
 9003: Nixon Rd & Dhu Varren/Green Road

9/9/2014

Lane Group	EBL	EBT	EBR	WBL	WBT	WBR	NBL	NBT	NBR	SBL	SBT	SBR
Internal Link Dist (ft)		1001			807			530			620	
Turn Bay Length (ft)	150		150	180		180	150			150		
Base Capacity (vph)	394	410	553	345	478	540	366	690	699	617	713	
Starvation Cap Reductn	0	0	0	0	0	0	0	0	0	0	0	
Spillback Cap Reductn	0	0	0	0	0	0	0	0	0	0	0	
Storage Cap Reductn	0	0	0	0	0	0	0	0	0	0	0	
Reduced v/c Ratio	0.06	0.45	0.48	0.53	0.18	0.10	0.48	0.24	0.18	0.27	0.58	

Intersection Summary

Area Type: Other
 Cycle Length: 72
 Actuated Cycle Length: 72
 Offset: 0 (0%), Referenced to phase 2:NBTL and 6:SBTL, Start of Green
 Natural Cycle: 60
 Control Type: Actuated-Coordinated
 Maximum v/c Ratio: 0.59
 Intersection Signal Delay: 18.3
 Intersection Capacity Utilization 59.3%
 Analysis Period (min) 15





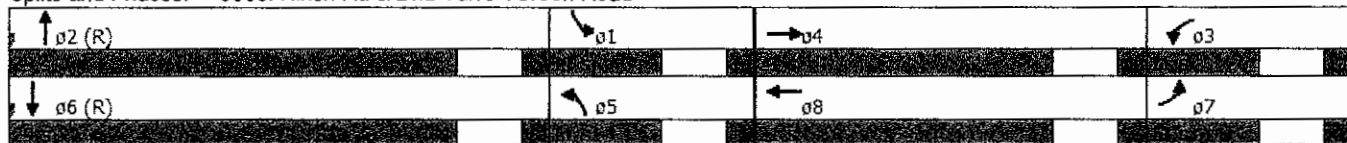



















Intersection LOS: B
 ICU Level of Service B

Splits and Phases: 9003: Nixon Rd & Dhu Varren/Green Road



HCM Unsignalized Intersection Capacity Analysis
 9003: Nixon Rd & Dhu Varren Rd/Green Road

9/9/2014

												
Movement	EBL	EBT	EBR	WBL	WBT	WBR	NBL	NBT	NBR	SBL	SBT	SBR
Lane Configurations												
Volume (veh/h)	35	133	130	67	180	208	156	346	98	61	119	29
Sign Control		Stop			Stop			Free			Free	
Grade		0%			0%			0%			0%	
Peak Hour Factor	0.83	0.83	0.83	0.91	0.91	0.91	0.91	0.91	0.91	0.93	0.93	0.93
Hourly flow rate (vph)	42	160	157	74	198	229	171	380	108	66	128	31
Pedestrians												
Lane Width (ft)												
Walking Speed (ft/s)												
Percent Blockage												
Right turn flare (veh)			6			7						
Median type								None			None	
Median storage (veh)												
Upstream signal (ft)												
pX, platoon unblocked												
vC, conflicting volume	1211	1106	144	1141	1013	380	159			488		
vC1, stage 1 conf vol												
vC2, stage 2 conf vol												
vCu, unblocked vol	1211	1106	144	1141	1013	380	159			488		
tC, single (s)	7.1	6.5	6.2	7.1	6.5	6.2	4.1			4.1		
tC, 2 stage (s)												
tF (s)	3.5	4.0	3.3	3.5	4.0	3.3	2.2			2.2		
p0 queue free %	0	8	83	0	0	66	88			94		
cM capacity (veh/h)	1	174	904	26	198	669	1420			1075		
Direction, Lane #	EB 1	EB 2	WB 1	WB 2	NB 1	NB 2	NB 3	SB 1	SB 2			
Volume Total	42	317	74	426	171	380	108	66	159			
Volume Left	42	0	74	0	171	0	0	66	0			
Volume Right	0	157	0	229	0	0	108	0	31			
cSH	1	344	26	427	1420	1700	1700	1075	1700			
Volume to Capacity	33.05	0.92	2.87	1.00	0.12	0.22	0.06	0.06	0.09			
Queue Length 95th (ft)	Err	234	226	316	10	0	0	5	0			
Control Delay (s)	Err	56.6	1164.3	59.7	7.9	0.0	0.0	8.6	0.0			
Lane LOS	F	F	F	F	A			A				
Approach Delay (s)	1224.3		222.4		2.0			2.5				
Approach LOS	F		F									
Intersection Summary												
Average Delay			317.1									
Intersection Capacity Utilization			47.7%		ICU Level of Service				A			
Analysis Period (min)			15									

HCM 2010 AWSC
9003: Nixon Rd & Dhu Varren Rd/Green Road

9/9/2014

Intersection

Intersection Delay, s/veh 27.1
Intersection LOS D

Movement	EBU	EBL	EBT	EBR	WBU	WBL	WBT	WBR	NBU	NBL	NBT	NBR
Vol, veh/h	0	35	133	130	0	67	180	208	0	156	346	98
Peak Hour Factor	0.92	0.83	0.83	0.83	0.92	0.91	0.91	0.91	0.92	0.91	0.91	0.91
Heavy Vehicles, %	2	2	2	2	2	1	1	1	2	2	2	2
Mvmt Flow	0	42	160	157	0	74	198	229	0	171	380	108
Number of Lanes	0	1	1	1	0	1	1	1	0	1	1	1

Approach	EB	WB	NB
Opposing Approach	WB	EB	SB
Opposing Lanes	3	3	2
Conflicting Approach Left	SB	NB	EB
Conflicting Lanes Left	2	3	3
Conflicting Approach Right	NB	SB	WB
Conflicting Lanes Right	3	2	3
HCM Control Delay	18	20.2	40.4
HCM LOS	C	C	E

Lane	NBLn1	NBLn2	NBLn3	EBLn1	EBLn2	EBLn3	WBLn1	WBLn2	WBLn3	SBLn1	SBLn2
Vol Left, %	100%	0%	0%	100%	0%	0%	100%	0%	0%	100%	0%
Vol Thru, %	0%	100%	0%	0%	100%	0%	0%	100%	0%	0%	80%
Vol Right, %	0%	0%	100%	0%	0%	100%	0%	0%	100%	0%	20%
Sign Control	Stop	Stop	Stop	Stop	Stop	Stop	Stop	Stop	Stop	Stop	Stop
Traffic Vol by Lane	156	346	98	35	133	130	67	180	208	61	148
LT Vol	0	346	0	0	133	0	0	180	0	0	119
Through Vol	0	0	98	0	0	130	0	0	208	0	29
RT Vol	156	0	0	35	0	0	67	0	0	61	0
Lane Flow Rate	171	380	108	42	160	157	74	198	229	66	159
Geometry Grp	8	8	8	8	8	8	8	8	8	8	8
Degree of Util (X)	0.441	0.925	0.241	0.119	0.431	0.39	0.2	0.509	0.542	0.186	0.423
Departure Headway (Hd)	9.269	8.762	8.051	10.189	9.674	8.953	9.769	9.255	8.536	10.204	9.567
Convergence, Y/N	Yes	Yes	Yes	Yes	Yes	Yes	Yes	Yes	Yes	Yes	Yes
Cap	387	414	445	351	372	401	367	390	421	351	376
Service Time	7.038	6.53	5.819	7.966	7.451	6.73	7.541	7.027	6.308	7.982	7.345
HCM Lane V/C Ratio	0.442	0.918	0.243	0.12	0.43	0.392	0.202	0.508	0.544	0.188	0.423
HCM Control Delay	19.2	57.6	13.4	14.3	19.6	17.4	15	21.3	21	15.3	19.2
HCM Lane LOS	C	F	B	B	C	C	B	C	C	C	C
HCM 95th-tile Q	2.2	10.1	0.9	0.4	2.1	1.8	0.7	2.8	3.1	0.7	2

Intersection

Intersection Delay, s/veh
 Intersection LOS

Movement	SBU	SBL	SBT	SBR
Vol, veh/h	0	61	119	29
Peak Hour Factor	0.92	0.93	0.93	0.93
Heavy Vehicles, %	2	2	2	2
Mvmt Flow	0	66	128	31
Number of Lanes	0	1	1	0

Approach	SB
Opposing Approach	NB
Opposing Lanes	3
Conflicting Approach Left	WB
Conflicting Lanes Left	3
Conflicting Approach Right	EB
Conflicting Lanes Right	3
HCM Control Delay	18.1
HCM LOS	C

Lane

HCM 2010 Roundabout
 9003: Nixon Rd & Dhu Varren Rd/Green Road

9/9/2014

Intersection

Intersection Delay, s/veh 20.3
 Intersection LOS C

Approach	EB	WB	NB	SB
Entry Lanes	1	1	1	1
Conflicting Circle Lanes	1	1	1	1
Adj Approach Flow, veh/h	359	501	659	225
Demand Flow Rate, veh/h	366	506	672	230
Vehicles Circulating, veh/h	273	605	273	449
Vehicles Exiting, veh/h	406	340	366	662
Follow-Up Headway, s	3.186	3.186	3.186	3.186
Ped Vol Crossing Leg, #/h	0	0	0	0
Ped Cap Adj	1.000	1.000	1.000	1.000
Approach Delay, s/veh	9.5	31.3	21.6	9.1
Approach LOS	A	D	C	A

Lane	Left	Left	Left	Left
Designated Moves	LTR	LTR	LTR	LTR
Assumed Moves	LTR	LTR	LTR	LTR
RT Channelized				
Lane Util	1.000	1.000	1.000	1.000
Critical Headway, s	5.193	5.193	5.193	5.193
Entry Flow, veh/h	366	506	672	230
Cap Entry Lane, veh/h	860	617	860	721
Entry HV Adj Factor	0.980	0.990	0.981	0.980
Flow Entry, veh/h	359	501	659	225
Cap Entry, veh/h	843	611	844	707
V/C Ratio	0.426	0.820	0.781	0.319
Control Delay, s/veh	9.5	31.3	21.6	9.1
LOS	A	D	C	A
95th %tile Queue, veh	2	8	8	1

HCM 2010 Roundabout
 9003: Nixon Rd & Dhu Varren Rd/Green Road

9/9/2014

Intersection

Intersection Delay, s/veh 11.0
 Intersection LOS B

Approach	EB	WB	NB	SB
Entry Lanes	2	2	2	2
Conflicting Circle Lanes	1	1	1	1
Adj Approach Flow, veh/h	359	501	659	225
Demand Flow Rate, veh/h	366	506	672	230
Vehicles Circulating, veh/h	273	605	273	449
Vehicles Exiting, veh/h	406	340	366	662
Follow-Up Headway, s	3.186	3.186	3.186	3.186
Ped Vol Crossing Leg, #/h	0	0	0	0
Ped Cap Adj	1.000	1.000	1.000	1.000
Approach Delay, s/veh	6.5	12.1	13.6	8.0
Approach LOS	A	B	B	A

Lane	Left	Right	Left	Right	Left	Right	Left	Right
Designated Moves	LT	R	LT	R	LT	R	LT	R
Assumed Moves	LT	R	LT	R	LT	R	LT	R
RT Channelized								
Lane Util	0.563	0.437	0.543	0.457	0.836	0.164	0.861	0.139
Critical Headway, s	5.193	5.193	5.193	5.193	5.193	5.193	5.193	5.193
Entry Flow, veh/h	206	160	275	231	562	110	198	32
Cap Entry Lane, veh/h	860	860	617	617	860	860	721	721
Entry HV Adj Factor	0.980	0.981	0.989	0.991	0.981	0.982	0.982	0.969
Flow Entry, veh/h	202	157	272	229	551	108	194	31
Cap Entry, veh/h	842	844	610	612	844	844	708	699
V/C Ratio	0.240	0.186	0.446	0.374	0.653	0.128	0.275	0.044
Control Delay, s/veh	6.8	6.2	12.8	11.2	15.2	5.5	8.4	5.6
LOS	A	A	B	B	C	A	A	A
95th %tile Queue, veh	1	1	2	2	5	0	1	0

Lanes, Volumes, Timings
 9003: Nixon Rd & Dhu Varren Rd/Green Road

9/9/2014

Lane Group	EBL	EBT	EBR	WBL	WBT	WBR	NBL	NBT	NBR	SBL	SBT	SBR
Lane Configurations												
Volume (vph)	35	133	130	67	180	208	156	346	98	61	119	29
Ideal Flow (vphpl)	1900	1900	1900	1900	1900	1900	1900	1900	1900	1900	1900	1900
Storage Length (ft)	150		150	180		180	150		150	150		0
Storage Lanes	1		1	1		1	1		1	1		0
Taper Length (ft)	25			25			25			25		
Lane Util. Factor	1.00	1.00	1.00	1.00	1.00	1.00	1.00	1.00	1.00	1.00	1.00	1.00
Frt			0.850			0.850			0.850		0.971	
Flt Protected	0.950			0.950			0.950			0.950		
Satd. Flow (prot)	1770	1863	1583	1787	1881	1599	1770	1863	1583	1770	1809	0
Flt Permitted	0.563			0.627			0.651			0.378		
Satd. Flow (perm)	1049	1863	1583	1180	1881	1599	1213	1863	1583	704	1809	0
Right Turn on Red			Yes			Yes			Yes			Yes
Satd. Flow (RTOR)			157			229			152		16	
Link Speed (mph)		35			25			30			30	
Link Distance (ft)		1081			887			610			700	
Travel Time (s)		21.1			24.2			13.9			15.9	
Peak Hour Factor	0.83	0.83	0.83	0.91	0.91	0.91	0.91	0.91	0.91	0.93	0.93	0.93
Heavy Vehicles (%)	2%	2%	2%	1%	1%	1%	2%	2%	2%	2%	2%	2%
Adj. Flow (vph)	42	160	157	74	198	229	171	380	108	66	128	31
Shared Lane Traffic (%)												
Lane Group Flow (vph)	42	160	157	74	198	229	171	380	108	66	159	0
Turn Type	pm+pt	NA	Perm	pm+pt	NA	Perm	pm+pt	NA	Perm	pm+pt	NA	
Protected Phases	7	4		3	8		5	2		1	6	
Permitted Phases	4		4	8		8	2		2	6		
Minimum Split (s)	9.0	21.0	21.0	9.0	21.0	21.0	9.0	21.0	21.0	9.0	21.0	
Total Split (s)	10.0	29.0	29.0	10.0	29.0	29.0	10.0	37.0	37.0	10.0	37.0	
Total Split (%)	11.6%	33.7%	33.7%	11.6%	33.7%	33.7%	11.6%	43.0%	43.0%	11.6%	43.0%	
Yellow Time (s)	3.5	3.5	3.5	3.5	3.5	3.5	3.5	3.5	3.5	3.5	3.5	
All-Red Time (s)	1.5	1.5	1.5	1.5	1.5	1.5	1.5	1.5	1.5	1.5	1.5	
Lost Time Adjust (s)	0.0	0.0	0.0	0.0	0.0	0.0	0.0	0.0	0.0	0.0	0.0	
Total Lost Time (s)	5.0	5.0	5.0	5.0	5.0	5.0	5.0	5.0	5.0	5.0	5.0	
Lead/Lag	Lead	Lag	Lag	Lead	Lag	Lag	Lead	Lag	Lag	Lead	Lag	
Lead-Lag Optimize?	Yes	Yes	Yes	Yes	Yes	Yes	Yes	Yes	Yes	Yes	Yes	
Act Effct Green (s)	29.0	24.0	24.0	29.0	24.0	24.0	37.0	32.0	32.0	37.0	32.0	
Actuated g/C Ratio	0.34	0.28	0.28	0.34	0.28	0.28	0.43	0.37	0.37	0.43	0.37	
v/c Ratio	0.11	0.31	0.28	0.17	0.38	0.37	0.31	0.55	0.16	0.18	0.23	
Control Delay	17.1	26.5	5.7	17.7	27.6	5.5	15.0	25.0	1.8	13.2	17.7	
Queue Delay	0.0	0.0	0.0	0.0	0.0	0.0	0.0	0.0	0.0	0.0	0.0	
Total Delay	17.1	26.5	5.7	17.7	27.6	5.5	15.0	25.0	1.8	13.2	17.7	
LOS	B	C	A	B	C	A	B	C	A	B	B	
Approach Delay		16.3			16.0			18.6			16.4	
Approach LOS		B			B			B			B	
Queue Length 50th (ft)	14	68	0	25	86	0	50	159	0	18	52	
Queue Length 95th (ft)	31	110	35	52	146	51	88	246	16	39	96	
Internal Link Dist (ft)		1001			807			530			620	
Turn Bay Length (ft)	150		150	180		180	150		150	150		
Base Capacity (vph)	395	519	554	433	524	611	554	693	684	364	683	
Starvation Cap Reductn	0	0	0	0	0	0	0	0	0	0	0	

Lanes, Volumes, Timings

9003: Nixon Rd & Dhu Varren Rd/Green Road

9/9/2014

Lane Group	EBL	EBT	EBR	WBL	WBT	WBR	NBL	NBT	NBR	SBL	SBT	SBR
Spillback Cap Reductn	0	0	0	0	0	0	0	0	0	0	0	0
Storage Cap Reductn	0	0	0	0	0	0	0	0	0	0	0	0
Reduced v/c Ratio	0.11	0.31	0.28	0.17	0.38	0.37	0.31	0.55	0.16	0.18	0.23	

Intersection Summary

Area Type: Other

Cycle Length: 86

Actuated Cycle Length: 86

Offset: 78 (91%), Referenced to phase 2:NBTL and 6:SBTL, Start of Green

Natural Cycle: 60

Control Type: Pretimed

Maximum v/c Ratio: 0.55

Intersection Signal Delay: 17.1

Intersection LOS: B

Intersection Capacity Utilization 51.1%

ICU Level of Service A

Analysis Period (min) 15

Splits and Phases: 9003: Nixon Rd & Dhu Varren Rd/Green Road

