

ENVIRONMENTAL IMPACTS OVERVIEW SHEET

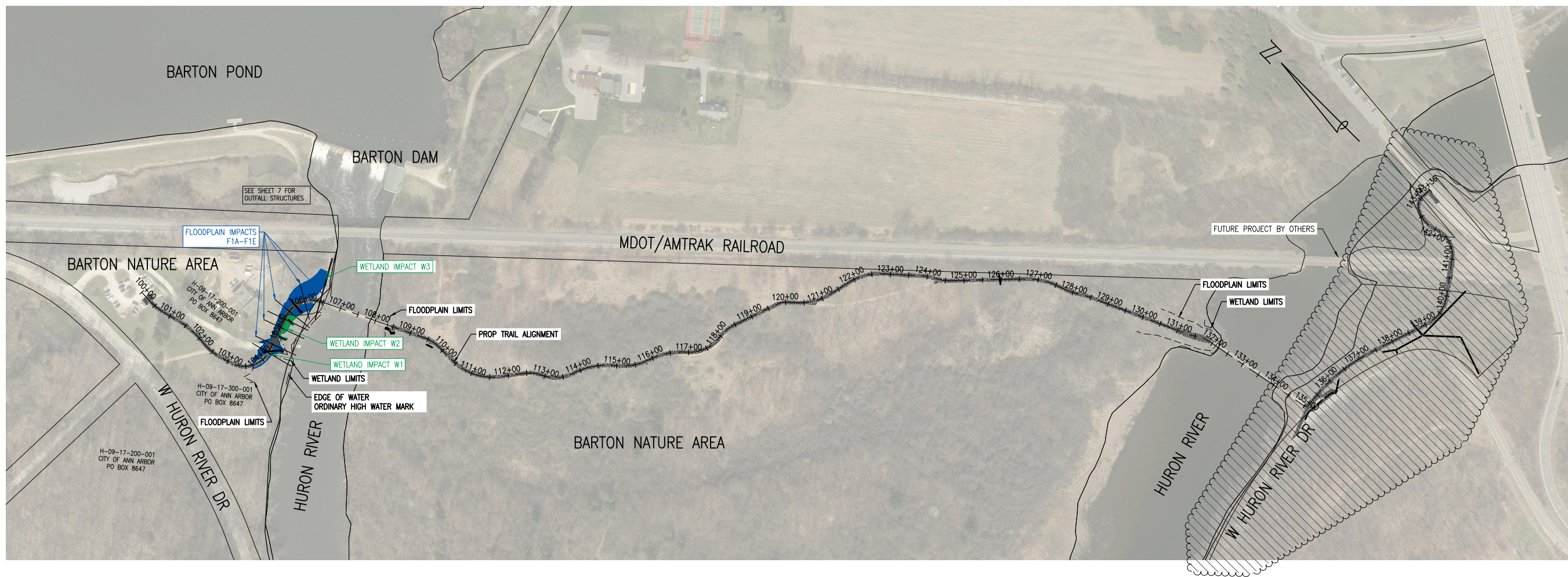

LOCATION MAP

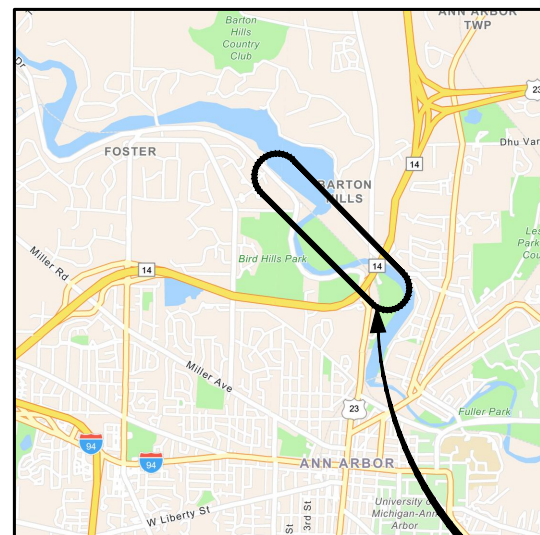

PROJECT LOCATION

WETLAND IMPACTS SUMMARY

IMPACT ID	WETLAND TYPE	IMPACT TYPE	LENGTH, FT	WIDTH, FT	DEPTH, FT	AREA, SFT	VOLUME, CFT	VOLUME, CYD
W1	PSS1	PERM	3	3	0.5	9	4.5	0
W2	PSS1	PERM	70	33	1.4	2310	3234	120
W3	PSS1	PERM	2	17	0.9	34	30.6	1
TOTAL THIS SHEET	ALL					2353 SFT 0.05 AC	3269.1	121

PSS1=PALUSTRINE, SCRUB SHRUB, BROAD-LEAVED DECIDUOUS

FLOODPLAIN IMPACTS SUMMARY

IMPACT ID	IMPACT TYPE	LENGTH, FT	WIDTH, FT	DEPTH, FT	AREA, SFT	VOLUME, CFT	VOLUME, CYD
F1A	FILL	106	10	0.5	1060	522	19
F1B	FILL	44	29	0.7	1276	897	33
F1C	FILL	49	38	1.0	1862	1884	70
F1D	FILL	43	50	1.5	2150	3184	118
F1E	FILL	31	32	0.9	992	893	33
TOTAL FLOODPLAIN FILL							273 CYD

LEGEND

- PERMANENT WETLAND IMPACT
- FLOODPLAIN FILL

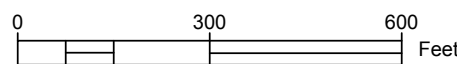

Know what's below.
Call before you dig.

CITY OF ANN ARBOR PRS & WASHTENAW COUNTY PRC
 BARTON NATURE AREA BORDER TO BORDER TRAIL
 ENVIRONMENTAL IMPACTS OVERVIEW

WRP040020 v1.0
 Applied
 Issued 01/09/2024
 Expires On: 01/09/2029

FLOODPLAIN IMPACTS

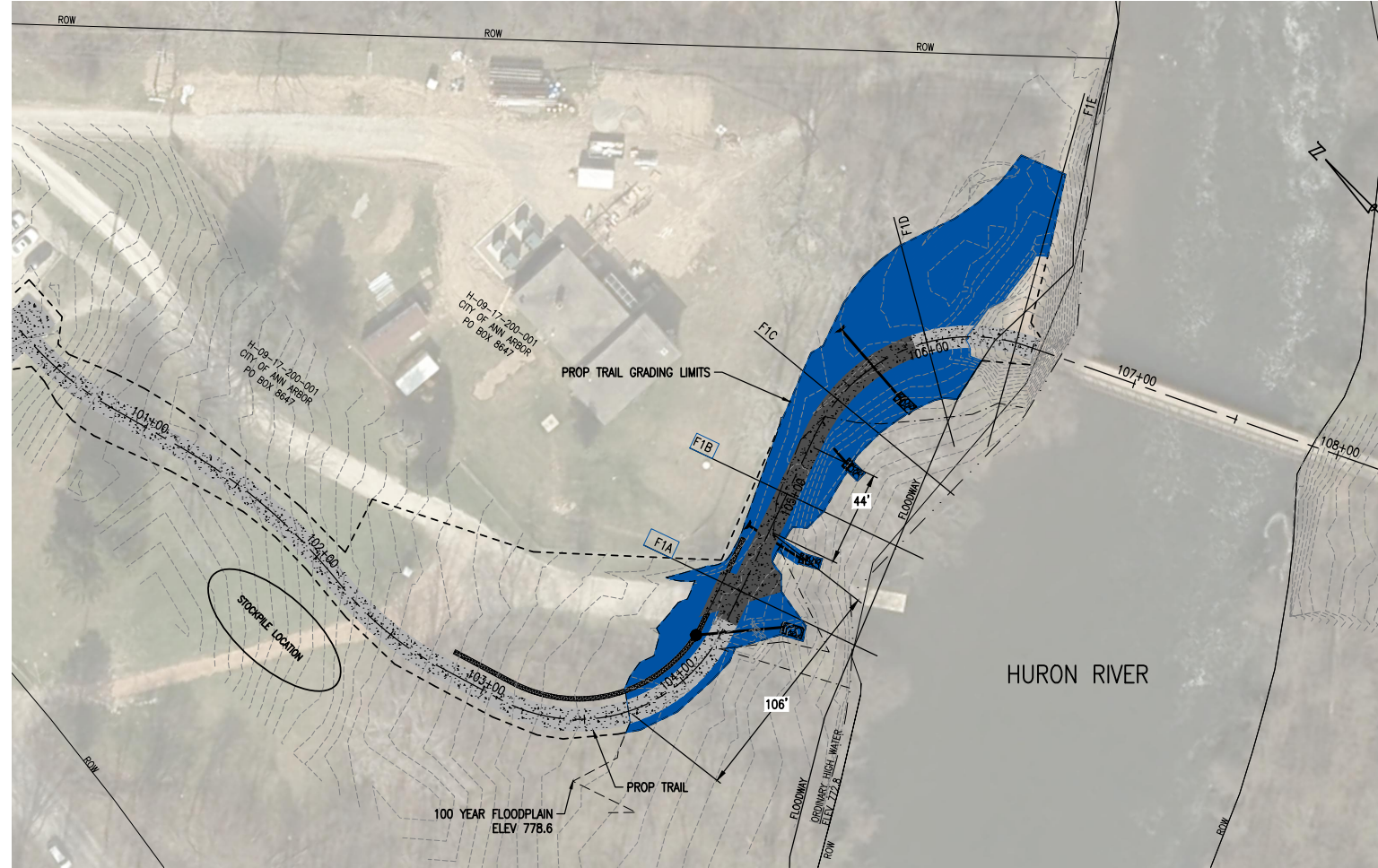

LOCATION MAP

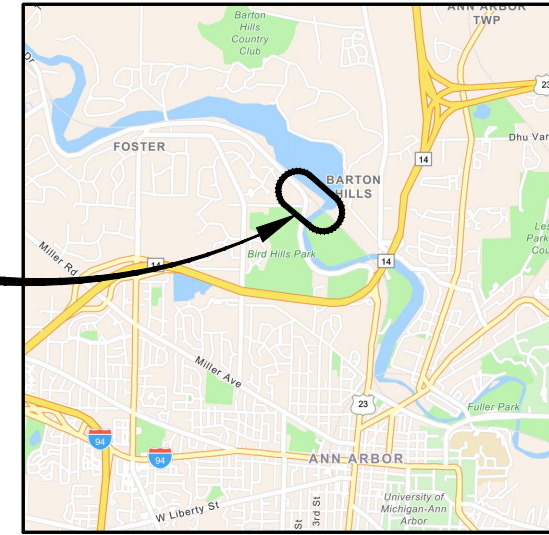

IMPACTS THIS SHEET

ARCHITECTS ENGINEERS PLANNERS
 34000 Plymouth Road
 Livonia, MI 48150
 P (734) 522-6711 | F (734) 522-6427
 OHM-ADVISORS.COM

REVISIONS:

F1A STA 104+50.00

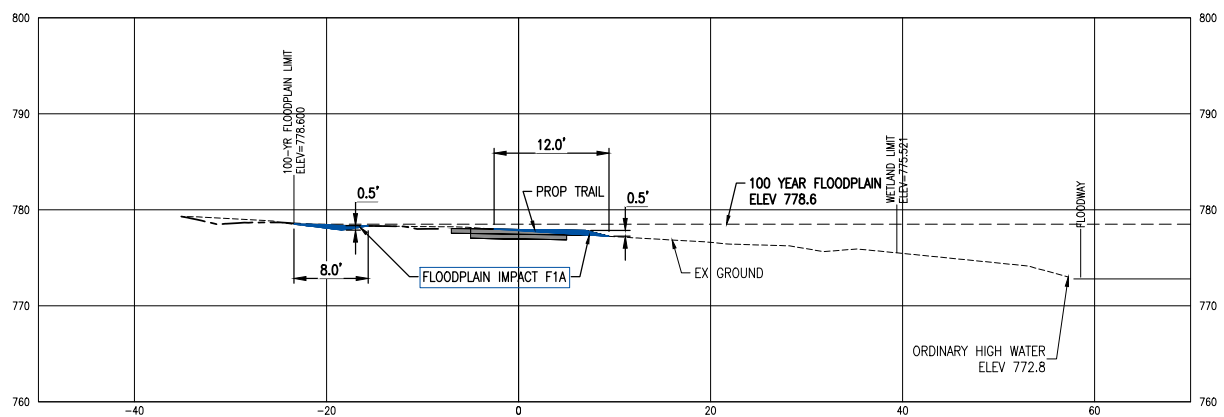

F1B STA 105+00.00

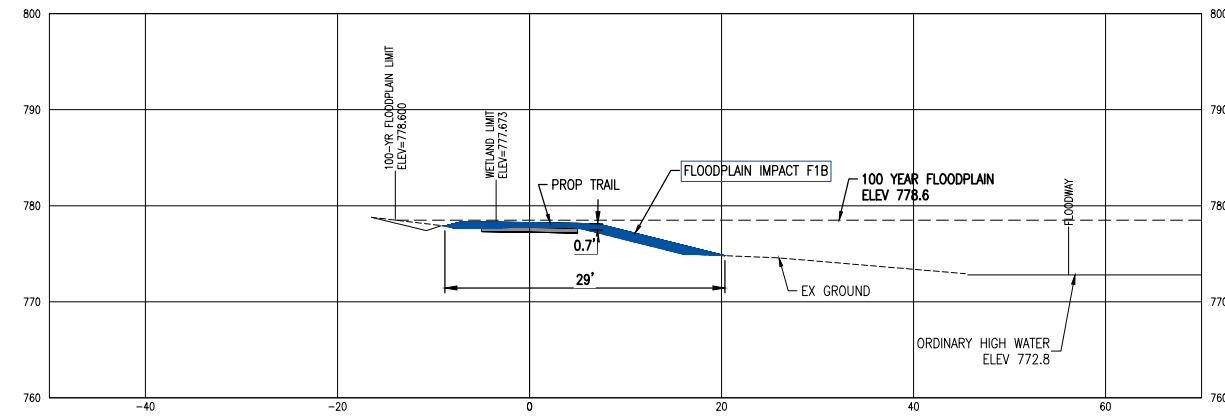

LEGEND
 FLOODPLAIN FILL

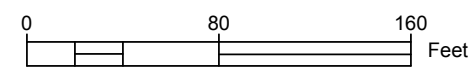

Know what's below.
 Call before you dig.

CITY OF ANN ARBOR PRS & WASHTENAW COUNTY PRC
 BARTON NATURE AREA BORDER TO BORDER TRAIL
 FLOODPLAIN IMPACTS

WRP040020 v1.0
 Approved
 Issued 01/09/2024
 Expires On: 01/09/2029

DRAWING PATH: P:\1000 - 1999\1022\80010_Bandemer-Barton_Trail\Drawings\Civil\Misc\PA180010.PA.dwg Oct 17, 2023 - 8:16am

COPYRIGHT 2017 OHM ALL DRAWINGS AND WRITTEN MATERIALS APPEARING HEREIN CONSTITUTE THE ORIGINAL AND UNPUBLISHED WORK OF OHM AND THE SAME MAY NOT BE DUPLICATED, DISTRIBUTED, OR DISCLOSED WITHOUT PRIOR WRITTEN CONSENT OF OHM

FLOODPLAIN IMPACTS



LOCATION MAP

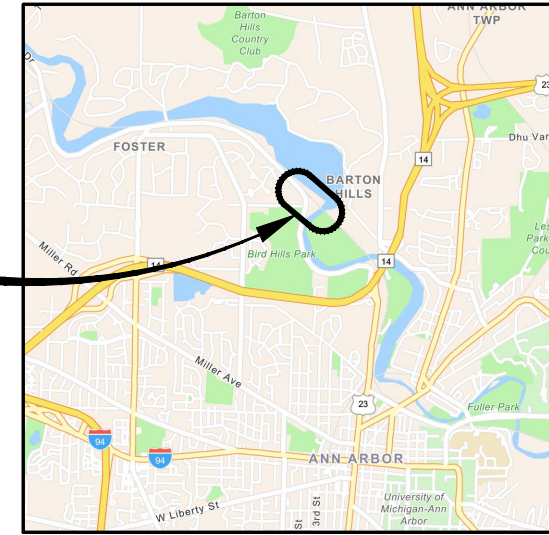

IMPACTS THIS SHEET

ARCHITECTS ENGINEERS PLANNERS
 34000 Plymouth Road
 Livonia, MI 48150
 P (734) 522-6711 | F (734) 522-6427
 OHM-ADVISORS.COM

REVISIONS:

DRAWING PATH: P:\1000-1999\1022\80010_Bandemer-Barton_Trail\Drawings\Civil\Misc\PA180010.PA.dwg Oct 17, 2023 - 8:16am

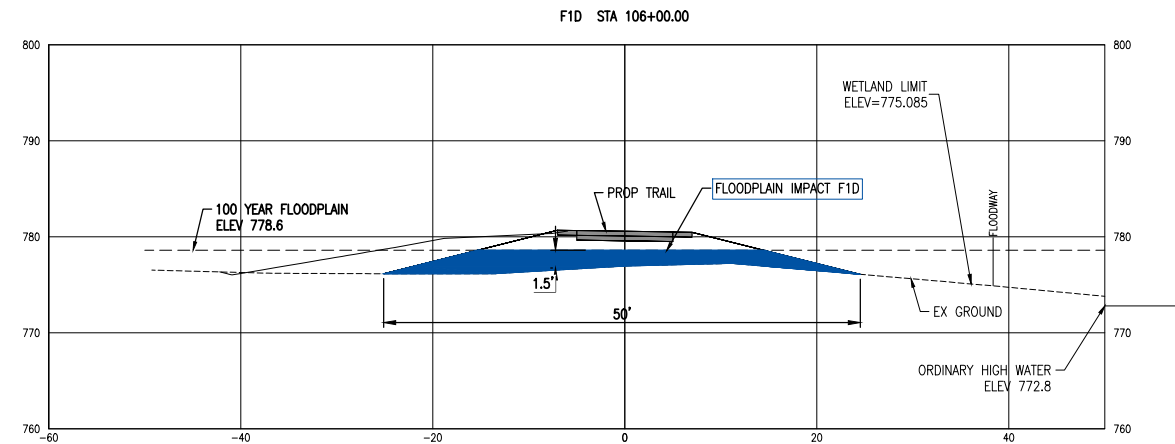
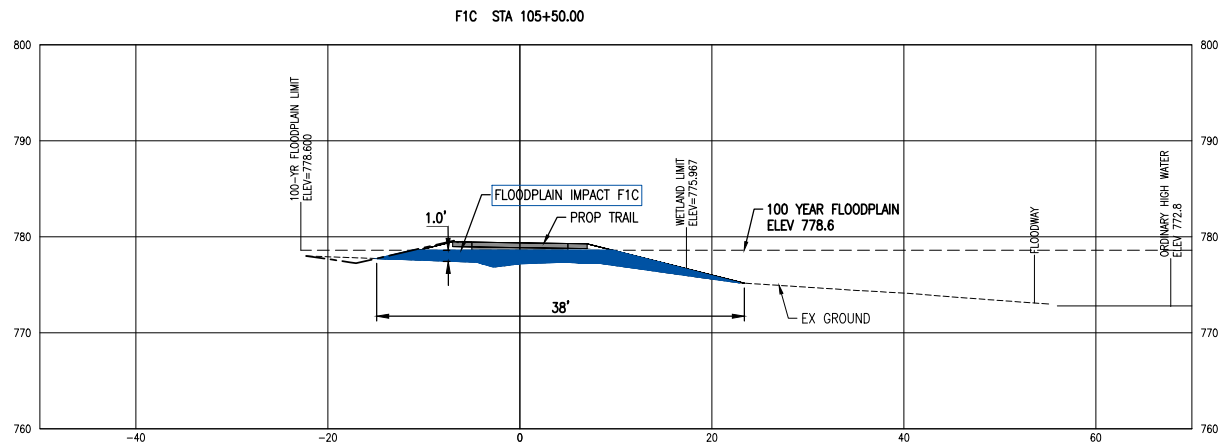

LEGEND

FLOODPLAIN FILL

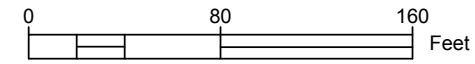

Know what's below.
 Call before you dig.

CITY OF ANN ARBOR PRS & WASHTENAW COUNTY PRC
 BARTON NATURE AREA BORDER TO BORDER TRAIL
 FLOODPLAIN IMPACTS

WRP040020 v1.0
 Approved 3
 Issued 01/09/2024
 Expires On: 01/09/2029

COPYRIGHT 2017 OHM ALL DRAWINGS AND WRITTEN MATERIALS APPEARING HEREIN CONSTITUTE THE ORIGINAL AND UNPUBLISHED WORK OF OHM AND THE SAME MAY NOT BE DUPLICATED, DISTRIBUTED, OR DISCLOSED WITHOUT PRIOR WRITTEN CONSENT OF OHM

FLOODPLAIN IMPACTS



LOCATION MAP

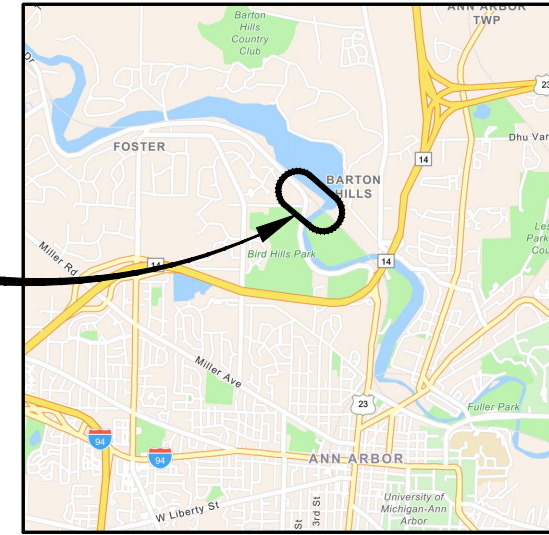

IMPACTS THIS SHEET

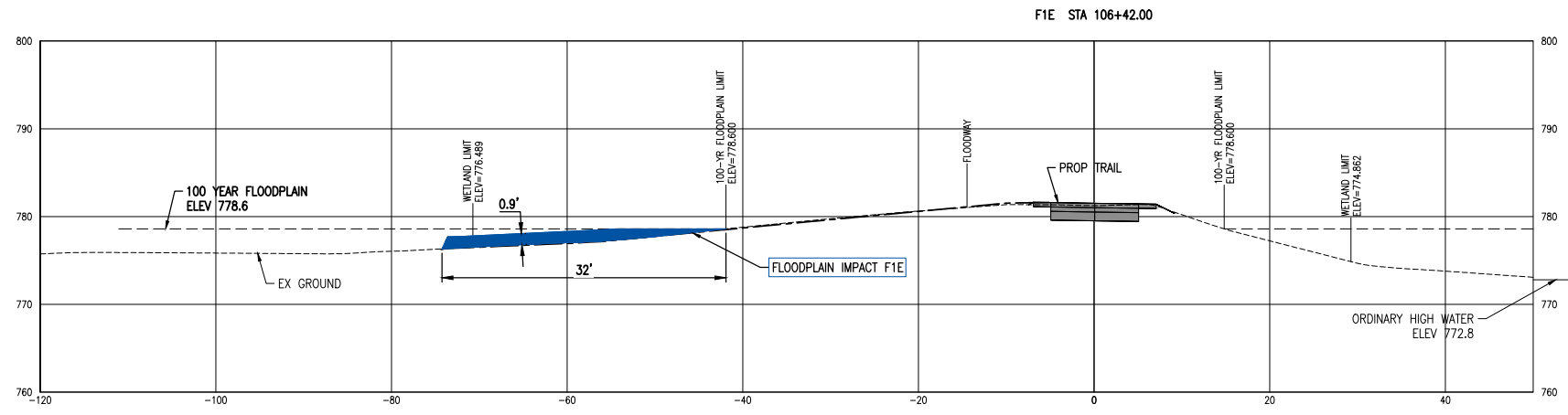

LEGEND

FLOODPLAIN FILL

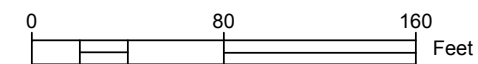

Know what's below.
Call before you dig.

REVISIONS:

CITY OF ANN ARBOR PRS & WASHTENAW COUNTY PRC
BARTON NATURE AREA BORDER TO BORDER TRAIL
FLOODPLAIN IMPACTS

DATE: 10/25/2021
SHEET: 4 OF 33

WRP040020 v1.0
App'd
Issued 01/09/2024
Expires On: 01/09/2029

DRAWING PATH: P:\1000-1999\1022\80010_BandemerBarton_Trail\Drawings\Civil\Misc\PA180510.PA.dwg Oct 17, 2023 - 6:17am

COPYRIGHT 2017 OHM ALL DRAWINGS AND WRITTEN MATERIALS APPEARING HEREIN CONSTITUTE THE ORIGINAL AND UNPUBLISHED WORK OF OHM AND THE SAME MAY NOT BE DUPLICATED, DISTRIBUTED, OR DISCLOSED WITHOUT PRIOR WRITTEN CONSENT OF OHM

WETLAND IMPACTS



LOCATION MAP

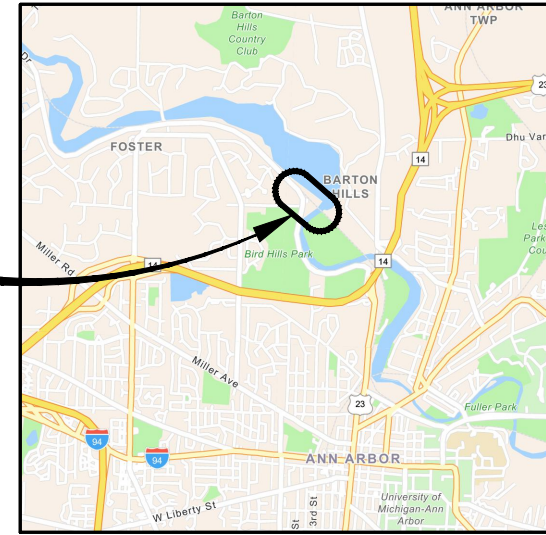

IMPACTS THIS SHEET

ARCHITECTS ENGINEERS PLANNERS
 34000 Plymouth Road
 Livonia, MI 48150
 P (734) 522-6711 | F (734) 522-6427
 OHM-ADVISORS.COM

REVISIONS:

NO. DATE

BY

DATE

BY

DATE

BY

DATE

BY

DATE

BY

DATE

BY

DATE

BY

DATE

BY

DATE

BY

DRAWING PATH: P:\1000-1999\1022\80010_Bandemer-Barton_Trail\Drawings\Civil\Misc\PA180010.PA.dwg Oct 17, 2023 - 6:17am

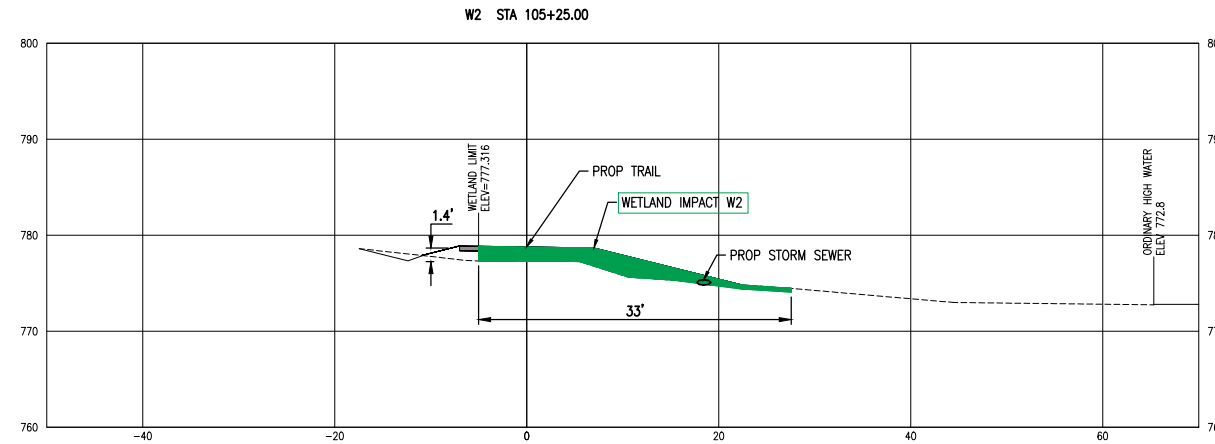
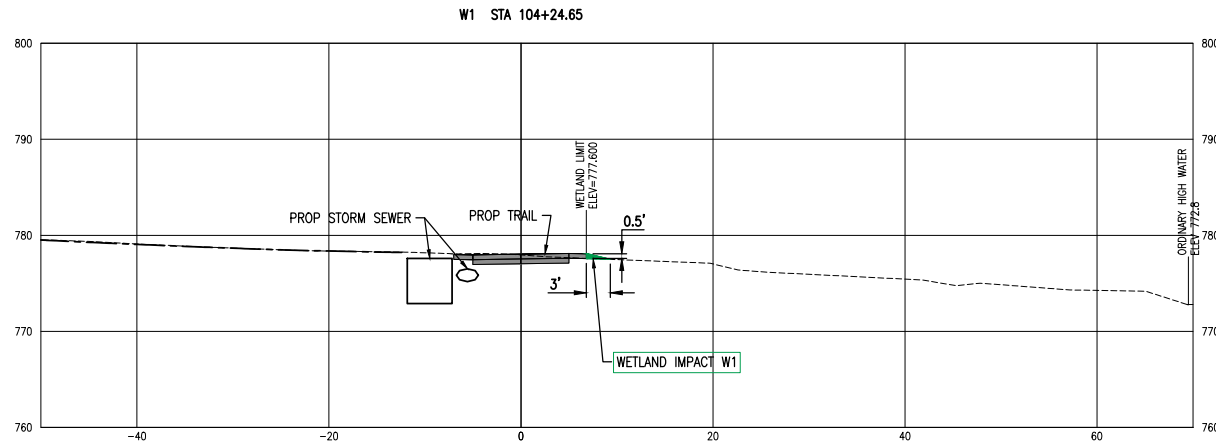

LEGEND



PERMANENT WETLAND IMPACT

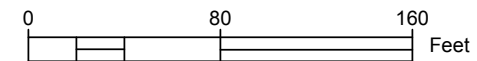

Know what's below.
 Call before you dig.

CITY OF ANN ARBOR PRS & WASHTENAW COUNTY PRC
 BARTON NATURE AREA BORDER TO BORDER TRAIL
 WETLAND IMPACTS

WRP040020 v1.0
 SHEET 5
 OF 31
 Issued On: 01/09/2024
 Expires On: 01/09/2029

COPYRIGHT 2017 OHM ALL DRAWINGS AND WRITTEN MATERIALS APPEARING HEREIN CONSTITUTE THE ORIGINAL AND UNPUBLISHED WORK OF OHM AND THE SAME MAY NOT BE DUPLICATED, DISTRIBUTED, OR DISCLOSED WITHOUT PRIOR WRITTEN CONSENT OF OHM

WETLAND IMPACTS

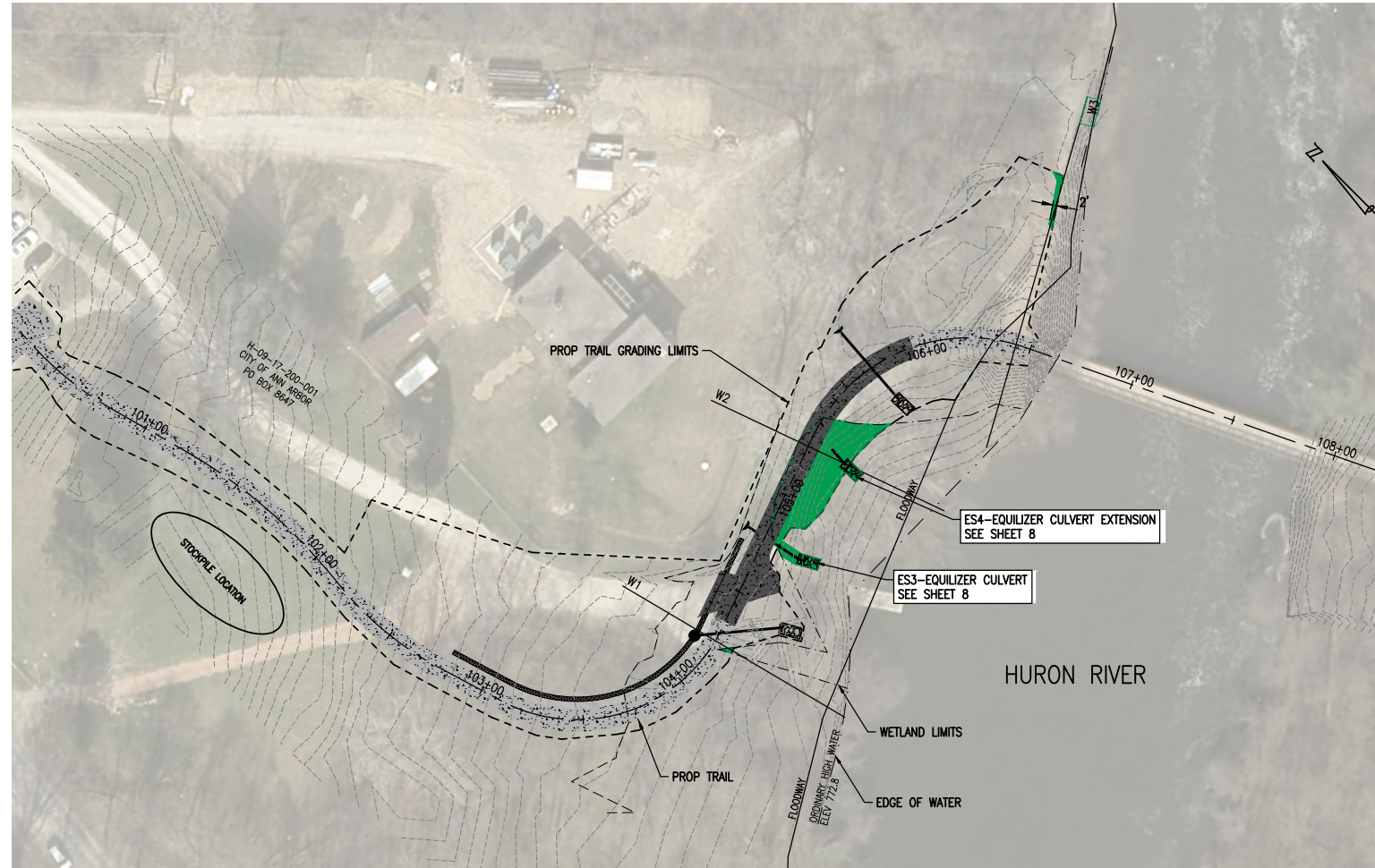

LOCATION MAP

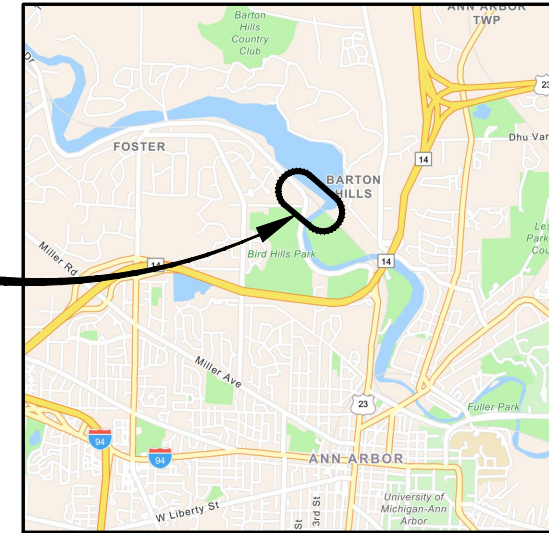

IMPACTS THIS SHEET

ARCHITECTS ENGINEERS PLANNERS
 34000 Plymouth Road
 Livonia, MI 48150
 P (734) 522-6711 | F (734) 522-6427
 OHM-ADVISORS.COM

REVISIONS:

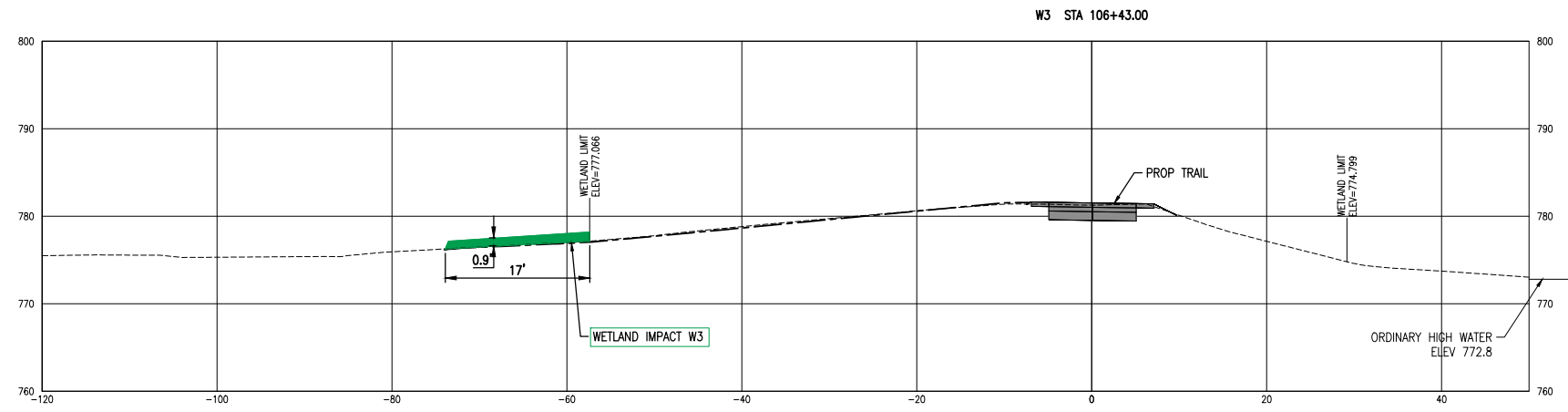

LEGEND

PERMANENT WETLAND IMPACT

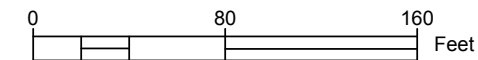

Know what's below.
 Call before you dig.

CITY OF ANN ARBOR PRS & WASHTENAW COUNTY PRC
 BARTON NATURE AREA BORDER TO BORDER TRAIL
 WETLAND IMPACTS

WRP040020 v1.0
 Approved
 Issued 09/01/2024
 Expires On: 01/09/2029

DRAWING PATH: P:\1000_1989\1022\80010_Bandemer-Barton_Trail\Drawings\Civil\Misc\PA180510\PA180510.dwg Oct 17, 2023 - 8:17am

COPYRIGHT 2017 OHM ALL DRAWINGS AND WRITTEN MATERIALS APPEARING HEREIN CONSTITUTE THE ORIGINAL AND UNPUBLISHED WORK OF OHM AND THE SAME MAY NOT BE DUPLICATED, DISTRIBUTED, OR DISCLOSED WITHOUT PRIOR WRITTEN CONSENT OF OHM

OUTFALL STRUCTURES

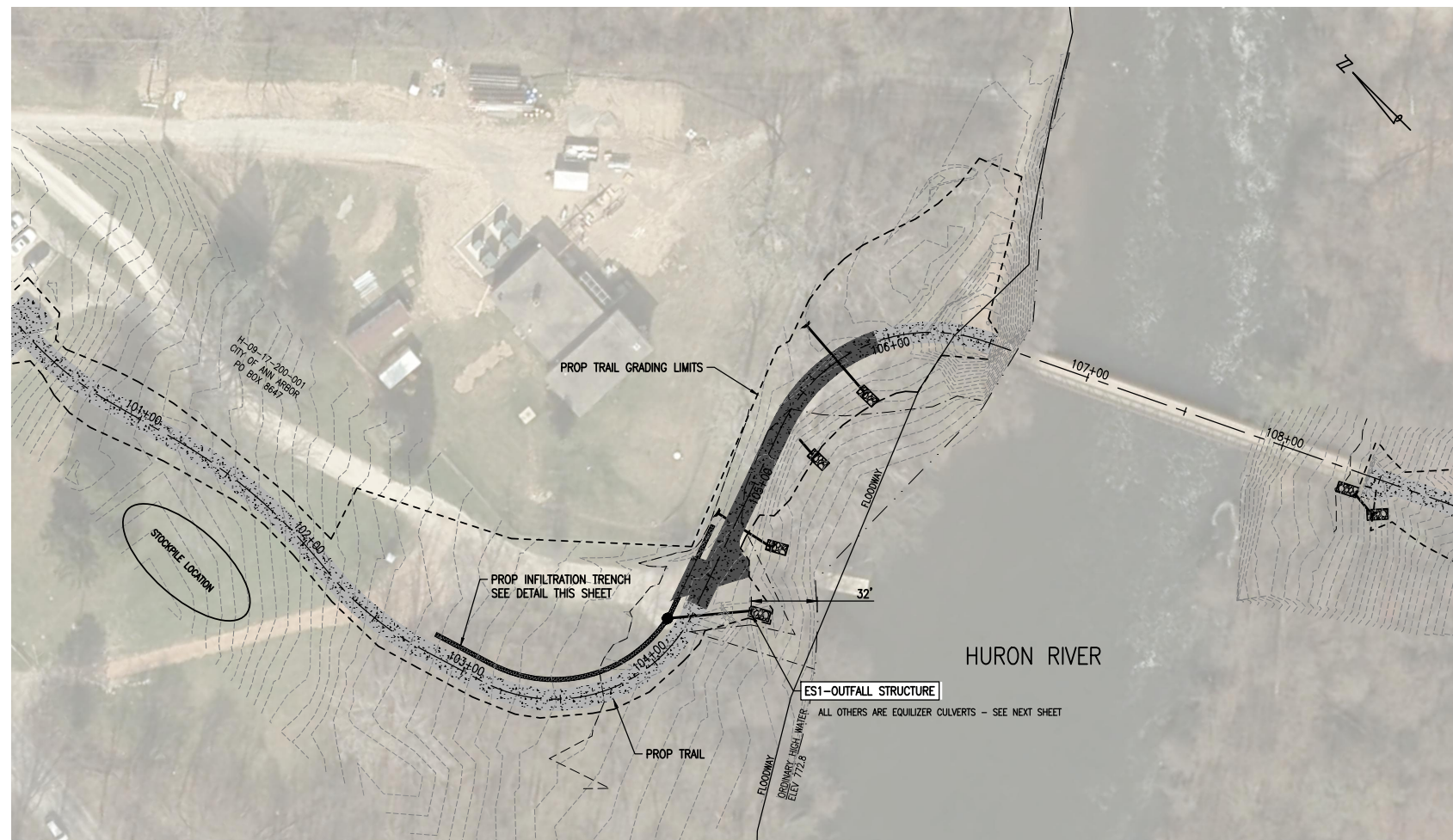

LOCATION MAP

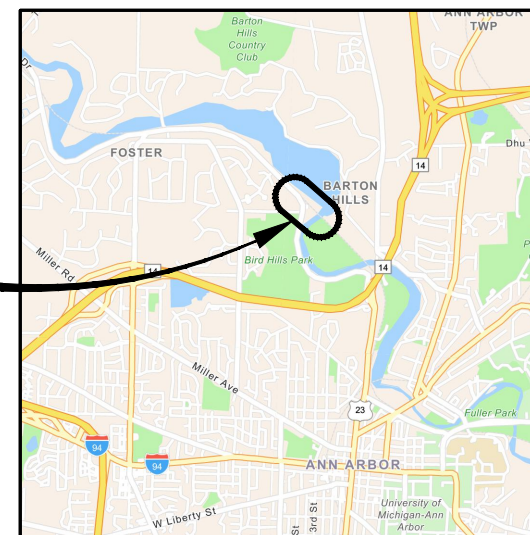

IMPACTS THIS SHEET

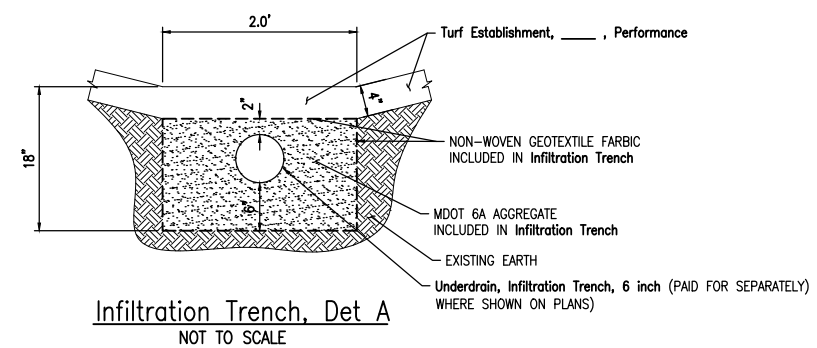
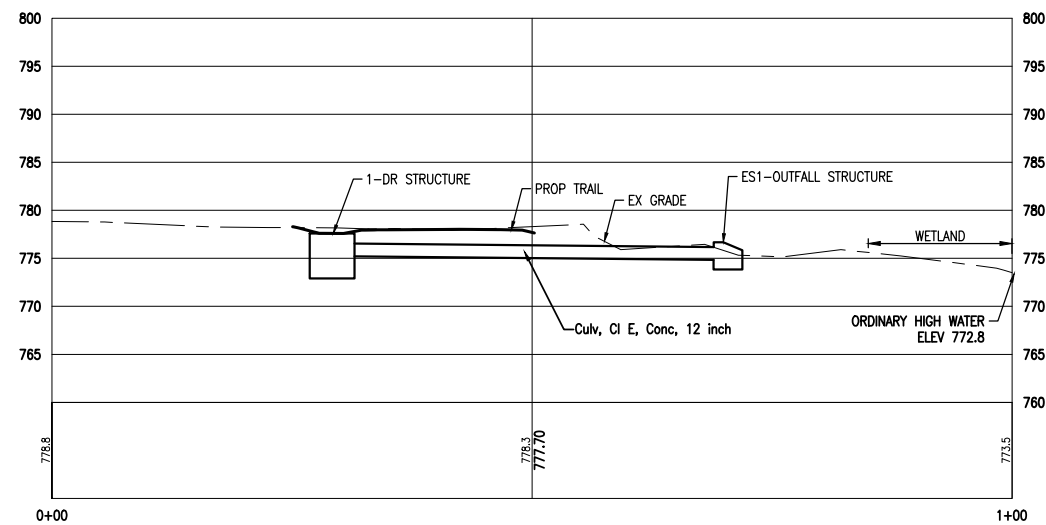
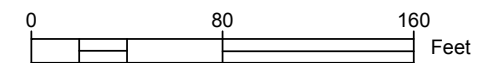

OHM
ARCHITECTS ENGINEERS PLANNERS
34000 Plymouth Road
Livonia, MI 48150
P (734) 522-6711 | F (734) 522-6427
OHM-ADVISORS.COM

REVISIONS:

CITY/TOWNSHIP: ANN ARBOR
COUNTY: WASHTENAW
SCALE: V. NA, H. NA
VERT DATUM: NAVD83
HORIZ DATUM: NAD83



Know what's below.
Call before you dig.

WRP040020 v1.0
Approved
Issued On: 01/09/2024
Expires On: 01/09/2029
CITY OF ANN ARBOR PRS & WASHTENAW COUNTY PRC
BARTON NATURE AREA BORDER TO BORDER TRAIL
OUTFALL STRUCTURES

DRAWING PATH: P:\1000-1999\1022\80010_Bandemer-Barton_Trail\Drawings\Civil\Misc\PA1\80010.PLA.dwg Oct 17, 2023 - 6:17am

COPYRIGHT 2017 OHM ALL DRAWINGS AND WRITTEN MATERIALS APPEARING HEREIN CONSTITUTE THE ORIGINAL AND UNPUBLISHED WORK OF OHM AND THE SAME MAY NOT BE DUPLICATED, DISTRIBUTED, OR DISCLOSED WITHOUT PRIOR WRITTEN CONSENT OF OHM.

EQUILIZER CULVERTS

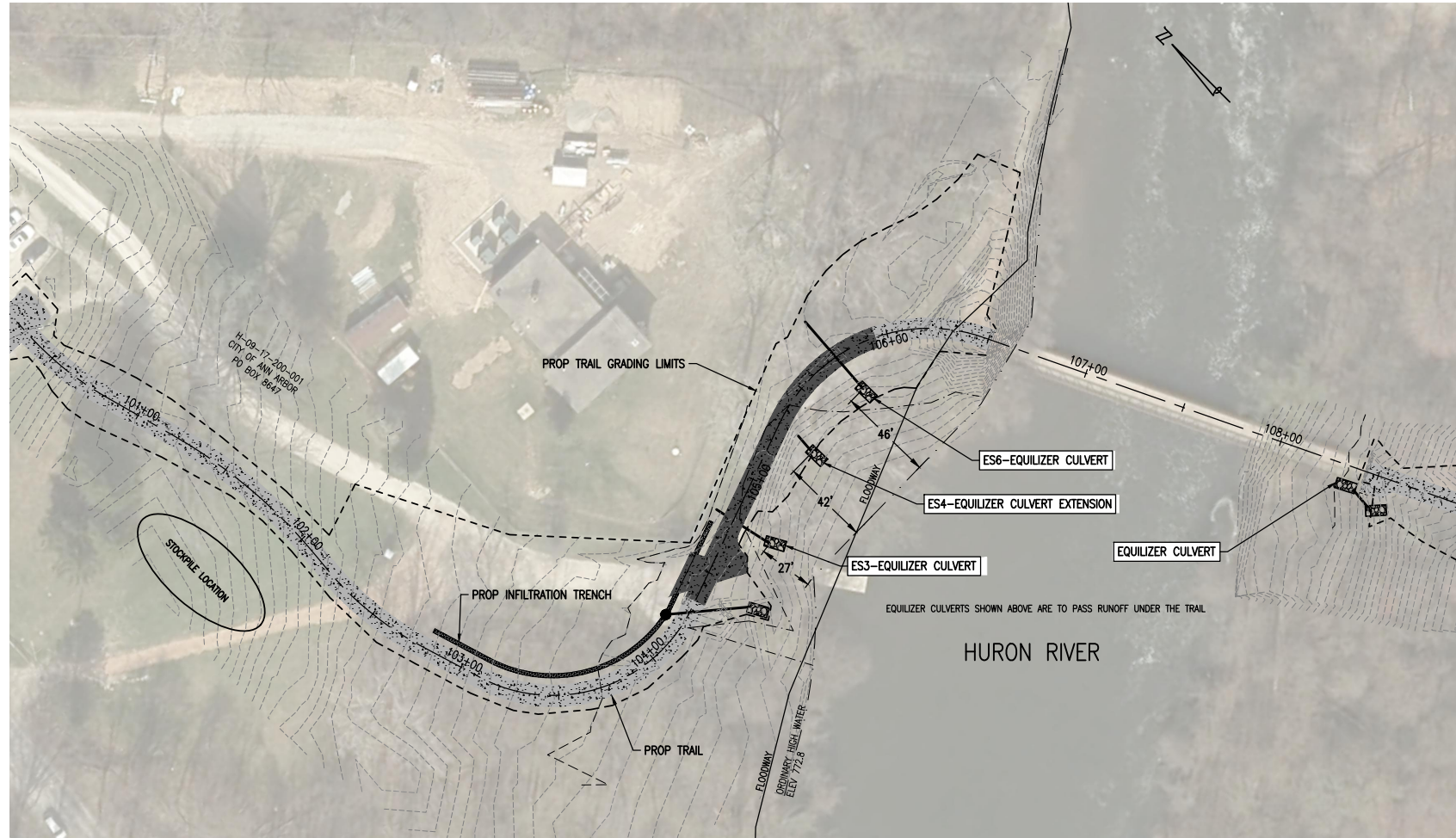

LOCATION MAP

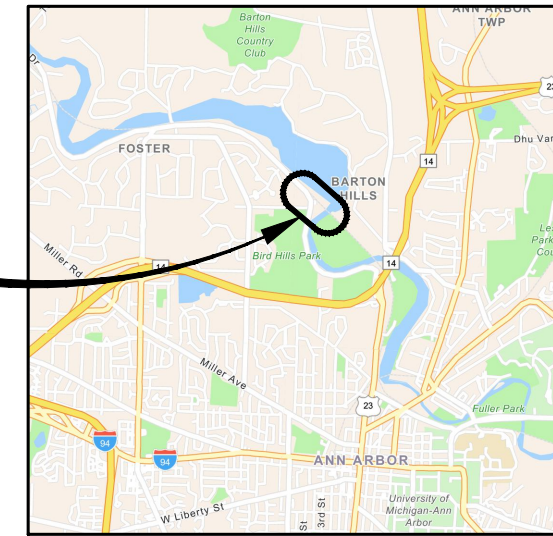

IMPACTS THIS SHEET

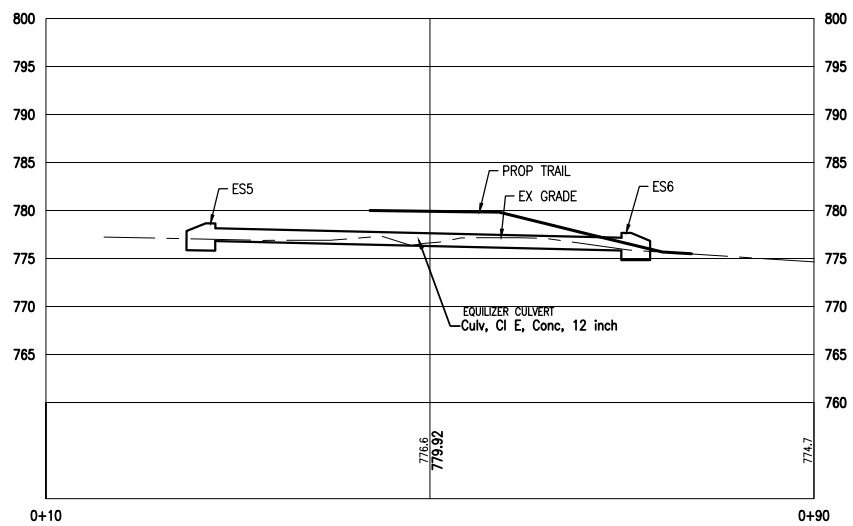
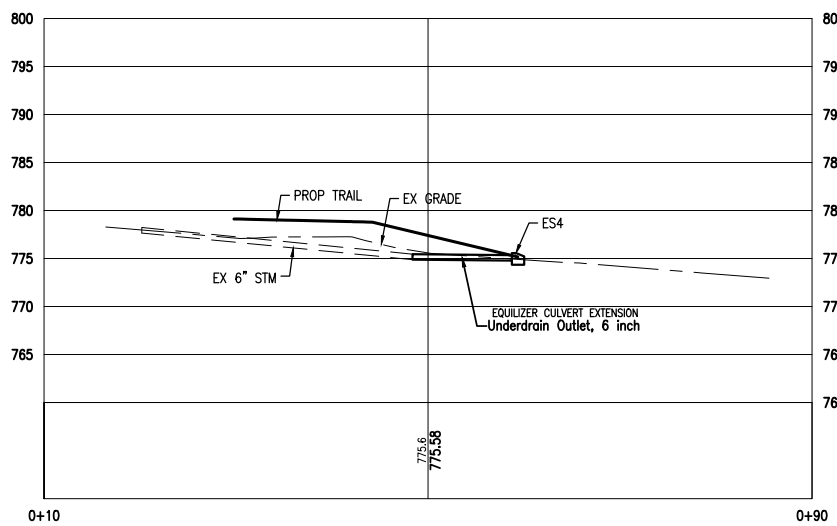
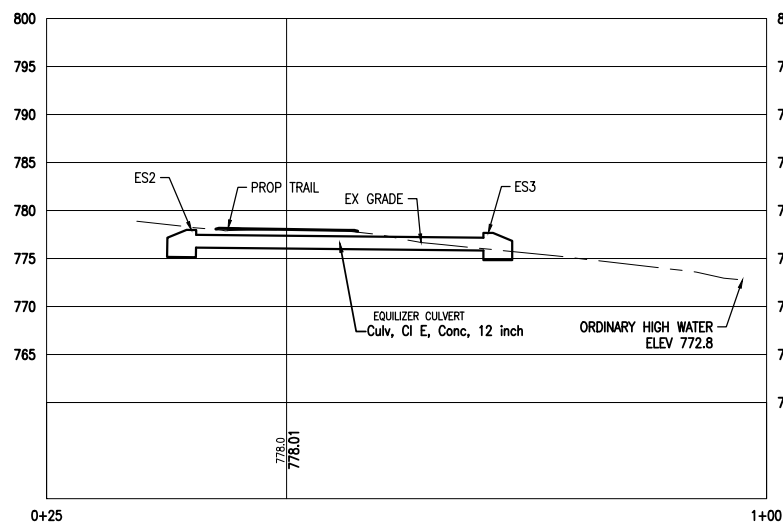
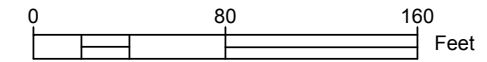

ARCHITECTS ENGINEERS PLANNERS

34000 Plymouth Road
Livonia, MI 48150
P (734) 522-6711 | F (734) 522-6427

OHM-ADVISORS.COM

REVISIONS:

DATE	PROJ NUMBER	ENG	PROJ MGR	CADD	COUNTY	CITY/TOWNSHIP	SCALE	HORIZ DATUM	VERT DATUM
10/22/2021	1022-162011	MB	CE	JK	WASHTENAW	CITY OF ANN ARBOR	AS SHOWN	NAD83	NAVD88

CITY OF ANN ARBOR PRS & WASHTENAW COUNTY PRC
BARTON NATURE AREA BORDER TO BORDER TRAIL
OUTFALL STRUCTURES



Know what's below.
Call before you dig.

WRP040020 v1.0
Approved
Issued 01/09/2024
7 OF 33
Expires On: 01/09/2029

DRAWING PATH: P:\1000 - 1999\1022\162011_Bandemer-Barton_Trail\Drawings\Civil\Misc\PA\162011\01PA.dwg Oct 17, 2023 - 6:17am

COPYRIGHT 2017 OHM ALL DRAWINGS AND WRITTEN MATERIALS APPEARING HEREIN CONSTITUTE THE ORIGINAL AND UNPUBLISHED WORK OF OHM AND THE SAME MAY NOT BE DUPLICATED, DISTRIBUTED, OR DISCLOSED WITHOUT PRIOR WRITTEN CONSENT OF OHM