

CITY OF ANN ARBOR
INVITATION TO BID



2019 RRFB Installations

ITB No. 4574

Due Date: Tuesday, March 26, 2019, at 10:00 a.m. (Local Time)

Public Services - Engineering

Issued By:

City of Ann Arbor
Procurement Unit
301 E. Huron Street
Ann Arbor, MI 48104

TABLE OF CONTENTS

TABLE OF CONTENTS.....	TC-1
NOTICE OF PRE-BID CONFERENCE.....	NP-1
INSTRUCTIONS TO BIDDERS.....	IB-1 to 5
INVITATION TO BID.....	ITB-1 to 3
BID FORMS.....	BF-1 to 5
CONTRACT.....	C-1 to 3
BOND FORMS.....	B-1 to 2
GENERAL CONDITIONS.....	GC-1 to 16
STANDARD SPECIFICATIONS.....	SS-1
DETAILED SPECIFICATION.....	DS-1 to 20
RRFB ASSEMBLY DETAILS.....	APDX-1
LOCATION MAP.....	APDX-2

ATTACHMENTS

City of Ann Arbor Prevailing Wage Declaration Form
City of Ann Arbor Living Wage Forms
City of Ann Arbor Vendor Conflict of Interest Disclosure Form
City of Ann Arbor Non-Discrimination Ordinance Notice and Declaration Form

NOTICE OF PRE-BID CONFERENCE

A pre-bid conference for this project will be held on **Tuesday, March 12, 2019 at 10:00 a.m.** at **Larcom City Hall, 301 E Huron Street, Engineering 4th Floor Conference Room.**

Attendance at this conference is highly recommended. Administrative and technical questions regarding this project will be answered at this time. The pre-bid conference is for information only. Any answers furnished will not be official until verified in writing by the Financial Service Area, Procurement Unit. Answers that change or substantially clarify the bid will be affirmed in an addendum.

INSTRUCTIONS TO BIDDERS

General

Work to be done under this Contract is generally described through the detailed specifications and must be completed fully in accordance with the contract documents. All work to be done under this Contract is located in or near the City of Ann Arbor.

Any Bid which does not conform fully to these instructions may be rejected.

Preparation of Bids

Bids should be prepared providing a straight-forward, concise description of the Bidder's ability to meet the requirements of the ITB. Bids shall be written in ink or typewritten. No erasures are permitted. Mistakes may be crossed out and corrected and must be initialed and dated in ink by the person signing the Bid.

Bids must be submitted on the "Bid Forms" provided with each blank properly filled in. If forms are not fully completed it may disqualify the bid. No alternative bid will be considered unless alternative bids are specifically requested. If alternatives are requested, any deviation from the specification must be fully described, in detail on the "Alternate" section of Bid form.

Each person signing the Bid certifies that he/she is the person in the Bidder's firm/organization responsible for the decision as to the fees being offered in the Bid and has not and will not participated in any action contrary to the terms of this provision.

Questions or Clarifications / Designated City Contacts

All questions regarding this ITB shall be submitted via email. Emailed questions and inquires will be accepted from any and all prospective Bidders in accordance with the terms and conditions of the ITB.

All questions shall be due on or before **Thursday, March 14, 2019 at 8:00 a.m.:** and should be addressed as follows:

Specification/Scope of Work questions emailed to bslizewski@a2gov.org
Bid Process and Compliance questions emailed to cspencer@a2gov.org

Any error, omissions or discrepancies in the specification discovered by a prospective contractor and/or service provider shall be brought to the attention of Brian Slizewski, PE, Public Services - Engineering at bslizewski@a2gov.org after discovery as possible. Further, the contractor and/or service provide shall not be allowed to take advantage of errors, omissions or discrepancies in the specifications.

Addenda

If it becomes necessary to revise any part of the ITB, notice of the Addendum will be posted to Michigan Inter-governmental Trade Network (MITN) www.mitn.info and/or City of Ann Arbor web site www.A2gov.org for all parties to download.

Each Bidder must in its Bid, to avoid any miscommunications, acknowledge all addenda which it has received, but the failure of a Bidder to receive, or acknowledge receipt of; any addenda shall not relieve the Bidder of the responsibility for complying with the terms thereof.

The City will not be bound by oral responses to inquiries or written responses other than written addenda.

Bid Submission

All Bids are due and must be delivered to the City of Ann Arbor Procurement Unit on or before **Tuesday, March 26, 2019, at 10:00 a.m. (local time)**. Bids submitted late or via oral, telephonic, telegraphic, electronic mail or facsimile **will not** be considered or accepted.

Each Bidder must submit one (1) original Bid and **one (1)** Bid copies in a sealed envelope clearly marked: **ITB No. 4574, 2019 RRFB Installations**.

Bids must be addressed and delivered to:

City of Ann Arbor
Procurement Unit,
c/o Customer Services, 1st Floor
301 East Huron Street
Ann Arbor, MI 48107

All Bids received on or before the Due Date will be publicly opened and recorded immediately. No immediate decisions are rendered.

The following forms provided within this ITB Document must be included in submitted bids.

- **City of Ann Arbor Prevailing Wage Declaration of Compliance**
- **City of Ann Arbor Living Wage Ordinance Declaration of Compliance**
- **Vendor Conflict of Interest Disclosure Form**
- **City of Ann Arbor Non-Discrimination Ordinance Declaration of Compliance**

Bids that fail to provide these completed forms listed above upon bid opening will be rejected as non-responsive and will not be considered for award.

Hand delivered bids will be date/time stamped/signed by the Procurement Unit at the address above in order to be considered. Normal business hours are 8:00 a.m. to 5:00 p.m. Monday through Friday, excluding Holidays. The City will not be liable to any Bidder for any unforeseen circumstances, delivery or postal delays. Postmarking to the Due Date will not substitute for receipt of the Bid. Each Bidder is responsible for submission of their Bid.

Additional time for submission of bids past the stated due date and time will not be granted to a single Bidder; however, additional time may be granted to all Bidders when the City determines in its sole discretion that circumstances warrant it.

Award

The City intends to award a Contract(s) to the lowest responsible Bidder(s). On multi-divisional contracts, separate divisions may be awarded to separate Bidders. The City may also utilize alternatives offered in the Bid Forms, if any, to determine the lowest responsible Bidder on each division, and award multiple divisions to a single Bidder, so that the lowest total cost is achieved for the City. For unit price bids, the Contract will be awarded based upon the unit prices and the lump sum prices stated by the bidder for the work items specified in the bid documents, with consideration given to any alternates selected by the City. If the City determines that the unit price for any item is materially different for the work item bid than either other bidders or the general market, the City, in its sole discretion, in addition to any other right it may have, may reject the bid

as not responsible or non-conforming.

The acceptability of major subcontractors will be considered in determining if a Bidder is responsible. In comparing Bids, the City will give consideration to alternate Bids for items listed in the bid forms. All key staff and subcontractors are subject to the approval by the City.

Official Documents

The City of Ann Arbor officially distributes bid documents from the Procurement Unit or through the Michigan Intergovernmental Trade Network (MITN). Copies of the bid documents obtained from any other source are not Official copies. Addenda and other bid information will only be posted to these official distribution sites. If you obtained City of Ann Arbor Bid documents from other sources, it is recommended that you register on www.MITN.info and obtain an official Bid. Bidders do not need to be shown on the plan holders list provided by MITN to be considered an official plan holder.

Bid Security

Each bid must be accompanied by a certified check, or Bid Bond by a surety licensed and authorized to do business within the State of Michigan, in the amount of 5% of the total of the bid price.

Withdrawal of Bids

After the time of opening, no Bid may be withdrawn for the period of ninety (90) days

Contract Time

Time is of the essence in the performance of the work under this Contract. The available time for work under this Contract is indicated on page C-1, Article III of the Contract. If these time requirements can not be met, the Bidder must stipulate on Bid Form Section 3 - Time Alternate its schedule for performance of the work. Consideration will be given to time in evaluating bids.

Liquidated Damages

A liquidated damages clause, as given on page C-2, Article III of the Contract, provides that the Contractor shall pay the City as liquidated damages, and not as a penalty, a sum certain per day for each and every day that the Contractor may be in default of completion of the specified work, within the time(s) stated in the Contract, or written extensions.

Liquidated damages clauses, as given in the General Conditions, provide further that the City shall be entitled to impose and recover liquidated damages for breach of the obligations under Chapter 112 of the City Code.

The liquidated damages are for the non-quantifiable aspects of any of the previously identified events and do not cover actual damages that can be shown or quantified nor are they intended to preclude recovery of actual damages in addition to the recovery of liquidated damages.

Human Rights Information

All contractors proposing to do business with the City shall satisfy the contract compliance administrative policy adopted by the City Administrator in accordance with the Section 9:158 of the Ann Arbor City Code. Breach of the obligation not to discriminate as outlined in Section 5, beginning at page GC-2 shall be a material breach of the contract. Contractors are required to post a copy of Ann Arbor's Non-Discrimination Ordinance attached at all work locations where its employees provide services under a contract with the City.

Wage Requirements

Section 4, beginning at page GC-1, outlines the requirements for payment of prevailing wages and for payment of a “living wage” to employees providing service to the City under this contract. The successful bidder and its subcontractors must comply with all applicable requirements and provide proof of compliance.

Pursuant to Resolution R-16-469 all public improvement contractors are subject to prevailing wage and will be required to provide to the City payroll records sufficient to demonstrate compliance with the prevailing wage requirements. Use of the Prevailing Wage Form provided in the Appendix section or a City-approved equivalent will be required along with wage rate interviews.

For laborers whose wage level are subject to federal, state and/or local prevailing wage law the appropriate Davis-Bacon wage rate classification is identified based upon the work including within this contract. **The wage determination(s) current on the date 10 days before bids are due shall apply to this contract.** The U.S. Department of Labor (DOL) has provided explanations to assist with classification in the following resource link: www.wdol.gov.

For the purposes of this ITB the Construction Type of **Highway** will apply.

Conflict Of Interest Disclosure

The City of Ann Arbor Purchasing Policy requires that prospective Vendors complete a Conflict of Interest Disclosure form. A contract may not be awarded to the selected Vendor unless and until the Procurement Unit and the City Administrator have reviewed the Disclosure form and determined that no conflict exists under applicable federal, state, or local law or administrative regulation. Not every relationship or situation disclosed on the Disclosure Form may be a disqualifying conflict. Depending on applicable law and regulations, some contracts may awarded on the recommendation of the City Administrator after full disclosure, where such action is allowed by law, if demonstrated competitive pricing exists and/or it is determined the award is in the best interest of the City. A copy of the Vendor Conflict of Interest Disclosure Form is attached.

Major Subcontractors

The Bidder shall identify on Bid Form Section 4 each major subcontractor it expects to engage for this Contract if the work to be subcontracted is 15% or more of the bid sum or over \$50,000, whichever is less. The Bidder also shall identify the work to be subcontracted to each major subcontractor. The Bidder shall not change or replace a subcontractor without approval by the City.

Debarment

Submission of a Bid in response to this ITB is certification that the Bidder is not currently debarred, suspended, proposed for debarment, and declared ineligible or voluntarily excluded from participation in this transaction by any State or Federal departments or agency. Submission is also agreement that the City will be notified of any changes in this status.

Disclosures

After bids are opened, all information in a submitter’s bid is subjected to disclosure under the provisions of Michigan Public Act No. 442 of 1976, as amended (MCL 15.231 et seq.) known as the “Freedom of Information Act.” The Freedom of Information Act also provides for the complete disclosure of contracts and attachments thereto except where specifically exempted.

Bid Protest

All Bid protests must be in writing and filed with the Purchasing Agent within five (5) business days of the award action. The bidder must clearly state the reasons for the protest. If a bidder contacts a City Service Area/Unit and indicates a desire to protest an award, the Service Area/Unit shall refer the bidder to the Purchasing Agent. The Purchasing Agent will provide the bidder with the appropriate instructions for filing the protest. The protest shall be reviewed by the City Administrator or designee whose decision shall be final.

Any inquiries or requests regarding this procurement should be only submitted in writing to the Designated City Contacts provided herein. Attempts by any prospective bidder to initiate contact with anyone other than the Designated City Contacts provided herein that the bidder believes can influence the procurement decision, e.g., Elected Officials, City Administrator, Selection Committee Members, Appointed Committee Members, etc., may lead to immediate elimination from further consideration.

Cost Liability

The City of Ann Arbor assumes no responsibility or liability for costs incurred by the Bidder prior to the execution of a contract with the City. By submitting a bid, a bidder agrees to bear all costs incurred or related to the preparation, submission and selection process for the bid.

Reservation of Rights

The City of Ann Arbor reserves the right to accept any bid or alternative bid proposed in whole or in part, to reject any or all bids or alternatives bids in whole or in part and to waive irregularity and/or informalities in any bid and to make the award in any manner deemed in the best interest of the City.

Idlefree Ordinance

The City of Ann Arbor adopted an idling reduction Ordinance that goes into effect July 1, 2017. The full text of the ordinance (including exemptions) can be found at: www.a2gov.org/idlefree.

Under the ordinance, No Operator of a Commercial Vehicle shall cause or permit the Commercial Vehicle to Idle:

- (a) For any period of time while the Commercial Vehicle is unoccupied; or
- (b) For more than 5 minutes in any 60-minute period while the Commercial Vehicle is occupied.

In addition, generators and other internal combustion engines are covered

(1) Excluding Motor Vehicle engines, no internal combustion engine shall be operated except when it is providing power or electrical energy to equipment or a tool that is actively in use.

Environmental Commitment

The City of Ann Arbor recognizes its responsibility to minimize negative impacts on human health and the environment while supporting a vibrant community and economy. The City further recognizes that the products and services the City buys have inherent environmental and economic impacts and that the City should make procurement decisions that embody, promote, and encourage the City's commitment to the environment.

The City encourages potential vendors to bring forward emerging and progressive products and services that are best suited to the City's environmental principles.

INVITATION TO BID

City of Ann Arbor
Guy C. Larcom Municipal Building
Ann Arbor, Michigan 48107

Ladies and Gentlemen:

The undersigned, as Bidder, declares that this Bid is made in good faith, without fraud or collusion with any person or persons bidding on the same Contract; that this Bidder has carefully read and examined the bid documents, including City Nondiscrimination requirements and Declaration of Compliance Form, Living Wage requirements and Declaration of Compliance Form, Prevailing Wage requirements and Declaration of Compliance Form, Vendor Conflict of Interest Form, Notice of Pre-Bid Conference, Instructions to Bidders, Bid, Bid Forms, Contract, Bond Forms, General Conditions, Standard Specifications, Detailed Specifications, all Addenda, and the Plans (if applicable) and understands them. The Bidder declares that it conducted a full investigation at the site and of the work proposed and is fully informed as to the nature of the work and the conditions relating to the work's performance. The Bidder also declares that it has extensive experience in successfully completing projects similar to this one.

The Bidder acknowledges that it has not received or relied upon any representations or warrants of any nature whatsoever from the City of Ann Arbor, its agents or employees, and that this Bid is based solely upon the Bidder's own independent business judgment.

The undersigned proposes to perform all work shown on the plans or described in the bid documents, including any addenda issued, and to furnish all necessary machinery, tools, apparatus, and other means of construction to do all the work, furnish all the materials, and complete the work in strict accordance with all terms of the Contract of which this Bid is one part.

In accordance with these bid documents, and Addenda numbered _____, the undersigned, as Bidder, proposes to perform at the sites in and/or around Ann Arbor, Michigan, all the work included herein for the amounts set forth in the Bid Forms.

The Bidder declares that it has become fully familiar with the liquidated damage clauses for completion times and for compliance with City Code Chapter 112, understands and agrees that the liquidated damages are for the non-quantifiable aspects of non-compliance and do not cover actual damages that may be shown and agrees that if awarded the Contract, all liquidated damage clauses form part of the Contract.

The Bidder declares that it has become fully familiar with the provisions of Chapter 14, Section 1:320 (Prevailing wages) and Chapter 23 (Living Wage) of the Code of the City of Ann Arbor and that it understands and agrees to comply, to the extent applicable to employees providing services to the City under this Contract, with the wage and reporting requirements stated in the City Code provisions cited. Bidder certifies that the statements contained in the City Prevailing Wage and Living Wage Declaration of Compliance Forms are true and correct. Bidder further agrees that the cited provisions of Chapter 14 and Chapter 23 form a part of this Contract.

The Bidder declares that it has become familiar with the City Conflict of Interest Disclosure Form and certifies that the statement contained therein is true and correct.

The Bidder encloses a certified check or Bid Bond in the amount of 5% of the total of the Bid Price. The Bidder agrees both to contract for the work and to furnish the necessary Bonds and insurance documentation within 10 days after being notified of the acceptance of the Bid.

If this Bid is accepted by the City and the Bidder fails to contract and furnish the required Bonds and insurance documentation within 10 days after being notified of the acceptance of this Bid, then the Bidder shall be considered to have abandoned the Contract and the certified check or Bid Bond accompanying this Bid shall become due and payable to the City.

If the Bidder enters into the Contract in accordance with this Bid, or if this Bid is rejected, then the accompanying check or Bid Bond shall be returned to the Bidder.

In submitting this Bid, it is understood that the right is reserved by the City to accept any Bid, to reject any or all Bids, to waive irregularities and/or informalities in any Bid, and to make the award in any manner the City believes to be in its best interest.

SIGNED THIS 20th DAY OF March, 2019.

J. Ranck Electric, Inc.

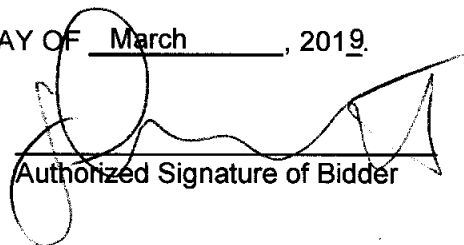
Bidder's Name

1993 Gover Parkway
Mt. Pleasant, MI 48858

Official Address

(989) 775-7393

Telephone Number



Authorized Signature of Bidder

Jim Levert

(Print Name of Signer Above)

ajranck@jranck.com

Email Address for Award Notice

LEGAL STATUS OF BIDDER

(The Bidder shall fill out the appropriate form and strike out the other three.)

Bidder declares that it is:

* A corporation organized and doing business under the laws of the State of Michigan, for whom Jim Levert, bearing the office title of Estimator, whose signature is affixed to this Bid, is authorized to execute contracts.

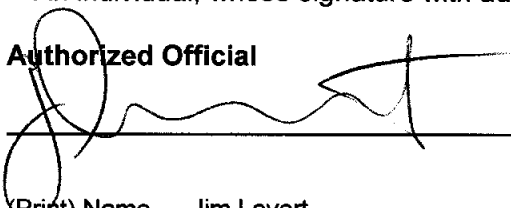
NOTE: If not incorporated in Michigan, please attach the corporation's Certificate of Authority

~~* A limited liability company doing business under the laws of the State of _____, whom _____ bearing the title of _____ whose signature is affixed to this proposal, is authorized to execute contract on behalf of the LLC.~~

~~* A partnership, organized under the laws of the state of _____ and filed in the county of _____, whose members are (list all members and the street and mailing address of each) (attach separate sheet if necessary):~~

* An individual, whose signature with address, is affixed to this Bid: _____ (initial here)

Authorized Official



Date March 20, 2019

(Print) Name Jim Levert Title Estimator

Company: J. Ranck Electric, Inc.

Address: 1993 Gover Parkway, Mt. Pleasant, MI 48858

Contact Phone (989) 775-7393 Fax (989) 775-8830

Email jlevert@jranck.com

COPY

BID FORM

Section 1 – Schedule of Prices

Company: J. Ranck Electric, Inc.

Project: 2019 RRFB Installations

File #: 2019-025 ITB No.: 4574

<u>Item</u>	<u>Description</u>	<u>Unit</u>	<u>Quantity</u>	<u>Unit Price</u>	<u>Total Price</u>
200	Certified Payroll Compliance And Reporting	L.S.	1	\$ <u>300.00</u>	\$ <u>300.00</u>
201	RRBB Installation, Type 2, on Green Road at Greenbrier Blvd	Each	2	\$ <u>9,545.00</u>	\$ <u>19,090.00</u>
202	RRBB Installation, Type 2, on Geddes Road east of Earhart Road	Each	2	\$ <u>9,545.00</u>	\$ <u>19,090.00</u>
203	RRBB Installation, Type 2, on N. Maple Road near S. Circle	Each	2	\$ <u>9,545.00</u>	\$ <u>19,090.00</u>
204	RRBB Installation, Type 2, on N. Maple Road between Pamela Ave and Sequoia Pkwy	Each	2	\$ <u>9,545.00</u>	\$ <u>19,090.00</u>
205	RRBB Installation, Type 2, on S. Maple Road, between Bens St and Russell St	Each	2	\$ <u>9,545.00</u>	\$ <u>19,090.00</u>
TOTAL BID \$					<u>95,750.00</u>

BID FORM

Section 2 – Material, Equipment and Environmental Alternates

The Base Bid proposal price shall include materials and equipment selected from the designated items and manufacturers listed in the bidding documents. This is done to establish uniformity in bidding and to establish standards of quality for the items named.

If the Contractor wishes to quote alternate items for consideration by the City, it may do so under this Section. A complete description of the item and the proposed price differential must be provided. Unless approved at the time of award, substitutions where items are specifically named will be considered only as a negotiated change in Contract Sum.

If an environmental alternative is bid the City strongly encourages bidders to provide recent examples of product testing and previous successful use for the City to properly evaluate the environmental alternative. Testing data from independent accredited organizations are strongly preferred.

<u>Item Number</u>	<u>Description</u>	<u>Add/Deduct Amount</u>
N/A		

If the Bidder does not suggest any material or equipment alternate, the Bidder **MUST** complete the following statement:

For the work outlined in this request for bid, the bidder does NOT propose any material or equipment alternate under the Contract.

Signature of Authorized Representative of Bidder  Date March 20, 2019

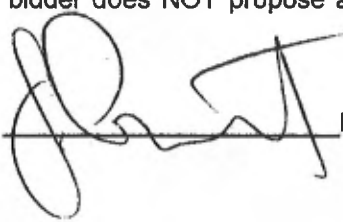
BID FORM

Section 3 - Time Alternate

If the Bidder takes exception to the time stipulated in Article III of the Contract, Time of Completion, page C-2, it is requested to stipulate below its proposed time for performance of the work. Consideration will be given to time in evaluating bids.

If the Bidder does not suggest any time alternate, the Bidder **MUST** complete the following statement:

For the work outlined in this request for bid, the bidder does NOT propose any time alternate under the Contract.

Signature of Authorized Representative of Bidder  Date March 20, 2019

BID FORM

Section 4 - Major Subcontractors

For purposes of this Contract, a Subcontractor is anyone (other than the Contractor) who performs work (other than or in addition to the furnishing of materials, plans or equipment) at or about the construction site, directly or indirectly for or on behalf of the Contractor (and whether or not in privity of Contract with the Contractor), but shall not include any individual who furnishes merely the individual's own personal labor or services.

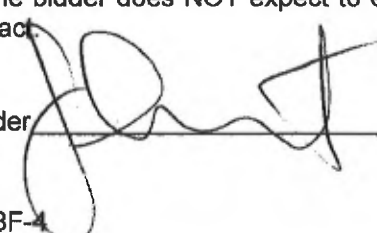
Contractor agrees that all subcontracts entered into by the Contractor shall contain similar wage provision to Section 4 of the General Conditions covering subcontractor's employees who perform work on this contract.

For the work outlined in these documents the Bidder expects to engage the following major subcontractors to perform the work identified:

<u>Subcontractor (Name and Address)</u>	<u>Work</u>	<u>Amount</u>
N/A		

If the Bidder does not expect to engage any major subcontractor, the Bidder **MUST** complete the following statement:

For the work outlined in this request for bid, the bidder does NOT expect to engage any major subcontractor to perform work under the Contract.

Signature of Authorized Representative of Bidder  Date March 20, 2019

BID FORM

Section 5 – References

Include a minimum of ____ reference from similar project completed within the past ____ years.

[Refer also to Instructions to Bidders for additional requirements, if any]

Ann Arbor ITB No. 4504

1) <u>RRFB Installation at Various Locations</u>	<u>\$301,008</u>	<u>10/15/2018</u>
Project Name	Cost	Date Constructed

<u>Brian Slizewski, PE</u>	<u>(734) 794-6410</u>
Contact Name	Phone Number

RCOC Project #972018 Countywide

2) <u>Traffic Signal Underground</u>	<u>\$210,471</u>	<u>12/18/2018</u>
Project Name	Cost	Date Constructed

<u>Steve Wheeler</u>	<u>(248) 858-4744</u>
Contact Name	Phone Number

GCRC 2017 Traffic

3) <u>Signal Modernization</u>	<u>\$187,991</u>	<u>5/3/2018</u>
Project Name	Cost	Date Constructed

<u>John Plamondon</u>	<u>(810) 767-4920</u>
Contact Name	Phone Number

BID FORM

Section 1 – Schedule of Prices

Company: _____

Project: 2019 RRFB Installations

File #: 2019-025 ITB No.: 4574

<u>Item</u>	<u>Description</u>	<u>Unit</u>	<u>Quantity</u>	<u>Unit Price</u>	<u>Total Price</u>
200	Certified Payroll Compliance And Reporting	L.S.	1	\$ _____	\$ _____
201	RRBB Installation, Type 2, on Green Road at Greenbrier Blvd	Each	2	\$ _____	\$ _____
202	RRBB Installation, Type 2, on Geddes Road east of Earhart Road	Each	2	\$ _____	\$ _____
203	RRBB Installation, Type 2 , on N. Maple Road near S. Circle	Each	2	\$ _____	\$ _____
204	RRBB Installation, Type 2 , on N. Maple Road between Pamela Ave and Sequoia Pkwy	Each	2	\$ _____	\$ _____
205	RRBB Installation, Type 2, on S. Maple Road, between Bens St and Russell St	Each	2	\$ _____	\$ _____
TOTAL BID \$					_____

BID FORM

Section 2 – Material, Equipment and Environmental Alternates

The Base Bid proposal price shall include materials and equipment selected from the designated items and manufacturers listed in the bidding documents. This is done to establish uniformity in bidding and to establish standards of quality for the items named.

If the Contractor wishes to quote alternate items for consideration by the City, it may do so under this Section. A complete description of the item and the proposed price differential must be provided. Unless approved at the time of award, substitutions where items are specifically named will be considered only as a negotiated change in Contract Sum.

If an environmental alternative is bid the City strongly encourages bidders to provide recent examples of product testing and previous successful use for the City to properly evaluate the environmental alternative. Testing data from independent accredited organizations are strongly preferred.

<u>Item Number</u>	<u>Description</u>	<u>Add/Deduct Amount</u>
--------------------	--------------------	--------------------------

If the Bidder does not suggest any material or equipment alternate, the Bidder **MUST** complete the following statement:

For the work outlined in this request for bid, the bidder does NOT propose any material or equipment alternate under the Contract.

Signature of Authorized Representative of Bidder _____ Date _____

BID FORM

Section 3 - Time Alternate

If the Bidder takes exception to the time stipulated in Article III of the Contract, Time of Completion, page C-2, it is requested to stipulate below its proposed time for performance of the work. Consideration will be given to time in evaluating bids.

If the Bidder does not suggest any time alternate, the Bidder **MUST** complete the following statement:

For the work outlined in this request for bid, the bidder does NOT propose any time alternate under the Contract.

Signature of Authorized Representative of Bidder _____ Date _____

BID FORM

Section 4 - Major Subcontractors

For purposes of this Contract, a Subcontractor is anyone (other than the Contractor) who performs work (other than or in addition to the furnishing of materials, plans or equipment) at or about the construction site, directly or indirectly for or on behalf of the Contractor (and whether or not in privity of Contract with the Contractor), but shall not include any individual who furnishes merely the individual's own personal labor or services.

Contractor agrees that all subcontracts entered into by the Contractor shall contain similar wage provision to Section 4 of the General Conditions covering subcontractor's employees who perform work on this contract.

For the work outlined in these documents the Bidder expects to engage the following major subcontractors to perform the work identified:

<u>Subcontractor (Name and Address)</u>	<u>Work</u>	<u>Amount</u>
---	-------------	---------------

If the Bidder does not expect to engage any major subcontractor, the Bidder **MUST** complete the following statement:

For the work outlined in this request for bid, the bidder does NOT expect to engage any major subcontractor to perform work under the Contract.

Signature of Authorized Representative of Bidder _____ Date _____

BID FORM

Section 5 – References

Include a minimum of ____ reference from similar project completed within the past ____ years.

[Refer also to Instructions to Bidders for additional requirements, if any]

1) _____
Project Name Cost Date Constructed

_____ _____
Contact Name Phone Number

2) _____
Project Name Cost Date Constructed

_____ _____
Contact Name Phone Number

3) _____
Project Name Cost Date Constructed

_____ _____
Contact Name Phone Number

CONTRACT

THIS AGREEMENT is made on the _____ day of _____, 2019, between the CITY OF ANN ARBOR, a Michigan Municipal Corporation, 301 East Huron Street, Ann Arbor, Michigan 48104 ("City") and J. Ranck Electric, Inc. ("Contractor"), a Michigan Corporation, whose address is 1993 Gover Parkway, Mt. Pleasant, MI 48858

Based upon the mutual promises below, the Contractor and the City agree as follows:

ARTICLE I - Scope of Work

The Contractor agrees to furnish all of the materials, equipment and labor necessary; and to abide by all the duties and responsibilities applicable to it for the project titled **2019 RRFB Installations, ITB No. 4574** in accordance with the requirements and provisions of the following documents, including all written modifications incorporated into any of the documents, which are incorporated as part of this Contract:

Non-discrimination and Living Wage Declaration of Compliance Forms (if applicable)	General Conditions
Vendor Conflict of Interest Form	Standard Specifications
Prevailing Wage Declaration of Compliance Form (if applicable)	Detailed Specifications
Bid Forms	Plans
Contract and Exhibits	Addenda
Bonds	

ARTICLE II - Definitions

Administering Service Area/Unit means Public **Services Area/Engineering Unit**

Project means **2019 RRFB Installations, ITB No. 4574**

ARTICLE III - Time of Completion

- (A) The work to be completed under this Contract shall begin immediately on the date specified in the Notice to Proceed issued by the City.
- (B) The work for this Contract shall be completed within the time specified in the Detailed Specification for Project Scheduling.
- (C) Failure to complete all the work within the time specified above, including any extension granted in writing by the Supervising Professional, shall obligate the Contractor to pay the City, as liquidated damages and not as a penalty, an amount equal to \$500 for each calendar day of delay in the completion of all the work. If any liquidated damages are unpaid by the Contractor, the City shall be entitled to deduct these unpaid liquidated damages from the monies due the Contractor.

The liquidated damages are for the non-quantifiable aspects of any of the previously identified events and do not cover actual damages that can be shown or quantified nor are they intended to preclude recovery of actual damages in

addition to the recovery of liquidated damages.

ARTICLE IV - The Contract Sum

- (A) The City shall pay to the Contractor for the performance of the Contract, the unit prices as given in the Bid Form for the estimated bid total of:
Ninety Five Thousand, Seven Hundred Fifty Dollars (\$95,750.00)
- (B) The amount paid shall be equitably adjusted to cover changes in the work ordered by the Supervising Professional but not required by the Contract Documents. Increases or decreases shall be determined only by written agreement between the City and Contractor.

ARTICLE V - Assignment

This Contract may not be assigned or subcontracted any portion of any right or obligation under this contract without the written consent of the City. Notwithstanding any consent by the City to any assignment, Contractor shall at all times remain bound to all warranties, certifications, indemnifications, promises and performances, however described, as are required of it under this contract unless specifically released from the requirement, in writing, by the City.

ARTICLE VI - Choice of Law

This Contract shall be construed, governed, and enforced in accordance with the laws of the State of Michigan. By executing this agreement, the Contractor and the City agree to venue in a court of appropriate jurisdiction sitting within Washtenaw County for purposes of any action arising under this Contract. The parties stipulate that the venue referenced in this Contract is for convenience and waive any claim of non-convenience.

Whenever possible, each provision of the Contract will be interpreted in a manner as to be effective and valid under applicable law. The prohibition or invalidity, under applicable law, of any provision will not invalidate the remainder of the Contract.

ARTICLE VII - Relationship of the Parties

The parties of the Contract agree that it is not a Contract of employment but is a Contract to accomplish a specific result. Contractor is an independent Contractor performing services for the City. Nothing contained in this Contract shall be deemed to constitute any other relationship between the City and the Contractor.

Contractor certifies that it has no personal or financial interest in the project other than the compensation it is to receive under the Contract. Contractor certifies that it is not, and shall not become, overdue or in default to the City for any Contract, debt, or any other obligation to the City including real or personal property taxes. City shall have the right to set off any such debt against compensation awarded for services under this agreement.

ARTICLE VIII - Notice

All notices given under this Contract shall be in writing, and shall be by personal delivery or by certified mail with return receipt requested to the parties at their respective addresses as specified in the Contract Documents or other address the Contractor may specify in writing. Notice will be deemed given on the date when one of the following first occur: (1) the date of actual receipt; or (2) three days after mailing certified U.S. mail.

ARTICLE IX - Indemnification

To the fullest extent permitted by law, Contractor shall indemnify, defend and hold harmless the City, its officers, employees and agents harmless from all suits, claims, judgments and expenses including attorney’s fees resulting or alleged to result, in whole or in part, from any act or omission, which is in any way connected or associated with this Contract, by the Contractor or anyone acting on the Contractor’s behalf under this Contract. Contractor shall not be responsible to indemnify the City for losses or damages caused by or resulting from the City’s sole negligence. The provisions of this Article shall survive the expiration or earlier termination of this contract for any reason.

ARTICLE X - Entire Agreement

This Contract represents the entire understanding between the City and the Contractor and it supersedes all prior representations, negotiations, agreements, or understandings whether written or oral. Neither party has relied on any prior representations in entering into this Contract. No terms or conditions of either party’s invoice, purchase order or other administrative document shall modify the terms and conditions of this Contract, regardless of the other party’s failure to object to such form. This Contract shall be binding on and shall inure to the benefit of the parties to this Contract and their permitted successors and permitted assigns and nothing in this Contract, express or implied, is intended to or shall confer on any other person or entity any legal or equitable right, benefit, or remedy of any nature whatsoever under or by reason of this Contract. This Contract may be altered, amended or modified only by written amendment signed by the City and the Contractor.

FOR CONTRACTOR

By _____

Its: _____

FOR THE CITY OF ANN ARBOR

By _____
Christopher Taylor, Mayor

By _____
Jacqueline Beaudry, City Clerk

Approved as to substance

By _____
Howard S. Lazarus
City Administrator

By _____
Craig Hupy
Public Services Area Administrator

Approved as to form and content

Stephen K. Postema, City Attorney

PERFORMANCE BOND

- (1) _____ of _____ (referred to as "Principal"), and _____, a corporation duly authorized to do business in the State of Michigan (referred to as "Surety"), are bound to the City of Ann Arbor, Michigan (referred to as "City"), for \$ _____, the payment of which Principal and Surety bind themselves, their heirs, executors, administrators, successors and assigns, jointly and severally, by this bond.
- (2) The Principal has entered a written Contract with the City dated _____, 201_, for: _____ and this bond is given for that Contract in compliance with Act No. 213 of the Michigan Public Acts of 1963, as amended, being MCL 129.201 et seq.
- (3) Whenever the Principal is declared by the City to be in default under the Contract, the Surety may promptly remedy the default or shall promptly:
- (a) complete the Contract in accordance with its terms and conditions; or
 - (b) obtain a bid or bids for submission to the City for completing the Contract in accordance with its terms and conditions, and upon determination by Surety of the lowest responsible bidder, arrange for a Contract between such bidder and the City, and make available, as work progresses, sufficient funds to pay the cost of completion less the balance of the Contract price; but not exceeding, including other costs and damages for which Surety may be liable hereunder, the amount set forth in paragraph 1.
- (4) Surety shall have no obligation to the City if the Principal fully and promptly performs under the Contract.
- (5) Surety agrees that no change, extension of time, alteration or addition to the terms of the Contract or to the work to be performed thereunder, or the specifications accompanying it shall in any way affect its obligations on this bond, and waives notice of any such change, extension of time, alteration or addition to the terms of the Contract or to the work, or to the specifications.

SIGNED AND SEALED this _____ day of _____, 201_.

(Name of Surety Company)
By _____
(Signature)
Its _____
(Title of Office)

(Name of Principal)
By _____
(Signature)
Its _____
(Title of Office)

Approved as to form:

Name and address of agent:

Stephen K. Postema, City Attorney

LABOR AND MATERIAL BOND

- (1) _____
of _____ (referred to as "Principal"), and _____, a corporation duly authorized to do business in the State of Michigan, (referred to as "Surety"), are bound to the City of Ann Arbor, Michigan (referred to as "City"), for the use and benefit of claimants as defined in Act 213 of Michigan Public Acts of 1963, as amended, being MCL 129.201 et seq., in the amount of \$ _____, for the payment of which Principal and Surety bind themselves, their heirs, executors, administrators, successors and assigns, jointly and severally, by this bond.
- (2) The Principal has entered a written Contract with the City, dated _____, 201_, for _____; and this bond is given for that Contract in compliance with Act No. 213 of the Michigan Public Acts of 1963 as amended;
- (3) If the Principal fails to promptly and fully repay claimants for labor and material reasonably required under the Contract, the Surety shall pay those claimants.
- (4) Surety's obligations shall not exceed the amount stated in paragraph 1, and Surety shall have no obligation if the Principal promptly and fully pays the claimants.

SIGNED AND SEALED this _____ day of _____, 201_

(Name of Surety Company)

By _____
(Signature)

Its _____
(Title of Office)

Approved as to form:

Stephen K. Postema, City Attorney

(Name of Principal)

By _____
(Signature)

Its _____
(Title of Office)

Name and address of agent:

GENERAL CONDITIONS

Section 1 - Execution, Correlation and Intent of Documents

The contract documents shall be signed in 2 copies by the City and the Contractor.

The contract documents are complementary and what is called for by any one shall be binding. The intention of the documents is to include all labor and materials, equipment and transportation necessary for the proper execution of the work. Materials or work described in words which so applied have a well-known technical or trade meaning have the meaning of those recognized standards.

In case of a conflict among the contract documents listed below in any requirement(s), the requirement(s) of the document listed first shall prevail over any conflicting requirement(s) of a document listed later.

(1) Addenda in reverse chronological order; (2) Detailed Specifications; (3) Standard Specifications; (4) Plans; (5) General Conditions; (6) Contract; (7) Bid Forms; (8) Bond Forms; (9) Bid.

Section 2 - Order of Completion

The Contractor shall submit with each invoice, and at other times reasonably requested by the Supervising Professional, schedules showing the order in which the Contractor proposes to carry on the work. They shall include the dates at which the Contractor will start the several parts of the work, the estimated dates of completion of the several parts, and important milestones within the several parts.

Section 3 - Familiarity with Work

The Bidder or its representative shall make personal investigations of the site of the work and of existing structures and shall determine to its own satisfaction the conditions to be encountered, the nature of the ground, the difficulties involved, and all other factors affecting the work proposed under this Contract. The Bidder to whom this Contract is awarded will not be entitled to any additional compensation unless conditions are clearly different from those which could reasonably have been anticipated by a person making diligent and thorough investigation of the site.

The Bidder shall immediately notify the City upon discovery, and in every case prior to submitting its Bid, of every error or omission in the bidding documents that would be identified by a reasonably competent, diligent Bidder. In no case will a Bidder be allowed the benefit of extra compensation or time to complete the work under this Contract for extra expenses or time spent as a result of the error or omission.

Section 4 - Wage Requirements

Under this Contract, the Contractor shall conform to Chapter 14 of Title I of the Code of the City of Ann Arbor as amended; which in part states "...that all craftsmen, mechanics and laborers employed directly on the site in connection with said improvements, including said employees of subcontractors, shall receive the prevailing wage for the corresponding classes of craftsmen,

mechanics and laborers, as determined by statistics for the Ann Arbor area compiled by the United States Department of Labor. At the request of the City, any contractor or subcontractor shall provide satisfactory proof of compliance with the contract provisions required by the Section.

Pursuant to Resolution R-16-469 all public improvement contractors are subject to prevailing wage and will be required to provide to the City payroll records sufficient to demonstrate compliance with the prevailing wage requirements. A sample Prevailing Wage Form is provided in the Appendix herein for reference as to what will be expected from contractors. Use of the Prevailing Wage Form provided in the Appendix section or a City-approved equivalent will be required along with wage rate interviews.

Where the Contract and the Ann Arbor City Ordinance are silent as to definitions of terms required in determining contract compliance with regard to prevailing wages, the definitions provided in the Davis-Bacon Act as amended (40 U.S.C. 278-a to 276-a-7) for the terms shall be used.

If the Contractor is a "covered employer" as defined in Chapter 23 of the Ann Arbor City Code, the Contractor agrees to comply with the living wage provisions of Chapter 23 of the Ann Arbor City Code. The Contractor agrees to pay those employees providing Services to the City under this Agreement a "living wage," as defined in Section 1:815 of the Ann Arbor City Code, as adjusted in accordance with Section 1:815(3); to post a notice approved by the City of the applicability of Chapter 23 in every location in which regular or contract employees providing services under this Agreement are working; to maintain records of compliance; if requested by the City, to provide documentation to verify compliance; to take no action that would reduce the compensation, wages, fringe benefits, or leave available to any employee or person contracted for employment in order to pay the living wage required by Section 1:815; and otherwise to comply with the requirements of Chapter 23.

Contractor agrees that all subcontracts entered into by the Contractor shall contain similar wage provision covering subcontractor's employees who perform work on this contract.

Section 5 - Non-Discrimination

The Contractor agrees to comply, and to require its subcontractor(s) to comply, with the nondiscrimination provisions of MCL 37.2209. The Contractor further agrees to comply with the provisions of Section 9:158 of Chapter 112 of Title IX of the Ann Arbor City Code, and to assure that applicants are employed and that employees are treated during employment in a manner which provides equal employment opportunity.

Section 6 - Materials, Appliances, Employees

Unless otherwise stipulated, the Contractor shall provide and pay for all materials, labor, water, tools, equipment, light, power, transportation, and other facilities necessary or used for the execution and completion of the work. Unless otherwise specified, all materials incorporated in the permanent work shall be new, and both workmanship and materials shall be of the highest quality. The Contractor shall, if required, furnish satisfactory evidence as to the kind and quality of materials.

The Contractor shall at all times enforce strict discipline and good order among its employees, and shall seek to avoid employing on the work any unfit person or anyone not skilled in the work assigned.

Adequate sanitary facilities shall be provided by the Contractor.

Section 7 - Qualifications for Employment

The Contractor shall employ competent laborers and mechanics for the work under this Contract. For work performed under this Contract, employment preference shall be given to qualified local residents.

Section 8 - Royalties and Patents

The Contractor shall pay all royalties and license fees. It shall defend all suits or claims for infringements of any patent rights and shall hold the City harmless from loss on account of infringement except that the City shall be responsible for all infringement loss when a particular process or the product of a particular manufacturer or manufacturers is specified, unless the City has notified the Contractor prior to the signing of the Contract that the particular process or product is patented or is believed to be patented.

Section 9 - Permits and Regulations

The Contractor must secure and pay for all permits, permit or plan review fees and licenses necessary for the prosecution of the work. These include but are not limited to City building permits, right-of-way permits, lane closure permits, right-of-way occupancy permits, and the like. The City shall secure and pay for easements shown on the plans unless otherwise specified.

The Contractor shall give all notices and comply with all laws, ordinances, rules and regulations bearing on the conduct of the work as drawn and specified. If the Contractor observes that the contract documents are at variance with those requirements, it shall promptly notify the Supervising Professional in writing, and any necessary changes shall be adjusted as provided in the Contract for changes in the work.

Section 10 - Protection of the Public and of Work and Property

The Contractor is responsible for the means, methods, sequences, techniques and procedures of construction and safety programs associated with the work contemplated by this contract. The Contractor, its agents or sub-contractors, shall comply with the "General Rules and Regulations for the Construction Industry" as published by the Construction Safety Commission of the State of Michigan and to all other local, State and National laws, ordinances, rules and regulations pertaining to safety of persons and property.

The Contractor shall take all necessary and reasonable precautions to protect the safety of the public. It shall continuously maintain adequate protection of all work from damage, and shall take all necessary and reasonable precautions to adequately protect all public and private property from injury or loss arising in connection with this Contract. It shall make good any damage, injury or loss to its work and to public and private property resulting from lack of reasonable protective precautions, except as may be due to errors in the contract documents, or caused by agents or employees of the City. The Contractor shall obtain and maintain sufficient insurance to cover damage to any City property at the site by any cause.

In an emergency affecting the safety of life, or the work, or of adjoining property, the Contractor is, without special instructions or authorization from the Supervising Professional, permitted to act at its discretion to prevent the threatened loss or injury. It shall also so act, without appeal, if authorized or instructed by the Supervising Professional.

Any compensation claimed by the Contractor for emergency work shall be determined by agreement or in accordance with the terms of Claims for Extra Cost - Section 15.

Section 11 - Inspection of Work

The City shall provide sufficient competent personnel for the inspection of the work.

The Supervising Professional shall at all times have access to the work whenever it is in preparation or progress, and the Contractor shall provide proper facilities for access and for inspection.

If the specifications, the Supervising Professional's instructions, laws, ordinances, or any public authority require any work to be specially tested or approved, the Contractor shall give the Supervising Professional timely notice of its readiness for inspection, and if the inspection is by an authority other than the Supervising Professional, of the date fixed for the inspection. Inspections by the Supervising Professional shall be made promptly, and where practicable at the source of supply. If any work should be covered up without approval or consent of the Supervising Professional, it must, if required by the Supervising Professional, be uncovered for examination and properly restored at the Contractor's expense.

Re-examination of any work may be ordered by the Supervising Professional, and, if so ordered, the work must be uncovered by the Contractor. If the work is found to be in accordance with the contract documents, the City shall pay the cost of re-examination and replacement. If the work is not in accordance with the contract documents, the Contractor shall pay the cost.

Section 12 - Superintendence

The Contractor shall keep on the work site, during its progress, a competent superintendent and any necessary assistants, all satisfactory to the Supervising Professional. The superintendent will be responsible to perform all on-site project management for the Contractor. The superintendent shall be experienced in the work required for this Contract. The superintendent shall represent the Contractor and all direction given to the superintendent shall be binding as if given to the Contractor. Important directions shall immediately be confirmed in writing to the Contractor. Other directions will be confirmed on written request. The Contractor shall give efficient superintendence to the work, using its best skill and attention.

Section 13 - Changes in the Work

The City may make changes to the quantities of work within the general scope of the Contract at any time by a written order and without notice to the sureties. If the changes add to or deduct from the extent of the work, the Contract Sum shall be adjusted accordingly. All the changes shall be executed under the conditions of the original Contract except that any claim for extension of time caused by the change shall be adjusted at the time of ordering the change.

In giving instructions, the Supervising Professional shall have authority to make minor changes in the work not involving extra cost and not inconsistent with the purposes of the work, but otherwise, except in an emergency endangering life or property, no extra work or change shall be made unless in pursuance of a written order by the Supervising Professional, and no claim for an addition to the Contract Sum shall be valid unless the additional work was ordered in writing.

The Contractor shall proceed with the work as changed and the value of the work shall be determined as provided in Claims for Extra Cost - Section 15.

Section 14 - Extension of Time

Extension of time stipulated in the Contract for completion of the work will be made if and as the

Supervising Professional may deem proper under any of the following circumstances:

- (1) When work under an extra work order is added to the work under this Contract;
- (2) When the work is suspended as provided in Section 20;
- (3) When the work of the Contractor is delayed on account of conditions which could not have been foreseen, or which were beyond the control of the Contractor, and which were not the result of its fault or negligence;
- (4) Delays in the progress of the work caused by any act or neglect of the City or of its employees or by other Contractors employed by the City;
- (5) Delay due to an act of Government;
- (6) Delay by the Supervising Professional in the furnishing of plans and necessary information;
- (7) Other cause which in the opinion of the Supervising Professional entitles the Contractor to an extension of time.

The Contractor shall notify the Supervising Professional within 7 days of an occurrence or conditions which, in the Contractor's opinion, entitle it to an extension of time. The notice shall be in writing and submitted in ample time to permit full investigation and evaluation of the Contractor's claim. The Supervising Professional shall acknowledge receipt of the Contractor's notice within 7 days of its receipt. Failure to timely provide the written notice shall constitute a waiver by the Contractor of any claim.

In situations where an extension of time in contract completion is appropriate under this or any other section of the contract, the Contractor understands and agrees that the only available adjustment for events that cause any delays in contract completion shall be extension of the required time for contract completion and that there shall be no adjustments in the money due the Contractor on account of the delay.

Section 15 - Claims for Extra Cost

If the Contractor claims that any instructions by drawings or other media issued after the date of the Contract involved extra cost under this Contract, it shall give the Supervising Professional written notice within 7 days after the receipt of the instructions, and in any event before proceeding to execute the work, except in emergency endangering life or property. The procedure shall then be as provided for Changes in the Work-Section 13. No claim shall be valid unless so made.

If the Supervising Professional orders, in writing, the performance of any work not covered by the contract documents, and for which no item of work is provided in the Contract, and for which no unit price or lump sum basis can be agreed upon, then the extra work shall be done on a Cost-Plus-Percentage basis of payment as follows:

- (1) The Contractor shall be reimbursed for all reasonable costs incurred in doing the work, and shall receive an additional payment of 15% of all the reasonable costs to cover both its indirect overhead costs and profit;
- (2) The term "Cost" shall cover all payroll charges for employees and supervision required under the specific order, together with all worker's compensation, Social Security, pension and retirement allowances and social insurance, or other regular payroll charges on same;

the cost of all material and supplies required of either temporary or permanent character; rental of all power-driven equipment at agreed upon rates, together with cost of fuel and supply charges for the equipment; and any costs incurred by the Contractor as a direct result of executing the order, if approved by the Supervising Professional;

- (3) If the extra is performed under subcontract, the subcontractor shall be allowed to compute its charges as described above. The Contractor shall be permitted to add an additional charge of 5% percent to that of the subcontractor for the Contractor's supervision and contractual responsibility;
- (4) The quantities and items of work done each day shall be submitted to the Supervising Professional in a satisfactory form on the succeeding day, and shall be approved by the Supervising Professional and the Contractor or adjusted at once;
- (5) Payments of all charges for work under this Section in any one month shall be made along with normal progress payments. Retainage shall be in accordance with Progress Payments-Section 16.

No additional compensation will be provided for additional equipment, materials, personnel, overtime or special charges required to perform the work within the time requirements of the Contract.

When extra work is required and no suitable price for machinery and equipment can be determined in accordance with this Section, the hourly rate paid shall be 1/40 of the basic weekly rate listed in the Rental Rate Blue Book published by Dataquest Incorporated and applicable to the time period the equipment was first used for the extra work. The hourly rate will be deemed to include all costs of operation such as bucket or blade, fuel, maintenance, "regional factors", insurance, taxes, and the like, but not the costs of the operator.

Section 16 - Progress Payments

The Contractor shall submit each month, or at longer intervals, if it so desires, an invoice covering work performed for which it believes payment, under the Contract terms, is due. The submission shall be to the City's Finance Department - Accounting Division. The Supervising Professional will, within 10 days following submission of the invoice, prepare a certificate for payment for the work in an amount to be determined by the Supervising Professional as fairly representing the acceptable work performed during the period covered by the Contractor's invoice. To insure the proper performance of this Contract, the City will retain a percentage of the estimate in accordance with Act 524, Public Acts of 1980. The City will then, following the receipt of the Supervising Professional's Certificate, make payment to the Contractor as soon as feasible, which is anticipated will be within 15 days.

An allowance may be made in progress payments if substantial quantities of permanent material have been delivered to the site but not incorporated in the completed work if the Contractor, in the opinion of the Supervising Professional, is diligently pursuing the work under this Contract. Such materials shall be properly stored and adequately protected. Allowance in the estimate shall be at the invoice price value of the items. Notwithstanding any payment of any allowance, all risk of loss due to vandalism or any damages to the stored materials remains with the Contractor.

In the case of Contracts which include only the Furnishing and Delivering of Equipment, the payments shall be; 60% of the Contract Sum upon the delivery of all equipment to be furnished, or in the case of delivery of a usable portion of the equipment in advance of the total equipment delivery, 60% of the estimated value of the portion of the equipment may be paid upon its delivery in advance of the time of the remainder of the equipment to be furnished; 30% of the Contract

Sum upon completion of erection of all equipment furnished, but not later than 60 days after the date of delivery of all of the equipment to be furnished; and payment of the final 10% on final completion of erection, testing and acceptance of all the equipment to be furnished; but not later than 180 days after the date of delivery of all of the equipment to be furnished, unless testing has been completed and shows the equipment to be unacceptable.

With each invoice for periodic payment, the Contractor shall enclose a Contractor's Declaration - Section 43, and an updated project schedule per Order of Completion - Section 2.

Section 17 - Deductions for Uncorrected Work

If the Supervising Professional decides it is inexpedient to correct work that has been damaged or that was not done in accordance with the Contract, an equitable deduction from the Contract price shall be made.

Section 18 - Correction of Work Before Final Payment

The Contractor shall promptly remove from the premises all materials condemned by the Supervising Professional as failing to meet Contract requirements, whether incorporated in the work or not, and the Contractor shall promptly replace and re-execute the work in accordance with the Contract and without expense to the City and shall bear the expense of making good all work of other contractors destroyed or damaged by the removal or replacement.

If the Contractor does not remove the condemned work and materials within 10 days after written notice, the City may remove them and, if the removed material has value, may store the material at the expense of the Contractor. If the Contractor does not pay the expense of the removal within 10 days thereafter, the City may, upon 10 days written notice, sell the removed materials at auction or private sale and shall pay to the Contractor the net proceeds, after deducting all costs and expenses that should have been borne by the Contractor. If the removed material has no value, the Contractor must pay the City the expenses for disposal within 10 days of invoice for the disposal costs.

The inspection or lack of inspection of any material or work pertaining to this Contract shall not relieve the Contractor of its obligation to fulfill this Contract and defective work shall be made good. Unsuitable materials may be rejected by the Supervising Professional notwithstanding that the work and materials have been previously overlooked by the Supervising Professional and accepted or estimated for payment or paid for. If the work or any part shall be found defective at any time before the final acceptance of the whole work, the Contractor shall forthwith make good the defect in a manner satisfactory to the Supervising Professional. The judgment and the decision of the Supervising Professional as to whether the materials supplied and the work done under this Contract comply with the requirements of the Contract shall be conclusive and final.

Section 19 - Acceptance and Final Payment

Upon receipt of written notice that the work is ready for final inspection and acceptance, the Supervising Professional will promptly make the inspection. When the Supervising Professional finds the work acceptable under the Contract and the Contract fully performed, the Supervising Professional will promptly sign and issue a final certificate stating that the work required by this Contract has been completed and is accepted by the City under the terms and conditions of the Contract. The entire balance found to be due the Contractor, including the retained percentage, shall be paid to the Contractor by the City within 30 days after the date of the final certificate.

Before issuance of final certificates, the Contractor shall file with the City:

- (1) The consent of the surety to payment of the final estimate;
- (2) The Contractor's Affidavit in the form required by Section 44.

In case the Affidavit or consent is not furnished, the City may retain out of any amount due the Contractor, sums sufficient to cover all lienable claims.

The making and acceptance of the final payment shall constitute a waiver of all claims by the City except those arising from:

- (1) unsettled liens;
- (2) faulty work appearing within 12 months after final payment;
- (3) hidden defects in meeting the requirements of the plans and specifications;
- (4) manufacturer's guarantees.

It shall also constitute a waiver of all claims by the Contractor, except those previously made and still unsettled.

Section 20 - Suspension of Work

The City may at any time suspend the work, or any part by giving 5 days notice to the Contractor in writing. The work shall be resumed by the Contractor within 10 days after the date fixed in the written notice from the City to the Contractor to do so. The City shall reimburse the Contractor for expense incurred by the Contractor in connection with the work under this Contract as a result of the suspension.

If the work, or any part, shall be stopped by the notice in writing, and if the City does not give notice in writing to the Contractor to resume work at a date within 90 days of the date fixed in the written notice to suspend, then the Contractor may abandon that portion of the work suspended and will be entitled to the estimates and payments for all work done on the portions abandoned, if any, plus 10% of the value of the work abandoned, to compensate for loss of overhead, plant expense, and anticipated profit.

Section 21 - Delays and the City's Right to Terminate Contract

If the Contractor refuses or fails to prosecute the work, or any separate part of it, with the diligence required to insure completion, ready for operation, within the allowable number of consecutive calendar days specified plus extensions, or fails to complete the work within the required time, the City may, by written notice to the Contractor, terminate its right to proceed with the work or any part of the work as to which there has been delay. After providing the notice the City may take over the work and prosecute it to completion, by contract or otherwise, and the Contractor and its sureties shall be liable to the City for any excess cost to the City. If the Contractor's right to proceed is terminated, the City may take possession of and utilize in completing the work, any materials, appliances and plant as may be on the site of the work and useful for completing the work. The right of the Contractor to proceed shall not be terminated or the Contractor charged with liquidated damages where an extension of time is granted under Extension of Time - Section 14.

If the Contractor is adjudged a bankrupt, or if it makes a general assignment for the benefit of creditors, or if a receiver is appointed on account of its insolvency, or if it persistently or repeatedly refuses or fails except in cases for which extension of time is provided, to supply enough properly skilled workers or proper materials, or if it fails to make prompt payments to subcontractors or for material or labor, or persistently disregards laws, ordinances or the instructions of the Supervising Professional, or otherwise is guilty of a substantial violation of any provision of the Contract, then the City, upon the certificate of the Supervising Professional that sufficient cause exists to justify

such action, may, without prejudice to any other right or remedy and after giving the Contractor 3 days written notice, terminate this Contract. The City may then take possession of the premises and of all materials, tools and appliances thereon and without prejudice to any other remedy it may have, make good the deficiencies or finish the work by whatever method it may deem expedient, and deduct the cost from the payment due the Contractor. The Contractor shall not be entitled to receive any further payment until the work is finished. If the expense of finishing the work, including compensation for additional managerial and administrative services exceeds the unpaid balance of the Contract Sum, the Contractor and its surety are liable to the City for any excess cost incurred. The expense incurred by the City, and the damage incurred through the Contractor's default, shall be certified by the Supervising Professional.

Section 22 - Contractor's Right to Terminate Contract

If the work should be stopped under an order of any court, or other public authority, for a period of 3 months, through no act or fault of the Contractor or of anyone employed by it, then the Contractor may, upon 7 days written notice to the City, terminate this Contract and recover from the City payment for all acceptable work executed plus reasonable profit.

Section 23 - City's Right To Do Work

If the Contractor should neglect to prosecute the work properly or fail to perform any provision of this Contract, the City, 3 days after giving written notice to the Contractor and its surety may, without prejudice to any other remedy the City may have, make good the deficiencies and may deduct the cost from the payment due to the Contractor.

Section 24 - Removal of Equipment and Supplies

In case of termination of this Contract before completion, from any or no cause, the Contractor, if notified to do so by the City, shall promptly remove any part or all of its equipment and supplies from the property of the City, failing which the City shall have the right to remove the equipment and supplies at the expense of the Contractor.

The removed equipment and supplies may be stored by the City and, if all costs of removal and storage are not paid by the Contractor within 10 days of invoicing, the City upon 10 days written notice may sell the equipment and supplies at auction or private sale, and shall pay the Contractor the net proceeds after deducting all costs and expenses that should have been borne by the Contractor and after deducting all amounts claimed due by any lien holder of the equipment or supplies.

Section 25 - Responsibility for Work and Warranties

The Contractor assumes full responsibility for any and all materials and equipment used in the construction of the work and may not make claims against the City for damages to materials and equipment from any cause except negligence or willful act of the City. Until its final acceptance, the Contractor shall be responsible for damage to or destruction of the project (except for any part covered by Partial Completion and Acceptance - Section 26). The Contractor shall make good all work damaged or destroyed before acceptance. All risk of loss remains with the Contractor until final acceptance of the work (Section 19) or partial acceptance (Section 26). The Contractor is advised to investigate obtaining its own builders risk insurance.

The Contractor shall guarantee the quality of the work for a period of one year. The Contractor shall also unconditionally guarantee the quality of all equipment and materials that are furnished and installed under the contract for a period of one year. At the end of one year after the Contractor's receipt of final payment, the complete work, including equipment and materials

furnished and installed under the contract, shall be inspected by the Contractor and the Supervising Professional. Any defects shall be corrected by the Contractor at its expense as soon as practicable but in all cases within 60 days. Any defects that are identified prior to the end of one year shall also be inspected by the Contractor and the Supervising Professional and shall be corrected by the Contractor at its expense as soon as practicable but in all cases within 60 days. The Contractor shall assign all manufacturer or material supplier warranties to the City prior to final payment. The assignment shall not relieve the Contractor of its obligations under this paragraph to correct defects.

Section 26 - Partial Completion and Acceptance

If at any time prior to the issuance of the final certificate referred to in Acceptance and Final Payment - Section 19, any portion of the permanent construction has been satisfactorily completed, and if the Supervising Professional determines that portion of the permanent construction is not required for the operations of the Contractor but is needed by the City, the Supervising Professional shall issue to the Contractor a certificate of partial completion, and immediately the City may take over and use the portion of the permanent construction described in the certificate, and exclude the Contractor from that portion.

The issuance of a certificate of partial completion shall not constitute an extension of the Contractor's time to complete the portion of the permanent construction to which it relates if the Contractor has failed to complete it in accordance with the terms of this Contract. The issuance of the certificate shall not release the Contractor or its sureties from any obligations under this Contract including bonds.

If prior use increases the cost of, or delays the work, the Contractor shall be entitled to extra compensation, or extension of time, or both, as the Supervising Professional may determine.

Section 27 - Payments Withheld Prior to Final Acceptance of Work

The City may withhold or, on account of subsequently discovered evidence, nullify the whole or part of any certificate to the extent reasonably appropriate to protect the City from loss on account of:

- (1) Defective work not remedied;
- (2) Claims filed or reasonable evidence indicating probable filing of claims by other parties against the Contractor;
- (3) Failure of the Contractor to make payments properly to subcontractors or for material or labor;
- (4) Damage to another Contractor.

When the above grounds are removed or the Contractor provides a Surety Bond satisfactory to the City which will protect the City in the amount withheld, payment shall be made for amounts withheld under this section.

Section 28 - Contractor's Insurance

- (1) The Contractor shall procure and maintain during the life of this Contract, including the guarantee period and during any warranty work, such insurance policies, including those set forth below, as will protect itself and the City from all claims for bodily injuries, death

or property damage which may arise under this Contract; whether the act(s) or omission(s) giving rise to the claim were made by the Contractor or by any subcontractor or anyone employed by them directly or indirectly. In the case of all contracts involving on-site work, the Contractor shall provide to the City, before the commencement of any work under this contract, certificates of insurance and other documentation satisfactory to the City demonstrating it has obtained the policies and endorsements required on behalf of itself, and when requested, any subcontractor(s). The certificates of insurance endorsements and/or copies of policy language shall document that the Contractor satisfies the following minimum requirements.

- (a) Worker's Compensation Insurance in accordance with all applicable state and federal statutes. Further, Employers Liability Coverage shall be obtained in the following minimum amounts:

Bodily Injury by Accident - \$500,000 each accident
Bodily Injury by Disease - \$500,000 each employee
Bodily Injury by Disease - \$500,000 each policy limit

- (b) Commercial General Liability Insurance equivalent to, as a minimum, Insurance Services Office form CG 00 01 07 98 or current equivalent. The City of Ann Arbor shall be named as an additional insured. There shall be no added exclusions or limiting endorsements specifically for the following coverages: Products and Completed Operations, Explosion, Collapse and Underground coverage or Pollution. Further there shall be no added exclusions or limiting endorsements which diminish the City's protections as an additional insured under the policy. The following minimum limits of liability are required:

\$1,000,000 Each occurrence as respect Bodily Injury Liability or Property
Damage Liability, or both combined.
\$2,000,000 Per Job General Aggregate
\$1,000,000 Personal and Advertising Injury
\$2,000,000 Products and Completed Operations Aggregate

- (c) Motor Vehicle Liability Insurance, including Michigan No-Fault Coverages, equivalent to, as a minimum, Insurance Services Office form CA 00 01 07 97 or current equivalent. Coverage shall include all owned vehicles, all non-owned vehicles and all hired vehicles. The City of Ann Arbor shall be named as an additional insured. There shall be no added exclusions or limiting endorsements which diminish the City's protections as an additional insured under the policy. Further, the limits of liability shall be \$1,000,000 for each occurrence as respects Bodily Injury Liability or Property Damage Liability, or both combined.

- (d) Umbrella/Excess Liability Insurance shall be provided to apply excess of the Commercial General Liability, Employers Liability and the Motor Vehicle coverage enumerated above, for each occurrence and for aggregate in the amount of \$1,000,000.

- (2) Insurance required under subsection (1)(b) and (1)(c) above shall be considered primary as respects any other valid or collectible insurance that the City may possess, including any self-insured retentions the City may have; and any other insurance the City does possess shall be considered excess insurance only and shall not be required to contribute with this insurance. Further, the Contractor agrees to waive any right of recovery by its insurer against the City.

- (3) Insurance companies and policy forms are subject to approval of the City Attorney, which

approval shall not be unreasonably withheld. Documentation must provide and demonstrate an unconditional 30 day written notice of cancellation in favor of the City of Ann Arbor. Further, the documentation must explicitly state the following: (a) the policy number; name of insurance company; name and address of the agent or authorized representative; name and address of insured; project name; policy expiration date; and specific coverage amounts; (b) any deductibles or self-insured retentions which shall be approved by the City, in its sole discretion; (c) that the policy conforms to the requirements specified Contractor shall furnish the City with satisfactory certificates of insurance and endorsements prior to commencement of any work. Upon request, the Contractor shall provide within 30 days a copy of the policy(ies) to the City. If any of the above coverages expire by their terms during the term of this Contract, the Contractor shall deliver proof of renewal and/or new policies and endorsements to the Administering Service Area/Unit at least ten days prior to the expiration date.

- (4) Any Insurance provider of Contractor shall be admitted and authorized to do business in the State of Michigan and shall carry and maintain a minimum rating assigned by A.M. Best & Company's Key Rating Guide of "A-" Overall and a minimum Financial Size Category of "V". Insurance policies and certificates issued by non-admitted insurance companies are not acceptable unless approved in writing by the City.
- (5) City reserves the right to require additional coverage and/or coverage amounts as may be included from time to time in the Detailed Specifications for the Project.
- (6) The provisions of General Condition 28 shall survive the expiration or earlier termination of this contract for any reason.

Section 29 - Surety Bonds

Bonds will be required from the successful bidder as follows:

- (1) A Performance Bond to the City of Ann Arbor for the amount of the bid(s) accepted;
- (2) A Labor and Material Bond to the City of Ann Arbor for the amount of the bid(s) accepted.

Bonds shall be executed on forms supplied by the City in a manner and by a Surety Company authorized to transact business in Michigan and satisfactory to the City Attorney.

Section 30 - Damage Claims

The Contractor shall be held responsible for all damages to property of the City or others, caused by or resulting from the negligence of the Contractor, its employees, or agents during the progress of or connected with the prosecution of the work, whether within the limits of the work or elsewhere. The Contractor must restore all property injured including sidewalks, curbing, sodding, pipes, conduit, sewers or other public or private property to not less than its original condition with new work.

Section 31 - Refusal to Obey Instructions

If the Contractor refuses to obey the instructions of the Supervising Professional, the Supervising Professional shall withdraw inspection from the work, and no payments will be made for work performed thereafter nor may work be performed thereafter until the Supervising Professional shall have again authorized the work to proceed.

Section 32 - Assignment

Neither party to the Contract shall assign the Contract without the written consent of the other. The Contractor may assign any monies due to it to a third party acceptable to the City.

Section 33 - Rights of Various Interests

Whenever work being done by the City's forces or by other contractors is contiguous to work covered by this Contract, the respective rights of the various interests involved shall be established by the Supervising Professional, to secure the completion of the various portions of the work in general harmony.

The Contractor is responsible to coordinate all aspects of the work, including coordination of, and with, utility companies and other contractors whose work impacts this project.

Section 34 - Subcontracts

The Contractor shall not award any work to any subcontractor without prior written approval of the City. The approval will not be given until the Contractor submits to the City a written statement concerning the proposed award to the subcontractor. The statement shall contain all information the City may require.

The Contractor shall be as fully responsible to the City for the acts and omissions of its subcontractors, and of persons either directly or indirectly employed by them, as it is for the acts and omissions of persons directly employed by it.

The Contractor shall cause appropriate provisions to be inserted in all subcontracts relative to the work to bind subcontractors to the Contractor by the terms of the General Conditions and all other contract documents applicable to the work of the subcontractors and to give the Contractor the same power to terminate any subcontract that the City may exercise over the Contractor under any provision of the contract documents.

Nothing contained in the contract documents shall create any contractual relation between any subcontractor and the City.

Section 35 - Supervising Professional's Status

The Supervising Professional has the right to inspect any or all work. The Supervising Professional has authority to stop the work whenever stoppage may be appropriate to insure the proper execution of the Contract. The Supervising Professional has the authority to reject all work and materials which do not conform to the Contract and to decide questions which arise in the execution of the work.

The Supervising Professional shall make all measurements and determinations of quantities. Those measurements and determinations are final and conclusive between the parties.

Section 36 - Supervising Professional's Decisions

The Supervising Professional shall, within a reasonable time after their presentation to the Supervising Professional, make decisions in writing on all claims of the City or the Contractor and on all other matters relating to the execution and progress of the work or the interpretation of the contract documents.

Section 37 - Storing Materials and Supplies

Materials and supplies may be stored at the site of the work at locations agreeable to the City unless specific exception is listed elsewhere in these documents. Ample way for foot traffic and drainage must be provided, and gutters must, at all times, be kept free from obstruction. Traffic on streets shall be interfered with as little as possible. The Contractor may not enter or occupy with agents, employees, tools, or material any private property without first obtaining written permission from its owner. A copy of the permission shall be furnished to the Supervising Professional.

Section 38 - Lands for Work

The Contractor shall provide, at its own expense and without liability to the City, any additional land and access that may be required for temporary construction facilities or for storage of materials.

Section 39 - Cleaning Up

The Contractor shall, as directed by the Supervising Professional, remove at its own expense from the City's property and from all public and private property all temporary structures, rubbish and waste materials resulting from its operations unless otherwise specifically approved, in writing, by the Supervising Professional.

Section 40 - Salvage

The Supervising Professional may designate for salvage any materials from existing structures or underground services. Materials so designated remain City property and shall be transported or stored at a location as the Supervising Professional may direct.

Section 41 - Night, Saturday or Sunday Work

No night or Sunday work (without prior written City approval) will be permitted except in the case of an emergency and then only to the extent absolutely necessary. The City may allow night work which, in the opinion of the Supervising Professional, can be satisfactorily performed at night. Night work is any work between 8:00 p.m. and 7:00 a.m. No Saturday work will be permitted unless the Contractor gives the Supervising Professional at least 48 hours but not more than 5 days notice of the Contractor's intention to work the upcoming Saturday.

Section 42 - Sales Taxes

Under State law the City is exempt from the assessment of State Sales Tax on its direct purchases. Contractors who acquire materials, equipment, supplies, etc. for incorporation in City projects are not likewise exempt. State Law shall prevail. The Bidder shall familiarize itself with the State Law and prepare its Bid accordingly. No extra payment will be allowed under this Contract for failure of the Contractor to make proper allowance in this bid for taxes it must pay.

Section 43

CONTRACTOR'S DECLARATION

I hereby declare that I have not, during the period _____, 20____, to _____, 20____, performed any work, furnished any materials, sustained any loss, damage or delay, or otherwise done anything in addition to the regular items (or executed change orders) set forth in the Contract titled _____, for which I shall ask, demand, sue for, or claim compensation or extension of time from the City, except as I hereby make claim for additional compensation or extension of time as set forth on the attached itemized statement. I further declare that I have paid all payroll obligations related to this Contract that have become due during the above period and that all invoices related to this Contract received more than 30 days prior to this declaration have been paid in full except as listed below.

There is/is not (Contractor please circle one and strike one as appropriate) an itemized statement attached regarding a request for additional compensation or extension of time.

Contractor

Date

By _____
(Signature)

Its _____
(Title of Office)

Past due invoices, if any, are listed below.

STANDARD SPECIFICATIONS

All work under this contract shall be performed in accordance with the Public Services Department Standard Specifications in effect at the date of availability of the contract documents stipulated in the Bid. All work under this Contract which is not included in these Standard Specifications, or which is performed using modifications to these Standard Specifications, shall be performed in accordance with the Detailed Specifications included in these contract documents.

Standard Specifications are available online:

<http://www.a2gov.org/departments/engineering/Pages/Engineering-and-Contractor-Resources.aspx>

**DETAILED SPECIFICATION
FOR
ITEMS #201 thru #205 – RRFB INSTALLATION, TYPE SPECIFIED**

- a. Description.** This work consists of furnishing and installing wireless solar-powered, Rectangular Rapid Flashing Beacon (RRFB) assemblies at the locations shown in the plans. Each RRFB assembly includes lightbar(s), solar panel(s), battery(s), controller enclosure, control circuit, on-board user interface, wireless communication, pedestal, pole, pushbutton, signs, stainless steel mounting hardware, and all associated material required to complete the work. RRFBs shall be bi-directional (two-sided) unless otherwise specified on the plans. RRRB units, circuits, and controller enclosure shall be Carmanah SC315-G, or engineer approved equal.
- b. Materials.** Provide materials conforming to Buy America provisions and in accordance with sections 918 and 921 of the Standard Specifications for Construction and the following requirements of this special provision:
1. Controller Enclosure
 - A. Construction shall be NEMA 3R aluminum housing with lockable tamperproof hinged door.
 - B. Solar batteries, on-board user interface, and wireless communications shall be housed within the enclosure.
 2. On-board User Interface (OBUI)
 - A. The OBUI shall have an adjustable auto-scrolling LED display, and include the following selectable features:
 - i. Flash duration, adjustable from 10 – 60 seconds, in one-second increments
 - ii. Ambient auto-adjust
 - iii. Night time dimming
 - iv. Update configuration settings to other units in the system.
 - v. Channel Selection
 - vi. System test, status, and fault detection
 - vii. Activation data reporting
 3. Lightbar. Provide materials meeting the following requirements:
 - A. Lightbar housing must be black powder-coated aluminum, measuring 24” x 4.5” x 1.5”
 - B. A lightbar shall consist of two forward-facing primary beacons:
 - i. Each beacon must have an array of eight amber LEDs, each array measuring 7” x 3”
 - ii. Beacons must meet SAE J595 Class 1 intensity, and SAE J578 chromaticity
 - iii. LEDs must meet 90% lumen maintenance (L90) based on IES LM-80
 - C. The lightbar must include side-mounted pedestrian amber LED beacons which flash concurrently with the primary beacons.
 - D. The mounting assembly shall allow the lightbars to pivot 40 degrees horizontally in order to aim the lightbar independent of the wire hole location on the pole.
 - E. A bi-directional RRFB shall consist of two lightbars mounted back to back, which can pivot independently from each other.

- F. The lightbar assembly shall open for access to the wiring connections for the LED modules. LED modules shall be rated to MIL-STD-810F, Method 506.4 for ingress protection.
- 4. Beacon operation. Provide beacon operation meeting the following requirements:
 - A. The RRFB is dark until pedestrian actuation.
 - B. Initiate operation upon pedestrian actuation and cease operation at a predetermined time after actuation. Set this predetermined duration of operation as indicated in the plans or as determined by the Engineer.
 - C. Simultaneously begin (upon actuation) and end (after the predetermined duration) the operation of all RRFB's associated with a given crosswalk within 150 milliseconds of activation.
 - 5. Solar/battery system. Provide solar power system meeting the following requirements:
 - A. Underwriters Laboratories Incorporated (UL) approved solar panel, solar engine, and battery system. Solar panel and battery system sized for use north of the 40th parallel, including the state of Michigan.
 - B. The system shall include one 50-watt solar panel supplied with mounting hardware. The controller enclosure shall house one 35 Ah sealed valve-regulated lead-acid battery. The battery shall be readily available from multiple suppliers and non-proprietary. Solar panel and battery system shall be 12 Volt DC (nominal).
 - 6. Pushbutton and Signs
 - A. The pushbutton housing shall be cast aluminum with a yellow powder coat finish, with watertight o-ring seals. The housings shall be a minimum 14"H, 5 ½"W, 2 ½"D and contain the sign, arrow, speaker and LED's.
 - B. The pushbuttons shall be provided with a two inch diameter adjustable arrow indication to indicate the direction of travel.
 - C. The signs shall include the following:
 - i. One pushbutton housing sign, "Push Button to Turn on Warning Lights".
 - ii. Two W11-2, measuring 36" x 36".
 - iii. One W16-7PL, measuring 24" x 12".
 - iv. One W16-7PR, measuring 24" x 12".
 - D. The pushbuttons shall be provided with an audible voice message. The message shall be repeatable while the crosswalk lights are active. The pushbuttons shall be provided with a standard message "Cross street with caution, vehicles may not stop" or a custom message as required by the engineer.
 - E. Each pushbutton shall be provided with a locating tone with a selectable repeat rate. The locating tone and message shall be capable of having maximum and minimum limits set.
 - F. Each pushbutton shall be provided with an automatic volume adjustment to compensate for changes in ambient noise levels.
 - G. The pushbutton shall come complete with the sign, mounting hardware and control unit for mounting on the pedestal and pole.
 - 7. Pedestals and Poles (Type 1 and Type 2 installations).
 - A. Pedestal bases shall aluminum square conforming to the following specifications. Bases shall accommodate bolt circles from 12 inches to 14 ½ inches. The bases shall be designed to accommodate (4) four anchor bolts from 5/8 inch to 1 inch in diameter. There shall be slots in the bottom of each base to allow adjustment for anchor bolt placement.

- B. The bases shall be fabricated from aluminum, nominally 15 inches tall by 14 inches square. The bases shall be provided with an accessible hand-hole opening and a cast aluminum door with one stainless steel set screw. The collar of the base shall be provided with a stainless steel hex head bolt.
- C. Poles shall consist of 6061-T6 aluminum alloy, poles textured for a uniform rough grain pattern that is perpendicular to the axis of the pole for the full length of the pole. The poles shall have a length of 14-feet, wall thickness of .237 inches, and an O.D. of 4.5 inches. The poles shall be provided with four inches of NPT (National Standard Taper Pipe Thread).
- D. The threaded end of the poles shall have a protective cap installed to prevent thread damage. A cardboard sleeve shall cover the entire length of the shaft to protect the surface finish during shipment.

9. Pole and Mast Arm (Type 3 installation).

- A. Shaft pole and mast arm shall be constructed of 11-gauge galvanized steel, with 0.14 inch per foot taper, and conforming to ASTM A595 and ASTM A123. The tapered shaft shall be longitudinally cold rolled to flatten the weld and achieve a minimum yield strength of 55,000 psi.
- B. Galvanized 11-gauge steel shaft pole 15-inch diameter at base, with 0.14 inch per foot taper, 29-feet in length unless otherwise specified, conforming to ASTM A595 and ASTM A123. The shaft shall be formed from one length of steel sheet with no intermediate horizontal welds or joints. The tapered shaft shall be longitudinally cold rolled to flatten the weld and achieve a minimum yield strength of 55,000 psi. The pole base shall accommodate four 1-3/4" diameter anchor bolts in a 24-inch bolt circle.
- C. A 27" x 6" gasketed terminal compartment cover and 4" x 6" handhole cover shall be provided in the base of the pole.
- D. Galvanized 11-gauge steel mast arm 8-inch diameter at base, with 0.14 inch per foot taper, 25-feet in length unless otherwise specified, conforming to ASTM A595 and ASTM A123. The shaft shall be formed from one length of steel sheet with no intermediate horizontal welds or joints. The tapered shaft shall be longitudinally cold rolled to flatten the weld and achieve a minimum yield strength of 55,000 psi.
- E. The mast arm connection shall be with a steel flange measuring 22" H x 14-1/2" W and four 1-1/4" diameter bolts, providing a 3 percent rise of the mast arm, and a 4" x 6" handhole opposite the mast arm.

10. Warranty. Provide a manufacturer's warranty, transferable to City of Ann Arbor, that the supplied materials are free from all defects in material and workmanship. Furnish the warranty, other applicable documents from the manufacturer, and a copy of the invoice showing date of shipment to the Engineer prior to acceptance.

c. Construction. Complete this work in accordance with sections 819, 820, and 919 of the 2012 MDOT Standard Specifications for Construction, as shown the plans, and per this special provision.

- 1. Obtain shop drawing approval from the Engineer prior to installation of units.
- 2. Set the predetermined duration of operation of the RRFBs as indicated in the plans or as specified by the Engineer.
- 3. Mount the RRFB assemblies per manufacturer's requirements and as specified, in locations directed by the Engineer.

d. **Measurement and Payment.** The completed work, as described, will be measured and paid for at the contract unit price for the following pay item:

Pay Item

Pay Unit

Rectangular Rapid Flashing Beacon Assembly (Type specified)Each

Rectangular Rapid Flashing Beacon Assembly includes all labor, equipment, and materials required to furnish and install a new Rectangular Rapid Flashing Beacon as specified herein.

**DETAILED SPECIFICATION
FOR
ITEM #200 - CERTIFIED PAYROLL COMPLIANCE AND REPORTING**

- a. Description.** This specification covers all administrative requirements, payroll reporting procedures to be followed by Contractors performing work on City-sponsored public improvements projects, and all other miscellaneous and incidental costs associated with complying with the applicable sections of the City of Ann Arbor Code of Ordinances with regard to payment of prevailing wages and its Prevailing Wage Compliance policy.

This specification is **not** intended to include the actual labor costs associated with the payment of prevailing wages as required. Those costs should be properly incorporated in all other items of work bid.

- b. General.** The Contractor is expected to comply with all applicable sections of Federal and State prevailing wage laws, duly promulgated regulations, the City of Ann Arbor Code of Ordinances, and its Prevailing Wage Compliance Policy as defined within the contract documents. The Contractor shall provide the required certified payrolls, city-required declarations, and reports requested elsewhere in the contract documents within the timeline(s) stipulated therein.

The Contractor shall also provide corrected copies of any submitted documents that are found to contain errors, omissions, inconsistencies, or other defects that render the report invalid. The corrected copies shall be provided when requested by the Supervising Professional.

The Contractor shall also attend any required meetings as needed to fully discuss and ensure compliance with the contract requirements regarding prevailing wage compliance. The Contractor shall require all employees engaged in on-site work to participate in, provide the requested information to the extent practicable, and cooperate in the interview process. The City of Ann Arbor will provide the needed language interpreters in order to perform wage rate interviews or other field investigations as needed.

Certified Payrolls may be submitted on City-provided forms or forms used by the Contractor, as long as the Contractor's forms contain all required payroll information. If the Contractor elects to provide their own forms, the forms shall be approved by the Supervising Professional prior to the beginning of on-site work.

- c. Unbalanced Bidding.** The City of Ann Arbor will examine the submitted cost for this item of work prior to contract award. If the City determines, in its sole discretion, that the costs bid by the Contractor for complying with the contract requirements are not reasonable, accurately reported, or may contain discrepancies, the City reserves the right to request additional documentation that fully supports and justifies the price as bid. Should the submitted information not be determined to be reasonable or justify the costs, the City reserves the right to reject the bid.

The Contract Completion date will not be extended as a result of the City's investigation of the as-bid amount for this item of work, even if the anticipated contract award date must be adjusted. The only exception will be if the Contractor adequately demonstrates that their costs were appropriate and justifiable. If so, the City will adjust the contract completion date by the number of calendar days commensurate with the length of the investigation, if the published Notice to Proceed date of the work cannot be met. The contract unit prices for all other items of work will not be adjusted regardless of an adjustment of the contract completion date being made.

- d. **Measurement and Payment.** The completed work as measured for this item of work will be paid for at the Contract Unit Price for the following Contract (Pay) Item:

<u>Contract Item (Pay Item)</u>	<u>Pay Unit</u>
Certified Payroll Compliance and Reporting	Lump Sum

The unit price for this item of work shall include all supervisory, accounting, administrative, and equipment costs needed to monitor and perform all work related to maintaining compliance with the tasks specified in this Detailed Specification, the City of Ann Arbor Code of Ordinances, its Prevailing Wage Compliance policy and the applicable Federal and State laws.

Payment for this work will be made with each progress payment, on a pro-rata basis, based on the percentage of construction completed. When all of the work of this contract has been completed, the measurement of this item shall be 1.0 times the Lump Sum bid amount. This amount will not be increased for any reason, including extensions of time, extra work, and/or adjustments to existing items of work.

**DETAILED SPECIFICATION
FOR
PROJECT SCHEDULING**

The Contractor shall order materials on this Contract within three working days of the receipt of the Notice to Proceed, and provide evidence of the order to the Engineer. RRFB units shall be delivered to the Contractor for assembly and programming. A copy of the receipt of materials from the manufacturer shall be provided to the Engineer. The Contractor shall provide the Engineer with schedule of installation dated at each location for review and approval.

The City will complete concrete work, including RRFB foundations with bolts assemblies, at all locations for this project. Each RRFB unit shall be completely installed and made operable by the Contractor within 30 days of each location and RRFB unit being made available to the contractor.

This project is on an expedited schedule. Time is of the essence in the performance of the work of this contract. The Contractor shall organize its operations and mobilize sufficient personnel and equipment, and work the required overtime to complete the project within the timeframe specified herein.

Failure to initiate and/or complete work by the above described timeframe shall require the Contractor to pay the City as Liquidated Damages, and not as penalty, the sum of \$500 dollars for each and every calendar day that the Contractor may be in default of initiation and/or completion of the specified work, within the time stated, or time extension(s) granted thereto.

All liquidated damages amounts are additive and may be charged concurrently. Should the Engineer approve a request for an extension of contract time, liquidated damages will be based on the revised time for which the extension specifically applies.

Costs for the Contractor to organize, coordinate, and schedule all of the work of the project, will not be paid for separately, but shall be considered to be included in the bid price for the individual Contract items.

**DETAILED SPECIFICATION
FOR
PROJECT SUPERVISION**

DESCRIPTION

The Contractor shall designate a Project Supervisor to act as the Contractor's agent/representative, and to be responsible for scheduling and coordination of all subcontractors, suppliers, other governmental agencies, and all public and private utility companies.

The Project Supervisor shall not be an active crew member of the Contractor, shall not be an active member or employee of any subcontractor's work force, and shall not perform general or specialized labor tasks.

Prior to the pre-construction meeting, the Contractor shall designate a proposed Project Supervisor by name, and shall furnish the City with a current, thorough, detailed summary of the proposed Project Supervisor's work history, outlining all previous supervisory experience on projects of a similar size and nature. The detailed work history shall include personal and professional references (names and phone numbers) of persons (previous owners or agents) who can attest to the qualifications and work history of the proposed Project Supervisor. Proposed candidates for Project Supervisor shall have a demonstrated ability to work harmoniously with the City, the public, subcontractors, and all other parties typically involved with work of this nature. The Supervising Professional will have the authority to reject a proposed Project Supervisor whom he/she considers unqualified.

The Project Supervisor shall be available 24 hours-per-day to provide proper supervision, coordination and scheduling of the project for the duration of the Contract. The Contractor shall furnish the City with telephone numbers of the Project Supervisor in order to provide 24 hour-per-day access during business and non-business hours, including weekends and holidays.

The Project Supervisor shall be equipped by the Contractor with a mobile telephone to provide the City with 24 hour-per-day access to him/her during daily construction activities, during transit to and from the construction site, and during all non-business hours including weekends and holidays.

The Project Supervisor shall be equipped with assistants as necessary to provide project supervision as specified herein, and in accordance with the Contract.

DUTIES AND RESPONSIBILITIES

The Project Supervisor work harmoniously with the City, the public, subcontractors, and all other parties typically involved with work of this nature.

The Project Supervisor shall have a thorough, detailed understanding and working knowledge of all construction practices and methods specified elsewhere herein.

The Project Supervisor shall be responsible for all of the work of all of the Contractor's, subcontractors' and suppliers' work forces.

The Project Supervisor shall be responsible for proper and adequate maintenance (emissions, safety, and general operation) of all of the Contractor's, subcontractors' and suppliers' equipment and vehicles.

The Project Supervisor shall be responsible for the legal, proper and safe parking/storage of all of the Contractor's, subcontractors' and suppliers' equipment, work vehicles, and employee's vehicles.

The Project Supervisor shall schedule and coordinate the work of all parties involved in the project, including utility companies, testing agencies, governmental agencies, all City departments (such as Utilities and Transportation), and City inspectors.

The Project Supervisor shall coordinate and schedule both Testing inspectors and City inspectors in a timely manner, to assure proper and timely testing and inspection of the work.

The Project Supervisor shall review the Inspector's Daily Reports (IDRs) for accuracy, and shall sign all IDRs on a daily basis as the representative of the Contractor. Items to be reviewed include descriptions, locations and measurements of quantities of work performed, workforce, equipment, and weather. The Project Supervisor shall also be responsible for its subcontractors' review and initialing of IDRs containing work items performed by each respective subcontractors.

The Project Supervisor shall submit to the Engineer, an updated, detailed schedule of the proposed work on a weekly basis, and an update of all proposed changes on a daily basis, all in accordance with the Detailed Specification for Project Schedule contained elsewhere herein.

The Project Supervisor shall schedule and chair a weekly progress meeting with the Engineer and all subcontractors to discuss the work. Upon the completion of each meeting, the Project Supervisor shall prepare and distribute, to all present, a written summary of the meeting's minutes. Those in attendance shall review the minutes and, if necessary, comment on any deficiencies or errors prior to or at the next scheduled progress meeting.

Should, in the sole opinion of the Supervising Professional, the Project Supervisor fail to perform his/her duties and responsibilities as described herein to such a degree that the successful completion of the project is put in jeopardy, the Contractor shall immediately replace the Project Supervisor upon receipt of written notice. Failure to provide adequate project supervision, as determined by the Engineer, shall be considered basis for the Supervising Professional to suspend work without extension of contract time or additional compensation.

Costs for Project Supervision will not be paid for separately, but shall be considered to be included in the bid price for the individual Contract items.

**DETAILED SPECIFICATION
FOR
GENERAL CONDITIONS**

DESCRIPTION

General Conditions include, but are not limited to, items such as:

- Scheduling and organization of all work, subcontractors, suppliers, and inspection
- Coordination of, and cooperation with, other contractors, agencies, departments, and utilities
- Protection and maintenance of street features such as signs, signals, trees, etc.
- Placing, maintaining, and removing all soil erosion and sedimentation controls
- Maintaining drainage
- Maintaining drives, drive openings, sidewalks, bikepaths, mail deliveries, and solid waste/recycle pick-ups
- Storing all materials and equipment off lawn areas
- Site clean-up
- Mobilization(s) and demobilization(s)
- Furnishing submittals and certifications for materials and supplies
- Parking meter bags
- Disposing of materials and debris
- All miscellaneous and incidental items such as overhead, insurance, bonds, and permits.

Costs for General Conditions will not be paid for separately, but shall be considered to be included in the bid price for the individual Contract items.

**DETAILED SPECIFICATION
FOR
TRAFFIC CONTROL**

DESCRIPTION

This work shall consist of protecting and maintaining vehicular and pedestrian traffic, in accordance with Sections 103.05, 103.06, and 812, of the 2012 MDOT Standard Specifications for Construction; Part 6 of the Michigan Manual of Uniform Traffic Control Devices, Latest Revised Edition (MMUTCD); and the City Standard Specifications, except as modified herein.

MATERIALS, EQUIPMENT, AND METHODS

The work of Traffic Control shall include, but not be limited to:

- The furnishing and operating of lighted plastic drums
- The furnishing and operating of Type III lighted barricades
- The furnishing and operating of all temporary “Type B” signs
- The furnishing and operating of arrow panels as required by the Engineer
- The furnishing of signposts and installation of No Parking signs
- The furnishing and operating of miscellaneous signs, warning devices, flag-persons, and cones;
- The operation of additional signs furnished by the City;
- Furnishing and installing meter bags;
- Coordinating with the City to have meter heads removed and reinstalled;
- Maintaining pedestrian traffic;
- Temporarily covering traffic controls;
- Temporarily covering existing signs as directed;
- Any and all other miscellaneous and/or incidental items which are necessary to properly perform the work.

Materials and equipment shall meet the requirements specified in the above-designated sections of the MDOT Standard Specifications.

The Contractor shall maintain two-way traffic on streets, and keep all driveways and intersections open to traffic at all times, unless specifically authorized otherwise in writing by the Engineer. The Contractor shall maintain traffic such that no vehicle shall be required to drive into active work areas. The Contractor shall maintain vehicular and pedestrian traffic during the work by the use of flag-persons, channelizing devices, and signs as necessary, as directed by the Engineer, and in accordance with MMUTCD.

The Contractor shall maintain pedestrian traffic at all times. Sidewalk closure shall be permitted only if authorized in writing by the engineer. Where such sidewalk closure is permitted, the contractor shall place Type I barricades, “Sidewalk Closed” signs, “Cross Here” signs, and other measures necessary to maintain safe pedestrian traffic.

All temporary traffic/pedestrian control devices furnished by the Contractor shall remain the property of the Contractor. The City shall not be responsible for stolen or damaged signs, barricades, barricade lights or other traffic maintenance items. The Contractor shall replace missing traffic control devices immediately, at no additional cost to the City.

A lane-closure permit shall be obtained by the Contractor from the City at least 48 hours in advance of work at each location. The City will provide the permits at no cost to the Contractor.

The hours of lane closures and work on all Major Streets are 9:00 a.m. to 3:00 p.m., Monday through Saturday. No equipment will be allowed in the street before or after these hours. The City may impose additional restrictions on work hours due to planned events (e.g. Art Fair, UM Football) or circumstances which may result in increased traffic during

work hours.

The Contractor shall temporarily cover conflicting traffic and/or parking signs when directed by the Engineer.

Parking violation citations issued to the Contractor, subcontractor and material suppliers, including their employees, shall be enforced under appropriate City Code.

The Contractor shall replace missing or damaged traffic control devices, as directed by the Engineer. When traffic control devices have been damaged by, or due to, the negligence of the Contractor, his subcontractors or material suppliers, the traffic control devices shall be replaced at the Contractor's expense.

The Contractor shall furnish and operate all lighted arrow boards; lighted plastic drums; type III barricades; and Type B temporary signs as directed by the Engineer. Specifically:

- Lighted Arrow boards shall be type A or B as directed by the Engineer, and shall be electric powered (either battery or solar). Motor generators using gasoline, diesel, LP gas, or other such fuel are not approved for use.
- Type III Barricades shall have standard orange-and-white stripes on both sides of the barricade.
- "Construction Ahead" warning signs shall be placed as directed by the Engineer prior to the start of work, regardless of the nature, magnitude, or duration of the work.

Sufficient signs shall be provided by the Contractor to insure the safety of the workers and the general public in accordance with the current MMUTCD.

Prohibiting Parking

On occasions where the Contractor shall need to reserve parking areas for staging equipment, prior to the commencement of any construction activity, the Contractor shall place No-Parking signs as directed by the Engineer. The Contractor shall obtain a permit for "Temporary Permission of Reserve Parking Lane for Work Related Purposes" from the City of Ann Arbor Project Management Services Unit. This permit shall be obtained a minimum of 5 days prior to the posting of No-Parking signs.

The City will furnish No-Parking signs to the Contractor at no cost. The Contractor shall furnish the signposts and shall securely bolt the signs to the signposts as directed by the Engineer. The Contractor shall install the signposts at least 2-feet deep into the ground, and there shall be a minimum 6-foot and maximum 7-foot clearance maintained between the bottom of the sign and the ground. The signs shall be placed at 75-foot intervals (or as necessary) to eliminate parking in the construction area.

The installation of No-Parking signs shall be in accordance with the permit. No-Parking signs shall be installed by the Contractor, as directed by the Engineer, **at least 48 hours prior to the proposed start-of-work/enforcement date.**

No-Parking signs shall be returned to the City at the completion of the work. The cost of unreturned signs will be back charged to the Contractor.

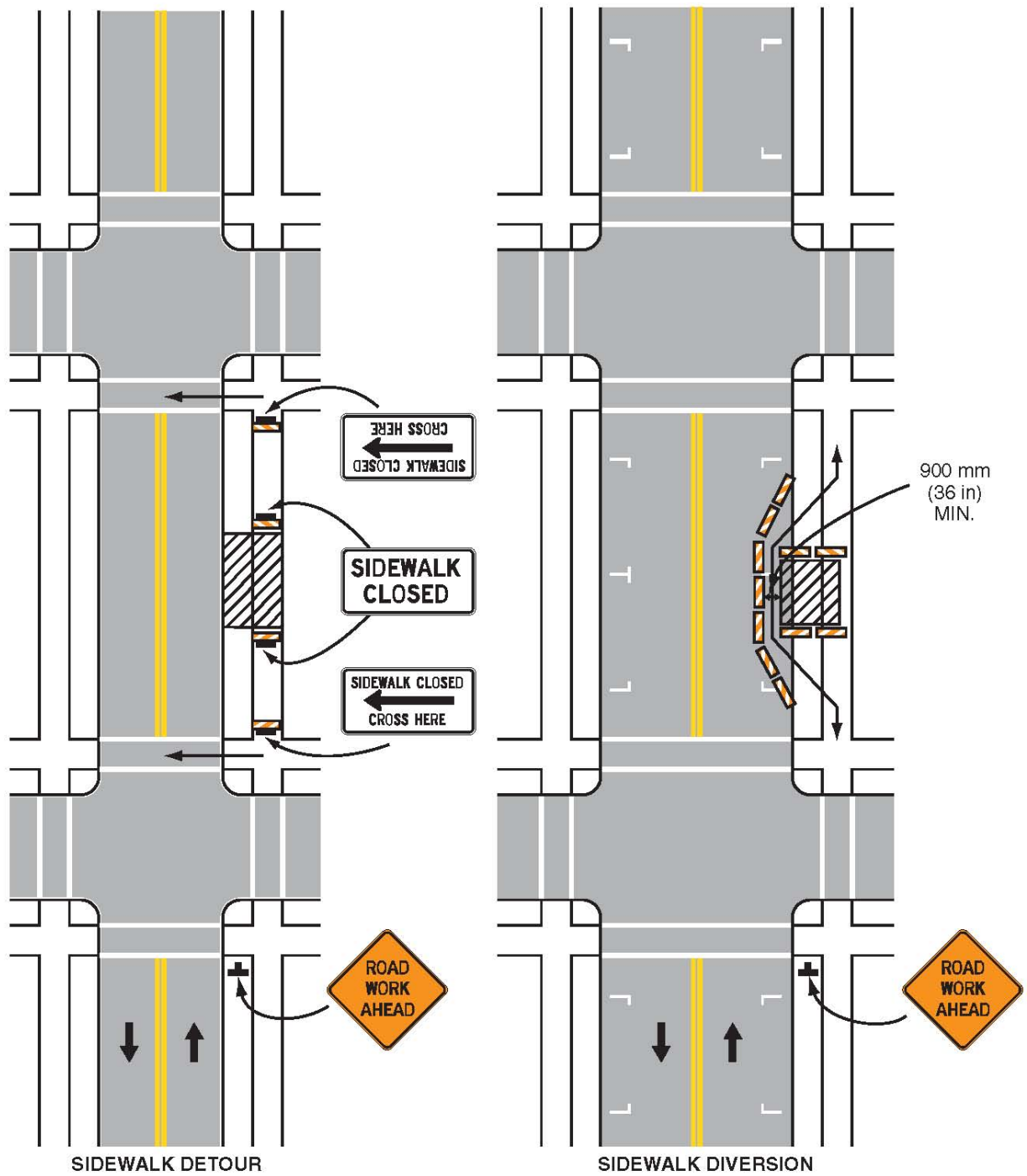
No-Parking signs shall be covered by the Contractor, thereby allowing on-street parking, until between 48 and 36 hours prior to the start of the work. No-Parking signs shall be covered by the Contractor whenever there is no work being performed for a period of time longer than 72 hours.

Where there is metered parking, the Contractor shall install meter bags.

Costs for Project Supervision will not be paid for separately, but shall be considered to be included in the bid price for the individual Contract items.

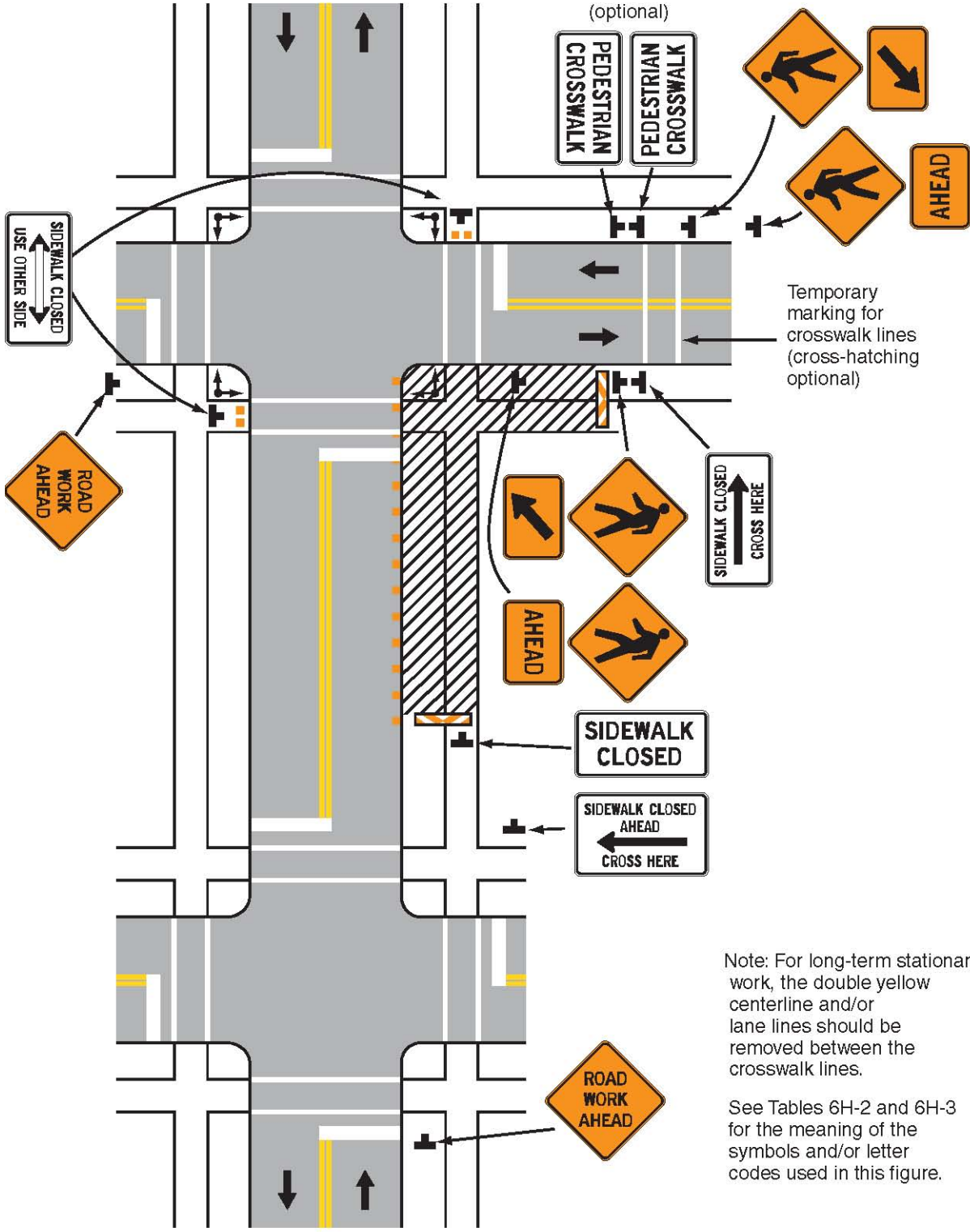


Figure 6H-28. Sidewalk Detour or Diversion (MI) (TA-28)



Typical Application 28

Figure 6H-29. Cross walk Closures and Pedestrian Detours (MI) (TA-29)



Note: For long-term stationary work, the double yellow centerline and/or lane lines should be removed between the crosswalk lines.

See Tables 6H-2 and 6H-3 for the meaning of the symbols and/or letter codes used in this figure.

Typical Application 29

**DETAILED SPECIFICATION
FOR
COORDINATION AND COOPERATION WITH OTHERS
AND
WORK BY OTHERS**

The Contractor is reminded as to the requirements of article 104.07 of the 2012 edition of the MDOT Standard Specifications, "Cooperation by the Contractor."

The Contractor shall directly coordinate his/her work with individual City Departments/Divisions/Units.

The Contractor is hereby notified that the City of Ann Arbor Field Services Unit may be installing traffic control conduits, traffic signal sensors, and the like, at various locations.

No additional compensation will be paid to the Contractor, and no adjustments to contract unit prices will be made, due to delays and/or the failure of others in the performance of their work, nor for delays due to the encountering of existing utilities that are, or are not, shown on the Plans.

The following Utility Owners may have overhead and/or underground facilities located within the Right-of-Way:

- The City of Ann Arbor
- DTE - MichCon (Michigan Consolidated Gas Company)
- DTE - Edison (Detroit Edison Company)
- SBC - (Ameritech)
- Comcast
- MCI Communications
- Sprint Communications
- The University of Michigan

On all projects:

"3 Working Days before you Dig - Call MISS DIG - Toll Free" Phone No. 1-800-482-7171.

The Owners of public or private utilities which will not interfere with the completed project and which do not present a hazard to the public or an extraordinary hazard to the Contractor's operations will not be required to move their facilities on or from the street right-of-way.

Stoppages created solely by the operations of the utility companies which delay utility revisions on any portion of this project may be considered as a basis of claim for an extension of time for project completion.

Costs for this work will not be paid for separately, but shall be included in the bid price of the Contract Item "General Conditions."

**DETAILED SPECIFICATION
FOR
PROTECTION OF UTILITIES**

Damages to utilities by the Contractor's operations shall be repaired by the utility owner at the Contractor's expense. Delays to the work due to utility repairs are the sole responsibility of the Contractor.

The Contractor shall keep construction debris out of utilities at all times. The Contractor shall be back charged an amount of \$50.00 per day for each manhole/inlet/utility pipe that contains construction debris caused as a result of the Contractor's (including subcontractors and suppliers) work.

The Contractor is solely responsible for any damages to the utilities or abutting properties due to construction debris.

Certain sanitary and storm sewers within the influence of construction may have been cleaned and videotaped prior to construction. The City may also choose to videotape utility line(s) during or after the work of this Contract to inspect them for damages and/or construction debris. If such inspection shows damage and/or debris, then all costs of such inspection, cleaning, repairs, etc, shall be the Contractor's sole responsibility. If such inspection is negative, the City will be responsible for the costs of such inspection.

Costs for this work will not be paid for separately, but shall be included in the bid price of the Contract Item "General Conditions."

**DETAILED SPECIFICATION
FOR
SITE CLEAN-UP**

Immediately after completion of construction on each street, the Contractor shall clean the entire area within the influence of construction, including but not limited to all pavement, sidewalks, lawn areas, and underground utility structures, of all materials which may have accumulated prior to or during the construction.

Costs for this work will not be paid for separately, but shall be included in the bid price of the Contract Item "General Conditions."

**DETAILED SPECIFICATION
FOR
BUY AMERICAN IRON AND STEEL**

The Contractor acknowledges to and for the benefit of the City of Ann Arbor ("Purchaser") that it understands the goods and services under this Agreement comply with provisions commonly known as "American Iron and Steel (AIS);" that require all iron and steel products used in the project be produced in the United States ("AIS Requirements") including iron and steel provided by the Contractor pursuant to this Agreement.

The Contractor hereby represents and warrants to and for the benefit of the Purchaser that (a) the Contractor has reviewed and understands the AIS Requirements, (b) all iron and steel used in the project will be and/or have been produced in the United States in a manner that complies with the AIS Requirements, and (c) the Contractor will provide any further verified information, certification or assurance of compliance with this paragraph, or information necessary to support a waiver of the AIS requirements, as may be requested by the Purchaser.

**DETAILED SPECIFICATION
FOR
PARKING METER COVERS (METER BAGS)**

A portion of the proposed work may be along streets which contain parking meters for on-street parking. The Contractor shall coordinate with the Engineer and **Republic Parking, telephone (734) 761-7235** to obtain a sufficient number of Parking Meter Covers (Meter Bags), which, when properly installed by the Contractor in a timely manner, will prohibit parking at metered parking spaces. Generally, there is no cost to the contractor for meter bags required for City projects.

Meter Bags must be installed a minimum of 24-hours prior to the desired time of enforcement. Written documentation and/or visual inspection by City personnel may be required to adequately verify this requirement.

The Parking Enforcement Office of the Police Department will be unable to enforce the desired "No-Parking Zone" unless the Contractor installs the Meter Bags in a proper and timely manner.

The Contractor has the sole responsibility for Meter Bag placement and maintenance. Delays due to on-street parking shall not be cause for any extra payments to the Contractor.

Information regarding Meter Bags, and the temporary prohibition of on-street parking, is available from **Republic Parking, telephone (734) 761-7235**.

**DETAILED SPECIFICATION
FOR
MATERIALS AND SUPPLIES CERTIFICATIONS**

The following materials and supplies shall be certified by the manufacturer or supplier as having been tested for compliance with the Specifications:

- HMA materials
- Hot-poured Joint Sealants
- Cements, coatings, admixtures and curing materials
- Sands and Aggregates
- Steel and Fabricated metal
- Portland Cement Concrete Mixtures
- Reinforcing Steel for Concrete
- Reinforcing Fibers for Concrete
- Pre-cast Concrete products
- Sanitary Sewer Pipe
- Storm Sewer Pipe
- Water Main Pipe
- Corrugated Metal Pipe
- High Density Polyethylene Pipe
- Timber for retaining walls
- Modular Concrete Block for retaining walls
- Edge Drain and Underdrain Pipe
- Geotextile Filter Fabric and Stabilization Fabric/Grids

The Contractor shall submit all certifications to the Engineer for review and approval a minimum of three business days prior to any scheduled delivery, installation, and/or construction of same.

Costs for this work will not be paid for separately, but shall be included in the bid price of the Contract Item "General Conditions."

**DETAILED SPECIFICATION
FOR
CONTRACT DRAWINGS/PLANS**

The Contractor shall carefully check and review all Drawings/Plans and advise the Engineer of any errors or omissions discovered. The Drawings/Plans may be supplemented by such additional Drawings/Plans and sketches as may be necessary or desirable as the work progresses. The Contractor shall perform all work shown on any additional or supplemental Drawings/Plans issued by the Engineer.

**DETAILED SPECIFICATION
FOR
QUANTITIES AND UNIT PRICES**

Quantities as given are approximate and are estimated for bidding purposes. Quantities are not guaranteed and may vary by any amount. While it is the City's intent to complete the project substantially as drawn and specified herein, quantities may be changed or reduced to zero for cost savings or other reasons. **The City reserves the right to change the quantities, delete streets, or add streets, and no adjustment in unit price will be made for any change in any quantity.**

**DETAILED SPECIFICATION
FOR
WORKING IN THE RAIN**

The Contractor shall not work in the rain unless authorized in writing by the Engineer.

The Engineer may delay or stop the work due to threatening weather conditions.

The Contractor shall not be compensated for unused materials or downtime due to rain, or the threat of rain.

The Contractor is solely responsible for repairing all damages to the work and to the site, including road infrastructures, road subgrades, and any adjacent properties, which are caused as a result of working in the rain.

**DETAILED SPECIFICATION
FOR
WORKING IN THE DARK**

The Contractor shall not work in the dark except as approved by the Engineer and only when lighting for night work is provided as detailed elsewhere in this contract.

The Engineer may stop the work, or may require the Contractor to defer certain work to another day, if, in the Engineer's opinion, the work cannot be completed within the remaining daylight hours, or if inadequate daylight is present to either properly perform or inspect the work.

The Contractor will not be compensated for unused materials or downtime, when delays or work stoppages are directed by the Engineer for darkness and/or inadequate remaining daylight reasons.

The Contractor is solely responsible for repairing all damages to the work and to the site, including road infrastructures, road subgrades, and any adjacent properties, which are caused as a result of working in the dark.

**DETAILED SPECIFICATION
FOR
GENERAL CONSTRUCTION NOTES**

The following notes pertain to all Plan sheets issued as part of this Contract, and these notes shall be considered part of each Plan sheet or Detailed Information Sheet.

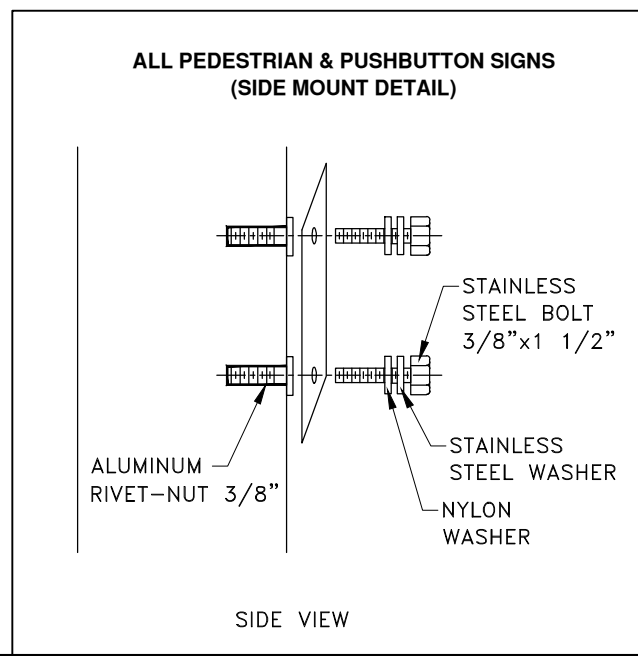
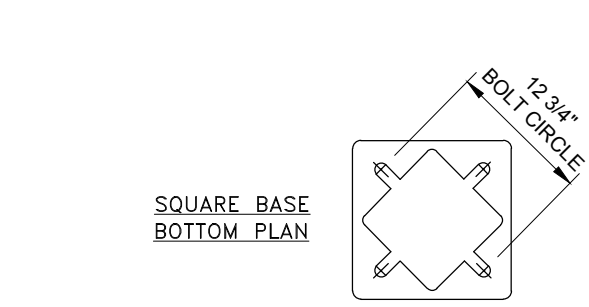
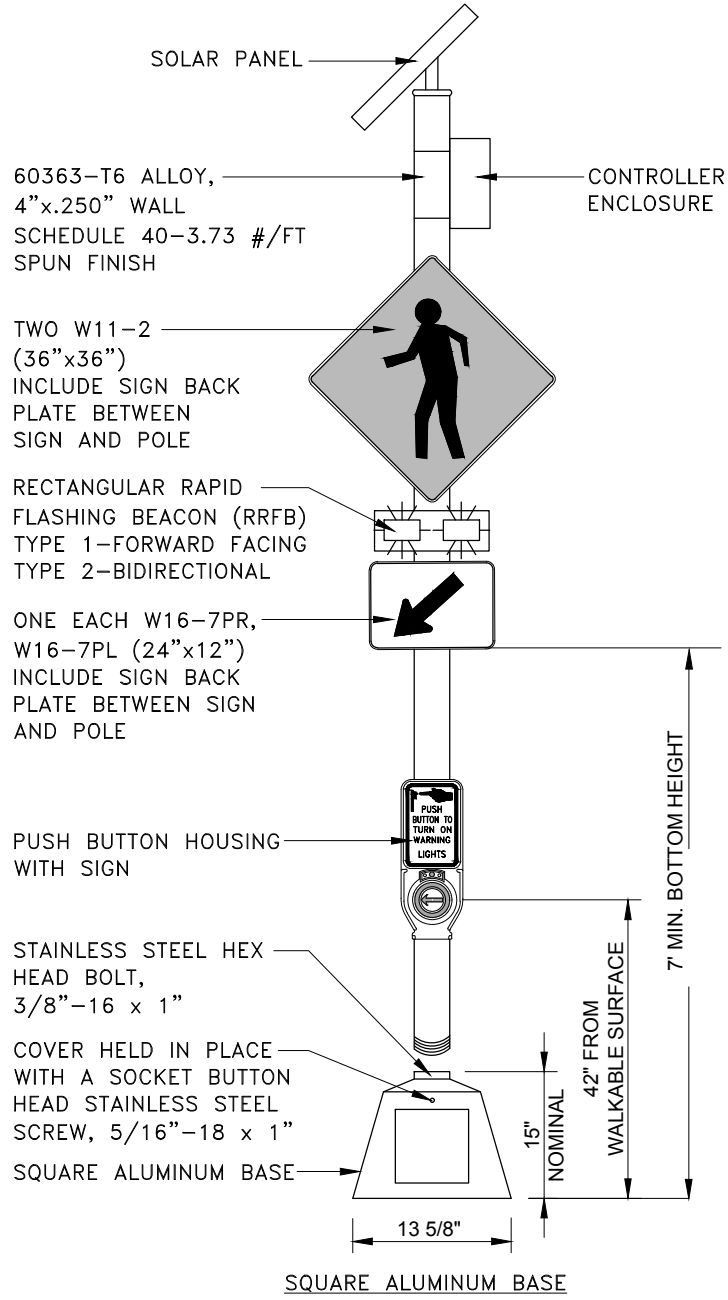
1. All work shall conform to latest revision of the City Standard Specifications.
2. The Contractor shall maintain access to all drives throughout the course of construction. Drives shall never be closed during non-working hours, unless otherwise authorized in writing by the Engineer.
3. The Contractor shall completely restore all existing site features to better than, or equal to, their existing condition.
4. The Contractor shall be aware that there are above-ground and below-ground utilities existing in and on these streets which include, but are not limited to: gas mains and service leads; water mains and service leads; storm sewer mains and service leads; sanitary sewer mains and service leads; telephone poles, wires, cables and conduits; electrical poles, wires, cables and conduits; cable television wires, cables and conduits, and other various utilities. The Contractor shall conduct all of its work so as not to damage or alter in any way, any existing utility, except where specified on the Plans or where directed by the Engineer. The City has videotaped and cleaned all sanitary and storm sewers, including storm sewer inlet leads, and has found all of these facilities to be in good condition, with the exception of those shown on the Plans for repairs or replacement.
5. The Contractor is solely responsible for any delays, damages, costs and/or charges incurred due to and/or by reason of any utility, structure, feature and/or site condition, whether shown on the Plans or not, and the Contractor shall repair and/or replace, at its sole expense, to as good or better condition, any and all utilities, structures, features and/or site conditions which are impacted by reason of the work, or injured by its operations, or injured during the operations of its subcontractors or suppliers.
6. No extra payments or adjustments to unit prices will be made for damages, delays, costs and/or charges due to existing utilities, structures, features and/or site conditions not shown or being incorrectly shown or represented on the Plans.

APPENDICES

Appendix 1 - RRFB Assembly Details

Appendix 2 - Location Map

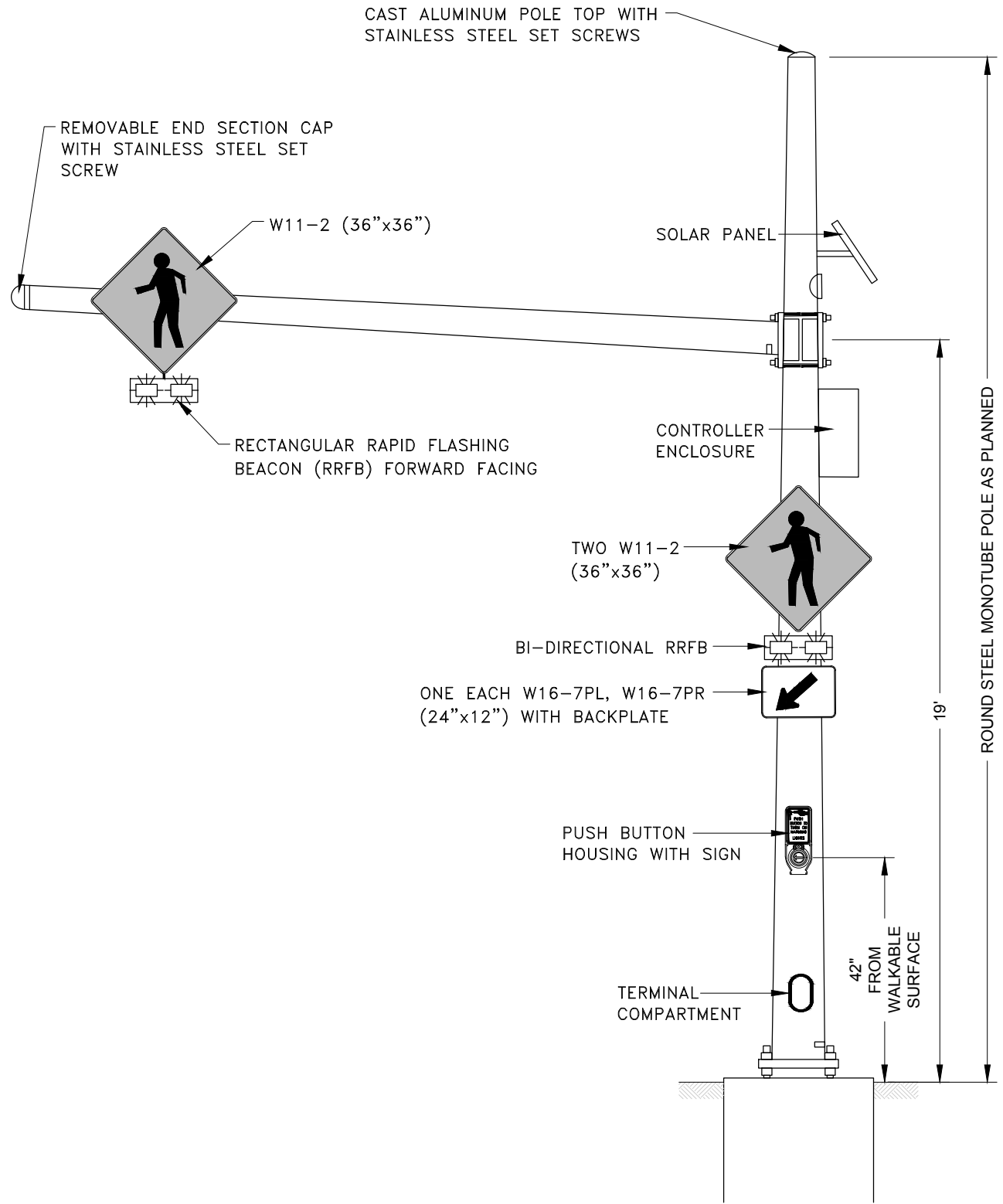
**RECTANGULAR RAPID FLASHING BEACON ASSEMBLY
TYPE 1 & 2**



**CITY OF ANN ARBOR
PUBLIC SERVICES**
301 EAST HURON STREET
P.O. BOX 8647
ANN ARBOR, MI 48107-8647
734-794-6410
www.a2gov.org

REV. NO.	DATE	DRAWN BY	CHECKED BY
RRFB ASSEMBLY			
DR. ARG	CH. BMS		
SCALE N.T.S.	DATE 4-28-17	SHEET 1 OF 2	

**RECTANGULAR RAPID FLASHING BEACON ASSEMBLY
TYPE 3**








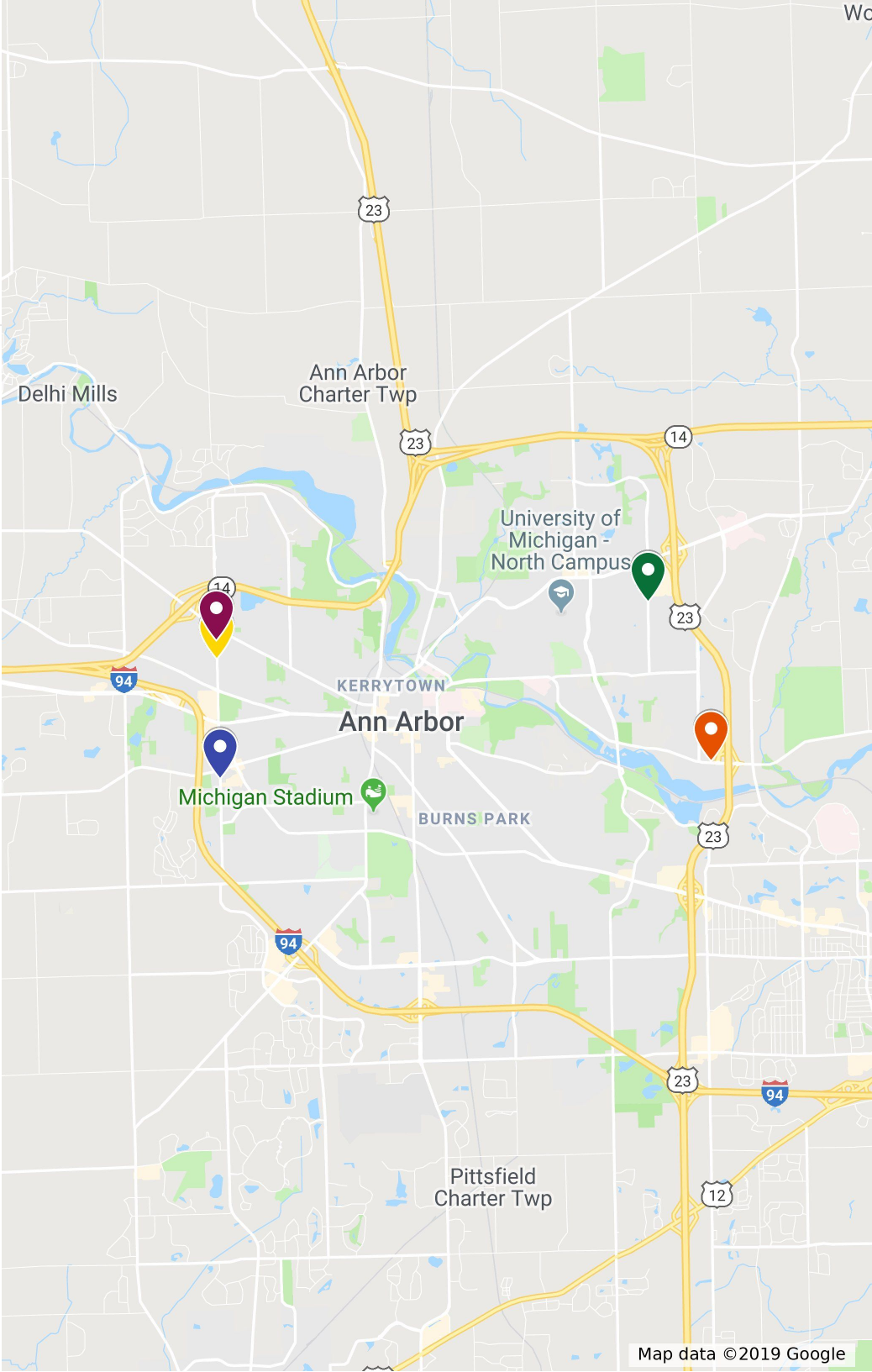
**CITY OF ANN ARBOR
PUBLIC SERVICES**
301 EAST HURON STREET
P.O. BOX 8647
ANN ARBOR, MI 48107-8647
734-794-6410
www.a2gov.org

REV. NO.	DATE	DRAWN BY	CHECKED BY
RRFB ASSEMBLY			
DR. ARG	CH. BMS		
SCALE N.T.S.	DATE 4-28-17	SHEET 2 OF 2	

Appendix 2

2019 RRFB Installations - Location Map

-  Green at Greenbrier
-  Geddes east of Earhart
-  N Maple near S Circle
-  N Maple, near Sequoia
-  S. Maple, near Bens



**CITY OF ANN ARBOR
PREVAILING WAGE DECLARATION OF COMPLIANCE**

The "wage and employment requirements" of Section 1:320 of Chapter 14 of Title I of the Ann Arbor City Code mandates that the city not enter any contract, understanding or other arrangement for a public improvement for or on behalf of the city unless the contract provides that all craftsmen, mechanics and laborers employed directly on the site in connection with said improvements, including said employees of subcontractors, shall receive the prevailing wage for the corresponding classes of craftsmen, mechanics and laborers, as determined by statistics for the Ann Arbor area compiled by the United States Department of Labor. Where the contract and the Ann Arbor City Code are silent as to definitions of terms required in determining contract compliance with regard to prevailing wages, the definitions provided in the Davis-Bacon Act as amended (40 U.S.C. 278-a to 278-a-7) for the terms shall be used. Further, to the extent that any employees of the contractor providing services under this contract are not part of the class of craftsmen, mechanics and laborers who receive a prevailing wage in conformance with section 1:320 of Chapter 14 of Title I of the Code of the City of Ann Arbor, employees shall be paid a prescribed minimum level of compensation (i.e. Living Wage) for the time those employees perform work on the contract in conformance with section 1:815 of Chapter 23 of Title I of the Code of the City of Ann Arbor.

At the request of the city, any contractor or subcontractor shall provide satisfactory proof of compliance with this provision.

The Contractor agrees:

- (a) To pay each of its employees whose wage level is required to comply with federal, state or local prevailing wage law, for work covered or funded by this contract with the City,
- (b) To require each subcontractor performing work covered or funded by this contract with the City to pay each of its employees the applicable prescribed wage level under the conditions stated in subsection (a) or (b) above.
- (c) To provide to the City payroll records or other documentation within ten (10) business days from the receipt of a request by the City.
- (d) To permit access to work sites to City representatives for the purposes of monitoring compliance, and investigating complaints or non-compliance.

The undersigned states that he/she has the requisite authority to act on behalf of his/her employer in these matters and has offered to provide the services in accordance with the terms of the wage and employment provisions of the Chapter 14 of the Ann Arbor City Code. The undersigned certifies that he/she has read and is familiar with the terms of Section 1:320 of Chapter 14 of the Ann Arbor City Code and by executing this Declaration of Compliance obligates his/her employer and any subcontractor employed by it to perform work on the contract to the wage and employment requirements stated herein. The undersigned further acknowledges and agrees that if it is found to be in violation of the wage and employment requirements of Section 1:320 of the Chapter 14 of the Ann Arbor City Code it shall be deemed a material breach of the terms of the contract and grounds for termination of same by the City.

J. Ranck Electric, Inc.
Company Name

March 20, 2019
Date

Jim Levert, Estimator
Signature of Authorized Representative

1993 Gover Parkway, Mt. Pleasant, MI 48858
Address, City, State, Zip

(989) 775-7393 / jlevert@jranck.com
Phone/Email address

Questions about this form? Contact Procurement Office City of Ann Arbor Phone: 734/794-6500

**CITY OF ANN ARBOR
LIVING WAGE ORDINANCE DECLARATION OF COMPLIANCE**

The Ann Arbor Living Wage Ordinance (Section 1:811-1:821 of Chapter 23 of Title I of the Code) requires that an employer who is (a) a contractor providing services to or for the City for a value greater than \$10,000 for any twelve-month contract term, or (b) a recipient of federal, state, or local grant funding administered by the City for a value greater than \$10,000, or (c) a recipient of financial assistance awarded by the City for a value greater than \$10,000, shall pay its employees a prescribed minimum level of compensation (i.e., Living Wage) for the time those employees perform work on the contract or in connection with the grant or financial assistance. The Living Wage must be paid to these employees for the length of the contract/program.

Companies employing fewer than 5 persons and non-profits employing fewer than 10 persons are exempt from compliance with the Living Wage Ordinance. If this exemption applies to your company/non-profit agency please check here No. of employees _____

The Contractor or Grantee agrees:

- (a) To pay each of its employees whose wage level is not required to comply with federal, state or local prevailing wage law, for work covered or funded by a contract with or grant from the City, no less than the Living Wage. The current Living Wage is defined as \$13.22/hour for those employers that provide employee health care (as defined in the Ordinance at Section 1:815 Sec. 1 (a)), or no less than \$14.75/hour for those employers that do not provide health care. The Contractor or Grantor understands that the Living Wage is adjusted and established annually on April 30 in accordance with the Ordinance and covered employers shall be required to pay the adjusted amount thereafter to be in compliance with Section 1:815(3).

Check the applicable box below which applies to your workforce

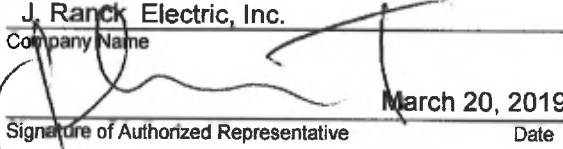
Employees who are assigned to any covered City contract/grant will be paid at or above the applicable living wage without health benefits

Employees who are assigned to any covered City contract/grant will be paid at or above the applicable living wage with health benefits

- (a) To post a notice approved by the City regarding the applicability of the Living Wage Ordinance in every work place or other location in which employees or other persons contracting for employment are working.
- (b) To provide to the City payroll records or other documentation within ten (10) business days from the receipt of a request by the City.
- (c) To permit access to work sites to City representatives for the purposes of monitoring compliance, and investigating complaints or non-compliance.
- (d) To take no action that would reduce the compensation, wages, fringe benefits, or leave available to any employee covered by the Living Wage Ordinance or any person contracted for employment and covered by the Living Wage Ordinance in order to pay the living wage required by the Living Wage Ordinance.

The undersigned states that he/she has the requisite authority to act on behalf of his/her employer in these matters and has offered to provide the services or agrees to accept financial assistance in accordance with the terms of the Living Wage Ordinance. The undersigned certifies that he/she has read and is familiar with the terms of the Living Wage Ordinance, obligates the Employer/Grantee to those terms and acknowledges that if his/her employer is found to be in violation of Ordinance it may be subject to civil penalties and termination of the awarded contract or grant of financial assistance.

J. Ranck Electric, Inc.
Company Name


Signature of Authorized Representative

March 20, 2019
Date

Jim Levert, Estimator
Print Name and Title

1993 Gover Parkway
Street Address

Mt. Pleasant, MI 48858
City, State, Zip

(989) 775-7393
Phone/Email address

CITY OF ANN ARBOR LIVING WAGE ORDINANCE

RATE EFFECTIVE APRIL 30, 2018 - ENDING APRIL 29, 2019

\$13.22 per hour

If the employer provides health care benefits*

\$14.75 per hour

If the employer does **NOT** provide health care benefits*

Employers providing services to or for the City of Ann Arbor or recipients of grants or financial assistance from the City of Ann Arbor for a value of more than \$10,000 in a twelve-month period of time must pay those employees performing work on a City of Ann Arbor contract or grant, the above living wage.

ENFORCEMENT

The City of Ann Arbor may recover back wages either administratively or through court action for the employees that have been underpaid in violation of the law. Persons denied payment of the living wage have the right to bring a civil action for damages in addition to any action taken by the City.

Violation of this Ordinance is punishable by fines of not more than \$500/violation plus costs, with each day being considered a separate violation. Additionally, the City of Ann Arbor has the right to modify, terminate, cancel or suspend a contract in the event of a violation of the Ordinance.

* Health Care benefits include those paid for by the employer or making an employer contribution toward the purchase of health care. The employee contribution must not exceed \$.50 an hour for an average work week; and the employer cost or contribution must equal no less than \$1/hr for the average work week.

The Law Requires Employers to Display This Poster Where Employees Can Readily See It.

**For Additional Information or to File a Complaint Contact:
Colin Spencer at 734/794-6500 or cspencer@a2gov.org**



Vendor Conflict of Interest Disclosure Form

All vendors interested in conducting business with the City of Ann Arbor must complete and return the Vendor Conflict of Interest Disclosure Form in order to be eligible to be awarded a contract. Please note that all vendors are subject to comply with the City of Ann Arbor's conflict of interest policies as stated within the certification section below.

If a vendor has a relationship with a City of Ann Arbor official or employee, an immediate family member of a City of Ann Arbor official or employee, the vendor shall disclose the information required below.

- 1. No City official or employee or City employee's immediate family member has an ownership interest in vendor's company or is deriving personal financial gain from this contract.
2. No retired or separated City official or employee who has been retired or separated from the City for less than one (1) year has an ownership interest in vendor's Company.
3. No City employee is contemporaneously employed or prospectively to be employed with the vendor.
4. Vendor hereby declares it has not and will not provide gifts or hospitality of any dollar value or any other gratuities to any City employee or elected official to obtain or maintain a contract.
5. Please note any exceptions below:

Conflict of Interest Disclosure
Name of City of Ann Arbor employees, elected officials or immediate family members with whom there may be a potential conflict of interest.
() Relationship to employee
() Interest in vendor's company
() Other (please describe in box below)
None

*Disclosing a potential conflict of interest does not disqualify vendors. In the event vendors do not disclose potential conflicts of interest and they are detected by the City, vendor will be exempt from doing business with the City.

J. Rank Electric, Inc. (989) 775-7393
03/20/2019 Jim Levert

Questions about this form? Contact Procurement Office City of Ann Arbor Phone: 734/794-6500, procurement@a2gov.org

**CITY OF ANN ARBOR
DECLARATION OF COMPLIANCE**

Non-Discrimination Ordinance

The "non discrimination by city contractors" provision of the City of Ann Arbor Non-Discrimination Ordinance (Ann Arbor City Code Chapter 112, Section 9:158) requires all contractors proposing to do business with the City to treat employees in a manner which provides equal employment opportunity and does not discriminate against any of their employees, any City employee working with them, or any applicant for employment on the basis of actual or perceived age, arrest record, color, disability, educational association, familial status, family responsibilities, gender expression, gender identity, genetic information, height, HIV status, marital status, national origin, political beliefs, race, religion, sex, sexual orientation, source of income, veteran status, victim of domestic violence or stalking, or weight. It also requires that the contractors include a similar provision in all subcontracts that they execute for City work or programs.

In addition the City Non-Discrimination Ordinance requires that all contractors proposing to do business with the City of Ann Arbor must satisfy the contract compliance administrative policy adopted by the City Administrator. A copy of that policy may be obtained from the Purchasing Manager

The Contractor agrees:

- (a) To comply with the terms of the City of Ann Arbor's Non-Discrimination Ordinance and contract compliance administrative policy, including but not limited to an acceptable affirmative action program if applicable.
- (b) To post the City of Ann Arbor's Non-Discrimination Ordinance Notice in every work place or other location in which employees or other persons are contracted to provide services under a contract with the City.
- (c) To provide documentation within the specified time frame in connection with any workforce verification, compliance review or complaint investigation.
- (d) To permit access to employees and work sites to City representatives for the purposes of monitoring compliance, or investigating complaints of non-compliance.

The undersigned states that he/she has the requisite authority to act on behalf of his/her employer in these matters and has offered to provide the services in accordance with the terms of the Ann Arbor Non-Discrimination Ordinance. The undersigned certifies that he/she has read and is familiar with the terms of the Non-Discrimination Ordinance, obligates the Contractor to those terms and acknowledges that if his/her employer is found to be in violation of Ordinance it may be subject to civil penalties and termination of the awarded contract.

J. Ranck Electric, Inc.
Company Name


Signature of Authorized Representative

March 20, 2019
Date

Jim Levert, Estimator
Print Name and Title

1993 Gover Parkway, Mt. Pleasant, MI 48858
Address, City, State, Zip

(989) 775-7393 / jlevert@jranck.com
Phone/Email Address

**Questions about the Notice or the City Administrative Policy, Please contact:
Procurement Office of the City of Ann Arbor
(734) 794-6500**

CITY OF ANN ARBOR NON-DISCRIMINATION ORDINANCE

Relevant provisions of Chapter 112, Nondiscrimination, of the Ann Arbor City Code are included below.
You can review the entire ordinance at www.a2gov.org/humanrights.

Intent: It is the intent of the city that no individual be denied equal protection of the laws; nor shall any individual be denied the enjoyment of his or her civil or political rights or be discriminated against because of actual or perceived age, arrest record, color, disability, educational association, familial status, family responsibilities, gender expression, gender identity, genetic information, height, HIV status, marital status, national origin, political beliefs, race, religion, sex, sexual orientation, source of income, veteran status, victim of domestic violence or stalking, or weight.

Discriminatory Employment Practices: No person shall discriminate in the hire, employment, compensation, work classifications, conditions or terms, promotion or demotion, or termination of employment of any individual. No person shall discriminate in limiting membership, conditions of membership or termination of membership in any labor union or apprenticeship program.

Discriminatory Effects: No person shall adopt, enforce or employ any policy or requirement which has the effect of creating unequal opportunities according to actual or perceived age, arrest record, color, disability, educational association, familial status, family responsibilities, gender expression, gender identity, genetic information, height, HIV status, marital status, national origin, political beliefs, race, religion, sex, sexual orientation, source of income, veteran status, victim of domestic violence or stalking, or weight for an individual to obtain housing, employment or public accommodation, except for a bona fide business necessity. Such a necessity does not arise due to a mere inconvenience or because of suspected objection to such a person by neighbors, customers or other persons.

Nondiscrimination by City Contractors: All contractors proposing to do business with the City of Ann Arbor shall satisfy the contract compliance administrative policy adopted by the City Administrator in accordance with the guidelines of this section. All city contractors shall ensure that applicants are employed and that employees are treated during employment in a manner which provides equal employment opportunity and tends to eliminate inequality based upon any classification protected by this chapter. All contractors shall agree not to discriminate against an employee or applicant for employment with respect to hire, tenure, terms, conditions, or privileges of employment, or a matter directly or indirectly related to employment, because of any applicable protected classification. All contractors shall be required to post a copy of Ann Arbor's Non-Discrimination Ordinance at all work locations where its employees provide services under a contract with the city.

Complaint Procedure: If any individual believes there has been a violation of this chapter, he/she may file a complaint with the City's Human Rights Commission. The complaint must be filed within 180 calendar days from the date of the individual's knowledge of the allegedly discriminatory action or 180 calendar days from the date when the individual should have known of the allegedly discriminatory action. A complaint that is not filed within this timeframe cannot be considered by the Human Rights Commission. To file a complaint, first complete the complaint form, which is available at www.a2gov.org/humanrights. Then submit it to the Human Rights Commission by e-mail (hrc@a2gov.org), by mail (Ann Arbor Human Rights Commission, PO Box 8647, Ann Arbor, MI 48107), or in person (City Clerk's Office). For further information, please call the commission at 734-794-6141 or e-mail the commission at hrc@a2gov.org.

Private Actions For Damages or Injunctive Relief: To the extent allowed by law, an individual who is the victim of discriminatory action in violation of this chapter may bring a civil action for appropriate injunctive relief or damages or both against the person(s) who acted in violation of this chapter.

THIS IS AN OFFICIAL GOVERNMENT NOTICE AND
MUST BE DISPLAYED WHERE EMPLOYEES CAN READILY SEE IT.

MICHIGAN DEPARTMENT OF TRANSPORTATION CERTIFIED PAYROLL

COMPLETION OF CERTIFIED PAYROLL FORM FULFILLS THE MINIMUM MDOT PREVAILING WAGE REQUIREMENTS

(1) NAME OF CONTRACTOR / SUBCONTRACTOR (CIRCLE ONE) (2) ADDRESS

(3) PAYROLL NO. (4) FOR WEEK ENDING (5) PROJECT AND LOCATION (6) CONTRACT ID

(a)	(b)	(c)	(d) DAY AND DATE							(e)	(f)	(g)	(h)	(i)	(j) DEDUCTIONS						(k)
															TOTAL HOURS ON PROJECT	PROJECT RATE OF PAY	PROJECT RATE OF FRINGE PAY	GROSS PROJECT EARNED	GROSS WEEKLY EARNED	TOTAL WEEKLY HOURS WORKED ALL JOBS	
EMPLOYEE INFORMATION	WORK CLASSIFICATION	Hour Type	HOURS WORKED ON PROJECT							TOTAL HOURS ON PROJECT	PROJECT RATE OF PAY	PROJECT RATE OF FRINGE PAY	GROSS PROJECT EARNED	GROSS WEEKLY EARNED	TOTAL WEEKLY HOURS WORKED ALL JOBS	FICA	FEDERAL	STATE	OTHER	TOTAL DEDUCT	TOTAL WEEKLY WAGES PAID FOR ALL JOBS
NAME:									0				\$0.00							\$0.00	\$0.00
ETH#GEN: ID #:	GROUP/CLASS #:	S							0											\$0.00	\$0.00
NAME:									0				\$0.00							\$0.00	\$0.00
ETH#GEN: ID #:	GROUP/CLASS #:	S							0											\$0.00	\$0.00
NAME:									0				\$0.00							\$0.00	\$0.00
ETH#GEN: ID #:	GROUP/CLASS #:	S							0											\$0.00	\$0.00
NAME:									0				\$0.00							\$0.00	\$0.00
ETH#GEN: ID #:	GROUP/CLASS #:	S							0											\$0.00	\$0.00
NAME:									0				\$0.00							\$0.00	\$0.00
ETH#GEN: ID #:	GROUP/CLASS #:	S							0											\$0.00	\$0.00
NAME:									0				\$0.00							\$0.00	\$0.00
ETH#GEN: ID #:	GROUP/CLASS #:	S							0											\$0.00	\$0.00
NAME:									0				\$0.00							\$0.00	\$0.00
ETH#GEN: ID #:	GROUP/CLASS #:	S							0											\$0.00	\$0.00
NAME:									0				\$0.00							\$0.00	\$0.00

Date _____

I, _____ (Name of Signatory Party) _____ (Title)

do hereby state:

(1) That I pay or supervise the payment of the persons employed by

_____ on the _____
 (Contractor or Subcontractor)
 _____; that during the payroll period commencing on the _____
 (Building or Work)
 _____ day of _____, _____, and ending the _____ day of _____, _____,
 all persons employed on said project have been paid the full weekly wages earned, that no rebates have been or will be made either directly or indirectly to or on behalf of said

_____ from the full
 (Contractor or Subcontractor)

weekly wages earned by any person and that no deductions have been made either directly or indirectly from the full wages earned by any person, other than permissible deductions as defined in Regulations, Part 3 (29 C.F.R. Subtitle A), issued by the Secretary of Labor under the Copeland Act, as amended (48 Stat. 948, 63 Stat. 108, 72 Stat. 967; 76 Stat. 357; 40 U.S.C. § 3145), and described below:

(2) That any payrolls otherwise under this contract required to be submitted for the above period are correct and complete; that the wage rates for laborers or mechanics contained therein are not less than the applicable wage rates contained in any wage determination incorporated into the contract; that the classifications set forth therein for each laborer or mechanic conform with the work he performed.

(3) That any apprentices employed in the above period are duly registered in a bona fide apprenticeship program registered with a State apprenticeship agency recognized by the Bureau of Apprenticeship and Training, United States Department of Labor, or if no such recognized agency exists in a State, are registered with the Bureau of Apprenticeship and Training, United States Department of Labor.

(4) That:

(a) WHERE FRINGE BENEFITS ARE PAID TO APPROVED PLANS, FUNDS, OR PROGRAMS

- in addition to the basic hourly wage rates paid to each laborer or mechanic listed in the above referenced payroll, payments of fringe benefits as listed in the contract have been or will be made to appropriate programs for the benefit of such employees, except as noted in section 4(c) below.

(b) WHERE FRINGE BENEFITS ARE PAID IN CASH

- Each laborer or mechanic listed in the above referenced payroll has been paid, as indicated on the payroll, an amount not less than the sum of the applicable basic hourly wage rate plus the amount of the required fringe benefits as listed in the contract, except as noted in section 4(c) below.

(c) EXCEPTIONS

EXCEPTION (CRAFT)	EXPLANATION

REMARKS:

NAME AND TITLE	SIGNATURE

THE WILLFUL FALSIFICATION OF ANY OF THE ABOVE STATEMENTS MAY SUBJECT THE CONTRACTOR OR SUBCONTRACTOR TO CIVIL OR CRIMINAL PROSECUTION. SEE SECTION 1001 OF TITLE 18 AND SECTION 231 OF TITLE 31 OF THE UNITED STATES CODE.