

ANN ARBOR HISTORIC DISTRICT COMMISSION

Staff Report

ADDRESS: 218 N. Division Street, Application Number HDC22-1157

DISTRICT: Old Fourth Ward Historic District

REPORT DATE: August 11, 2022

REPORT PREPARED BY: Jill Thacher, Historic Preservation Coordinator

REVIEW COMMITTEE DATE: August 8, 2022

OWNER

Name: David Kennedy
Address: 218 N. Division Street
 Ann Arbor, MI
Phone: 734-657-8901

APPLICANT

Marc Rueter
 515 Fifth Street
 Ann Arbor, MI 48103
 (734)769-0070

BACKGROUND: The John Maynard House, built in 1844, is a Classic Revival house featuring a low gabled roof and symmetrical façade with five evenly spaced double-hung windows with heavy lintels. On the 1908 Sanborn, the house (labeled Boarding House) has two additional single-story additions behind the existing rear wing. Remodeled in 1910, the central entry was moved to a side hall entry and a full two-story Colonial Revival front porch was added.

The house was a student chapel from 1942-46, home to Canterbury House beginning around 1950 and the Trailblazers Clubhouse from 1992. A fire escape was added in 1997 (visible in some of the application photos). In 2002 an application to remove the rear wing and construct a new two-story addition was denied by the HDC. Later in 2002, an application to repair and restore the house and return it to single-family occupancy was approved. The central entry was reestablished at that time.

In June of 2018, the HDC approved an application to expand an existing patio behind the southeast corner of the house; install a masonry and wood privacy fence; install a 12' x 9' spa pool; construct a 20' x 12' pergola; construct an outdoor masonry bar and grill; and remove two windows and replace them with a four-light sliding door. In May of 2019, the HDC approved an application to replace the front walkway with brick pavers; add a covered porch structure to the rear east-facing door; add retaining walls, steps, and landscaping near the rear door.

APPLICATION: The applicant seeks HDC approval to move a first-floor window opening on the south elevation 38" to the west, infill the original opening, and install a new wood window. A second new wood window would replace an existing window next to the moved one, to the east.

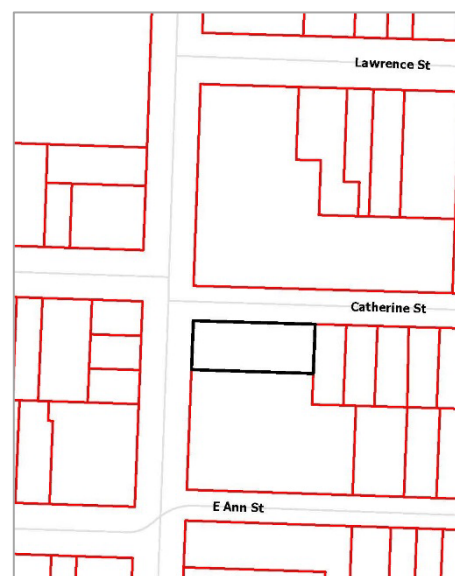

APPLICABLE REGULATIONS

From the Secretary of the Interior's Standards for Rehabilitation:

- (1) A property will be used as it was historically or be given a new use that requires minimal change to its distinctive materials, features, spaces, and spatial relationships.
- (2) The historic character of a property shall be retained and preserved. The removal of historic materials or alteration of features and spaces that characterize a property shall be avoided.
- (9) New additions, exterior alterations, or related new construction shall not destroy historic materials that characterize the property. The new work shall be differentiated from the old and shall be compatible with the massing, size, scale, and architectural features to protect the historic integrity of the property and its environment.
- (10) New additions and adjacent or related new construction shall be undertaken in such a manner that if removed in the future, the essential form and integrity of the historic property and its environment would be unimpaired.

From the Secretary of the Interior's Guidelines for Rehabilitating Historic Buildings (other SOI Guidelines may also apply):

Windows

Not Recommended: Introducing a new design that is incompatible with the historic character of the building.

Changing the number, location, size, or glazing pattern of windows, through cutting new openings, blocking-in windows, and installing replacement sash which does not fit the historic window opening.

Removing or radically changing windows which are important in defining the historic character of the building so that, as a result, the character is diminished.

From the Ann Arbor Historic District Design Guidelines (other Guidelines may apply):

Windows

Appropriate: Retaining and maintaining windows in good condition. Normal maintenance will include cleaning, sash cord replacement, limited paint removal, re-caulking where necessary, and new paint to make windows fully operable.

Not Appropriate: Removing or radically changing a window that is important in defining the overall historic character of the property.

STAFF FINDINGS:

1. The south elevation of the house originally had five windows across the second floor, and on the first floor, a center door with two windows on each side, aligned vertically with the second-floor windows. The house has undergone several transformations since then, resulting in numerous windows being infilled, added, and moved. In 1910 the exterior was remodeled in the Colonial Revival style by adding the large front porches, dormers, and center portico, and the entrance door was moved to the south (you can see this in the c. 1942-46 photo at the end of this staff report). In 2004 the house was restored by David Kwan and returned to use as a single-family home. The front entry was returned to the center of the west elevation, most or all of the windows were replaced, the fire escape was removed, and much other work was done.
2. The existing windows that are proposed to be replaced are from the 2004 renovations. The wood Marvin windows proposed to replace the replacements are compatible with other wood replacement windows on the house and are appropriate.
3. The window opening proposed to be moved is an opening that is original to the house. Looking at sheet 3 of the applicant's attachments, a missing window on the second floor would have been aligned with this window (the brick has obviously been infilled and patched). Moving the window as shown on sheet 4 brings it out of alignment with both the center window on the second floor and the missing window that was above its current location.
4. The historic character of the building is defined in large part by its symmetry, which would be diminished if this window were moved. Should the HDC decide it is appropriate to move the window, some record of its exact location should be made in the brick infill, possibly by inseting the perimeter brick or all of the infill by 2" or more.

POSSIBLE MOTIONS: (Note that the motion is only a suggestion. The Review Committee, consisting of staff and at least two Commissioners, will meet with the applicant on site and then make a recommendation at the meeting.)

I move that the Commission approve the application at 218 N. Division Street, a contributing property in the Old Fourth Ward Historic District, to move a first-floor window opening on the south elevation 38" to the west, infill the original opening, and install a new wood window. A second new wood window would replace an existing window next to the moved one, to the east. As proposed, the work is compatible in exterior design, arrangement, texture, material and relationship to the rest of the building and the surrounding area and meets *The Secretary of the Interior's Standards for Rehabilitation and Guidelines for Rehabilitating Historic Buildings*, in particular standards 1, 2, 9 and 10 and the guidelines for building site and entrances and porches and the *Ann Arbor Historic District Design Guidelines* for residential landscape features.

MOTION WORKSHEET:

I move that the Commission issue a Certificate of Appropriateness for the work at 218 N. Division in the Old Fourth Ward Historic District

_____ Provided the following condition(S) is (ARE) met: 1) STATE CONDITION(s)

The work is generally compatible with the size, scale, massing, and materials and meets the Secretary of the Interior's Standards for Rehabilitation, standard(S) number(S) (*circle all that apply*): 1, 2, 3, 4, 5, 6, 7, 8, 9, 10

ATTACHMENTS: application, drawings

218 N. Division Street (August 2016 Google Street View)



Photo of the south elevation taken prior to the 2004 remodel (courtesy of the homeowner)



Photo from a previous HDC application date 12/1/2001



218 N. Division, Students' Evangelical Chapel (1942-46)



Undated photo courtesy AADL Old News

https://aadl.org/aastreet/site1/aastreet_north_division_300 :

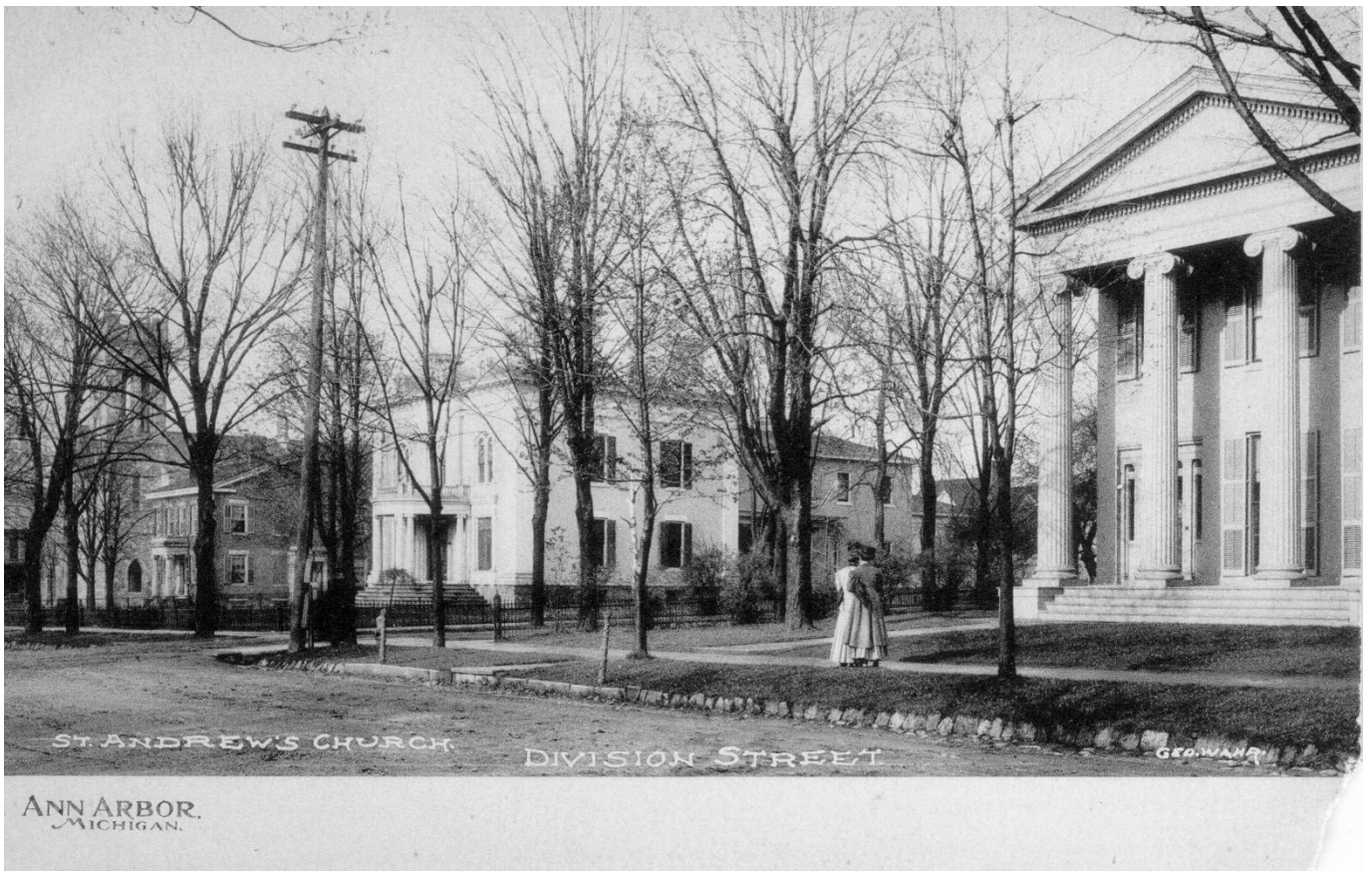

DESCRIPTION:

MOVE EXISTING WINDOW OPENING, SILL AND LINTEL 38" TO THE WEST PATCH OPENING WITH EXISTING BRICK.

INSTALL TWO NEW WOOD WINDOWS TO MATCH SIZE OF OPENING (SEE SHEET NO. 5 FOR WINDOW SPECIFICATIONS).

WINDOW DETAILS

Scale: 1/8" = 1'-0" on 8 1/2" x 11"

218 NORTH DIVISION STREET STREET ANN ARBOR MI 07.21.2022

■ RUETER ASSOCIATES ■
ARCHITECTS
515 Fifth Street, Ann Arbor, Michigan 48103
phone: (734) 769-0070, fax: (734) 769-0167
RAA: 14-010 00.00.14

CATHERINE STREET

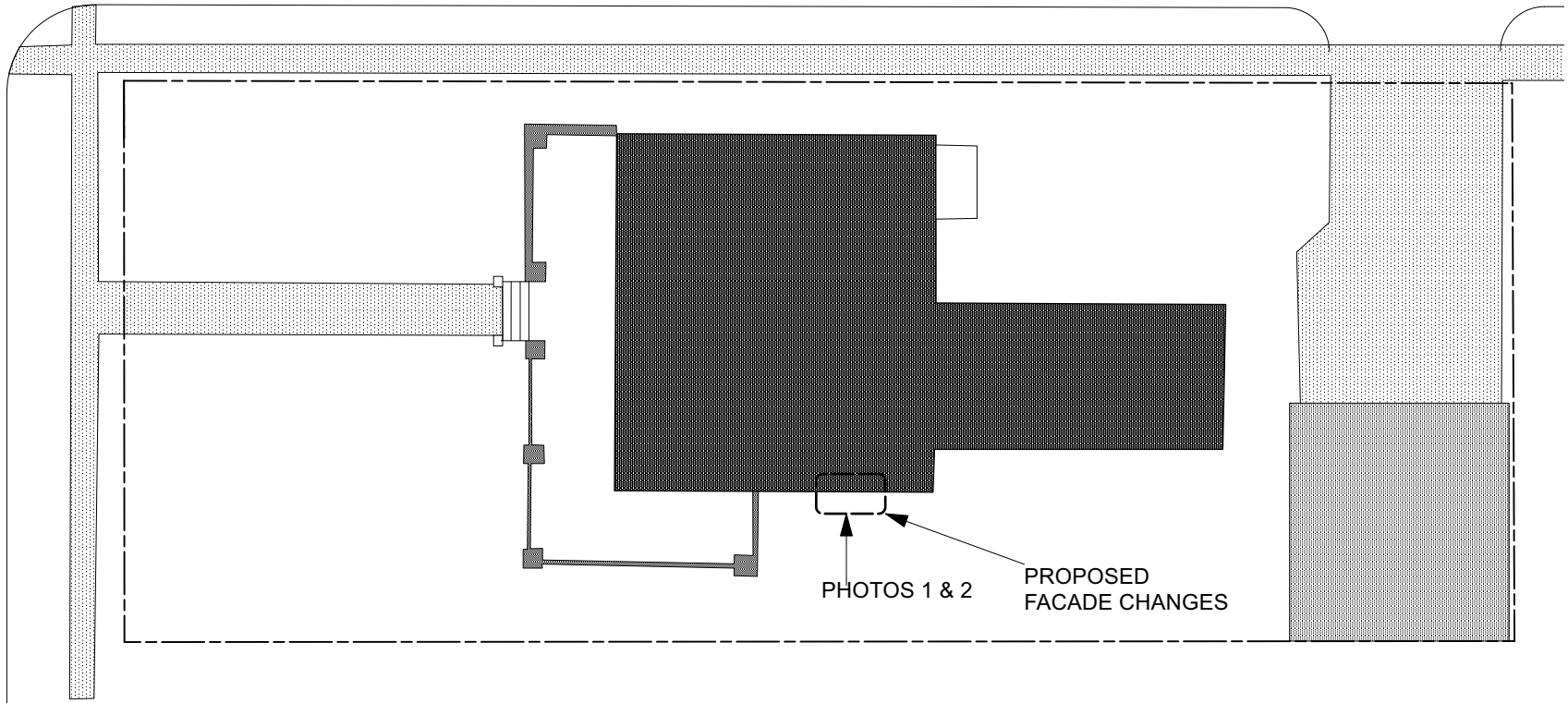

SCHEMATIC SITE PLAN

SCALE" 1" = 20'-0"

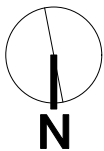

□ SITE PLAN

Scale: 1/8" = 1'-0" on 8 1/2" x 11"

218 NORTH DIVISION STREET STREET ANN ARBOR MI

07.21.2022

■ RUETER ASSOCIATES ■
ARCHITECTS
515 Fifth Street, Ann Arbor, Michigan 48103
phone: (734) 769-0070, fax: (734) 769-0167
RAA: 14-010 00.00.14

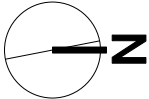
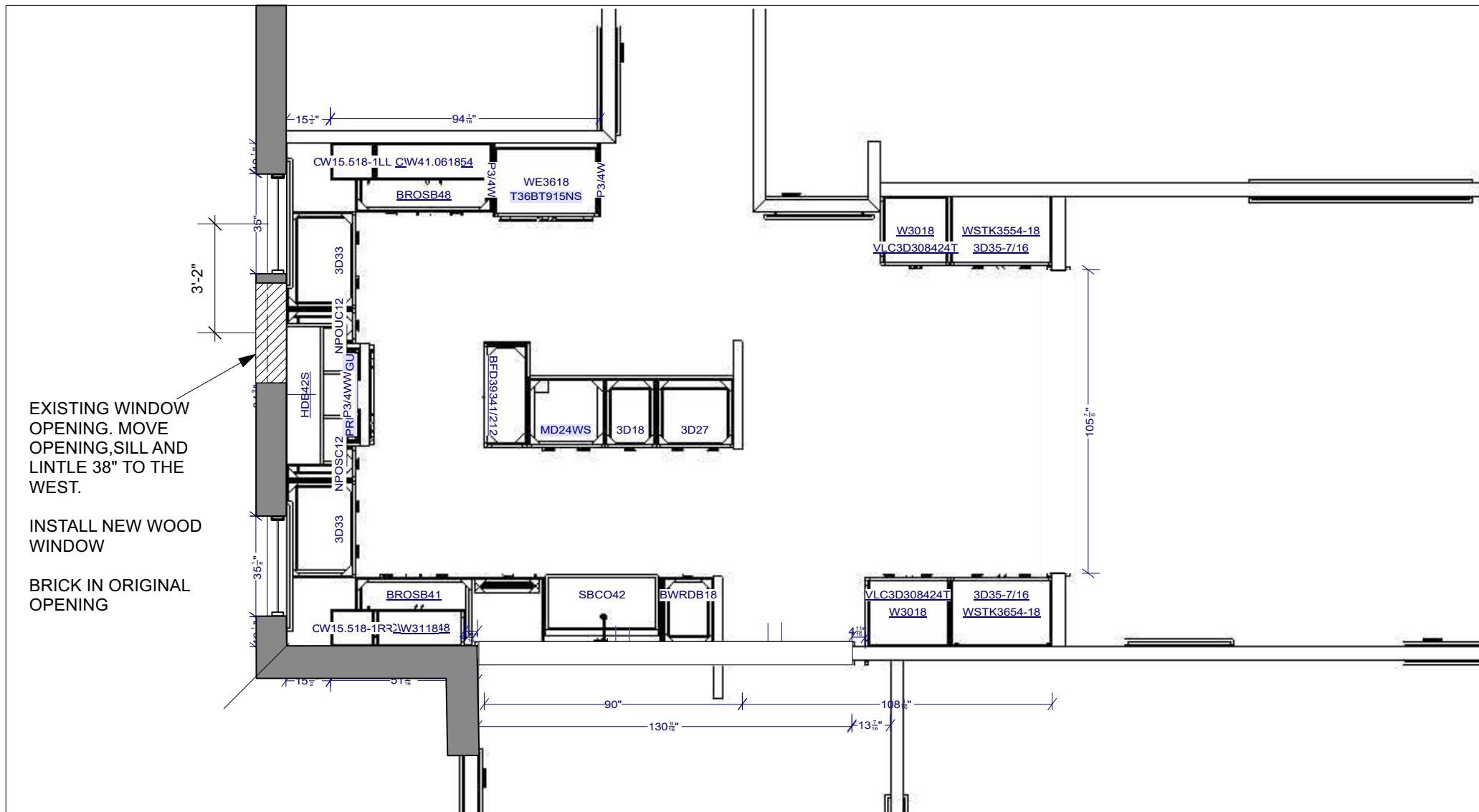

All dimensions size designations given are subject to verification on job site and adjustment to fit job conditions.



This is an original design and must not be released or copied unless applicable fee has been paid or job order placed.

Designed: 7/20/20
Printed: 7/20/20



PROPOSED WINDOW TO BE MOVED

2022
2022

8" 1'

PHOTO BEFORE PROPOSED CHANGE

Scale: 1/8" = 1'-0" on 8 1/2" x 11"

218 NORTH DIVISION STREET STREET ANN ARBOR MI 07.21.2022

■ RUETER ASSOCIATES ■
ARCHITECTS
515 Fifth Street, Ann Arbor, Michigan 48103
phone: (734) 769-0070, fax: (734) 769-0167
RAA: 14-010 00.00.14



REPLACE FRAME
AND SASH ONLY IN
THIS WINDOW

WINDOW MOVED 38" WEST
AND OLD OPENING
BRICKED IN

□ PHOTO AFTER PROPOSED CHANGE

Scale: 1/8" = 1'-0" on 8 1/2" x 11"

218 NORTH DIVISION STREET STREET ANN ARBOR MI 07.21.2022

■ RUETER ASSOCIATES ■
ARCHITECTS
515 Fifth Street, Ann Arbor, Michigan 48103
phone: (734) 769-0070, fax: (734) 769-0167
RAA: 14-010 00.00.14

Section Details: Operating

Scale: 3" = 1' 0"

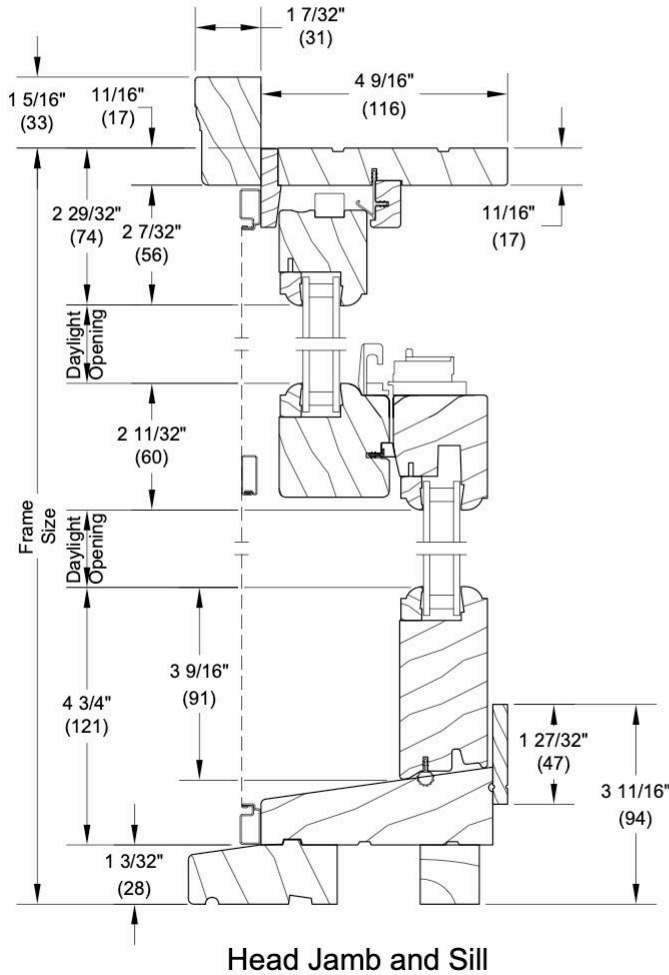

Double Hung

