

CITY OF ANN ARBOR
CONTRACT DOCUMENTS



Street Resurfacing - 2017

May 2017

Public Services Area
Project Management Services Unit

City of Ann Arbor
301 E. Huron Street
Ann Arbor, MI 48104

TABLE OF CONTENTS

TABLE OF CONTENTS.....	TC-1 to 2
NOTICE OF PRE-BID CONFERENCE.....	NP-1
Pre-Bid Conference Summary	Addendum-2-4 to 5
Pre-Bid Conference Sign-In Sheet.....	Addendum-2-6
INSTRUCTIONS TO BIDDERS	IB-1 to 5
INVITATION TO BID.....	ITB-1 to 3
Addendum No. 1.....	ADD-1-1
Addendum No. 2.....	Addendum-2-1 to 3
Addendum No. 3.....	Addendum-3-1
Addendum No. 4.....	Addendum-4-1
BID FORMS.....	Addendum-2-7 to 14 (BF-1 to 8) and BF-9 to 12
CONTRACT.....	C-1 to 4
BOND FORMS.....	B-1 to 2
GENERAL CONDITIONS	GC-1 to 16
STANDARD SPECIFICATIONS	SS-1
DETAILED SPECIFICATIONS.....	(see page numbering below)
DS for General Conditions.....	DS-1 to 2
DS for Project Supervision	DS-3 to 6
DS for Certified Payroll Compliance and Reporting.....	DS-7 to 8
DS for Vacuum Type Cleaning Equipment.....	DS-9
DS for Materials and Supplies Certifications	DS-10
DS for Project Schedule includes "Schedule of Streets"	DS-11 to 12 and Addendum-2-15 to 16 (DS-13 to 14)
DS for Landscape Boulder.....	Addendum-2-17
DS for Parking Blocks	Addendum-2-18
DS for Removing Concrete Items.....	DS-15 to 16
DS for Machine Grading.....	DS-17 to 22
DS for Subgrade Undercutting.....	DS-23
DS for Sidewalk, Sidewalk Ramp, and Driveway Approach Grading.....	DS-24
DS for Soil Erosion and Sedimentation Control - Inlet Filter	DS-25
DS for Geosynthetic Paving Layer	Addendum-2-23 to 24
DS for Drainage and Utility Structures.....	Addendum-2-19 (DS-26)
DS for Structure Covers.....	DS-27 to 28
DS for Adjusting Structure Covers.....	Addendum-2-20 to 21 (DS-29 to 30)
DS for Drainage Structure, Double Inlet	DS-31 to 32
DS for Subgrade Underdrain	DS-33 to 35
DS for HMA Application Estimate.....	Addendum-2-22 (DS-36)
DS for HMA Paving	DS-37 to 39
DS for HMA Traffic Calming Measures	DS-40
DS for HMA, Wedging, 36A.....	DS-41
DS for Removing Hot Mix Asphalt Around Structure Covers.....	DS-42
DS for Flowable Fill	DS-43 to 44

TABLE OF CONTENTS (continued)

DS for Concrete Placement and Protection	DS-45 to 46
DS for Concrete Curb and Gutter, and Driveway Openings	DS-47 to 50
DS for Concrete Sidewalk, Sidewalk Ramps, and Driveway Approaches	Addendum-2-25 to 26 (DS-51 to 52)
DS for Sidewalk Retaining Walls	Addendum-2-27 to 30 (DS-53 to 55)
DS for Detectable Warning Surface	DS-56 to 64
DS for Cast Iron Detectable Warning Surface.....	Addendum-2-31
DS for Removal and Reinstallation of Concrete or Clay Brick Pavers	DS-65 to 66
DS for Fence, Protective, Modified	DS-67 to 68
DS for Pavement Markings.....	DS-69
DS for Wet Reflective Liquid Applied Pavement Markings	Addendum-2-32 to 33
DS for Maintenance of Traffic.....	Addendum-2-34 to 38 (DS-70 to 74) and DS-75 to 98
DS for Minor Traffic Control	DS-99 to 102
DS for No Parking Signs.....	DS-103
DS for Protecting and Preserving Irrigation Systems	DS-104
DS for Slope Restoration	DS-105 to 106
DS for Electrical and Communication Handholes.....	DS-107 to 108
DS for Parking Meters	Addendum-2-39 to 40
APPENDIX.....	APDX-1
Notices to Bidders	
Michigan Department of Transportation (MDOT) Special Provisions	
MDOT Supplemental Specifications	
MDOT Standard Plans	
Special Details	
Soil Boring Logs	

ATTACHMENTS

City of Ann Arbor Prevailing Wage Declaration Form
City of Ann Arbor Living Wage Forms
City of Ann Arbor Vendor Conflict of Interest Disclosure Form
City of Ann Arbor Non-Discrimination Ordinance Notice and Declaration Form
MDOT Certified Payroll Forms

TABLE OF CONTENTS (continued)

DS for Maintenance of Traffic.....	DS-70 to 98
DS for Minor Traffic Control	DS-99 to 102
DS for No Parking Signs.....	DS-103
DS for Protecting and Preserving Irrigation Systems	DS-104
DS for Slope Restoration	DS-105 to 106
DS for Electrical and Communication Handholes.....	DS-107 to 108
APPENDIX.....	APDX-1
Notices to Bidders	
Michigan Department of Transportation (MDOT) Special Provisions	
MDOT Supplemental Specifications	
MDOT Standard Plans	
Special Details	
Soil Boring Logs	

ATTACHMENTS

City of Ann Arbor Prevailing Wage Declaration Form
City of Ann Arbor Living Wage Forms
City of Ann Arbor Vendor Conflict of Interest Disclosure Form
City of Ann Arbor Non-Discrimination Ordinance Notice and Declaration Form
MDOT Certified Payroll Forms

NOTICE OF PRE-BID CONFERENCE

A pre-bid conference for this project will be held on **Thursday, March 16, 2017 at 2:30 p.m.** in the **4th Floor Conference Room of Guy C. Larcom City Hall, 301 East Huron Street, Ann Arbor, Michigan.**

Attendance at this conference is highly recommended. Administrative and technical questions regarding this project will be answered at this time. The pre-bid conference is for information only. Any answers furnished will not be official until verified in writing by the Financial Service Area, Procurement Unit. Answers that change or substantially clarify the bid will be affirmed in an addendum.

Street Resurfacing – 2017 (ITB No. 4477) Pre-Bid Conference Summary

March 16, 2017, 2:30 p.m.,
4th Floor South Conference Room, City Hall

I. Introductions

II. General

a. Project Overview

Proposed work is a program larger in size and scope than the 2016 program mainly due to the proposed work on S. Division St. It again will utilize City and County Street/Road Millage funds approved for fiscal years 2017 and 2018 together with other funding sources.

Bid Opening – Project bids are due on Tuesday, March 28, 2018, by 10:00 a.m., and the responsible low bidder and all subcontractors assigned to the Bid must be MDOT Prequalified in order to receive award of the Contract.

b. Standard Specifications and Detailed Specifications

i. Construction Specifications (MDOT 2012 Standard Specifications for Construction)

ii. Project Schedule & Payment

- Starting Date – May 8, 2017
- Completion Date – October 28, 2017
- Project Phasing

There is no particular phasing required of the project and the detailed “Schedule of Streets” shows the proposed work locations and scheduling requirements/restrictions for each. Anticipated minor changes to this schedule are forthcoming. An addendum will address these changes.

- Hours of Work: 7:00 am – 8:00 pm Monday thru Saturday (Sundays w/approval)

iii. General Conditions

Attention was given to this Detailed Specification, and those in attendance work were advised to review its requirements.

iv. Project Supervision

Attention was given to this Detailed Specification, and those in attendance work were advised to review its requirements.

v. NEW PAY ITEM – Certified Payroll Compliance and Reporting

Attention was given to this Detailed Specification, and those in attendance work were advised to review its requirements.

III. Construction

a. Construction Methods and Sequencing

It was noted that all work on Major Streets as part this year’s project will require phased part width construction. The requirements for the construction methods and sequencing related to all locations are noted on the plans. This information is in the process of being updated for release in an addendum. These revisions will address the type of HMA mixes to be used at each location together with other items of work.

Street Resurfacing – 2017 (ITB No. 4477)

Pre-Bid Conference Summary

b. Maintenance of Traffic (M.O.T.)

All work on Major Streets as part this year's project will require maintenance of traffic in one direction only with traffic in the opposite direction operating on posted detours. Detailed M.O.T. plans are included in the plan set, and in the process of being updated with minor changes for release in a future addendum.

c. Special Concerns (local traffic access, pedestrians access, tree protection...)

IV. Addendum Items

No addenda have been issued to date for this project; however, Addendum 1 is expected to be released by Tuesday, March 21, 2017, or Wednesday, March 22, 2017, at the latest unless other necessary revisions are encountered requiring its release be delayed further. This addendum will address changes to the plans regarding incorrect quantity tables, construction keys, construction method and sequencing notes, missing or incorrect detailed specification and special details, and any missing geotechnical information. It was noted that all questions related to the bid are due by 5:00 p.m. Monday, March 20, 2017.

V. Other Items

Attendees were informed that the City is currently working with DTE Energy (Michcon) to replace gas mains on several of the streets proposed as part of this year's project. Major Streets include Arlington Blvd and Miller Rd. Minor Streets include 3rd St, 4th St, 5th St, 6th St, Arella Blvd, W Davis Ave, W Jefferson St, and Wilder Pl. DTE Energy (Michcon) will be required to coordinate this work with the Contractor awarded the project, they have been informed that gas main replacement work must not interfere with or delay that associated with this project.

VI. Questions

- 1. An inconsistency was identified on the S Division St plans between the typical cross sections and the construction methods and sequencing notes related the proposed HMA thickness. This issue will be addressed in an addendum.*
- 2. Concern was expressed with the Detailed Specification for Adjusting Structure Covers and the handling of existing structure covers that are designated for removal from the jobsite. The City will review the requirements of this detailed specification related to this concern and issue any changes in an addendum if necessary.*
- 3. Inconsistencies were identified on the Green Rd Non-motorized Path plans related to the type of proposed HMA material. There was also an inquiry related to a quantity shown for cold milling when this work item was not identified on the plans. These issues will be addressed in an addendum.*
- 4. Concerns were expressed with the use of the City's Special Provision for Acceptance of HMA Mixtures. This special provision will be reviewed further to determine if revisions are required, or if it should be removed from the bid documents and replaced with an alternate.*

Contact Information:

David Dykman
Project Manager
Phone: (734) 794-6410 ext. 43685
Fax: (734) 994-1744
E-mail: ddykman@a2gov.org

PRE-BID CONFERENCE SIGN-IN SHEET

PROJECT: STREET RESURFACING - 2016 (ITB No. 4477)

DATE: 03/16/2017

PLEASE PRINT

NAME	REPRESENTING	MAILING ADDRESS	TELEPHONE	EMAIL
David Dykman Project Manager	City of Ann Arbor - Project Management	Address: 301 E. Huron Street, P.O. Box 8647 City, State: Ann Arbor, MI Zip: 48107-8647	Office: (734) 794-6410, x43685 Mobile: Fax: (734) 994-1744	ddykman@a2gov.org
Gary Shively Civil Engineering Specialist (Project Inspector)	City of Ann Arbor - Project Management	Address: 301 E. Huron Street, P.O. Box 8647 City, State: Ann Arbor, MI Zip: 48107-8647	Office: (734) 794-6410, x43652 Mobile: Fax: (734) 994-1744	gshively@a2gov.org
David Clemons Supervisor - Civil Engineering Specialists	City of Ann Arbor - Project Management	Address: 301 E. Huron Street, P.O. Box 8647 City, State: Ann Arbor, MI Zip: 48107-8647	Office: (734) 794-6410, x43612 Mobile: Fax: (734) 994-1744	dclemons@a2gov.org
JOHN SENKOWSKI	DOAN COMPANIES	Address: 3670 CARPENTER RD City, State: YPSILANTI Zip: 48197	Office: (734) 971 4678 Mobile: (248) 866 0796 Fax No. (734) 971 4415	jsenkowski@doancompanies.com
WANDA DWYER	Wanda CADILLAC	Address: 857 S. WAGNER RD City, State: AZ Zip: 48105	Office: () Mobile: (734) 216-7006 Fax No. ()	WANDA.DWYER@mipmc.com
Rhonda Mosher	Bailey Excavating	Address: 1073 Toro Dr City, State: Jackson MI Zip: 49201	Office: (517) 750-3030 Mobile: () Fax No. (517) 750-1095	jacobbaily@bailey-excavating.com
MIKE ANDREWS	MICHAEL ANDREWS CONCRETE LLC	Address: 7561 CARSON HWY. City, State: Tecumseh MI Zip: 49286	Office: (517) 431-2091 Mobile: (734) 476-2180 Fax No. ()	MIKE ANDREWS CONCRETE@YAHOO.COM
Chris Rachwal	A2	Address: City, State: Zip:	Office: () Mobile: (734) 812-7932 Fax No. ()	C.Rachwal@A2gov.org

INSTRUCTIONS TO BIDDERS

General

Work to be done under this Contract is generally described through the detailed specifications and must be completed fully in accordance with the contract documents. All work to be done under this Contract is located in or near the City of Ann Arbor.

Any Bid which does not conform fully to these instructions may be rejected.

Preparation of Bids

Bids should be prepared providing a straight-forward, concise description of the Bidder's ability to meet the requirements of the ITB. Bids shall be written in ink or typewritten. No erasures are permitted. Mistakes may be crossed out and corrected and must be initialed and dated in ink by the person signing the Bid.

Bids must be submitted on the "Bid Forms" provided with each blank properly filled in. If forms are not fully completed it may disqualify the bid. No alternative bid will be considered unless alternative bids are specifically requested. If alternatives are requested, any deviation from the specification must be fully described, in detail on the "Alternate" section of Bid form.

Each person signing the Bid certifies that he/she is the person in the Bidder's firm/organization responsible for the decision as to the fees being offered in the Bid and has not and will not participated in any action contrary to the terms of this provision.

Questions or Clarification on ITB Specifications

All questions regarding this ITB shall be submitted via email. Emailed questions and inquires will be accepted from any and all prospective Bidders in accordance with the terms and conditions of the ITB.

All questions shall be due on or before **Monday, March 20, 2017 at 5:00 p.m.** and should be addressed as follows:

Specification/Scope of Work questions emailed to **ddykman@a2gov.org**
Bid Process and Compliance questions emailed to **cspencer@a2gov.org**

Any error, omissions or discrepancies in the specification discovered by a prospective contractor and/or service provider shall be brought to the attention of **David Dykman** at **ddykman@a2gov.org** after discovery as possible. Further, the contractor and/or service provide shall not be allowed to take advantage of errors, omissions or discrepancies in the specifications.

Addenda

If it becomes necessary to revise any part of the ITB, notice of the Addendum will be posted to Michigan Inter-governmental Trade Network (MITN) www.mitn.info and/or City of Ann Arbor web

site www.A2gov.org for all parties to download.

Each Bidder must in its Bid, to avoid any miscommunications, acknowledge all addenda which it has received, but the failure of a Bidder to receive, or acknowledge receipt of; any addenda shall not relieve the Bidder of the responsibility for complying with the terms thereof.

The City will not be bound by oral responses to inquiries or written responses other than written addenda.

Bid Submission

All Bids are due and must be delivered to the City of Ann Arbor Procurement Unit on or before **Tuesday, March 28, 2017 by 10:00 a.m.** Bids submitted late or via oral, telephonic, telegraphic, electronic mail or facsimile **will not** be considered or accepted.

Each Bidder must submit one (1) original Bid and one (1) Bid copies in a sealed envelope clearly marked: **ITB No. 4477: Street Resurfacing – 2017.**

Bids must be addressed and delivered to:

City of Ann Arbor
Procurement Unit,
c/o Customer Services, 1st Floor
301 East Huron Street
Ann Arbor, MI 48107

All Bids received on or before the Due Date will be publicly opened and recorded immediately. No immediate decisions are rendered.

The following forms provided within this ITB Document must be included in submitted bids.

- **City of Ann Arbor Prevailing Wage Declaration of Compliance**
- **City of Ann Arbor Living Wage Ordinance Declaration of Compliance**
- **Vendor Conflict of Interest Disclosure Form**
- **City of Ann Arbor Non-Discrimination Ordinance Declaration of Compliance**

Bids that fail to provide these completed forms listed above upon bid opening will be rejected as non-responsive and will not be considered for award.

Hand delivered bids will be date/time stamped/signed by the Procurement Unit at the address above in order to be considered. Normal business hours are 9:00 a.m. to 3:00 p.m. Monday through Friday, excluding Holidays. The City will not be liable to any Bidder for any unforeseen circumstances, delivery or postal delays. Postmarking to the Due Date will not substitute for receipt of the Bid. Each Bidder is responsible for submission of their Bid.

Additional time for submission of bids past the stated due date and time will not be granted to a single Bidder; however, additional time may be granted to all Bidders when the City determines in its sole discretion that circumstances warrant it.

Award

The City intends to award a Contract(s) to the lowest responsible Bidder(s). On multi-divisional contracts, separate divisions may be awarded to separate Bidders. The City may also utilize alternatives offered in the Bid Forms, if any, to determine the lowest responsible Bidder on each division, and award multiple divisions to a single Bidder, so that the lowest total cost is achieved for the City. For unit price bids, the Contract will be awarded based upon the unit prices and the lump sum prices stated by the bidder for the work items specified in the bid documents, with consideration given to any alternates selected by the City. If the City determines that the unit price for any item is materially different for the work item bid than either other bidders or the general market, the City, in its sole discretion, in addition to any other right it may have, may reject the bid as not responsible or non-conforming.

The acceptability of major subcontractors will be considered in determining if a Bidder is responsible. In comparing Bids, the City will give consideration to alternate Bids for items listed in the bid forms. All key staff and subcontractors are subject to the approval by the City.

Official Documents

The City of Ann Arbor officially distributes bid documents from the Procurement Unit or through the Michigan Intergovernmental Trade Network (MITN). Copies of the bid documents obtained from any other source are not Official copies. Addenda and other bid information will only be posted to these official distribution sites. If you obtained City of Ann Arbor Bid documents from other sources, it is recommended that you register on www.MITN.info and obtain an official Bid. Bidders do not need to be shown on the plan holders list provided by MITN to be considered an official plan holder.

Bid Security

Each bid must be accompanied by a certified check, or Bid Bond by a surety licensed and authorized to do business within the State of Michigan, in the amount of 5% of the total of the bid price.

Withdrawal of Bids

After the time of opening, no Bid may be withdrawn for the period of Ninety (90) days

Contract Time

Time is of the essence in the performance of the work under this Contract. The available time for work under this Contract is indicated on page C-2, Article III of the Contract. If these time requirements can not be met, the Bidder must stipulate on Bid Form Section 3 - Time Alternate its schedule for performance of the work. Consideration will be given to time in evaluating bids.

Liquidated Damages

A liquidated damages clause, as given on page C-2, Article III of the Contract, provides that the Contractor shall pay the City as liquidated damages, and not as a penalty, a sum certain per day for each and every day that the Contractor may be in default of completion of the specified work, within the time(s) stated in the Contract, or written extensions.

Liquidated damages clauses, as given in the General Conditions, provide further that the City shall be entitled to impose and recover liquidated damages for breach of the obligations under Chapter 112 of the City Code.

The liquidated damages are for the non-quantifiable aspects of any of the previously identified events and do not cover actual damages that can be shown or quantified nor are they intended to preclude recovery of actual damages in addition to the recovery of liquidated damages.

Human Rights Information

All contractors proposing to do business with the City shall satisfy the contract compliance administrative policy adopted by the City Administrator in accordance with the Section 9:158 of the Ann Arbor City Code. Breach of the obligation not to discriminate as outlined in Section 5, beginning at page GC-3 shall be a material breach of the contract. Contractors are required to post a copy of Ann Arbor's Non-Discrimination Ordinance attached at all work locations where its employees provide services under a contract with the City.

Wage Requirements

Section 4, beginning at page GC-2, outlines the requirements for payment of prevailing wages and for payment of a "living wage" to employees providing service to the City under this contract. The successful bidder and its subcontractors must comply with all applicable requirements and provide proof of compliance.

Pursuant to Resolution R-16-469 all public improvement contractors are subject to prevailing wage and will be required to provide to the City payroll records sufficient to demonstrate compliance with the prevailing wage requirements. Use of the Prevailing Wage Form provided in the Appendix section or a City-approved equivalent will be required along with wage rate interviews.

For laborers whose wage level are subject to federal, state and/or local prevailing wage law the appropriate Davis-Bacon wage rate classification is identified based upon the work including within this contract. **The wage determination(s) current on the date 10 days before bids are due shall apply to this contract.** The U.S. Department of Labor (DOL) has provided explanations to assist with classification in the following resource link: www.wdol.gov

For the purposes of this ITB the Construction Type of Highway will apply.

Conflict Of Interest Disclosure

The City of Ann Arbor Purchasing Policy requires that prospective Vendors complete a Conflict of Interest Disclosure form. A contract may not be awarded to the selected Vendor unless and until the Procurement Unit and the City Administrator have reviewed the Disclosure form and determined that no conflict exists under applicable federal, state, or local law or administrative regulation. Not every relationship or situation disclosed on the Disclosure Form may be a disqualifying conflict. Depending on applicable law and regulations, some contracts may awarded on the recommendation of the City Administrator after full disclosure, where such action is allowed by law, if demonstrated competitive pricing exists and/or it is determined the award is in the best interest of the City. A copy of the Vendor Conflict of Interest Disclosure Form is attached.

Major Subcontractors

The Bidder shall identify on Bid Form Section 4 each major subcontractor it expects to engage for this Contract if the work to be subcontracted is 15% or more of the bid sum or over \$50,000, whichever is less. The Bidder also shall identify the work to be subcontracted to each major subcontractor. The Bidder shall not change or replace a subcontractor without approval by the City.

Debarment

Submission of a Bid in response to this ITB is certification that the Bidder is not currently debarred, suspended, proposed for debarment, and declared ineligible or voluntarily excluded from participation in this transaction by any State or Federal departments or agency. Submission is also agreement that the City will be notified of any changes in this status.

Disclosures

After bids are opened, all information in a submitter's bid is subjected to disclosure under the provisions of Michigan Public Act No. 442 of 1976, as amended (MCL 15.231 et seq.) known as the "Freedom of Information Act." The Freedom of Information Act also provides for the complete disclosure of contracts and attachments thereto except where specifically exempted.

Bid Protest

All Bid protests must be in writing and filed with the Purchasing Agent within five (5) business days of the award action. The bidder must clearly state the reasons for the protest. If a bidder contacts a City Service Area/Unit and indicates a desire to protest an award, the Service Area/Unit shall refer the bidder to the Purchasing Agent. The Purchasing Agent will provide the bidder with the appropriate instructions for filing the protest. The protest shall be reviewed by the City Administrator or designee whose decision shall be final.

Cost Liability

The City of Ann Arbor assumes no responsibility or liability for costs incurred by the Bidder prior to the execution of a contract with the City. By submitting a bid, a bidder agrees to bear all costs incurred or related to the preparation, submission and selection process for the bid.

Reservation of Rights

The City of Ann Arbor reserves the right to accept any bid or alternative bid proposed in whole or in part, to reject any or all bids or alternatives bids in whole or in part and to waive irregularity and/or informalities in any bid and to make the award in any manner deemed in the best interest of the City.

INVITATION TO BID

City of Ann Arbor
Guy C. Larcom Municipal Building
Ann Arbor, Michigan 48107

Ladies and Gentlemen:

The undersigned, as Bidder, declares that this Bid is made in good faith, without fraud or collusion with any person or persons bidding on the same Contract; that this Bidder has carefully read and examined the bid documents, including City Nondiscrimination requirements and Declaration of Compliance Form, Living Wage requirements and Declaration of Compliance Form, Prevailing Wage requirements and Declaration of Compliance Form, Vendor Conflict of Interest Form, Notice of Pre-Bid Conference, Instructions to Bidders, Bid, Bid Forms, Contract, Bond Forms, General Conditions, Standard Specifications, Detailed Specifications, all Addenda, and the Plans (if applicable) and understands them. The Bidder declares that it conducted a full investigation at the site and of the work proposed and is fully informed as to the nature of the work and the conditions relating to the work's performance. The Bidder also declares that it has extensive experience in successfully completing projects similar to this one.

The Bidder acknowledges that it has not received or relied upon any representations or warrants of any nature whatsoever from the City of Ann Arbor, its agents or employees, and that this Bid is based solely upon the Bidder's own independent business judgment.

The undersigned proposes to perform all work shown on the plans or described in the bid documents, including any addenda issued, and to furnish all necessary machinery, tools, apparatus, and other means of construction to do all the work, furnish all the materials, and complete the work in strict accordance with all terms of the Contract of which this Bid is one part.

In accordance with these bid documents, and Addenda numbered 1, 2, 3, 4 the undersigned, as Bidder, proposes to perform at the sites in and/or around Ann Arbor, Michigan, all the work included herein for the amounts set forth in the Bid Forms.

The Bidder declares that it has become fully familiar with the liquidated damage clauses for completion times and for compliance with City Code Chapter 112, understands and agrees that the liquidated damages are for the non-quantifiable aspects of non-compliance and do not cover actual damages that may be shown and agrees that if awarded the Contract, all liquidated damage clauses form part of the Contract.

The Bidder declares that it has become fully familiar with the provisions of Chapter 14, Section 1:320 (Prevailing wages) and Chapter 23 (Living Wage) of the Code of the City of Ann Arbor and that it understands and agrees to comply, to the extent applicable to employees providing services to the City under this Contract, with the wage and reporting requirements stated in the City Code provisions cited. Bidder certifies that the statements contained in the City Prevailing Wage and Living Wage Declaration of Compliance Forms are true and correct. Bidder further agrees that the cited provisions of Chapter 14 and Chapter 23 form a part of this Contract.

The Bidder declares that it has become familiar with the City Conflict of Interest Disclosure Form and certifies that the statement contained therein is true and correct.

The Bidder encloses a certified check or Bid Bond in the amount of 5% of the total of the Bid Price. The Bidder agrees both to contract for the work and to furnish the necessary Bonds and insurance documentation within 10 days after being notified of the acceptance of the Bid.

If this Bid is accepted by the City and the Bidder fails to contract and furnish the required Bonds and insurance documentation within 10 days after being notified of the acceptance of this Bid, then the Bidder shall be considered to have abandoned the Contract and the certified check or Bid Bond accompanying this Bid shall become due and payable to the City.

If the Bidder enters into the Contract in accordance with this Bid, or if this Bid is rejected, then the accompanying check or Bid Bond shall be returned to the Bidder.

In submitting this Bid, it is understood that the right is reserved by the City to accept any Bid, to reject any or all Bids, to waive irregularities and/or informalities in any Bid, and to make the award in any manner the City believes to be in its best interest.

SIGNED THIS 30th DAY OF MARCH, 2017

CADILLAC ASPHALT LLC

Bidder's Name

857 S. WAGNER RD
ANN ARBOR, MI 48103

Official Address

(734) 216-7006

Telephone Number

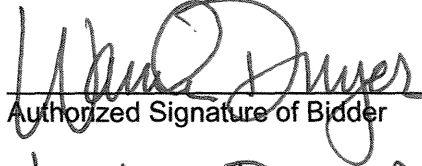

Authorized Signature of Bidder

WANDA DWYER

(Print Name of Signer Above)

WANDA.DWYER@mipmc.com

Email Address for Award Notice

LEGAL STATUS OF BIDDER

(The Bidder shall fill out the appropriate form and strike out the other three.)

Bidder declares that it is:

~~A corporation organized and doing business under the laws of the State of _____, for whom _____, bearing the office title of _____, whose signature is affixed to this Bid, is authorized to execute contracts.~~

~~NOTE: If not incorporated in Michigan, please attach the corporation's Certificate of Authority~~

• A limited liability company doing business under the laws of the State of MICHIGAN whom WANDA DWYER bearing the title of AREA MANAGER whose signature is affixed to this proposal, is authorized to execute contract on behalf of the LLC.

~~* A partnership, organized under the laws of the state of _____ and filed in the county of _____, whose members are (list all members and the street and mailing address of each) (attach separate sheet if necessary):~~

~~_____

_____~~

* An individual, whose signature with address, is affixed to this Bid: _____ (initial here)

Authorized Official

Wanda Dwyer

Date 3/30, 2017

(Print) Name WANDA DWYER Title AREA MANAGER

Company: CADILLAC ASPHALT LLC

Address: 857 S. WAGNER RD, ANN ARBOR, MI 48103

Contact Phone 734 216-7006 Fax 734 662-0439

Email WANDA.DWYER@miPMC.com

ADDENDUM No. 1

ITB No. 4477: Street Resurfacing - 2017

Due: March 30, 2017 at 10:00 a.m. (local time)

The following changes, additions, and/or deletions shall be made to the Invitation to Bid for Street Resurfacing - 2017, ITB No. 4477, on which proposals will be received on/or before March 30, 2017 at 10:00 a.m. (local time).

The information contained herein shall take precedence over the original documents and all previous addenda (if any), and is appended thereto. **This Addendum includes 1 page(s).**

Bidder is to acknowledge receipt of this Addendum No. 1, including all attachments (if any) in its Bid by so indicating on Page ITB-1 of the ITB document. Bids submitted without acknowledgement of receipt of this addendum will be considered nonconforming.

The following forms provided within the ITB document must be included in submitted bids:

- City of Ann Arbor Prevailing Wage Declaration of Compliance
- City of Ann Arbor Living Wage Ordinance Declaration of Compliance
- Vendor Conflict of Interest Disclosure Form
- City of Ann Arbor Non-Discrimination Ordinance Declaration of Compliance

Bids that fail to provide these completed forms listed above upon bid opening will be rejected as non-responsive and will not be considered for award.

I. CORRECTIONS/ADDITIONS/DELETIONS

Changes to the Bid document which are outlined below are referenced to a page or Section in which they appear conspicuously. The Bidder is to take note in its review of the documents and include these changes as they may affect work or details in other areas not specifically referenced here.

<u>Section/Page(s)</u>	<u>Change</u>
All mentions	As provided in ITB No. 4477 Bid Document: Bid Due Date: Tuesday, March 28, 2017 at 10:00 a.m.
	As updated herein: Bid Due Date: Thursday, March 30, 2017 at 10:00 a.m.

Comment: The Due Date and Time for responses to this ITB has been extended to Thursday, March 30, 2017 at 10:00 a.m. (local time). Note that all other dates are unchanged.

Respondents are responsible for any conclusions that they may draw from the information contained in the Addendum.

ADDENDUM No. 2

ITB No. 4477

Street Resurfacing - 2017

Bids Due: March 30, 2017 at 10:00 A.M. (local time)

The following changes, additions, and/or deletions shall be made to the Invitation to Bid for Street Resurfacing - 2017, ITB No. 4477, on which proposals will be received on/or before March 30, 2017, at 10:00 A.M. (local time).

The information contained herein shall take precedence over the original documents and all previous addenda (if any), and is appended thereto. **This Addendum includes 187 pages.**

Bidder is to acknowledge receipt of this Addendum No. 2, including all attachments (if any) in its Bid by so indicating on page ITB-1 of the Invitation to Bid Form. Bids submitted without acknowledgment of receipt of this addendum will be considered nonconforming.

The following forms provided within the ITB Document must be included in submitted bids at bid opening.

- City of Ann Arbor Prevailing Wage Declaration of Compliance
- City of Ann Arbor Living Wage Ordinance Declaration of Compliance
- Vendor Conflict of Interest Disclosure Form
- City of Ann Arbor Non-Discrimination Ordinance Declaration of Compliance

Bids that fail to provide these completed forms listed above upon bid opening will be rejected as non-responsive and will not be considered for award.

I. CORRECTIONS/ADDITIONS/DELETIONS/CLARIFICATIONS

Changes to the Bid documents outlined below are referenced to a page or Section in which they appear conspicuously. The Bidder is to take note in its review of the documents and include these changes as they may affect work or details in other areas not specifically referenced here.

Item #1: Pre-Bid Conference Summary and Attendance Record/Sign-In Sheet pages Addendum-2-4 thru Addendum-2-6.

Item #2: Bid Forms, pages BF-1 thru BF-8; replace these pages with attached pages Addendum-2-7 thru Addendum-2-14.

Item #3: Schedule of Streets pages DS-13 and DS-14; replace with attached pages ADD-2-15 and Addendum-2-16.

Item #4: Insert Detailed Specification for Landscape Boulder page Addendum-2-17.

- Item #5: Insert Detailed Specification for Parking Blocks page Addendum-2-18.
- Item #6: Detailed Specification for Drainage and Utility Structures page DS-26; replace with attached page Addendum-2-19.
- Item #7: Detailed Specification for Adjusting Structure Covers pages DS-29 and DS-30; replace with attached pages Addendum-2-20 and Addendum-2-21.
- Item #8: Detailed Specification for HMA Application Estimate page DS-36; replace with attached page Addendum-2-22.
- Item #9: Insert Detailed Specification for Geosynthetic Paving Layer pages Addendum-2-23 and Addendum-2-24.
- Item #10: Detailed Specification for Concrete Sidewalk, Sidewalk Ramps, and Driveway Approaches pages DS-51 and DS-52; replace with attached pages Addendum-2-25 and Addendum-2-26.
- Item #11: Detailed Specification for Sidewalk Retaining Walls pages DS-53 and DS-55; replace with attached pages Addendum-2-27 and Addendum-2-30.
- Item #12: Insert Detailed Specification for Cast Iron Detectable Warning Surface page Addendum-2-31.
- Item #13 Remove Detailed Specification for Pavement Markings page DS-69.
- Item #14 Insert Specification for Wet Reflective Liquid Applied Pavement Markings pages Addendum-2-32 and Addendum-2-33.
- Item #15 Detailed Specification for Maintenance of Traffic pages DS-70 thru DS-74; replace with attached pages Addendum-2-34 thru Addendum-2-38.
- Item #16 Insert Specification for Temporary Pedestrian Type II Barricade pages Addendum-2-41 and Addendum-2-42.
- Item #17 Insert Specification for Parking Meters pages Addendum-2-39 and Addendum-2-40.
- Item #18: Include in Appendix Notice to Bidders for Parking Meter Removal and Covers page Addendum-2-43.
- Item #19: Remove from Appendix Special Provision for Acceptance of HMA Mixtures, City of Ann Arbor (10 pages).
- Item #20: Include in Appendix Special Provision for Acceptance of Hot Mix Asphalt Mixture on Local Agency Projects pages Addendum-2-44 and Addendum-2-50.
- Item #21: Include in Appendix Special Provision for Hot Mix Asphalt Price for Adjustments page Addendum-2-51.

Item #22: Contract Plan Set; replace Bid issued plan set (sheets 1 thru 136) with that issued for this Addendum 2 (sheets 1 thru 136).

Changes include the following:

Plan Sheets 4, 6, 8, 10, 12, 14, 16, 18, 20, 22, 24, 26, 29, 31, 51, 59, 64, 68, 74, 82, 116, 122 and 133 of 136 (Location Cover Sheets) – Revised QUANTITY TABLE and QUANTITY TABLE for Sign, Type B, Temp, Prismatic to reflect correct pay items and quantities respective to each location, revised CONSTRUCTION METHOD AND SEQUENCING notes to reflect work required at each respective location.

Bidders are responsible for any conclusions that they may draw from the information contained in the Addendum.

ADDENDUM No. 3

ITB No. 4477

Street Resurfacing - 2017

Bids Due: March 30, 2017 at 10:00 A.M. (local time)

The following changes, additions, and/or deletions shall be made to the Invitation to Bid for Street Resurfacing - 2017, ITB No. 4477, on which proposals will be received on/or before March 30, 2017, at 10:00 A.M. (local time).

The information contained herein shall take precedence over the original documents and all previous addenda (if any), and is appended thereto. **This Addendum includes 137 pages.**

Bidder is to acknowledge receipt of this Addendum No. 3, including all attachments (if any) in its Bid by so indicating on page ITB-1 of the Invitation to Bid Form. Bids submitted without acknowledgment of receipt of this addendum will be considered nonconforming.

The following forms provided within the ITB Document must be included in submitted bids at bid opening.

- City of Ann Arbor Prevailing Wage Declaration of Compliance
- City of Ann Arbor Living Wage Ordinance Declaration of Compliance
- Vendor Conflict of Interest Disclosure Form
- City of Ann Arbor Non-Discrimination Ordinance Declaration of Compliance

Bids that fail to provide these completed forms listed above upon bid opening will be rejected as non-responsive and will not be considered for award.

I. CORRECTIONS/ADDITIONS/DELETIONS/CLARIFICATIONS

Changes to the Bid documents outlined below are referenced to a page or Section in which they appear conspicuously. The Bidder is to take note in its review of the documents and include these changes as they may affect work or details in other areas not specifically referenced here.

Item #1: The revised Contract Plan Set mistakenly was not included with Addendum 2; replace the original issued Bid Set dated 03-08-17 (sheets 1 thru 136) with set issued as Addendum 1 dated 03-24-17 (sheets 1 thru 136) and included with this Addendum 3.

Changes include the following:

Plan Sheets 4, 6, 8, 10, 12, 14, 16, 18, 20, 22, 24, 26, 29, 31, 51, 59, 64, 68, 74, 82, 116, 122 and 133 of 136 (Location Cover Sheets) – Revised QUANTITY TABLE and QUANTITY TABLE for Sign, Type B, Temp, Prismatic to reflect correct pay items and quantities respective to each location, revised CONSTRUCTION METHOD AND SEQUENCING notes to reflect work required at each respective location.

Bidders are responsible for any conclusions that they may draw from the information contained in the Addendum.

ADDENDUM No. 4

ITB No. 4477

Street Resurfacing - 2017

UPDATED DUE DATE: April 3, 2017, at 2:00 P.M. (Local Time)

The following changes, additions, and/or deletions shall be made to the Invitation to Bid for Street Resurfacing - 2017, ITB No. 4477, on which proposals are to be received on/or before April 3, 2017, by 2:00 P.M. (Local Time).

The information contained herein shall take precedence over the original documents and all previous addenda (if any), and is appended thereto. **This Addendum includes 2 pages.**

Bidder is to acknowledge receipt of this Addendum No. 4, including all attachments (if any) in its Bid by so indicating on Page ITB-1 of the Invitation to Bid Form. Bids submitted without acknowledgement of receipt of this addendum will be considered nonconforming.

The following forms provided within the ITB Document must be included in submitted bids at bid opening.

- **City of Ann Arbor Prevailing Wage Declaration of Compliance**
- **City of Ann Arbor Living Wage Ordinance Declaration of Compliance**
- **Vendor Conflict of Interest Disclosure Form**
- **City of Ann Arbor Non-Discrimination Ordinance Declaration of Compliance**

Bids that fail to provide these completed forms listed above upon bid opening will be rejected as non-responsive and will not be considered for award.

(This Space Intentionally Left Blank)

I. CORRECTIONS/ADDITIONS/DELETIONS

Changes to the Bid documents which are outlined below are referenced to a page or Section in which they appear conspicuously. The Bidder is to take note in its review of the documents and include these changes as they may affect work or details in other areas not specifically referenced here.

Section/Page(s)

Change

All Mentions

As provided in Addendum 1:
Bid Due Date: Thursday, March 30, 2017, at 10:00 a.m. (Local Time)

As updated herein:
Bid Due Date: Monday, April 3, 2017, at 2:00 p.m. (Local Time)

Comments: *The Due Date and Time for responses to this ITB has been extended to Monday, April 3, 2017, at 2:00 p.m. (local time). Note that all other dates are unchanged.*

Detailed Specifications/
Addendum-2-41 and
Addendum-2-42

Remove Detailed Specification for Temporary Pedestrian Type II Barricade previously included with Addendum 2.

Respondents are responsible for any conclusions that they may draw from the information contained in the Addendum.

BID FORM

Section 1 - Schedule of Prices

Street Resurfacing - 2017
File No. 2017-004
Bid No. 4477

Line No.	Item No.	Item Description	Unit	Estimated Quantity	Unit Price	Total Price
10	1047051	_General Conditions, Max \$75,000.00	LSUM	1.000	\$ 75,000. ⁰⁰	\$ 75,000. ⁰⁰
20	1047051	_Project Supervision, Max \$100,000.00	LSUM	1.000	\$ 100,000. ⁰⁰	\$ 100,000. ⁰⁰
30	1047051	_Certified Payroll Compliance and Reporting	LSUM	1.000	\$ 3,850. ⁰⁰	\$ 3,850. ⁰⁰
40	2030011	Dr Structure, Rem	Ea	82.000	\$ 500. ⁰⁰	\$ 41,000. ⁰⁰
50	2030015	Sewer, Rem, Less than 24 inch	Ft	806.000	\$ 20. ⁰⁰	\$ 16,120. ⁰⁰
60	2047001	_Curb, Gutter, and Curb and Gutter, Any Type, Rem	Ft	7,422.000	\$ 5. ⁵⁰	\$ 40,821. ⁰⁰
70	2047011	_Conc Pavt, Any Thickness, Rem	Syd	1,783.000	\$ 10. ⁰⁰	\$ 17,830. ⁰⁰
80	2047011	_Sidewalk, Sidewalk Ramp, and Driveway Approach, Any Thickness, Rem	Syd	5,021.000	\$ 8. ²⁵	\$ 41,423. ²⁵
90	2047050	_Exploratory Excavation (0-10' Deep) Tr Det I	Ea	11.000	\$ 1,500. ⁰⁰	\$ 16,500. ⁰⁰
100	2047050	_Parking Blocks, Rem	Ea	20.000	\$ 30. ⁰⁰	\$ 600. ⁰⁰
110	2047050	_Landscape Boulder, Rem and Salvage	Ea	60.000	\$ 30. ⁰⁰	\$ 1,800. ⁰⁰
120	2050010	Embankment, CIP	Cyd	239.000	\$ 25. ⁰⁰	\$ 5,975. ⁰⁰
130	2050016	Excavation, Earth	Cyd	303.000	\$ 25. ⁰⁰	\$ 7,575. ⁰⁰
140	2050023	Granular Material, CI II	Cyd	188.000	\$ 25. ⁰⁰	\$ 4,700. ⁰⁰
150	2057011	_Grading, Driveway Approach	Syd	241.000	\$ 3. ⁶⁰	\$ 867. ⁶⁰
160	2057011	_Grading, Sidewalk	Syd	1,255.660	\$ 3. ⁶⁰	\$ 4,520. ³⁸
170	2057011	_Grading, Sidewalk Ramp	Syd	894.330	\$ 3. ⁶⁰	\$ 3,219. ⁵⁹
180	2057011	_Machine Grading, Special	Syd	47,674.440	\$ 3. ³⁰	\$ 157,325. ⁶⁵
190	2057021	_Subgrade Undercutting, Type IIA	Cyd	6,348.000	\$ 37. ⁰⁰	\$ 234,876. ⁰⁰
200	2057021	_Subgrade Undercutting, Type IIB	Cyd	1,500.000	\$ 32. ⁰⁰	\$ 48,000. ⁰⁰
210	2080020	Erosion Control, Inlet Protection, Fabric Drop	Ea	223.000	\$ 100. ⁰⁰	\$ 22,300. ⁰⁰
TOTAL THIS PAGE						\$ 844,303. ⁴⁷

BID FORM

Section 1 - Schedule of Prices

Street Resurfacing - 2017
 File No. 2017-004
 Bid No. 4477

Line No.	Item No.	Item Description	Unit	Estimated Quantity	Unit Price	Total Price
220	2080036	Erosion Control, Silt Fence	Ft	2,500.000	\$ 2.50	\$ 6,250.00
230	2090001	Project Cleanup	LSUM	1.000	\$ 50,000.00	\$ 50,000.00
240	3010002	Subbase, CIP	Cyd	50.000	\$ 25.00	\$ 1,250.00
250	3020001	Aggregate Base	Ton	1,365.000	\$ 20.00	\$ 27,300.00
260	3020050	Aggregate Base, Conditioning	Syd	3,500.000	\$ 2.00	\$ 7,000.00
270	3027011	_Aggregate Base, 8 inch, 21AA	Syd	1,823.000	\$ 13.00	\$ 23,699.00
280	3027021	_Aggregate Base, CIP, 21AA	Cyd	25.000	\$ 60.00	\$ 1,500.00
290	3060020	Maintenance Gravel	Ton	350.000	\$ 22.50	\$ 7,875.00
300	3070001	Approach, CI I	Ton	250.000	\$ 22.00	\$ 5,500.00
310	3070101	Shoulder, CI I	Ton	150.000	\$ 60.00	\$ 9,000.00
320	3080010	Geotextile, Stabilization	Syd	100.000	\$ 5.00	\$ 500.00
330	3087011	_Geosynthetic Paving Layer	Syd	9,929.000	\$ 7.00	\$ 69,503.00
340	4020987	Sewer, CI IV, 12 inch, Tr Det B	Ft	822.000	\$ 90.00	\$ 73,980.00
350	4021260	Trench Undercut and Backfill	Cyd	10.000	\$ 70.00	\$ 700.00
360	4030200	Dr Structure, 24 inch dia	Ea	77.000	\$ 3,200.00	\$ 246,400.00
370	4030210	Dr Structure, 48 inch dia	Ea	12.000	\$ 4,500.00	\$ 54,000.00
380	4030306	Dr Structure, Tap, 6 inch	Ea	5.000	\$ 100.00	\$ 500.00
390	4037001	_Dr Structure, Adj, Add Depth, Modified	Ft	5.000	\$ 150.00	\$ 750.00
400	4037050	_Dr Structure Cover, Special	Ea	1.000	\$ 650.00	\$ 650.00
410	4037050	_Dr Structure Cover, Type B, Modified	Ea	132.000	\$ 550.00	\$ 72,600.00
420	4037050	_Dr Structure Cover, Type D, Modified	Ea	2.000	\$ 550.00	\$ 1,100.00
TOTAL THIS PAGE						\$ 660,057.00

BID FORM

Section 1 - Schedule of Prices

Street Resurfacing - 2017
 File No. 2017-004
 Bid No. 4477

Line No.	Item No.	Item Description	Unit	Estimated Quantity	Unit Price	Total Price
430	4037050	_Dr Structure Cover, Type E, Modified	Ea	2.000	\$ 650. ⁰⁰	\$ 1,300. ⁰⁰
440	4037050	_Dr Structure Cover, Type K, Modified	Ea	84.000	\$ 650. ⁰⁰	\$ 54,600. ⁰⁰
450	4037050	_Dr Structure, Adj, Case 1, Modified	Ea	320.000	\$ 445. ⁰⁰	\$ 142,400. ⁰⁰
460	4037050	_Dr Structure, Adj, Case 2, Modified	Ea	19.000	\$ 445. ⁰⁰	\$ 8,455. ⁰⁰
470	4037050	_Dr Structure, Cleaning, Modified	Ea	25.000	\$ 200. ⁰⁰	\$ 5,000. ⁰⁰
480	4037050	_Dr Structure, Double Inlet	Ea	2.000	\$ 5,000. ⁰⁰	\$ 10,000. ⁰⁰
490	4037050	_Dr Structure, Point	Ea	15.000	\$ 290. ⁰⁰	\$ 4,350. ⁰⁰
500	4037050	_Dr Structure, Reconstruct	Ea	1.000	\$ 1,950. ⁰⁰	\$ 1,950. ⁰⁰
510	4037050	_Dr Structure, Temp Lowering, Modified	Ea	243.000	\$ 350. ⁰⁰	\$ 85,050. ⁰⁰
520	4047001	_Underdrain, Subgrade, 6 inch, Special	Ft	3,000.000	\$ 24. ⁰⁰	\$ 72,000. ⁰⁰
530	5010001	Pavt, Cleaning	LSUM	1.000	\$ 39,550. ⁵³	\$ 39,550. ⁵³
540	5010003	Cold Milling HMA Surface	Ton	23,747.000	\$ 19. ⁵⁰	\$ 463,066. ⁵⁰
550	5010005	HMA Surface, Rem	Syd	3,623.880	\$ 8. ⁰⁰	\$ 28,991. ⁰⁴
560	5010015	Joint and Crack, Cleanout	Ft	2,500.000	\$ 3. ⁰⁰	\$ 7,500. ⁰⁰
570	5010020	Pvmt Joint and Crack Repr, Detail 7	Ft	240.000	\$ 30. ⁰⁰	\$ 7,200. ⁰⁰
580	5010021	Pvmt Joint and Crack Repr, Detail 8	Ft	120.000	\$ 40. ⁰⁰	\$ 4,800. ⁰⁰
590	5010025	Hand Patching	Ton	510.000	\$ 250. ⁰⁰	\$ 127,500. ⁰⁰
600	5010045	HMA, 3E3	Ton	287.000	\$ 130. ⁰⁰	\$ 37,310. ⁰⁰
610	5010051	HMA, 4E3	Ton	1,739.000	\$ 130. ⁰⁰	\$ 226,070. ⁰⁰
620	5010057	HMA, 5E3	Ton	4,153.000	\$ 120. ⁰⁰	\$ 498,360. ⁰⁰
630	5010061	HMA, Approach	Ton	1,134.000	\$ 150. ⁰⁰	\$ 170,100. ⁰⁰
TOTAL THIS PAGE						\$ 1,995,553. ⁰⁷

BID FORM

Section 1 - Schedule of Prices

Street Resurfacing - 2017
File No. 2017-004
Bid No. 4477

Line No.	Item No.	Item Description	Unit	Estimated Quantity	Unit Price	Total Price
640	5010703	HMA, LVSP	Ton	17,146.000	\$ 95. ⁰⁰	\$ 1,628,870. ⁰⁰
650	5017011	_HMA, Raised Crosswalk	Syd	60.000	\$ 95. ⁰⁰	\$ 5,700. ⁰⁰
660	5017011	_HMA, Raised Intersection	Syd	175.000	\$ 95. ⁰⁰	\$ 16,625. ⁰⁰
670	5017011	_HMA, Speed Hump	Syd	35.000	\$ 180. ⁰⁰	\$ 6,300. ⁰⁰
680	5017031	_HMA, Wedging, 36A	Ton	87.000	\$ 400. ⁰⁰	\$ 34,800. ⁰⁰
690	5017031	_Cold Milling for Curb Reveal	Ton	184.000	\$ 110. ⁰⁰	\$ 20,240. ⁰⁰
700	5017050	_HMA Surface, Around Structure Cover, Rem	Ea	123.000	\$ 85. ⁰⁰	\$ 10,455. ⁰⁰
710	6027021	_Flowable Fill	Cyd	226.852	\$ 200. ⁰⁰	\$ 45,370. ⁴⁰
720	6030005	Cement	Ton	24.000	\$ 0. ⁰¹	\$ 0. ²⁴
730	8017011	_Driveway, Nonreinf Conc, 6 inch, Modified	Syd	220.000	\$ 110. ⁰⁰	\$ 24,200. ⁰⁰
740	8017011	_Driveway, Nonreinf Conc, 8 inch, Modified	Syd	37.000	\$ 150. ⁰⁰	\$ 5,550. ⁰⁰
750	8027001	_Curb and Gutter, Conc	Ft	6,112.000	\$ 40. ⁰⁰	\$ 244,480. ⁰⁰
760	8027001	_Driveway Opening, Conc, Det M, Modified	Ft	1,536.500	\$ 40. ⁰⁰	\$ 61,460. ⁰⁰
770	8037001	_Detectable Warning Surface, Modified	Ft	610.000	\$ 32. ⁰⁰	\$ 19,520. ⁰⁰
780	8037001	_Detectable Warning Surface, Cast Iron	Ft	80.000	\$ 50. ⁰⁰	\$ 4,000. ⁰⁰
790	8037001	_Fence, Protective, Modified	Ft	1,250.000	\$ 10. ⁰⁰	\$ 12,500. ⁰⁰
800	8037010	_Sidewalk Ramp, Conc, 6 inch, Modified	Sft	7,092.000	\$ 12. ⁰⁰	\$ 85,104. ⁰⁰
810	8037010	_Sidewalk Retaining Wall, Integral, 6 inch to 18 inch Height	Sft	350.000	\$ 40. ⁰⁰	\$ 14,000. ⁰⁰
820	8037010	_Sidewalk Retaining Wall, Integral, 18 inch to 30 inch Height	Sft	150.000	\$ 40. ⁰⁰	\$ 6,000. ⁰⁰
830	8037010	_Sidewalk, Conc or Clay Brick Pavers, Rem and Reinstall	Sft	70.000	\$ 60. ⁰⁰	\$ 4,200. ⁰⁰
840	8037010	_Sidewalk, Conc, 4 inch, Modified	Sft	5,858.000	\$ 7.75	\$ 45,399. ⁵⁰
TOTAL THIS PAGE						\$ 2,294,774. ¹⁴

BID FORM

Section 1 - Schedule of Prices

Street Resurfacing - 2017
File No. 2017-004
Bid No. 4477

Line No.	Item No.	Item Description	Unit	Estimated Quantity	Unit Price	Total Price
850	8037010	_Sidewalk, Conc, 6 inch, Modified	Sft	307.000	\$ 12. ⁰⁰	\$ 3,684. ⁰⁰
860	8037010	_Sidewalk Ramp, Conc, 8 inch, Modified	Sft	1,058.000	\$ 14. ⁰⁰	\$ 14,812. ⁰⁰
870	8037010	_Sidewalk, Conc, 8 inch, Modified	Sft	3,601.000	\$ 14. ⁰⁰	\$ 50,414. ⁰⁰
880	8050020	Curb Vertical, HMA	Ft	791.000	\$ 15. ⁰⁰	\$ 11,865. ⁰⁰
890	8060040	Shared use Path, HMA	Ton	890.400	\$ 150. ⁰⁰	\$ 133,560. ⁰⁰
900	8110049	Pavt Mrkg, Ovly Cold Plastic, Direction Arrow Sym, Bike	Ea	31.000	\$ 130. ⁰⁰	\$ 4,030. ⁰⁰
910	8110058	Pavt Mrkg, Ovly Cold Plastic, Bike, Small Sym	Ea	29.000	\$ 135. ⁰⁰	\$ 3,915. ⁰⁰
920	8110079	Pavt Mrkg, Ovly Cold Plastic, Sharrow Symbol	Ea	7.000	\$ 360. ⁰⁰	\$ 2,520. ⁰⁰
930	8110520	Pavt Mrkg, Wet Retrflec, Thermopl, 4 inch, White	Ft	16,844.000	\$ 0. ⁹⁰	\$ 15,159. ⁶⁰
940	8110521	Pavt Mrkg, Wet Retrflec, Thermopl, 6 inch, White	Ft	16,919.000	\$ 1. ⁰⁰	\$ 16,919. ⁰⁰
950	8110524	Pavt Mrkg, Wet Retrflec, Thermopl, 4 inch, Yellow	Ft	31,745.000	\$ 0. ⁹⁰	\$ 28,570. ⁵⁰
960	8110332	Rem Raised Pavt Marker	Ea	105.000	\$ 40. ⁰⁰	\$ 4,200. ⁰⁰
970	8110343	Rem Spec Mrkg	Sft	375.000	\$ 3. ⁰⁰	\$ 1,125. ⁰⁰
980	8110450	Recessing Pavement Markings, Longit	Ft	3,127.000	\$ 0. ⁵⁰	\$ 1,563. ⁵⁰
990	8110451	Recessing Pavement Markings, Transv	Sft	2,744.000	\$ 3. ⁰⁰	\$ 8,232. ⁰⁰
1000	8110500	Pavt Mrkg, Wet Retrflec, Polyurea, 4 inch, White	Ft	910.000	\$ 0. ⁹⁰	\$ 819. ⁰⁰
1010	8110501	Pavt Mrkg, Wet Retrflec, Polyurea, 6 inch, White	Ft	1,903.000	\$ 1. ⁰⁰	\$ 1,903. ⁰⁰
1020	8110504	Pavt Mrkg, Wet Retrflec, Polyurea, 4 inch, Yellow	Ft	314.000	\$ 0. ⁹⁰	\$ 282. ⁶⁰
1030	8117001	_Pavt Mrkg, Wet Retrflec, Polyurea, 24 inch, Stop Bar	Ft	403.000	\$ 12. ⁵⁰	\$ 5,037. ⁵⁰
1040	8117001	_Pavt Mrkg, Wet Retrflec, Polyurea, 12 inch, Crosswalk	Ft	1,756.000	\$ 5. ⁵⁰	\$ 9,658. ⁰⁰
1050	8117001	_Pavt Mrkg, Wet Retrflec, Polyurea, 4 inch, Parking Sym, White	Ft	512.000	\$ 2. ⁰⁰	\$ 1,024. ⁰⁰
TOTAL THIS PAGE						\$ 319,293. ⁷⁰

BID FORM

Section 1 - Schedule of Prices

Street Resurfacing - 2017
 File No. 2017-004
 Bid No. 4477

Line No.	Item No.	Item Description	Unit	Estimated Quantity	Unit Price	Total Price
1060	8117001	_Pavt Mrkg, Wet Retrflec, Thermopl, 6 inch, Crosswalk	Ft	2,582.000	\$ 2.50	\$ 6,455.00
1070	8117001	_Pavt Mrkg, Wet Retrflec, Thermopl, 12 inch, Crosswalk	Ft	3,196.000	\$ 5.00	\$ 15,980.00
1080	8117001	_Pavt Mrkg, Wet Retrflec, Thermopl, 12 inch, Cross Hatching, White	Ft	250.000	\$ 5.00	\$ 1,250.00
1090	8117001	_Pavt Mrkg, Wet Retrflec, Thermopl, 12 inch, Cross Hatching, Yellow	Ft	125.000	\$ 5.00	\$ 625.00
1100	8117001	_Pavt Mrkg, Wet Retrflec, Thermopl, 24 inch, Stop Bar	Ft	1,440.000	\$ 11.50	\$ 16,560.00
1110	8117001	_Pavt Mrkg, Wet Retrflec, Thermopl, 4 inch, Parking Sym, White	Ft	1,024.000	\$ 2.00	\$ 2,048.00
1120	8117050	_Pavt Mrkg, Wet Retrflec, Polyurea, Lt Turn Arrow Sym	Ea	2.000	\$ 170.00	\$ 340.00
1130	8117050	_Pavt Mrkg, Wet Retrflec, Polyurea, Only	Ea	4.000	\$ 170.00	\$ 680.00
1140	8117050	_Pavt Mrkg, Wet Retrflec, Polyurea, Rt Turn Arrow Sym	Ea	1.000	\$ 170.00	\$ 170.00
1150	8117050	_Pavt Mrkg, Wet Retrflec, Polyurea, Thru Arrow Sym	Ea	1.000	\$ 160.00	\$ 160.00
1160	8117050	_Pavt Mrkg, Wet Retrflec, Thermopl, Lt Turn Arrow Sym	Ea	14.000	\$ 160.00	\$ 2,240.00
1170	8117050	_Pavt Mrkg, Wet Retrflec, Thermopl, Rt Turn Arrow Sym	Ea	7.000	\$ 160.00	\$ 1,120.00
1180	8117050	_Pavt Mrkg, Wet Retrflec, Thermopl, Thru and Rt Turn Arrow Sym	Ea	5.000	\$ 225.00	\$ 1,125.00
1190	8117050	_Pavt Mrkg, Wet Retrflec, Thermopl, Thru and Lt Turn Arrow Sym	Ea	5.000	\$ 225.00	\$ 1,125.00
1200	8117050	_Pavt Mrkg, Wet Retrflec, Thermopl, Only	Ea	18.000	\$ 160.00	\$ 2,880.00
1210	8117050	_Pavt Mrkg, Wet Retrflec, Thermopl, School	Ea	6.000	\$ 250.00	\$ 1,500.00
1220	8117050	_Pavt Mrkg, Wet Retrflec, Thermopl, Railroad Sym	Ea	2.000	\$ 400.00	\$ 800.00
1230	8117050	_Pavt Mrkg, Wet Retrflec, Thermopl, Speed Hump Chevron, White	Ea	1.000	\$ 400.00	\$ 400.00
1240	8120012	Barricade, Type III, High Intensity, Double Sided, Lighted, Furn	Ea	145.000	\$ 65.00	\$ 9,425.00
1250	8120013	Barricade, Type III, High Intensity, Double Sided, Lighted, Oper	Ea	145.000	\$ 65.00	\$ 9,425.00
1260	8120030	Channelizing Device, 42 inch, Furn	Ea	500.000	\$ 20.00	\$ 10,000.00
TOTAL THIS PAGE						\$ 84,308.00

BID FORM

Section 1 - Schedule of Prices

Street Resurfacing - 2017
 File No. 2017-004
 Bid No. 4477

Line No.	Item No.	Item Description	Unit	Estimated Quantity	Unit Price	Total Price
1270	8120031	Channelizing Device, 42 inch, Oper	Ea	500.000	\$ 20. ⁰⁰	\$ 10,000. ⁰⁰
1280	8120140	Lighted Arrow, Type C, Furn	Ea	22.000	\$ 700. ⁰⁰	\$ 15,400. ⁰⁰
1290	8120141	Lighted Arrow, Type C, Oper	Ea	16.000	\$ 700. ⁰⁰	\$ 11,200. ⁰⁰
1300	8120210	Pavt Mrkg, Longit, 6 inch or Less Width, Rem	Ft	250.000	\$ 1. ⁰⁰	\$ 250. ⁰⁰
1310	8120235	Pavt Mrkg, Wet Retrlec, Type NR, Paint, 4 inch, White, Temp	Ft	2,500.000	\$ 0.40	\$ 1,000. ⁰⁰
1320	8120236	Pavt Mrkg, Wet Retrlec, Type NR, Paint, 4 inch, Yellow, Temp	Ft	7,500.000	\$ 0.40	\$ 3,000. ⁰⁰
1330	8120245	Pavt Mrkg, Wet Retrlec, Type R, Tape, 4 inch, White, Temp	Ft	2,760.000	\$ 1.60	\$ 4,416. ⁰⁰
1340	8120246	Pavt Mrkg, Wet Retrlec, Type R, Tape, 4 inch, Yellow, Temp	Ft	2,000.000	\$ 1.60	\$ 3,200. ⁰⁰
1350	8120260	Plastic Drum, High Intensity, Lighted, Furn	Ea	1,644.000	\$ 25. ⁰⁰	\$ 41,100. ⁰⁰
1360	8120261	Plastic Drum, High Intensity, Lighted, Oper	Ea	1,644.000	\$ 25. ⁰⁰	\$ 41,100. ⁰⁰
1370	8120310	Sign Cover	Ea	50.000	\$ 40. ⁰⁰	\$ 2,000. ⁰⁰
1380	8120330	Sign, Portable, Changeable Message, Furn	Ea	12.000	\$ 4,200. ⁰⁰	\$ 50,400. ⁰⁰
1390	8120331	Sign, Portable, Changeable Message, Oper	Ea	25.000	\$ 1,500. ⁰⁰	\$ 37,500. ⁰⁰
1400	8120350	Sign, Type B, Temp, Prismatic, Furn	Sft	6,460.500	\$ 2.50	\$ 16,151. ²⁵
1410	8120351	Sign, Type B, Temp, Prismatic, Oper	Sft	6,460.500	\$ 2.50	\$ 16,151. ²⁵
1420	8120370	Traf Regulator Control	LSUM	1.000	\$ 19,850. ⁰⁰	\$ 19,850. ⁰⁰
1430	8127050	_No Parking Sign	Ea	451.000	\$ 35. ⁰⁰	\$ 15,785. ⁰⁰
1440	8127051	_Minor Traffic Control, Max \$50,000.00	LSUM	1.000	\$ 50,000. ⁰⁰	\$ 50,000. ⁰⁰
1450	8157060	_Irrigation System, Protection and Maintenance	Dir	2,500.000	\$ 1. ⁰⁰	\$ 2,500. ⁰⁰
1460	8167011	_Slope Restoration	Syd	5,514.280	\$ 4. ⁰⁰	\$ 22,057. ¹²
1470	8190159	Conduit, Schedule 80, 3 inch	Ft	100.000	\$ 20. ⁰⁰	\$ 2,000. ⁰⁰
TOTAL THIS PAGE						\$ 365,060. ⁶²

BID FORM

Section 1 - Schedule of Prices

Street Resurfacing - 2017
File No. 2017-004
Bid No. 4477

Line No.	Item No.	Item Description	Unit	Estimated Quantity	Unit Price	Total Price
1480	8197050	_Handhole Assembly, 12 Inch x 18 Inch	Ea	2.000	\$ <u>1,000.⁰⁰</u>	\$ <u>2,000.⁰⁰</u>
1490	8197050	_Handhole Assembly, 17 Inch x 30 Inch	Ea	2.000	\$ <u>1,400.⁰⁰</u>	\$ <u>2,800.⁰⁰</u>
1500	8197050	_Handhole Assembly, 24 inch x 36 inch	Ea	2.000	\$ <u>2,000.⁰⁰</u>	\$ <u>4,000.⁰⁰</u>
1510	8217050	_Monument Box Adjust	Ea	12.000	\$ <u>420.⁰⁰</u>	\$ <u>5,040.⁰⁰</u>
1520	8230431	Gate Box, Adj, Case 1	Ea	52.000	\$ <u>420.⁰⁰</u>	\$ <u>21,840.⁰⁰</u>
1530	8230432	Gate Box, Adj, Case 2	Ea	1.000	\$ <u>420.⁰⁰</u>	\$ <u>420.⁰⁰</u>
1540	8257050	_Remove Parking Meters	Ea	18.000	\$ <u>100.⁰⁰</u>	\$ <u>1,800.⁰⁰</u>
1550	8257050	_Install Parking Meters	Ea	14.000	\$ <u>250.⁰⁰</u>	\$ <u>3,500.⁰⁰</u>
TOTAL THIS PAGE						\$ <u>41,400.⁰⁰</u>
TOTAL FROM PAGE BF-1						\$ <u>844,303.47</u>
TOTAL FROM PAGE BF-2						\$ <u>660,057.⁰⁰</u>
TOTAL FROM PAGE BF-3						\$ <u>1,995,553.67</u>
TOTAL FROM PAGE BF-4						\$ <u>2,294,774.14</u>
TOTAL FROM PAGE BF-5						\$ <u>319,293.⁷⁰</u>
TOTAL FROM PAGE BF-6						\$ <u>84,308.⁰⁰</u>
TOTAL FROM PAGE BF-7						\$ <u>365,060.⁶²</u>
TOTAL BASE BID						\$ <u>6,604,750.⁰⁰</u>

BID FORM

Section 2 - Material and Equipment Alternates

The Base Bid proposal price shall include materials and equipment selected from the designated items and manufacturers listed in the bidding documents. This is done to establish uniformity in bidding and to establish standards of quality for the items named.

If the Contractor wishes to quote alternate items for consideration by the City, it may do so under this Section. A complete description of the item and the proposed price differential must be provided. Unless approved at the time of award, substitutions where items are specifically named will be considered only as a negotiated change in Contract Sum.

<u>Item Number</u>	<u>Description</u>	<u>Add/Deduct Amount</u>
--------------------	--------------------	--------------------------

If the Bidder does not suggest any material or equipment alternate, the Bidder **MUST** complete the following statement:

For the work outlined in this request for bid, the bidder does NOT propose any material or equipment alternate under the Contract.

Signature of Authorized Representative of Bidder

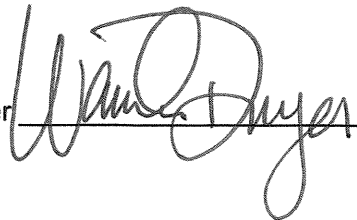

Date

3/30/17

BID FORM

Section 3 - Time Alternate

If the Bidder takes exception to the time stipulated in Article III of the Contract, Time of Completion, page C-2, it is requested to stipulate below its proposed time for performance of the work. Consideration will be given to time in evaluating bids.

If the Bidder does not suggest any time alternate, the Bidder **MUST** complete the following statement:

For the work outlined in this request for bid, the bidder does NOT propose any time alternate under the Contract.

Signature of Authorized Representative of Bidder

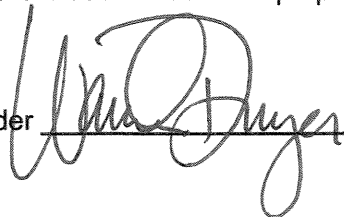
 Date 3/30/17

BID FORM

Section 4 - Major Subcontractors

For purposes of this Contract, a Subcontractor is anyone (other than the Contractor) who performs work (other than or in addition to the furnishing of materials, plans or equipment) at or about the construction site, directly or indirectly for or on behalf of the Contractor (and whether or not in privity of Contract with the Contractor), but shall not include any individual who furnishes merely the individual's own personal labor or services.

Contractor agrees that all subcontracts entered into by the Contractor shall contain similar wage provision to Section 4 of the General Conditions covering subcontractor's employees who perform work on this contract.

For the work outlined in these documents the Bidder expects to engage the following major subcontractors to perform the work identified:

<u>Subcontractor (Name and Address)</u>	<u>Work</u>	<u>Amount</u>	
- DAN CONSTRUCTION 3670 CARPENTER RD YPSILANTI, MI 48197	CONCRETE	\$850,000.	00
- MICHAEL ANDREWS CONCRETE 9561 CARSON HWY TECUMSEH, MI 49286	STRUCTURES	\$960,000.	00
- PK Contracting 1965 Barrett Dr Troy, MI 48084	STRIPING	\$220,000.	08
- MILLER BROTHERS INC. 161 S. DEFIANCE ST. ARCHIBALD, OH 43502	MILLING	\$520,000.	00

If the Bidder does not expect to engage any major subcontractor, the Bidder **MUST** complete the following statement:

For the work outlined in this request for bid, the bidder does NOT expect to engage any major subcontractor to perform work under the Contract.

Signature of Authorized Representative of Bidder _____ Date _____

BID FORM

Section 5 – References

Include a minimum of ___ reference from similar project completed within the past ___ years.

[Refer also to Instructions to Bidders for additional requirements, if any]

1) Ann Arbor 2016 Resurfacing \$5,558,387.⁹³ MAY - OCT, 2016
Project Name Cost Date Constructed

DANE DYKMAN
Contact Name

(734) 645-6560
Phone Number

2) WASHTENAW COUNTY OVERLAY \$2,770,735.⁰⁰ MAY - NOV, 2016
Project Name Cost Date Constructed

MIKE BERNBECK / JIM HARMON
Contact Name

(734) 761-1500
Phone Number

3) Central City Pkwy \$1,472,400.19 9/16/16
Project Name Cost Date Constructed

Craig Dashner, OTHM
Contact Name

(248) 568-9610
Phone Number

THIS PAGE
INTENTIONALLY
LEFT BLANK

CONTRACT

THIS AGREEMENT is made on the 1st day of May, 2017, between the CITY OF ANN ARBOR, a Michigan Municipal Corporation, 301 East Huron Street, Ann Arbor, Michigan 48104 ("City") and Cadillac Asphalt LLC ("Contractor") a State of Michigan Corporation located at 857 South Wagner Road, Ann Arbor, MI, 48103.

Based upon the mutual promises below, the Contractor and the City agree as follows:

ARTICLE I - Scope of Work

The Contractor agrees to furnish all of the materials, equipment and labor necessary; and to abide by all the duties and responsibilities applicable to it for the project titled "**Street Resurfacing - 2017**" in accordance with the requirements and provisions of the following documents, including all written modifications incorporated into any of the documents, which are incorporated as part of this Contract:

Living Wage and Non-Discrimination Ordinances -Declaration of Compliance Forms (if applicable)	Bonds
Vendor Conflict of Interest Form	General Conditions
Prevailing Wage Declaration of Compliance Form (if applicable)	Standard Specifications
Bid Forms	Detailed Specifications
Contract and Exhibits	Plans
	Addenda

ARTICLE II - Definitions

Administering Service Area/Unit means **Public Services Area /Project Management Services Unit**

Project means **Street Resurfacing – 2017; ITB No. 4477**

ARTICLE III - Time of Completion

- (A) The work to be completed under this Contract shall begin in accordance with the "Detailed Specification for Project Schedule" contained elsewhere herein and only after the Contractor's receipt of a fully executed Contract and Notice to Proceed issued by the City.
- (B) The entire work for this Contract shall be completed by October 28, 2017. Intermediate completion dates, restricted dates, intermediate durations for completing work, and other special requirements for certain portions of the project are specified in the "Detailed Specification for Project Schedule".
- (C) Failure to complete all the work within the time specified above, including any extension granted in writing by the Supervising Professional, shall obligate the Contractor to pay the City, as liquidated damages and not as a penalty, the amount(s) specified in the "Detailed Specification for Project Schedule" found on page DS-1 of the Contract Documents for each calendar day of delay in the completion of all the work. If any liquidated damages are unpaid by the Contractor, the City shall be entitled to deduct these unpaid liquidated damages from the monies due the Contractor.

The liquidated damages are for the non-quantifiable aspects of any of the previously identified events and do not cover actual damages that can be shown or quantified nor are they intended to preclude recovery of actual damages in addition to the recovery of liquidated damages.

ARTICLE IV - The Contract Sum

- (A) The City shall pay to the Contractor for the performance of the Contract, the unit prices as given in the Bid Form for the estimated bid total of:

Six Million Six Hundred Four Thousand Seven Hundred Fifty and 00/100 Dollars
(\$6,604,750.00)

- (B) The amount paid shall be equitably adjusted to cover changes in the work ordered by the Supervising Professional but not required by the Contract Documents. Increases or decreases shall be determined only by written agreement between the City and Contractor.

ARTICLE V - Assignment

This Contract may not be assigned or subcontracted any portion of any right or obligation under this contract without the written consent of the City. Notwithstanding any consent by the City to any assignment, Contractor shall at all times remain bound to all warranties, certifications, indemnifications, promises and performances, however described, as are required of it under this contract unless specifically released from the requirement, in writing, by the City.

ARTICLE VI - Choice of Law

This Contract shall be construed, governed, and enforced in accordance with the laws of the State of Michigan. By executing this agreement, the Contractor and the City agree to venue in a court of appropriate jurisdiction sitting within Washtenaw County for purposes of any action arising under this Contract. The parties stipulate that the venue referenced in this Contract is for convenience and waive any claim of non-convenience.

Whenever possible, each provision of the Contract will be interpreted in a manner as to be effective and valid under applicable law. The prohibition or invalidity, under applicable law, of any provision will not invalidate the remainder of the Contract.

ARTICLE VII - Relationship of the Parties

The parties of the Contract agree that it is not a Contract of employment but is a Contract to accomplish a specific result. Contractor is an independent Contractor performing services for the City. Nothing contained in this Contract shall be deemed to constitute any other relationship between the City and the Contractor.

Contractor certifies that it has no personal or financial interest in the project other than the compensation it is to receive under the Contract. Contractor certifies that it is not, and shall not become, overdue or in default to the City for any Contract, debt, or any other obligation to the City including real or personal property taxes. City shall have the right to set off any such debt against compensation awarded for services under this agreement.

ARTICLE VIII - Notice

All notices given under this Contract shall be in writing, and shall be by personal delivery or by certified mail with return receipt requested to the parties at their respective addresses as specified in the Contract Documents or other address the Contractor may specify in writing.

Notice will be deemed given on the date when one of the following first occur: (1) the date of actual receipt; or (2) three days after mailing certified U.S. mail.

ARTICLE IX - Indemnification

To the fullest extent permitted by law, Contractor shall indemnify, defend and hold harmless the City, its officers, employees and agents harmless from all suits, claims, judgments and expenses including attorney's fees resulting or alleged to result, in whole or in part, from any act or omission, which is in any way connected or associated with this Contract, by the Contractor or anyone acting on the Contractor's behalf under this Contract. Contractor shall not be responsible to indemnify the City for losses or damages caused by or resulting from the City's sole negligence. The provisions of this Article shall survive the expiration or earlier termination of this contract for any reason.

ARTICLE X - Entire Agreement

This Contract represents the entire understanding between the City and the Contractor and it supersedes all prior representations, negotiations, agreements, or understandings whether written or oral. Neither party has relied on any prior representations in entering into this Contract. No terms or conditions of either party's invoice, purchase order or other administrative document shall modify the terms and conditions of this Contract, regardless of the other party's failure to object to such form. This Contract shall be binding on and shall inure to the benefit of the parties to this Contract and their permitted successors and permitted assigns and nothing in this Contract, express or implied, is intended to or shall confer on any other person or entity any legal or equitable right, benefit, or remedy of any nature whatsoever under or by reason of this Contract. This Contract may be altered, amended or modified only by written amendment signed by the City and the Contractor.

FOR CONTRACTOR

By _____

Its: _____

FOR THE CITY OF ANN ARBOR

By _____

Christopher Taylor, Mayor

By _____

Jacqueline Beaudry, City Clerk

Approved as to substance

By _____

Howard S. Lazarus, City Administrator

By _____

Craig Hupy, P.E., Public Services Area Administrator

Approved as to form and content

By _____

Stephen K. Postema, City Attorney

PERFORMANCE BOND

- (1) _____(referred to as "Principal"), and _____, a corporation duly authorized to do business in the State of Michigan (referred to as "Surety"), are bound to the City of Ann Arbor, Michigan (referred to as "City"), for
- \$ _____, the payment of which Principal and Surety bind themselves, their heirs, executors, administrators, successors and assigns, jointly and severally, by this bond.
- (2) The Principal has entered a written Contract with the City dated _____, 201_, for: _____ and this bond is given for that Contract in compliance with Act No. 213 of the Michigan Public Acts of 1963, as amended, being MCL 129.201 et seq.
- (3) Whenever the Principal is declared by the City to be in default under the Contract, the Surety may promptly remedy the default or shall promptly:
- (a) complete the Contract in accordance with its terms and conditions; or
 - (b) obtain a bid or bids for submission to the City for completing the Contract in accordance with its terms and conditions, and upon determination by Surety of the lowest responsible bidder, arrange for a Contract between such bidder and the City, and make available, as work progresses, sufficient funds to pay the cost of completion less the balance of the Contract price; but not exceeding, including other costs and damages for which Surety may be liable hereunder, the amount set forth in paragraph 1.
- (4) Surety shall have no obligation to the City if the Principal fully and promptly performs under the Contract.
- (5) Surety agrees that no change, extension of time, alteration or addition to the terms of the Contract or to the work to be performed thereunder, or the specifications accompanying it shall in any way affect its obligations on this bond, and waives notice of any such change, extension of time, alteration or addition to the terms of the Contract or to the work, or to the specifications.

SIGNED AND SEALED this _____ day of _____, 201_.

(Name of Surety Company)

By _____
(Signature)

Its _____
(Title of Office)

Approved as to form:

Stephen K. Postema, City Attorney

(Name of Principal)

By _____
(Signature)

Its _____
(Title of Office)

Name and address of agent:

LABOR AND MATERIAL BOND

- (1) _____
of _____(referred to as "Principal"), and _____, a corporation duly authorized to do business in the State of Michigan, (referred to as "Surety"), are bound to the City of Ann Arbor, Michigan (referred to as "City"), for the use and benefit of claimants as defined in Act 213 of Michigan Public Acts of 1963, as amended, being MCL 129.201 et seq., in the amount of \$ _____, for the payment of which Principal and Surety bind themselves, their heirs, executors, administrators, successors and assigns, jointly and severally, by this bond.
- (2) The Principal has entered a written Contract with the City, dated _____, 201_, for _____; and this bond is given for that Contract in compliance with Act No. 213 of the Michigan Public Acts of 1963 as amended;
- (3) If the Principal fails to promptly and fully repay claimants for labor and material reasonably required under the Contract, the Surety shall pay those claimants.
- (4) Surety's obligations shall not exceed the amount stated in paragraph 1, and Surety shall have no obligation if the Principal promptly and fully pays the claimants.

SIGNED AND SEALED this _____ day of _____, 201_

(Name of Surety Company)
By _____
(Signature)
Its _____
(Title of Office)

(Name of Principal)
By _____
(Signature)
Its _____
(Title of Office)

Approved as to form:

Stephen K. Postema, City Attorney

Name and address of agent:

GENERAL CONDITIONS

Section 1 - Execution, Correlation and Intent of Documents

The contract documents shall be signed in 2 copies by the City and the Contractor.

The contract documents are complementary and what is called for by any one shall be binding. The intention of the documents is to include all labor and materials, equipment and transportation necessary for the proper execution of the work. Materials or work described in words which so applied have a well-known technical or trade meaning have the meaning of those recognized standards.

In case of a conflict among the contract documents listed below in any requirement(s), the requirement(s) of the document listed first shall prevail over any conflicting requirement(s) of a document listed later.

(1) Addenda in reverse chronological order; (2) Detailed Specifications; (3) Standard Specifications; (4) Plans; (5) General Conditions; (6) Contract; (7) Bid Forms; (8) Bond Forms; (9) Bid.

Section 2 - Order of Completion

The Contractor shall submit with each invoice, and at other times reasonably requested by the Supervising Professional, schedules showing the order in which the Contractor proposes to carry on the work. They shall include the dates at which the Contractor will start the several parts of the work, the estimated dates of completion of the several parts, and important milestones within the several parts.

Section 3 - Familiarity with Work

The Bidder or its representative shall make personal investigations of the site of the work and of existing structures and shall determine to its own satisfaction the conditions to be encountered, the nature of the ground, the difficulties involved, and all other factors affecting the work proposed under this Contract. The Bidder to whom this Contract is awarded will not be entitled to any additional compensation unless conditions are clearly different from those which could reasonably have been anticipated by a person making diligent and thorough investigation of the site.

The Bidder shall immediately notify the City upon discovery, and in every case prior to submitting its Bid, of every error or omission in the bidding documents that would be identified by a reasonably competent, diligent Bidder. In no case will a Bidder be allowed the benefit of extra compensation or time to complete the work under this Contract for extra expenses or time spent as a result of the error or omission.

Section 4 - Wage Requirements

Under this Contract, the Contractor shall conform to Chapter 14 of Title I of the Code of the City of Ann Arbor as amended; which in part states "...that all craftsmen, mechanics and laborers employed directly on the site in connection with said improvements, including said employees of

subcontractors, shall receive the prevailing wage for the corresponding classes of craftsmen, mechanics and laborers, as determined by statistics for the Ann Arbor area compiled by the United States Department of Labor. At the request of the City, any contractor or subcontractor shall provide satisfactory proof of compliance with the contract provisions required by the Section."

Pursuant to Resolution R-16-469 all public improvement contractors are subject to prevailing wage and will be required to provide to the City payroll records sufficient to demonstrate compliance with the prevailing wage requirements. A sample Prevailing Wage Form is provided in the Appendix herein for reference as to what will be expected from contractors. Use of the Prevailing Wage Form provided in the Appendix section or a City-approved equivalent will be required along with wage rate interviews.

Where the Contract and the Ann Arbor City Ordinance are silent as to definitions of terms required in determining contract compliance with regard to prevailing wages, the definitions provided in the Davis-Bacon Act as amended (40 U.S.C. 278-a to 276-a-7) for the terms shall be used.

If the Contractor is a "covered employer" as defined in Chapter 23 of the Ann Arbor City Code, the Contractor agrees to comply with the living wage provisions of Chapter 23 of the Ann Arbor City Code. The Contractor agrees to pay those employees providing Services to the City under this Agreement a "living wage," as defined in Section 1:815 of the Ann Arbor City Code, as adjusted in accordance with Section 1:815(3); to post a notice approved by the City of the applicability of Chapter 23 in every location in which regular or contract employees providing services under this Agreement are working; to maintain records of compliance; if requested by the City, to provide documentation to verify compliance; to take no action that would reduce the compensation, wages, fringe benefits, or leave available to any employee or person contracted for employment in order to pay the living wage required by Section 1:815; and otherwise to comply with the requirements of Chapter 23.

Contractor agrees that all subcontracts entered into by the Contractor shall contain similar wage provision covering subcontractor's employees who perform work on this contract.

Section 5 - Non-Discrimination

The Contractor agrees to comply, and to require its subcontractor(s) to comply, with the nondiscrimination provisions of MCL 37.2209. The Contractor further agrees to comply with the provisions of Section 9:158 of Chapter 112 of Title IX of the Ann Arbor City Code, and to assure that applicants are employed and that employees are treated during employment in a manner which provides equal employment opportunity.

Section 6 - Materials, Appliances, Employees

Unless otherwise stipulated, the Contractor shall provide and pay for all materials, labor, water, tools, equipment, light, power, transportation, and other facilities necessary or used for the execution and completion of the work. Unless otherwise specified, all materials incorporated in the permanent work shall be new, and both workmanship and materials shall be of the highest quality. The Contractor shall, if required, furnish satisfactory evidence as to the kind and quality of materials.

The Contractor shall at all times enforce strict discipline and good order among its employees, and shall seek to avoid employing on the work any unfit person or anyone not skilled in the work assigned.

Adequate sanitary facilities shall be provided by the Contractor.

Section 7 - Qualifications for Employment

The Contractor shall employ competent laborers and mechanics for the work under this Contract. For work performed under this Contract, employment preference shall be given to qualified local residents.

Section 8 - Royalties and Patents

The Contractor shall pay all royalties and license fees. It shall defend all suits or claims for infringements of any patent rights and shall hold the City harmless from loss on account of infringement except that the City shall be responsible for all infringement loss when a particular process or the product of a particular manufacturer or manufacturers is specified, unless the City has notified the Contractor prior to the signing of the Contract that the particular process or product is patented or is believed to be patented.

Section 9 - Permits and Regulations

The Contractor must secure and pay for all permits, permit or plan review fees and licenses necessary for the prosecution of the work. These include but are not limited to City building permits, right-of-way permits, lane closure permits, right-of-way occupancy permits, and the like. The City shall secure and pay for easements shown on the plans unless otherwise specified.

The Contractor shall give all notices and comply with all laws, ordinances, rules and regulations bearing on the conduct of the work as drawn and specified. If the Contractor observes that the contract documents are at variance with those requirements, it shall promptly notify the Supervising Professional in writing, and any necessary changes shall be adjusted as provided in the Contract for changes in the work.

Section 10 - Protection of the Public and of Work and Property

The Contractor is responsible for the means, methods, sequences, techniques and procedures of construction and safety programs associated with the work contemplated by this contract. The Contractor, its agents or sub-contractors, shall comply with the "General Rules and Regulations for the Construction Industry" as published by the Construction Safety Commission of the State of Michigan and to all other local, State and National laws, ordinances, rules and regulations pertaining to safety of persons and property.

The Contractor shall take all necessary and reasonable precautions to protect the safety of the public. It shall continuously maintain adequate protection of all work from damage, and shall take all necessary and reasonable precautions to adequately protect all public and private property from injury or loss arising in connection with this Contract. It shall make good any damage, injury or loss to its work and to public and private property resulting from lack of reasonable protective precautions, except as may be due to errors in the contract documents, or caused by agents or employees of the City. The Contractor shall obtain and maintain sufficient insurance to cover damage to any City property at the site by any cause.

In an emergency affecting the safety of life, or the work, or of adjoining property, the Contractor is, without special instructions or authorization from the Supervising Professional, permitted to act at its discretion to prevent the threatened loss or injury. It shall also so act, without appeal, if authorized or instructed by the Supervising Professional.

Any compensation claimed by the Contractor for emergency work shall be determined by agreement or in accordance with the terms of Claims for Extra Cost - Section 15.

Section 11 - Inspection of Work

The City shall provide sufficient competent personnel for the inspection of the work.

The Supervising Professional shall at all times have access to the work whenever it is in preparation or progress, and the Contractor shall provide proper facilities for access and for inspection.

If the specifications, the Supervising Professional's instructions, laws, ordinances, or any public authority require any work to be specially tested or approved, the Contractor shall give the Supervising Professional timely notice of its readiness for inspection, and if the inspection is by an authority other than the Supervising Professional, of the date fixed for the inspection. Inspections by the Supervising Professional shall be made promptly, and where practicable at the source of supply. If any work should be covered up without approval or consent of the Supervising Professional, it must, if required by the Supervising Professional, be uncovered for examination and properly restored at the Contractor's expense.

Re-examination of any work may be ordered by the Supervising Professional, and, if so ordered, the work must be uncovered by the Contractor. If the work is found to be in accordance with the contract documents, the City shall pay the cost of re-examination and replacement. If the work is not in accordance with the contract documents, the Contractor shall pay the cost.

Section 12 - Superintendence

The Contractor shall keep on the work site, during its progress, a competent superintendent and any necessary assistants, all satisfactory to the Supervising Professional. The superintendent will be responsible to perform all on-site project management for the Contractor. The superintendent shall be experienced in the work required for this Contract. The superintendent shall represent the Contractor and all direction given to the superintendent shall be binding as if given to the Contractor. Important directions shall immediately be confirmed in writing to the Contractor. Other directions will be confirmed on written request. The Contractor shall give efficient superintendence to the work, using its best skill and attention.

Section 13 - Changes in the Work

The City may make changes to the quantities of work within the general scope of the Contract at any time by a written order and without notice to the sureties. If the changes add to or deduct from the extent of the work, the Contract Sum shall be adjusted accordingly. All the changes shall be executed under the conditions of the original Contract except that any claim for extension of time caused by the change shall be adjusted at the time of ordering the change.

In giving instructions, the Supervising Professional shall have authority to make minor changes in the work not involving extra cost and not inconsistent with the purposes of the work, but otherwise, except in an emergency endangering life or property, no extra work or change shall be made unless in pursuance of a written order by the Supervising Professional, and no claim for an addition to the Contract Sum shall be valid unless the additional work was ordered in writing.

The Contractor shall proceed with the work as changed and the value of the work shall be determined as provided in Claims for Extra Cost - Section 15.

Section 14 - Extension of Time

Extension of time stipulated in the Contract for completion of the work will be made if and as the Supervising Professional may deem proper under any of the following circumstances:

- (1) When work under an extra work order is added to the work under this Contract;
- (2) When the work is suspended as provided in Section 20;
- (3) When the work of the Contractor is delayed on account of conditions which could not have been foreseen, or which were beyond the control of the Contractor, and which were not the result of its fault or negligence;
- (4) Delays in the progress of the work caused by any act or neglect of the City or of its employees or by other Contractors employed by the City;
- (5) Delay due to an act of Government;
- (6) Delay by the Supervising Professional in the furnishing of plans and necessary information;
- (7) Other cause which in the opinion of the Supervising Professional entitles the Contractor to an extension of time.

The Contractor shall notify the Supervising Professional within 7 days of an occurrence or conditions which, in the Contractor's opinion, entitle it to an extension of time. The notice shall be in writing and submitted in ample time to permit full investigation and evaluation of the Contractor's claim. The Supervising Professional shall acknowledge receipt of the Contractor's notice within 7 days of its receipt. Failure to timely provide the written notice shall constitute a waiver by the Contractor of any claim.

In situations where an extension of time in contract completion is appropriate under this or any other section of the contract, the Contractor understands and agrees that the only available adjustment for events that cause any delays in contract completion shall be extension of the required time for contract completion and that there shall be no adjustments in the money due the Contractor on account of the delay.

Section 15 - Claims for Extra Cost

If the Contractor claims that any instructions by drawings or other media issued after the date of the Contract involved extra cost under this Contract, it shall give the Supervising Professional written notice within 7 days after the receipt of the instructions, and in any event before proceeding to execute the work, except in emergency endangering life or property. The procedure shall then be as provided for Changes in the Work-Section 13. No claim shall be valid unless so made.

If the Supervising Professional orders, in writing, the performance of any work not covered by the contract documents, and for which no item of work is provided in the Contract, and for which no unit price or lump sum basis can be agreed upon, then the extra work shall be done on a Cost-Plus-Percentage basis of payment as follows:

- (1) The Contractor shall be reimbursed for all reasonable costs incurred in doing the work, and shall receive an additional payment of 15% of all the reasonable costs to cover both its indirect overhead costs and profit;
- (2) The term "Cost" shall cover all payroll charges for employees and supervision required under the specific order, together with all worker's compensation, Social Security, pension and retirement allowances and social insurance, or other regular payroll charges on same; the cost of all material and supplies required of either temporary or permanent character; rental of all power-driven equipment at agreed upon rates, together with cost of fuel and

supply charges for the equipment; and any costs incurred by the Contractor as a direct result of executing the order, if approved by the Supervising Professional;

- (3) If the extra is performed under subcontract, the subcontractor shall be allowed to compute its charges as described above. The Contractor shall be permitted to add an additional charge of 5% percent to that of the subcontractor for the Contractor's supervision and contractual responsibility;
- (4) The quantities and items of work done each day shall be submitted to the Supervising Professional in a satisfactory form on the succeeding day, and shall be approved by the Supervising Professional and the Contractor or adjusted at once;
- (5) Payments of all charges for work under this Section in any one month shall be made along with normal progress payments. Retainage shall be in accordance with Progress Payments-Section 16.

No additional compensation will be provided for additional equipment, materials, personnel, overtime or special charges required to perform the work within the time requirements of the Contract.

When extra work is required and no suitable price for machinery and equipment can be determined in accordance with this Section, the hourly rate paid shall be 1/40 of the basic weekly rate listed in the Rental Rate Blue Book published by Dataquest Incorporated and applicable to the time period the equipment was first used for the extra work. The hourly rate will be deemed to include all costs of operation such as bucket or blade, fuel, maintenance, "regional factors", insurance, taxes, and the like, but not the costs of the operator.

Section 16 - Progress Payments

The Contractor shall submit each month, or at longer intervals, if it so desires, an invoice covering work performed for which it believes payment, under the Contract terms, is due. The submission shall be to the City's Finance Department - Accounting Division. The Supervising Professional will, within 10 days following submission of the invoice, prepare a certificate for payment for the work in an amount to be determined by the Supervising Professional as fairly representing the acceptable work performed during the period covered by the Contractor's invoice. To insure the proper performance of this Contract, the City will retain a percentage of the estimate in accordance with Act 524, Public Acts of 1980. The City will then, following the receipt of the Supervising Professional's Certificate, make payment to the Contractor as soon as feasible, which is anticipated will be within 15 days.

An allowance may be made in progress payments if substantial quantities of permanent material have been delivered to the site but not incorporated in the completed work if the Contractor, in the opinion of the Supervising Professional, is diligently pursuing the work under this Contract. Such materials shall be properly stored and adequately protected. Allowance in the estimate shall be at the invoice price value of the items. Notwithstanding any payment of any allowance, all risk of loss due to vandalism or any damages to the stored materials remains with the Contractor.

In the case of Contracts which include only the Furnishing and Delivering of Equipment, the payments shall be; 60% of the Contract Sum upon the delivery of all equipment to be furnished, or in the case of delivery of a usable portion of the equipment in advance of the total equipment delivery, 60% of the estimated value of the portion of the equipment may be paid upon its delivery in advance of the time of the remainder of the equipment to be furnished; 30% of the Contract Sum upon completion of erection of all equipment furnished, but not later than 60 days after the date of delivery of all of the equipment to be furnished; and payment of the final 10% on final completion of erection, testing and acceptance of all the equipment to be furnished; but not later than 180 days after the date of delivery of all of the equipment to be furnished, unless testing has

been completed and shows the equipment to be unacceptable.

With each invoice for periodic payment, the Contractor shall enclose a Contractor's Declaration - Section 43, and an updated project schedule per Order of Completion - Section 2.

Section 17 - Deductions for Uncorrected Work

If the Supervising Professional decides it is inexpedient to correct work that has been damaged or that was not done in accordance with the Contract, an equitable deduction from the Contract price shall be made.

Section 18 - Correction of Work Before Final Payment

The Contractor shall promptly remove from the premises all materials condemned by the Supervising Professional as failing to meet Contract requirements, whether incorporated in the work or not, and the Contractor shall promptly replace and re-execute the work in accordance with the Contract and without expense to the City and shall bear the expense of making good all work of other contractors destroyed or damaged by the removal or replacement.

If the Contractor does not remove the condemned work and materials within 10 days after written notice, the City may remove them and, if the removed material has value, may store the material at the expense of the Contractor. If the Contractor does not pay the expense of the removal within 10 days thereafter, the City may, upon 10 days written notice, sell the removed materials at auction or private sale and shall pay to the Contractor the net proceeds, after deducting all costs and expenses that should have been borne by the Contractor. If the removed material has no value, the Contractor must pay the City the expenses for disposal within 10 days of invoice for the disposal costs.

The inspection or lack of inspection of any material or work pertaining to this Contract shall not relieve the Contractor of its obligation to fulfill this Contract and defective work shall be made good. Unsuitable materials may be rejected by the Supervising Professional notwithstanding that the work and materials have been previously overlooked by the Supervising Professional and accepted or estimated for payment or paid for. If the work or any part shall be found defective at any time before the final acceptance of the whole work, the Contractor shall forthwith make good the defect in a manner satisfactory to the Supervising Professional. The judgment and the decision of the Supervising Professional as to whether the materials supplied and the work done under this Contract comply with the requirements of the Contract shall be conclusive and final.

Section 19 - Acceptance and Final Payment

Upon receipt of written notice that the work is ready for final inspection and acceptance, the Supervising Professional will promptly make the inspection. When the Supervising Professional finds the work acceptable under the Contract and the Contract fully performed, the Supervising Professional will promptly sign and issue a final certificate stating that the work required by this Contract has been completed and is accepted by the City under the terms and conditions of the Contract. The entire balance found to be due the Contractor, including the retained percentage, shall be paid to the Contractor by the City within 30 days after the date of the final certificate.

Before issuance of final certificates, the Contractor shall file with the City:

- (1) The consent of the surety to payment of the final estimate;
- (2) The Contractor's Affidavit in the form required by Section 44.

In case the Affidavit or consent is not furnished, the City may retain out of any amount due the Contractor, sums sufficient to cover all lienable claims.

The making and acceptance of the final payment shall constitute a waiver of all claims by the City except those arising from:

- (1) unsettled liens;
- (2) faulty work appearing within 12 months after final payment;
- (3) hidden defects in meeting the requirements of the plans and specifications;
- (4) manufacturer's guarantees.

It shall also constitute a waiver of all claims by the Contractor, except those previously made and still unsettled.

Section 20 - Suspension of Work

The City may at any time suspend the work, or any part by giving 5 days notice to the Contractor in writing. The work shall be resumed by the Contractor within 10 days after the date fixed in the written notice from the City to the Contractor to do so. The City shall reimburse the Contractor for expense incurred by the Contractor in connection with the work under this Contract as a result of the suspension.

If the work, or any part, shall be stopped by the notice in writing, and if the City does not give notice in writing to the Contractor to resume work at a date within 90 days of the date fixed in the written notice to suspend, then the Contractor may abandon that portion of the work suspended and will be entitled to the estimates and payments for all work done on the portions abandoned, if any, plus 10% of the value of the work abandoned, to compensate for loss of overhead, plant expense, and anticipated profit.

Section 21 - Delays and the City's Right to Terminate Contract

If the Contractor refuses or fails to prosecute the work, or any separate part of it, with the diligence required to insure completion, ready for operation, within the allowable number of consecutive calendar days specified plus extensions, or fails to complete the work within the required time, the City may, by written notice to the Contractor, terminate its right to proceed with the work or any part of the work as to which there has been delay. After providing the notice the City may take over the work and prosecute it to completion, by contract or otherwise, and the Contractor and its sureties shall be liable to the City for any excess cost to the City. If the Contractor's right to proceed is terminated, the City may take possession of and utilize in completing the work, any materials, appliances and plant as may be on the site of the work and useful for completing the work. The right of the Contractor to proceed shall not be terminated or the Contractor charged with liquidated damages where an extension of time is granted under Extension of Time - Section 14.

If the Contractor is adjudged a bankrupt, or if it makes a general assignment for the benefit of creditors, or if a receiver is appointed on account of its insolvency, or if it persistently or repeatedly refuses or fails except in cases for which extension of time is provided, to supply enough properly skilled workers or proper materials, or if it fails to make prompt payments to subcontractors or for material or labor, or persistently disregards laws, ordinances or the instructions of the Supervising Professional, or otherwise is guilty of a substantial violation of any provision of the Contract, then the City, upon the certificate of the Supervising Professional that sufficient cause exists to justify such action, may, without prejudice to any other right or remedy and after giving the Contractor 3 days written notice, terminate this Contract. The City may then take possession of the premises and of all materials, tools and appliances thereon and without prejudice to any other remedy it may have, make good the deficiencies or finish the work by whatever method it may deem expedient, and deduct the cost from the payment due the Contractor. The Contractor shall not be entitled to receive any further payment until the work is finished. If the expense of finishing the work, including compensation for additional managerial and administrative services exceeds the unpaid balance of the Contract Sum, the Contractor and its surety are liable to the City for any

excess cost incurred. The expense incurred by the City, and the damage incurred through the Contractor's default, shall be certified by the Supervising Professional.

Section 22 - Contractor's Right to Terminate Contract

If the work should be stopped under an order of any court, or other public authority, for a period of 3 months, through no act or fault of the Contractor or of anyone employed by it, then the Contractor may, upon 7 days written notice to the City, terminate this Contract and recover from the City payment for all acceptable work executed plus reasonable profit.

Section 23 - City's Right To Do Work

If the Contractor should neglect to prosecute the work properly or fail to perform any provision of this Contract, the City, 3 days after giving written notice to the Contractor and its surety may, without prejudice to any other remedy the City may have, make good the deficiencies and may deduct the cost from the payment due to the Contractor.

Section 24 - Removal of Equipment and Supplies

In case of termination of this Contract before completion, from any or no cause, the Contractor, if notified to do so by the City, shall promptly remove any part or all of its equipment and supplies from the property of the City, failing which the City shall have the right to remove the equipment and supplies at the expense of the Contractor.

The removed equipment and supplies may be stored by the City and, if all costs of removal and storage are not paid by the Contractor within 10 days of invoicing, the City upon 10 days written notice may sell the equipment and supplies at auction or private sale, and shall pay the Contractor the net proceeds after deducting all costs and expenses that should have been borne by the Contractor and after deducting all amounts claimed due by any lien holder of the equipment or supplies.

Section 25 - Responsibility for Work and Warranties

The Contractor assumes full responsibility for any and all materials and equipment used in the construction of the work and may not make claims against the City for damages to materials and equipment from any cause except negligence or willful act of the City. Until its final acceptance, the Contractor shall be responsible for damage to or destruction of the project (except for any part covered by Partial Completion and Acceptance - Section 26). The Contractor shall make good all work damaged or destroyed before acceptance. All risk of loss remains with the Contractor until final acceptance of the work (Section 19) or partial acceptance (Section 26). The Contractor is advised to investigate obtaining its own builders risk insurance.

The Contractor shall guarantee the quality of the work for a period of one year. The Contractor shall also unconditionally guarantee the quality of all equipment and materials that are furnished and installed under the contract for a period of one year. At the end of one year after the Contractor's receipt of final payment, the complete work, including equipment and materials furnished and installed under the contract, shall be inspected by the Contractor and the Supervising Professional. Any defects shall be corrected by the Contractor at its expense as soon as practicable but in all cases within 60 days. Any defects that are identified prior to the end of one year shall also be inspected by the Contractor and the Supervising Professional and shall be corrected by the Contractor at its expense as soon as practicable but in all cases within 60 days. The Contractor shall assign all manufacturer or material supplier warranties to the City prior to final payment. The assignment shall not relieve the Contractor of its obligations under this paragraph to correct defects.

Section 26 - Partial Completion and Acceptance

If at any time prior to the issuance of the final certificate referred to in Acceptance and Final Payment - Section 19, any portion of the permanent construction has been satisfactorily completed, and if the Supervising Professional determines that portion of the permanent construction is not required for the operations of the Contractor but is needed by the City, the Supervising Professional shall issue to the Contractor a certificate of partial completion, and immediately the City may take over and use the portion of the permanent construction described in the certificate, and exclude the Contractor from that portion.

The issuance of a certificate of partial completion shall not constitute an extension of the Contractor's time to complete the portion of the permanent construction to which it relates if the Contractor has failed to complete it in accordance with the terms of this Contract. The issuance of the certificate shall not release the Contractor or its sureties from any obligations under this Contract including bonds.

If prior use increases the cost of, or delays the work, the Contractor shall be entitled to extra compensation, or extension of time, or both, as the Supervising Professional may determine.

Section 27 - Payments Withheld Prior to Final Acceptance of Work

The City may withhold or, on account of subsequently discovered evidence, nullify the whole or part of any certificate to the extent reasonably appropriate to protect the City from loss on account of:

- (1) Defective work not remedied;
- (2) Claims filed or reasonable evidence indicating probable filing of claims by other parties against the Contractor;
- (3) Failure of the Contractor to make payments properly to subcontractors or for material or labor;
- (4) Damage to another Contractor.

When the above grounds are removed or the Contractor provides a Surety Bond satisfactory to the City which will protect the City in the amount withheld, payment shall be made for amounts withheld under this section.

Section 28 - Contractor's Insurance

- (1) The Contractor shall procure and maintain during the life of this Contract, including the guarantee period and during any warranty work, such insurance policies, including those set forth below, as will protect itself and the City from all claims for bodily injuries, death or property damage which may arise under this Contract; whether the act(s) or omission(s) giving rise to the claim were made by the Contractor or by any subcontractor or anyone employed by them directly or indirectly. In the case of all contracts involving on-site work, the Contractor shall provide to the City, before the commencement of any work under this contract, certificates of insurance and other documentation satisfactory to the City demonstrating it has obtained the policies and endorsements required on behalf of itself, and when requested, any subcontractor(s). The certificates of insurance endorsements and/or copies of policy language shall document that the Contractor satisfies the following minimum requirements.

- (a) Worker's Compensation Insurance in accordance with all applicable state and federal statutes. Further, Employers Liability Coverage shall be obtained in the following minimum amounts:

Bodily Injury by Accident - \$500,000 each accident
Bodily Injury by Disease - \$500,000 each employee
Bodily Injury by Disease - \$500,000 each policy limit

- (b) Commercial General Liability Insurance equivalent to, as a minimum, Insurance Services Office form CG 00 01 07 98 or current equivalent. The City of Ann Arbor shall be named as an additional insured. There shall be no added exclusions or limiting endorsements specifically for the following coverages: Products and Completed Operations, Explosion, Collapse and Underground coverage or Pollution. Further there shall be no added exclusions or limiting endorsements which diminish the City's protections as an additional insured under the policy. The following minimum limits of liability are required:

\$1,000,000	Each occurrence as respect Bodily Injury Liability or Property Damage Liability, or both combined.
\$2,000,000	Per Job General Aggregate
\$1,000,000	Personal and Advertising Injury
\$2,000,000	Products and Completed Operations Aggregate

- (c) Motor Vehicle Liability Insurance, including Michigan No-Fault Coverages, equivalent to, as a minimum, Insurance Services Office form CA 00 01 07 97 or current equivalent. Coverage shall include all owned vehicles, all non-owned vehicles and all hired vehicles. The City of Ann Arbor shall be named as an additional insured. There shall be no added exclusions or limiting endorsements which diminish the City's protections as an additional insured under the policy. Further, the limits of liability shall be \$1,000,000 for each occurrence as respects Bodily Injury Liability or Property Damage Liability, or both combined.

- (d) Umbrella/Excess Liability Insurance shall be provided to apply excess of the Commercial General Liability, Employers Liability and the Motor Vehicle coverage enumerated above, for each occurrence and for aggregate in the amount of \$1,000,000.

- (2) Insurance required under subsection (1)(b) and (1)(c) above shall be considered primary as respects any other valid or collectible insurance that the City may possess, including any self-insured retentions the City may have; and any other insurance the City does possess shall be considered excess insurance only and shall not be required to contribute with this insurance. Further, the Contractor agrees to waive any right of recovery by its insurer against the City.
- (3) Insurance companies and policy forms are subject to approval of the City Attorney, which approval shall not be unreasonably withheld. Documentation must provide and demonstrate an unconditional 30 day written notice of cancellation in favor of the City of Ann Arbor. Further, the documentation must explicitly state the following: (a) the policy number; name of insurance company; name and address of the agent or authorized representative; name and address of insured; project name; policy expiration date; and specific coverage amounts; (b) any deductibles or self-insured retentions which shall be approved by the City, in its sole discretion; (c) that the policy conforms to the requirements specified Contractor shall furnish the City with satisfactory certificates of insurance and endorsements prior to commencement of any work. Upon request, the Contractor shall provide within 30 days a copy of the policy(ies) to the City. If any of the above coverages expire by their terms during the term of this Contract, the Contractor shall deliver proof of renewal and/or new policies and endorsements to the Administering Service Area/Unit at

least ten days prior to the expiration date.

- (4) Any Insurance provider of Contractor shall be admitted and authorized to do business in the State of Michigan and shall carry and maintain a minimum rating assigned by A.M. Best & Company's Key Rating Guide of "A-" Overall and a minimum Financial Size Category of "V". Insurance policies and certificates issued by non-admitted insurance companies are not acceptable unless approved in writing by the City.
- (5) City reserves the right to require additional coverage and/or coverage amounts as may be included from time to time in the Detailed Specifications for the Project.
- (6) The provisions of General Condition 28 shall survive the expiration or earlier termination of this contract for any reason.

Section 29 - Surety Bonds

Bonds will be required from the successful bidder as follows:

- (1) A Performance Bond to the City of Ann Arbor for the amount of the bid(s) accepted;
- (2) A Labor and Material Bond to the City of Ann Arbor for the amount of the bid(s) accepted.

Bonds shall be executed on forms supplied by the City in a manner and by a Surety Company authorized to transact business in Michigan and satisfactory to the City Attorney.

Section 30 - Damage Claims

The Contractor shall be held responsible for all damages to property of the City or others, caused by or resulting from the negligence of the Contractor, its employees, or agents during the progress of or connected with the prosecution of the work, whether within the limits of the work or elsewhere. The Contractor must restore all property injured including sidewalks, curbing, sodding, pipes, conduit, sewers or other public or private property to not less than its original condition with new work.

Section 31 - Refusal to Obey Instructions

If the Contractor refuses to obey the instructions of the Supervising Professional, the Supervising Professional shall withdraw inspection from the work, and no payments will be made for work performed thereafter nor may work be performed thereafter until the Supervising Professional shall have again authorized the work to proceed.

Section 32 - Assignment

Neither party to the Contract shall assign the Contract without the written consent of the other. The Contractor may assign any monies due to it to a third party acceptable to the City.

Section 33 - Rights of Various Interests

Whenever work being done by the City's forces or by other contractors is contiguous to work covered by this Contract, the respective rights of the various interests involved shall be established by the Supervising Professional, to secure the completion of the various portions of the work in general harmony.

The Contractor is responsible to coordinate all aspects of the work, including coordination of, and

with, utility companies and other contractors whose work impacts this project.

Section 34 - Subcontracts

The Contractor shall not award any work to any subcontractor without prior written approval of the City. The approval will not be given until the Contractor submits to the City a written statement concerning the proposed award to the subcontractor. The statement shall contain all information the City may require.

The Contractor shall be as fully responsible to the City for the acts and omissions of its subcontractors, and of persons either directly or indirectly employed by them, as it is for the acts and omissions of persons directly employed by it.

The Contractor shall cause appropriate provisions to be inserted in all subcontracts relative to the work to bind subcontractors to the Contractor by the terms of the General Conditions and all other contract documents applicable to the work of the subcontractors and to give the Contractor the same power to terminate any subcontract that the City may exercise over the Contractor under any provision of the contract documents.

Nothing contained in the contract documents shall create any contractual relation between any subcontractor and the City.

Section 35 - Supervising Professional's Status

The Supervising Professional has the right to inspect any or all work. The Supervising Professional has authority to stop the work whenever stoppage may be appropriate to insure the proper execution of the Contract. The Supervising Professional has the authority to reject all work and materials which do not conform to the Contract and to decide questions which arise in the execution of the work.

The Supervising Professional shall make all measurements and determinations of quantities. Those measurements and determinations are final and conclusive between the parties.

Section 36 - Supervising Professional's Decisions

The Supervising Professional shall, within a reasonable time after their presentation to the Supervising Professional, make decisions in writing on all claims of the City or the Contractor and on all other matters relating to the execution and progress of the work or the interpretation of the contract documents.

Section 37 - Storing Materials and Supplies

Materials and supplies may be stored at the site of the work at locations agreeable to the City unless specific exception is listed elsewhere in these documents. Ample way for foot traffic and drainage must be provided, and gutters must, at all times, be kept free from obstruction. Traffic on streets shall be interfered with as little as possible. The Contractor may not enter or occupy with agents, employees, tools, or material any private property without first obtaining written permission from its owner. A copy of the permission shall be furnished to the Supervising Professional.

Section 38 - Lands for Work

The Contractor shall provide, at its own expense and without liability to the City, any additional land and access that may be required for temporary construction facilities or for storage of materials.

Section 39 - Cleaning Up

The Contractor shall, as directed by the Supervising Professional, remove at its own expense from the City's property and from all public and private property all temporary structures, rubbish and waste materials resulting from its operations unless otherwise specifically approved, in writing, by the Supervising Professional.

Section 40 - Salvage

The Supervising Professional may designate for salvage any materials from existing structures or underground services. Materials so designated remain City property and shall be transported or stored at a location as the Supervising Professional may direct.

Section 41 - Night, Saturday or Sunday Work

No night or Sunday work (without prior written City approval) will be permitted except in the case of an emergency and then only to the extent absolutely necessary. The City may allow night work which, in the opinion of the Supervising Professional, can be satisfactorily performed at night. Night work is any work between 8:00 p.m. and 7:00 a.m. No Saturday work will be permitted unless the Contractor gives the Supervising Professional at least 48 hours but not more than 5 days notice of the Contractor's intention to work the upcoming Saturday.

Section 42 - Sales Taxes

Under State law the City is exempt from the assessment of State Sales Tax on its direct purchases. Contractors who acquire materials, equipment, supplies, etc. for incorporation in City projects are not likewise exempt. State Law shall prevail. The Bidder shall familiarize itself with the State Law and prepare its Bid accordingly. No extra payment will be allowed under this Contract for failure of the Contractor to make proper allowance in this bid for taxes it must pay.

Section 43

CONTRACTOR'S DECLARATION

I hereby declare that I have not, during the period _____, 20____, to _____, 20____, performed any work, furnished any materials, sustained any loss, damage or delay, or otherwise done anything in addition to the regular items (or executed change orders) set forth in the Contract titled _____, for which I shall ask, demand, sue for, or claim compensation or extension of time from the City, except as I hereby make claim for additional compensation or extension of time as set forth on the attached itemized statement. I further declare that I have paid all payroll obligations related to this Contract that have become due during the above period and that all invoices related to this Contract received more than 30 days prior to this declaration have been paid in full except as listed below.

There is/is not (Contractor please circle one and strike one as appropriate) an itemized statement attached regarding a request for additional compensation or extension of time.

Contractor

Date

By _____
(Signature)

Its _____
(Title of Office)

Past due invoices, if any, are listed below.

Section 44

CONTRACTOR'S AFFIDAVIT

The undersigned Contractor, _____, represents that on _____, 20____, it was awarded a contract by the City of Ann Arbor, Michigan to _____ under the terms and conditions of a Contract titled _____. The Contractor represents that all work has now been accomplished and the Contract is complete.

The Contractor warrants and certifies that all of its indebtedness arising by reason of the Contract has been fully paid or satisfactorily secured; and that all claims from subcontractors and others for labor and material used in accomplishing the project, as well as all other claims arising from the performance of the Contract, have been fully paid or satisfactorily settled. The Contractor agrees that, if any claim should hereafter arise, it shall assume responsibility for it immediately upon request to do so by the City of Ann Arbor.

The Contractor, for valuable consideration received, does further waive, release and relinquish any and all claims or right of lien which the Contractor now has or may acquire upon the subject premises for labor and material used in the project owned by the City of Ann Arbor.

This affidavit is freely and voluntarily given with full knowledge of the facts.

Contractor

Date

By _____
(Signature)

Its _____
(Title of Office)

Subscribed and sworn to before me, on this _____ day of _____, 20____
_____, _____ County, Michigan

Notary Public

_____ County, MI

My commission expires on:

STANDARD SPECIFICATIONS

All work under this contract shall be performed in accordance with the Michigan Department of Transportation (MDOT) 2012 Standard Specifications for Construction. All work under this Contract which is not included in these Standard Specifications, or which is performed using modifications to these Standard Specifications, shall be performed in accordance with the City of Ann Arbor Detailed Specifications, MDOT Supplemental Specifications, and MDOT Special Provisions included in these contract documents. Any reference to the Michigan Department of Transportation (the "Department") in the above Standard Specifications, Supplemental Specifications, and Special Provisions shall also mean the City of Ann Arbor.

The Michigan Department of Transportation 2012 Standard Specification for Construction may be downloaded from the following web link:

<http://mdotcf.state.mi.us/public/specbook/2012/>

CITY OF ANN ARBOR
DETAILED SPECIFICATION
FOR
GENERAL CONDITIONS

AA:DAD

1 of 2

03/15/16

a. Description. This item shall include all work described and required by the Plans and Specifications at each location for which no item of work is listed in the Bid Form, including but not limited to:

- Scheduling, coordination, and organization of all work, subcontractors, suppliers, testing, inspection, surveying, and staking.
- Coordination of, and cooperation with, other contractors, agencies, departments, and utilities.
- Protection and maintenance of utilities.
- Maintaining drainage.
- Maintaining driveways drive openings, sidewalks, bike paths, mail deliveries, and solid waste/recycle pick-ups. This includes the placement and maintenance of gravel in driveway openings as directed by the Engineer.
- Storing all materials and equipment off lawn areas.
- Temporary relocation and final replacement/re-setting of mailboxes.
- Coordination efforts to furnish various HMA mixtures as directed by the Engineer
- Coordination efforts to furnish and operate various-size vehicles/equipment as directed by the Engineer
- Furnishing and operating vacuum-type street cleaning equipment a minimum of once per week or more frequently as directed by the Engineer
- Furnishing and operating vacuum-type utility structure cleaning equipment
- Furnishing and operating both vibratory plate and pneumatic-type (“pogo-stick”) compactors
- Furnishing and operating a backhoe during all work activities
- Furnishing and operating a jackhammer and air compressor during all work activities
- Noise and dust control
- Mobilization(s) and demobilization(s).
- Furnishing submittals and certifications for materials and supplies
- All miscellaneous and incidental items such as overhead, insurance, and permits.
- Meeting all requirements relating to Debarment Certification, Davis Bacon Act, and Disadvantaged Business Enterprise, and providing the necessary documentation.

Data pertaining to existing soil borings and pavement sections, which are included in the Appendix of these Contract Documents, are provided to help the Engineer and Contractor determine the soil conditions existing within the construction area. The City in no way

guarantees existing conditions to be the same as shown in the data. The Contractor is solely responsible for any and all conclusions he/she may draw from the data.

Quantities as given are approximate and are estimated for bidding purposes. Quantities are not guaranteed and may vary by any amount. While it is the City's intent to complete the project substantially as drawn and specified herein, quantities may be changed or reduced to zero for cost savings or other reasons. **The City reserves the right to change the quantities, and no adjustment in unit price will be made for any change in any quantity.**

b. Materials. None Specified.

c. Construction. Not specified.

d. Measurement and Payment. The completed work, as described, will be measured and paid for at the contract unit price for the following pay item:

Pay Item

Pay Unit

General Conditions, Max \$____Lump Sum

This item of work will be paid for on a pro rata basis at the time of each progress payment. Measurement will be based on the ratio between work completed during the payment period and the total contract amount. When all of the work of this Contract has been completed, the measurement of this item shall be 1.0 Lump Sum, minus any deductions incurred for inadequate performance as described herein. This amount will not be increased for any reason, including extensions of time, extras, and/or additional work.

The unit price for this item of work shall include all labor, material, and equipment costs to perform all the work specified in the Standard Specifications and as modified by this Detailed Specification.

CITY OF ANN ARBOR
DETAILED SPECIFICATION
FOR
PROJECT SUPERVISION

AA:DAD

1 of 4

02/23/16

a. Description. The Contractor shall provide supervision in accordance with the City of Ann Arbor Standard Specifications, subsections 104.07 and 107.15 of the Michigan Department of Transportation (MDOT) 2012 Standard Specifications for Construction, and as described herein.

The Contractor shall designate a full-time Project Supervisor to act as the Contractor's agent/representative, and to be responsible for scheduling and coordination of all subcontractors, suppliers, other governmental agencies, and all public and private utility companies.

The Project Supervisor shall not be an active crew member of the Contractor, shall not be an active member or employee of any subcontractor's work force, and shall not perform general or specialized labor tasks. The Project Supervisor shall be a full-time employee of the General Contractor and shall have all needed authority to make binding decisions on behalf of the Contractor in all matters pertaining to performance and execution of the work of the project.

The Project Supervisor shall work exclusively on this project, and shall put forth his/her full effort into the organization and coordination of the work of this project.

One week prior to the pre-construction meeting, the Contractor shall designate a proposed Project Supervisor by name, and shall furnish the Engineer with a current, thorough, detailed summary of the proposed Project Supervisor's work history, outlining all previous supervisory experience on projects of a similar size and nature. The detailed work history shall include personal and professional references (names and phone numbers) of persons (previous owners or agents) who can attest to the qualifications and work history of the proposed Project Supervisor. Proposed candidates for Project Supervisor shall have a demonstrated ability to work harmoniously with the Engineer, the City, the public, subcontractors, and all other parties typically involved with work of this nature. The Engineer will have the authority to reject a proposed Project Supervisor whom he/she considers unqualified.

The Project Supervisor shall be available 24 hours-per-day to provide proper supervision, coordination and scheduling of the project for the duration of the Contract. The Contractor shall furnish the City with telephone numbers of the Project Supervisor in order to provide 24 hour-per-day access during business and non-business hours, including weekends and holidays.

The Project Supervisor shall be equipped by the Contractor with a "smart" mobile telephone with "data" and "text" capabilities to provide the City with 24 hour-per-day access to him/her during daily construction activities, during transit to and from the construction site, and during all non-business hours including weekends and holidays.

The Project Supervisor shall be equipped with assistants as necessary to provide project supervision as specified herein, and in accordance with the Contract.

CITY OF ANN ARBOR
DETAILED SPECIFICATION
FOR
PROJECT SUPERVISION

AA:DAD

2 of 4

02/23/16

1. Duties and Responsibilities. The Project Supervisor shall work harmoniously with the Engineer, the City, the public, subcontractors, and all other parties typically involved with work of this nature.

The Project Supervisor shall have a thorough, detailed understanding and working knowledge of all construction practices and methods specified elsewhere herein, as well as the handling, placement, testing and inspection of aggregates, aggregate products, bituminous concrete, Portland cement concrete materials, and other such materials and products related to the work of this project.

The Project Supervisor shall be responsible for all of the work of all of the Contractor's, subcontractors' and suppliers' work forces.

The Project Supervisor shall be responsible for proper and adequate maintenance (emissions, safety, and general operation) of all of the Contractor's, subcontractors' and suppliers' equipment and vehicles. The Project Supervisor shall make all needed diligent and good-faith efforts to ensure that all equipment utilized in the performance of the work is properly maintained, safe, and complies with all legal and environmental requirements of the work as set forth in section 107.15 of the MDOT 2012 Standard Specifications for Construction.

The Project Supervisor shall be responsible for the legal, proper and safe parking/storage of all of the Contractor's, subcontractors' and suppliers' equipment, work vehicles, and employee's vehicles.

The Project Supervisor shall schedule and coordinate the work of all parties involved in the project, including utility companies, testing agencies, governmental agencies, all City departments (such as Utilities and Transportation), and City inspectors.

The Project Supervisor shall coordinate and schedule the work of any independent survey crews that may be retained by the Engineer or City to witness and reset existing and new geographic/benchmark monuments. Failure to have existing monuments witnessed and reset may result in delays to the Contractor's work. Costs for such delays will be the Contractor's sole responsibility. The Project Supervisor shall also schedule and complete all needed survey request forms that are needed in order to schedule the services of survey personnel to properly layout all elements of the project work in accordance with the City of Ann Arbor Public Services Area Standard Specifications and the MDOT 2012 Standard Specifications for Construction.

The Project Supervisor shall coordinate and schedule inspection performed by the City and Consultants (including material testing firms) in a timely manner, to assure proper and timely testing and inspection of the work.

CITY OF ANN ARBOR
DETAILED SPECIFICATION
FOR
PROJECT SUPERVISION

AA:DAD

3 of 4

02/23/16

The Project Supervisor shall submit to the Engineer, an updated, detailed schedule of the proposed work on a weekly basis, and an update of all proposed changes on a daily basis.

The Project Supervisor and all subcontractors shall attend a weekly progress meeting chaired by the Engineer to discuss the work. Upon the completion of each meeting, the Engineer shall prepare and distribute, to all present, a written summary of the meeting's minutes. Those in attendance shall review the minutes and, if necessary, comment on any deficiencies or errors prior to or at the next scheduled progress meeting.

2. Additional Performance Requirements. If, in the sole opinion of the Engineer, the Project Supervisor is not adequately performing the duties as outlined in this Special Provision, the following system of notices will be given to the contractor with the associated penalties:

First Notice – A warning will be issued in writing to the Contractor detailing the deficiencies in the Project Supervision. The Contractor must respond within 7 calendar days in writing with a plan to correct the stated deficiencies. Failure to respond within 7 calendar days will result in the issuing of a second notice.

Second Notice – A second warning will be issued in writing to the contractor further detailing the deficiencies in the Project Supervision. A deduction of 10%, or \$10,000, whichever is greater, will be made from the original Project Supervision contract amount. The Contractor must respond within 7 calendar days in writing with a plan to correct the stated deficiencies. Failure to respond within 7 calendar days will result in the issuing of a third notice. At this time, the Engineer reserves the right to meet with personnel with the necessary authority within the Contractor's organization to discuss the deficiencies in the Project Supervision.

Third Notice – A third notice will be issued in writing to the Contractor further detailing the deficiencies in the Project Supervision. An additional deduction of 25%, or \$25,000, whichever is greater, will be made from the original Project Supervision contract amount, and the Project Supervisor shall be removed from the project, and replaced immediately with another individual to be approved by the Engineer.

Should, in the sole opinion of the Engineer, the Project Supervisor fail to perform his/her duties and responsibilities as described herein to such a degree that the successful completion of the project is put in jeopardy, the above system of notices may be foregone, and the Contractor shall immediately replace the Project Supervisor upon receipt of written notice. Failure to provide adequate project supervision, as determined by the Engineer, shall be considered basis for the Engineer to suspend work without extension of contract time or additional compensation.

If the original Project Supervision contract amount is insufficient to cover said deductions, the Project Supervision contract amount will be reduced to zero and a

CITY OF ANN ARBOR
DETAILED SPECIFICATION
FOR
PROJECT SUPERVISION

AA:DAD

4 of 4

02/23/16

contract modification will be written to assess a penalty to cover the difference between the Project Supervision contract amount and the total amount of the deduction(s). It is fully expected however that the Project Supervision contract amount will be sufficient to cover any deductions.

b. Materials. None Specified.

c. Construction. Not specified.

d. Measurement and Payment. The completed work, as described, will be measured and paid for at the contract unit price for the following pay item:

<u>Pay Item</u>	<u>Pay Unit</u>
Project Supervision, Max \$100,000	Lump Sum

The unit price for this item of work shall include all labor, material, and equipment costs to perform all the work specified in the Standard Specifications, and as modified by this Detailed Specification.

Payment for this work will be made with each progress payment, on a pro rata basis, based on the percentage of construction completed. When all of the work of this Contract has been completed, the measurement of this item shall be 1.0 times the Lump Sum bid amount, minus any deductions incurred for inadequate performance as described herein. This amount will not be increased for any reason, including extensions of time, extras, adjustments and/or additional work.

CITY OF ANN ARBOR
DETAILED SPECIFICATION
FOR
CERTIFIED PAYROLL COMPLIANCE AND REPORTING

AA:MGN

1 of 2

02/16/17

a. Description. This specification covers all administrative requirements, payroll reporting procedures to be followed by Contractors performing work on City-sponsored public improvements projects, and all other miscellaneous and incidental costs associated with complying with the applicable sections of the City of Ann Arbor Code of Ordinances with regard to payment of prevailing wages and its Prevailing Wage Compliance policy.

This specification is **not** intended to include the actual labor costs associated with the payment of prevailing wages as required. Those costs should be properly incorporated in all other items of work bid.

b. General. The Contractor is expected to comply with all applicable sections of Federal and State prevailing wage laws, duly promulgated regulations, the City of Ann Arbor Code of Ordinances, and its Prevailing Wage Compliance Policy as defined within the contract documents. The Contractor shall provide the required certified payrolls, city-required declarations, and reports requested elsewhere in the contract documents within the timeline(s) stipulated therein.

The Contractor shall also provide corrected copies of any submitted documents that are found to contain errors, omissions, inconsistencies, or other defects that render the report invalid. The corrected copies shall be provided when requested by the Supervising Professional.

The Contractor shall also attend any required meetings as needed to fully discuss and ensure compliance with the contract requirements regarding prevailing wage compliance. The Contractor shall require all employees engaged in on-site work to participate in, provide the requested information to the extent practicable, and cooperate in the interview process. The City of Ann Arbor will provide the needed language interpreters in order to perform wage rate interviews or other field investigations as needed.

Certified Payrolls may be submitted on City-provided forms or forms used by the Contractor, as long as the Contractor's forms contain all required payroll information. If the Contractor elects to provide their own forms, the forms shall be approved by the Supervising Professional prior to the beginning of on-site work.

c. Unbalanced Bidding. The City of Ann Arbor will examine the submitted cost for this item of work prior to contract award. If the City determines, in its sole discretion, that the costs bid by the Contractor for complying with the contract requirements are not

reasonable, accurately reported, or may contain discrepancies, the City reserves the right to request additional documentation that fully supports and justifies the price as bid. Should the submitted information not be determined to be reasonable or justify the costs, the City reserves the right to pursue award of the contract to the second low bidder without penalty or prejudice to any other remedies that it may have or may elect to exercise with respect to the original low-bidder.

The Contract Completion date will not be extended as a result of the City's investigation of the as-bid amount for this item of work, even if the anticipated contract award date must be adjusted. The only exception will be if the Contractor adequately demonstrates that their costs were appropriate and justifiable. If so, the City will adjust the contract completion date by the number of calendar days commensurate with the length of the investigation, if the published Notice to Proceed date of the work cannot be met. The contract unit prices for all other items of work will not be adjusted regardless of an adjustment of the contract completion date being made.

d. Measurement and Payment. The completed work as measured for this item of work will be paid for at the Contract Unit Price for the following Contract (Pay) Item:

<u>Contract Item (Pay Item)</u>	<u>Pay Unit</u>
Certified Payroll Compliance and Reporting	Lump Sum

The unit price for this item of work shall include all supervisory, accounting, administrative, and equipment costs needed to monitor and perform all work related to maintaining compliance with the tasks specified in this Detailed Specification, the City of Ann Arbor Code of Ordinances, its Prevailing Wage Compliance policy and the applicable Federal and State laws.

Payment for this work will be made with each progress payment, on a pro-rata basis, based on the percentage of construction completed. When all of the work of this contract has been completed, the measurement of this item shall be 1.0 times the Lump Sum bid amount. This amount will not be increased for any reason, including extensions of time, extra work, and/or adjustments to existing items of work.

CITY OF ANN ARBOR
DETAILED SPECIFICATION
FOR
VACUUM TYPE CLEANING EQUIPMENT

AA:DAD

1 of 1

04/08/15

a. Description. This work includes furnishing and operating throughout the construction period, vacuum type street cleaning and utility structure cleaning equipment (Vac-All, Vactor, etc.) approved by the Engineer, as and when directed by the Engineer for dust control, for dirt/debris control, and for street cleaning immediately prior to paving, and for street and utility structure cleaning after any and all paving.

b. Materials. None specified.

c. Construction. The Contractor shall furnish and operate throughout the construction period, vacuum type street cleaning and utility structure cleaning equipment (Vac-All, Vactor, etc.) approved by the Engineer. When directed by the Engineer, the Contractor shall use this equipment to control dust, dirt, and other debris within the project limits and beyond as required, to clean streets surfaces immediately prior to placing HMA pavement mixtures, and for street and utility structure cleaning after any and all paving. The cleaning equipment shall be of sufficient power to remove dust, dirt, and debris from the pavement and from utility structures in and adjacent to the construction area.

d. Measurement and Payment. Costs for this work will not be paid for separately, but shall be included in the Contract pay Item "General Conditions, Maximum, \$___".

CITY OF ANN ARBOR
DETAILED SPECIFICATION
FOR
MATERIAL AND SUPPLIES CERTIFICATIONS

AA:DAD

1 of 1

04/08/15

a. Description. This work includes furnishing certifications to the Engineer for review and approval a minimum of three business days prior to any scheduled delivery, installation, and/or construction of same. The following materials and supplies shall be certified by the manufacturer or supplier as having been tested for compliance with the Specifications:

- HMA materials
- Hot-poured Joint Sealants
- Cements, coatings, admixtures and curing materials
- Sands and Aggregates
- Steel and Fabricated metal
- Portland Cement Concrete Mixtures
- Reinforcing Steel for Concrete
- Reinforcing Fibers for Concrete
- Pre-cast Concrete products
- Sanitary Sewer Pipe
- Storm Sewer Pipe
- Water Main Pipe
- Corrugated Metal Pipe
- High Density Polyethylene Pipe
- Timber for retaining walls
- Modular Concrete Block for retaining walls
- Edge Drain and Underdrain Pipe
- Geotextile Filter Fabric and Stabilization Fabric/Grids

b. Materials. None specified.

c. Construction. Not specified.

d. Measurement and Payment. Costs for this work will not be paid for separately, but shall be included in the Contract pay Item "General Conditions, Maximum, \$____".

CITY OF ANN ARBOR
DETAILED SPECIFICATION
FOR
PROJECT SCHEDULE

AA:DAD

1 of 2

03/05/17

Complete the entirety of work under this Contract in accordance with, and subject to, the scheduling requirements as outlined below, and all other requirements of the Contract Documents.

Organize, coordinate and diligently execute the work at the locations shown on the Schedule of Streets included herein. This schedule details the requirements, if any, for the Start of Work (on or after dates specified), the Completion of Work (on or before dates specified), Restricted Dates, the Maximum Calendar Days for Completion, and the Liquidated Damages per Calendar Day for each street. For the purpose of this Contract, the "Start of Work" definition is the date when either the "No-Parking" signs or the temporary traffic control measures become effective, whichever occurs first. The definition of the "Completion of Work" is the point in time when all work designated for a project location is complete. This includes, but is not limited to, placement of permanent pavement markings, driveway wedging, slope restoration, clean-up, street cleaning, underground utility and utility structure cleaning, the removal of all temporary traffic control devices and "No Parking" signs, and other necessary work and as directed by the Engineer.

The Engineer shall limit the Contractor's work operations to a number of streets that, in the opinion of the Engineer, is reasonable to allow for proper and thorough inspection, and to reduce traffic control and/or safety problems. The contractor shall not have more than four (4) locations "active" at any given time with a maximum of three (3) of those locations being Major Streets. A location is "active" if work on the street has begun, and it has not yet complete. Regard combined streets shown on the Schedule of Streets as one (1) location.

The City expects to furnish the Contractor with two (2) copies of the Contract, for its execution, on or before **April 4, 2017**. The Contractor shall properly execute both copies of the Contract and return them, with the required Bonds and Insurance documentation, to the City by **April 21, 2017**. The Contractor shall not begin the work before the applicable date(s) as described herein without approval from the Project Engineer, and in no case before the receipt of the fully executed Contract and Notice to Proceed.

By no later than **April 28, 2017**, the Contractor shall submit a detailed schedule of work (progress schedule) for the Engineer's review and approval. The progress schedule must fully comply with the scheduling requirements contained on the Schedule of Streets. The schedule shall clearly indicate, in detail, the start and the finish date of each work task on each street. The Contractor shall update the approved progress schedule each week, and present it to the Engineer at the weekly progress meeting, and must consult with the Engineer for review and approval of any proposed deviations from the most current, approved, schedule.

The Contractor shall begin the work of this project on or before **May 8, 2017**, and only upon receipt of the fully executed Contract, Notice to Proceed and approved Progress Schedule. The City will consider granting appropriate time extensions should delays prevent the Contractor from starting work on this date.

Complete the entire project on or before **October 28, 2017**. Completion of the project means all locations shown on the Schedule of Streets are complete and ready for use in accordance with the "Completion of Work" as defined above.

Failure to complete all work as specified herein within the times specified herein, including time extensions granted thereto as determined by the Engineer, shall entitle the City to deduct from the payments due the Contractor, the dollar amounts specified in the Schedule of Streets as "Liquidated Damages" for delays in the completion of the work for each incomplete street, for each and every calendar day.

Time is of the essence in the performance of the work of this contract. The Contractor is expected to mobilize sufficient personnel and equipment and work throughout all authorized hours to complete the project by the intermediate (location specific) and final completion dates. Should the Contractor demonstrate that they must work on some Sundays in order to maintain the project schedule, they may do so between the hours of 9:00 a.m. and 5:00 p.m. with prior approval from the City. There will be no additional compensation due to the Contractor for work performed on Sundays.

The Engineer may delay or stop the work due to threatening weather conditions. No compensation shall be due the Contractor for unused materials or downtime due to rain, or the threat of rain. The Contractor is solely responsible for repairing all damages to the work and to the site, including road infrastructures, road subgrades, and any adjacent properties resulting from its decision to work in the rain.

The Contractor shall not work in the dark except as approved by the Engineer and shall provide lighting for night work as detailed elsewhere in this contract. The Engineer may stop the work, or may require the Contractor to defer certain work to another day, if, in the Engineer's opinion, the Contractor cannot be complete the work within the remaining daylight hours, or if inadequate daylight is present to properly perform or inspect the work. No compensation shall be due to the Contractor for unused materials or downtime, when the Engineer directs work stoppage for reasons due to darkness and/or inadequate remaining daylight. The Contractor is solely responsible for repairing all damages to the work and to the site, including road infrastructures, road subgrades, and any adjacent properties, which result from working in the dark.

Assessment of Liquidated Damages will occur until the required work is complete in the current construction season. If, with the Engineer's approval, work extends beyond seasonal limitations, the assessment of Liquidated Damages will discontinue until the work resumes in the following construction season.

If the construction contract is not complete within the specified period(s) including any extensions of time granted thereto, at the sole discretion of the City of Ann Arbor, this Contract may be terminated. Should this occur no additional compensation will be due to the Contractor, and the Contractor may be forbidden to bid on future City of Ann Arbor projects for a period of at least three (3) years. If the Engineer elects to terminate the Contract, payment for contract items with a Lump Sum unit price will be up to a maximum amount equal to the percentage of the contract work that is complete at the time of termination.

The City's decision to delete streets, add streets, change the construction limits on streets, or, the City's contribution to a delay of the construction on any one street shall not entitle the Contractor to receive additional compensation for work on any other street(s), nor shall it relieve the Contractor of any responsibilities for completion of work on any other street(s).

Costs for the Contractor to organize, coordinate, and schedule all of the project work will not be paid for separately, but shall be included in the bid price of the Contract Item "General Conditions, Max \$____"

Street Resurfacing – 2017

Schedule of Streets

Location (Street)	Limits of Work	Start of Work	Completion of Work	Restricted Dates	Maximum Calendar Days for Completion	Liquidated Damages per Calendar Day
MAJOR STREETS						
Arlington Boulevard	Washtenaw Ave to Geddes Ave		07/03/2017	MMRL	54	\$750.00
Catherine Street	N Main St to Glen Ave			AAAF, MMRL, INDP, LABR, UMFB, UMMSM	24	\$1,000.00
Church Street	S University Ave to Geddes Ave			DDA, LABR, UMFB, UMMSM	21	\$1,000.00
South University Avenue	E University Ave to Washtenaw Ave					
Green Road Non-motorized Path	Nixon Rd to Burbank Dr / Gettysburg Rd			MMRL, INDP, LABR	21	\$500.00
Hill Street	Onondaga St to Geddes Ave	07/05/2017		LABR	28	\$750.00
Miller Avenue	City Limits to N Maple Rd			CAA2	21	\$750.00
South Division Street	E Jefferson Ave to E Huron St		07/15/2017	MMRL, INDP	63	\$1,000.00
West Liberty Road	Scio Ridge Rd to S Maple Rd			WCRC, LABR	24	\$750.00
West Stadium Boulevard	S Main St to Hutchins Ave			CAA1, LABR, UMFB	14	\$1000.00
MINOR (LOCAL) STREETS						
4th Street	W Madison St to W William St					
5th Street	Princeton St to W Liberty St			AAAF, AAAF	75	\$750.00
West Jefferson Street	S 7th St to S Main St					
5th Street	W Hoover Ave to W Davis Ave					
West Davis Avenue	S 7th to 3rd St			AAAF, MMRL, INDP, LABR	60	\$500.00
Wilder Place	W Hoover Ave to W Davis Ave					
3rd Street	W Madison St to W William St					
6th Street	W Madison St to W Jefferson St	08/21/2017		LABR	35	\$500.00

Street Resurfacing – 2017

Schedule of Streets

Location (Street)	Limits of Work	Start of Work	Completion of Work	Restricted Dates	Maximum Calendar Days for Completion	Liquidated Damages per Calendar Day
MINOR (LOCAL) STREETS - CONTINUED						
High Orchard Drive	Geddes Rd to City Limit			MMRL, INDP, LABR	18	\$500.00
High Orchard Court	End (cul-de-sac) to High Orchard Dr					
Alley (south of West Madison St)	S Seventh St to End	07/01/2017		INDP, LABR	14	\$500.00
Arella Boulevard	Martha Ave to Pauline Blvd	07/01/2017		INDP, LABR	30	\$500.00
Island Drive	Canal St to Wall St			MMRL, INDP, LABR	21	\$500.00

AAPS – No work permitted when Ann Arbor Public Schools are in session (before June 19, 2017 or after September 1, 2017).

AAAF – No work permitted from July 20, 2017 thru July 23, 2017 due to the Ann Arbor Street Art Fairs.

CAA1 – No work permitted until the City of Ann Arbor East Stadium Boulevard construction project is open to traffic (anticipated by August 15, 2017).

CAA2 – No work permitted until the City of Ann Arbor North Maple Road/Miller Avenue sidewalk construction project is complete (anticipated by September 30, 2017).

DDA – No work permitted until after the Ann Arbor Street Art Fairs or the completion of the Ann Arbor Downtown Development Authority South University Avenue Streetscape project, which occurs later (DDA project anticipated to be complete by August 19, 2017)

INDP – No work during the Independence Day holiday period from 3:00 p.m. July 3 to 7:00 a.m. July 5, 2017.

LABR – No work during the Labor Day holiday period from 3:00 p.m. September 1 to 7:00 a.m. September 5, 2017.

MMRL – No work during the Memorial Day holiday period from 3:00 p.m. May 26 to 7:00 a.m. May 30, 2017.

UMFB – No work permitted on University of Michigan home football game days.

UMSM – No work permitted during University of Michigan Student Move-in (September 1, 2017 thru September 4, 2017).

WCRC – No work permitted until the Scio Church Rd and Wagner Rd roundabout construction project is open to traffic (anticipated by July 28, 2017).

Notes:

1. Construct Church Street and South University Avenue concurrently.
2. Construct 4th Street, 5th Street (Princeton St to W Liberty St), and West Jefferson Street concurrently.
3. Construct 5th Street (W Hoover St to W Davis Ave), West Davis Avenue, and Wilder Pl concurrently.
4. Construct High Orchard Drive and High Orchard Court concurrently.
5. Construct 3rd Street and 6th Street concurrently.

CITY OF ANN ARBOR
DETAILED SPECIFICATION
FOR
LANDSCAPE BOULDER

AA:DAD

1 of 1

03/23/17

a. Description. Removal, salvage, and reinstallation in new locations all landscape boulders around the perimeter of the existing aggregate parking and driveway areas in Riverside Park as described herein, and as directed by the Engineer.

b. Materials. The bedding material shall meet the requirements of MDOT Class III Granular Material unless otherwise approved by the Engineer.

c. Construction. Remove and store on site all landscape boulders identified for relocation, and place them at their new locations as directed by the Engineer.

Prepare bedding material as required to create a level area for the permanent placement of the landscape boulder(s). The bedding material shall be placed and compacted in no greater than 6-inch lifts.

Place boulders individually using equipment capable of setting it in a final position at release and also capable of repositioning it after release, if necessary, in such a manner to avoid displacing, cracking, chipping, scratching or placing undue impact force on underlying materials. Re-handling of individual boulders shall be anticipated by the Contractor to achieve satisfactory final placement. Do not cast or drop boulders.

d. Measurement and Payment. The completed work, as described, will be measured and paid for at the contract unit price for the following pay item:

<u>Pay Item</u>	<u>Pay Unit</u>
Landscape Boulder, Rem and Salvage.....	Each

This item of work will be measured in place by unit each and paid for at the contract unit price for each, which price shall be payment in full for all labor, materials, and equipment needed to accomplish this work. It shall include, but not be limited to; all required excavation necessary to remove or install the boulder; removing, transporting, and storing the boulder in an area safe from other construction activities; furnishing, placing, compacting all bedding material; placing the boulders; and the clean-up and removal off-site of all excess excavated materials at the completion of the landscape boulder relocation.

CITY OF ANN ARBOR
DETAILED SPECIFICATION
FOR
PARKING BLOCKS

AA:DAD

1 of 1

03/23/17

a. Description. This work consists of excavating, as required, removing existing concrete parking blocks and disposing of removed materials, and backfilling the resulting excavated sites in accordance with section 204 of the Michigan Department of Transportation (MDOT) 2012 Standard Specifications for Construction, as specified herein, and as directed by the Engineer.

b. Materials. Provide materials in accordance with subsection 204.02 of the MDOT 2012 Standard Specifications for Construction, unless otherwise directed by the Engineer.

c. Construction. Breakdown and remove existing concrete parking blocks in accordance with subsection 204.03.A of the MDOT 2012 Standard Specifications for Construction, and as directed by the Engineer.

Dispose all materials in accordance with subsection 204.03.B of the MDOT 2012 Standard Specifications for Construction, and as directed by the Engineer.

Backfill excavated sites in accordance with subsection 204.03.C of the MDOT 2012 Standard Specifications for Construction, and as directed by the Engineer.

d. Measurement and Payment. The completed work, as described, will be measured and paid for at the contract unit prices for the following pay items:

<u>Pay Item</u>	<u>Pay Unit</u>
Parking Blocks, Rem.....	Each

Parking Blocks, Rem will be measured in place by the unit each and paid for at the contract unit price for each, which price shall be payment in full for all labor, materials, and equipment needed to accomplish this work.

The cost of breaking down and removing, sawing, disposing of materials, and providing, placing, and compacting backfill is included in the unit price for **Parking Blocks, Rem**.

CITY OF ANN ARBOR
DETAILED SPECIFICATION
FOR
REMOVING CONCRETE ITEMS

AA:DAD

1 of 2

02/23/16

a. Description. This work shall consist of removing concrete curb, gutter, curb and gutter, integral curb, sidewalk, sidewalk ramps, drive openings, and drive approach pavements as shown on the plans, in accordance with section 204 of the Michigan Department of Transportation (MDOT) 2012 Standard Specifications for Construction, except as specified herein, and as directed by the Engineer.

b. Materials. Materials shall be in accordance with those specified in section 204 of the MDOT Standard Specifications for Construction.

c. Construction. Construction methods shall be as described in section 204 of the MDOT 2012 Standard Specifications for Construction, as described below, and as directed by the Engineer.

Curb, gutter, curb and gutter, sidewalk, sidewalk ramps, drive openings, and drives shall be replaced within 24 hours of their removal.

Prior to the start of work, the Engineer and Contractor together shall identify and field measure all items to be removed. The Engineer shall approve of all removal limits prior to any removals being performed by the Contractor.

The Contractor shall perform full-depth saw cutting at removal limits, including those necessary to construct 2-foot wide MDOT Type M drive openings, and including those necessary to provide for the partial removal of existing drive approaches as shown on the Plans, as directed by the Engineer, and as marked for removal. The Contractor shall cut steel reinforcement bars as directed by the Engineer at all areas of removal. All saw cutting shall be performed under wet conditions to prevent excessive airborne dust. All resulting slurry and debris shall be cleaned up to the satisfaction of the Engineer.

The Contractor shall excavate, cut, remove stumps, remove brush, grade, and trim as needed and as directed, and shall import, furnish, fill, place, grade, and compact granular material as needed to complete the following: construct new concrete items; to repair or replace existing concrete items; to relocate existing concrete items to their new specified/directed elevations/locations, including all necessary grading at elevation changes of curb and gutter, sidewalks and ramps; and at locations where existing concrete items are to be removed and turf is to be established in its place.

The Contractor shall coordinate with the City Forester prior to the removal of any tree roots.

At various times throughout the work, the Engineer may direct the Contractor to use smaller and/or lighter equipment, and to defer certain work tasks, in order to protect the grade and/or adjacent areas. The Contractor shall not be entitled to any additional compensation for the use of smaller equipment, lighter equipment, or work task deferral.

The Contractor shall shape, grade, and compact the existing roadbed materials to the cross-section(s) as indicated on the Plans, as detailed in the Specifications, and as directed by the Engineer.

The Contractor shall use blade graders, maintainers, vibratory rollers, and/or other equipment as necessary, and as directed by the Engineer. The use of each specific piece of equipment is subject to the approval of the Engineer.

Where existing concrete curb or curb and gutter is to be replaced on a street with a concrete (or brick) base, the Engineer may direct the Contractor to remove a 1-to-2-foot wide, full-depth section of pavement and pavement base from immediately in front of the curb and gutter. As part of this pavement/base removal, the Contractor shall perform additional (double) full-depth saw-cutting along the entire removal limits, and shall take sufficient care so as not to damage and/or disturb any adjacent pavement, pavement base, and/or any other site feature, all as directed by the Engineer. The removals shall be to a sufficient width and depth to allow for the placement and removal of the curb and gutter formwork. After the removal of the formwork, the Contractor shall replace the concrete base to its original thickness and elevation(s).

Excavated/removal areas shall be adequately protected with barricades and/or fencing at all times.

Removed or excavated materials which are not incorporated into the work shall become the property of the Contractor and shall be immediately removed and properly disposed of off-site. Removed or excavated materials may not be stockpiled overnight on, or adjacent to, the site.

Base, subbase, or subgrade materials removed without authorization by the Engineer shall be replaced and compacted by the Contractor at the Contractor's expense, with materials specified by the Engineer.

d. Measurement and Payment. The completed work, as described, will be measured and paid for at the respective contract unit prices for the following respective pay items:

<u>Pay Item</u>	<u>Pay Unit</u>
Curb, Gutter, and Curb and Gutter, Any Type, Rem	Square Yard
Sidewalk, Sidewalk Ramp, and Driveway Approach, Any Thickness, Rem	Square Yard

Basis of payment shall be as described in subsection 205.04 of the Standard Specifications for Construction.

All sawcutting required for removals shall be included in the appropriate item of work, and will not be paid for separately. Payment for saw cutting to create or modify Type M openings and to allow for the partial removal of existing drives shall be included in the price of the item of work, "Sidewalk, Sidewalk Ramp, and Driveway Approach, Any Thickness, Rem".

CITY OF ANN ARBOR
DETAILED SPECIFICATION
FOR
MACHINE GRADING

AA:DAD

1 of 6

03/15/16

a. Description. Machine grading shall be completed in accordance with section 205 of the Michigan Department of Transportation (MDOT) 2012 Standard Specifications for Construction as shown on the plans, and as specified herein, with the exception that subgrade undercutting shall be paid for separately for applicable work when this pay item is included in the proposal. Machine grading shall include all the work specified herein for which there is no separate pay item. This work shall consist of constructing earth grades by excavating, cutting, filling, trimming, and grading; general restoration, and sign removals in accordance with the Detailed Specifications elsewhere herein; and maintaining the work in a finished condition until such time that it is accepted by the Engineer.

b. Materials. All materials shall meet the requirements as specified in section 205 of the MDOT 2012 Standard Specifications for Construction, except as specified herein.

c. Construction. All construction methods shall meet the requirements as specified in section 205 of the MDOT 2012 Standard Specifications for Construction, except as specified herein.

1. Soils Information - Soil information provided as part of the contract documents is for informational purposes only and shall not relieve the Contractor of the responsibility of investigating all local conditions before bidding.
2. General Provisions - The Contractor shall:
 - A. Grade around mailboxes, trees, light poles, power poles, and the like, which are to remain in place. The Contractor shall be responsible for any damage caused to such structures.
 - B. Maintain the work in a finished condition until it is accepted by the Engineer.
3. Pavement Sawcutting - The work shall include the full-depth saw-cutting of pavement at the construction limits, and elsewhere as required, if not paid for as part of another item of work. Pavement sawcutting will not be paid for separately.
4. Removal of Trees and Vegetation - The Contractor shall remove and properly dispose of off-site all vegetation; brush; roots; and trees and stumps less than 6 inch in diameter, as shown on the plans, and as directed by the Engineer as required to complete the project.
5. Removal and Salvaging of Topsoil - The removal, salvaging and stockpiling of topsoil, and all related work, shall be performed in accordance with subsection 205.03.A.1 (Removing and Salvaging Topsoil) of the MDOT 2012 Standard Specifications for Construction and will not be paid for separately.
6. Miscellaneous Removals - The removal of HMA, aggregate, and/or concrete materials from around manholes, structures, and utility covers, and the removal of HMA curbing, HMA driveway wedges, HMA surface on existing curb and gutter, and HMA surfaces required for removal in other miscellaneous areas shall be paid for as "Machine Grading, Special" and will not be paid for separately unless there are items in the contract specific to these types of work.

“Machine Grading, Special” includes the removal of any surface feature located within the grading limits which must be removed and for which there is no specific pay item established in the proposal for its removal.

7. Protection of the Grade - The work shall be kept well drained at all times. Foundation, roadway embankment or subgrade that becomes damaged by rain shall be undercut and backfilled, or otherwise remedied, by the Contractor, at his/her sole expense, as directed by the Engineer.

The Contractor shall be responsible for the maintenance of the foundation, roadway embankment, and subgrade. Any damage caused, by traffic or the Contractor's operations, to the foundation, roadway embankment or subgrade, in the opinion of the Engineer, shall be remedied by the Contractor at his/her sole expense, as directed by the Engineer.

The Contractor shall not use rubber-tired equipment on the foundation, roadway embankment, or subgrade, when its use causes, in the opinion of the Engineer, unnecessary damage to the foundation, road embankment or subgrade. The Contractor shall conduct his/her operations and provide the necessary equipment to ensure the satisfactory completion of the work without damaging the foundation, roadway embankment or subgrade. This may require the transporting and movement of materials over additional distances.

At various times throughout the work, the Engineer may direct the Contractor to use smaller and/or lighter equipment, and to defer certain work tasks, in order to protect the grade and/or adjacent areas. The Contractor shall not be entitled to an extension of time or any additional compensation for the use of smaller equipment, lighter equipment, or work task deferral.

8. Removal of Cable, Conduits and Pipe - The Contractor shall remove, and properly dispose of off-site, all abandoned cables, conduit, and pipe encountered at, or above the bottom of any earthwork excavation or undercut. Where the inverts of abandoned, or to be abandoned or removed, conduits or pipe are less than 16 inches below the bottom of any earth excavation or undercut, the conduits and/or pipe shall be removed and the resulting void filled with an Engineer approved material. The fill material shall be compacted to 95% of its maximum unit weight in lifts not exceeding 12 inches. No separate payment will be made for removal of conduit or pipe, or any of the work, described in this section.

9. Foundation Preparation - Foundation is defined as the original earth grade upon which roadway embankment is placed. The foundation work shall be completed in accordance with subsection 205.03.A (Preparing Roadway Foundation) of the MDOT 2012 Standard Specifications for Construction as shown on the plans, and as specified herein.

The foundation shall be compacted to 95% of its maximum unit weight, as measured by the AASHTO T-180 method, to a depth of at least 10 inches. If this cannot be achieved, in the opinion of the Engineer, he/she will direct the Contractor to perform “Subgrade Undercutting, Type ___” or “Subgrade Manipulation,” as described herein, on the foundation.

10. Roadway Embankment Construction - Roadway embankment is defined as the construction of earth on the prepared foundation to form the subgrade. Roadway embankment work shall be completed in accordance with subsection 205.03 H (Roadway Embankment) of the MDOT 2012 Standard Specifications for Construction as shown on the

plans, and as specified herein. Roadway embankment shall be compacted to a minimum of 95% of its maximum unit weight, as measured by the AASHTO T-180 method.

11. Subgrade Construction - Subgrade is defined as the final earth grade which extends from grading limit to grading limit. The subgrade shall be constructed by performing earth excavation and roadway embankment work in accordance with subsection 205.03.G (Earth Excavation) and subsection 205.03 H (Roadway Embankment) of the MDOT 2012 Standard Specifications for Construction, as shown on the plans, and as specified herein.

The subgrade shall be constructed to the contours and cross-sections shown on the plans, as specified herein, and as directed by the Engineer. To achieve this, the work shall include, but not be limited to:

- A. Removal and disposal off-site of any surplus or unsuitable materials.
- B. Furnishing from off-site any additional Engineer approved fill materials necessary.
- C. Moving existing and/or furnished materials longitudinally and transversely as necessary.
- D. Cutting, placing, compacting, and trimming existing and/or furnished materials to construct the roadway embankment and subgrade to the specified tolerances.
- E. Stockpiling, and moving again, any cut materials which cannot be immediately placed upon excavation due to construction staging.

The subgrade shall be graded to accommodate all subbases and aggregate bases wherever used, all bioswale and adjacent planting beds, all roadway pavements, curb and gutter, driveways, sidewalks, bicycle paths, other similar structures, bioswale planting mix, topsoil and any other features which the subgrade supports.

The subgrade shall be prepared so as to ensure uniform support for the pavement structure. The finished subgrade shall be placed to within 1 inch below and $\frac{3}{4}$ inch above plan grade. Variations within this tolerance shall be gradual.

The subgrade shall be compacted to a minimum of 95% of its maximum unit weight, as measured by the AASHTO T-180 method, to a depth of 10 inches. If this cannot be achieved, in the opinion of the Engineer, he/she will direct the Contractor to perform "Subgrade Undercutting, Type ___" or "Subgrade Manipulation" as described herein.

The Contractor shall use equipment and methods of construction best suited, in the opinion of the Engineer, to the earthwork operations being performed and the project requirements. The use of various equipment and methods of construction are subject to the approval of the Engineer. The Engineer may disallow the use of certain equipment and methods of construction and require the use of other equipment and/or methods of construction. No additional compensation or extensions of contract time will be allowed for additional measures that are required for the protection of the grade as specified herein.

13. Test Rolling - The Contractor shall test-roll the foundation and/or subgrade with a pneumatic tired roller with a suitable body for ballast loading and a gross load capacity that can be varied from 25 and 40 tons. In lieu of this test roller, with the approval of the Engineer, the Contractor may use a fully loaded single axle or tandem axle dump truck.

14. Subgrade Undercutting - "Subgrade Undercutting" shall be performed on the foundation or subgrade in accordance with section 205.03.E (Subgrade Undercutting) of the MDOT

2012 Standard Specifications for Construction, as shown on the plans, as specified herein, and as directed by the Engineer.

15. Subgrade Manipulation - "Subgrade Manipulation" shall be performed on the foundation or subgrade in accordance with section 205.03.F (Subgrade Manipulation) of the MDOT 2012 Standard Specifications for Construction, as shown on the plans, as specified herein, and as directed by the Engineer.

Where subgrade manipulation is required, the foundation or subgrade shall be thoroughly scarified, blended, and mixed to a depth of 12 inches. The work shall be accomplished by means of a large diameter disc, motor grader, or other equipment approved by the Engineer.

After the foundation or subgrade has been manipulated to the satisfaction of the Engineer and allowed to dry, the soil shall be compacted to 95% of its maximum dry density as measured by the AASHTO T-180 method. The time required for drying the soil will not be a basis for an extension of time.

The cost of Subgrade Manipulation shall be included in the cost of "Machine Grading, Special" unless a pay item for "Subgrade Manipulation" is included in the Contract documents.

16. Rock Excavation - Rock excavation shall be performed in accordance with section 205.03.B (Rock Excavation) of the MDOT 2012 Standard Specifications for Construction, as shown on the plans, and as directed by the Engineer.

The pay item "Rock Excavation" will apply only to boulders over ½ cubic yard in volume. Boulders will be measured individually and the volume computed from the average dimension measured in three directions. The removal of rocks, concrete and masonry less than ½ cubic yard in volume shall not be included in the pay item "Rock Excavation," but shall be included in the pay item "Machine Grading, Special."

If the proposal does not include a pay item for "Rock Excavation," rocks measuring over ½ cubic yard in volume shall be paid for as extra work.

17. Lowering Structures - Prior to cutting the subgrade, the Contractor shall remove structure covers, lower the structures to a point between 8 inches and 12 inches below the proposed subgrade, and cover the structures with a steel plate. Structures shall not be raised prior to placing roadway embankment.

The steel plates for covering structure openings shall conform to the plan detail, be pegged and properly placed to prevent their movement under all traffic, be thick enough to carry all traffic, and prevent the infiltration of debris into the structures.

The Contractor shall lower valve boxes to a point between 8 inches and 12 inches below the proposed subgrade. Valve boxes shall not be raised prior to placing roadway embankment.

The void in the grade above the steel plates used for structure lowering and valve box lowering shall be backfilled, and compacted to 95% of its maximum dry density, with an Engineer approved coarse aggregate.

The Contractor shall coordinate the lowering of private utility structures with the private utility companies.

18. Structure Covers - As directed by the Engineer and within two days of their removal, the Contractor shall stockpile on-site, in a location that is mutually agreeable to the Engineer and Contractor, the existing structure covers. The City of Ann Arbor's forces will pick-up the structure covers at a time that is convenient to them and mutually agreeable to the Contractor. The Contractor shall provide the equipment and manpower to load the castings on the City's vehicle(s) so that they can be removed from the site by the City.

19. Structure and Sewer Cleanliness - All sewers, and structures, including manholes, gate wells, valve boxes, inlet structures and curbs shall be protected from damage and contamination by debris and construction materials. Structures shall be maintained clean of construction debris and properly covered at all times during the construction. The Contractor shall immediately clean any structures and/or sewers that become contaminated with construction debris. The Contractor shall be responsible for all direct and indirect damages which are caused by sewers or structures which have been made unclean or have been damaged by the Contractor.

20. Tree trimming - The Contractor shall coordinate with the City Field Services Unit to schedule trimming of trees by City forces or authorized subcontractor. The Contractor shall not be entitled to an extension of time or any additional compensation for the coordination of this work.

d. Measurement and Payment. The completed work, as described, will be measured and paid for at the contract unit price for the following pay item:

<u>Pay Item</u>	<u>Pay Unit</u>
Machine Grading, Special.....	Square Yard

Measurement for payment for the item **Machine Grading, Special** shall be the computed in square yard quantity of excavated material (soil, rock, brick, etc.) from the top of existing grade down to the bottom of the excavation. Embankment, fill, subgrade protection/maintenance/manipulation, and drainage maintenance will not be paid for separately, and are included in this item of work.

Machine Grading, Special will be measured in area of the feature being constructed by the unit square yard, and include all labor, materials and equipment required to complete the work.

The Contractor shall include all of its costs to complete all of the work in the **Machine Grading, Special** pay item and plan quantities included in the proposal. No additional payment will be made for this work, which is shown on the plans and specified herein as work which needs to be completed, and may not be described as included in the pay item. Plan quantities will be paid for the work, and will only be adjusted due to changes in the limits of the work, as directed by the Engineer, in writing.

The pay item **Machine Grading, Special** shall include all the work specified herein, including, but not limited to, the removal and offsite disposal of any surplus or unsuitable materials and the furnishing from off-site any additional Engineer approved fill materials necessary to construct the embankment and subgrade to the contours and cross-sections shown on the plans.

The Contractor is advised that due to the nature of this project and the probable unsuitability of some or all of the excavated material for use as approved fill material, there may be imbalances

between the amount of earth excavation which is suitable for reuse as embankment, and the amount of embankment needed for the construction activities shown on the plans, or as directed by the Engineer. The Contractor shall make provisions for such imbalances and shall include in the bid price for this work the cost of importing/furnishing, placement, and compaction of the material, as well as the cost of stockpiling and re-handling of imported and/or on-site Engineer approved materials as necessary to complete the work of constructing the embankment and subgrade to the cross sections shown on the plans.

CITY OF ANN ARBOR
DETAILED SPECIFICATION
FOR
SUBGRADE UNDERCUTTING

AA:DAD

1 of 1

02/23/16

a. Description. This work shall include the removal of unsuitable subgrade material(s) which may be susceptible to frost heaving or differential frost action in the areas and limits identified by the Engineer, and backfilling to replace these material(s) and remedy unstable soil conditions. This work shall be done in accordance with section 205 of the Michigan Department of Transportation (MDOT) 2012 Standard Specifications for Construction, as directed by the Engineer, and as modified herein.

b. Materials. Provide materials in accordance with Granular Material Class II and 21AA dense-graded aggregate as specified in section 902 of the MDOT 2012 Standard Specifications for Construction.

c. Construction. Construction methods shall be as described in subsection 205.03.E of the Standard Specifications for Construction, and as directed by the Engineer.

After the pavement has been removed, and/or after rough/finish grading, and/or at the time of proof rolling, the Engineer may inspect the grade to determine the need for, and the limits of, undercuts. After undercut areas are excavated to the depths as directed by the Engineer, the areas shall be trimmed, shaped, evenly graded and re-compacted to not less than 95% of the soils maximum unit weight as determined by the AASHTO T-180 test. The Contractor shall properly dispose of all excess materials.

Backfill areas of Subgrade Undercutting, Type IIA with 21AA dense-graded aggregate, and areas of Subgrade Undercutting, Type IIB with Granular Material Class II, as directed by the Engineer.

d. Measurement and Payment. The completed work, as described, will be measured and paid for at the contract unit price for the following pay item:

<u>Pay Item</u>	<u>Pay Unit</u>
Subgrade Undercutting, Type IIA	Cyd
Subgrade Undercutting, Type IIB	Cyd

Basis of payment shall be as described in subsection 205.04 of the Standard Specifications for Construction.

CITY OF ANN ARBOR
 DETAILED SPECIFICATION
 FOR
SIDEWALK, SIDEWALK RAMP, AND DRIVEWAY APPROACH GRADING

AA:DAD

1 of 1

02/23/16

a. Description. Remove miscellaneous structures and materials and complete all earthwork required to construct the proposed cross sections within the limits shown on the plans or stated in this special provision. All lines and grades will be as shown on the plans and as directed by the Engineer. Complete this work according to the Standard Specifications for Construction, this special provision, and as directed by the Engineer.

b. Materials. Furnish and place required base and embankment materials conforming to the Standard Specifications for Construction as necessary to achieve the required typical cross sections. Excavated material, if suitable, may be used as embankment material as approved by the Engineer.

c. Construction. Complete this work according to applicable sections of the Standard Specifications for Construction. Grading for sidewalks, sidewalk ramp, and driveway approaches includes, but is not limited to, the following work:

1. Stripping and stockpiling topsoil for use in turf establishment as approved.
2. Sawcutting existing pavements and curbs.
3. Removing rocks or boulders less than 0.5 cubic yards in volume.
4. Excavating material to a depth necessary for construction.
5. Disposing of excess and unsuitable material according to Section 205.
6. Furnishing and placing embankment material to the grades necessary for construction.
7. Shaping, grading, and compacting the subgrade and embankment to proposed grades.
8. Furnishing and placing Granular Material, CI II base/bedding material to the required thickness.
9. Shaping, grading, and compacting base/bedding material to proposed grades.
10. Matching new sidewalk, sidewalk ramp, and driveway approach grades with existing grades as required.

d. Measurement and Payment. The completed work, as described, will be measured and paid for at the contract unit prices using the following pay items:

<u>Pay Item</u>	<u>Pay Unit</u>
Grading, Driveway Approach	Square Yard
Grading, Sidewalk	Square Yard
Grading, Sidewalk Ramp	Square Yard

The above items will be measured in area by the unit square yard and will be paid for at their respective contract unit prices, which prices shall be payment in full for all labor, equipment and material needed to accomplish this work.

CITY OF ANN ARBOR
SPECIAL PROVISION
FOR
SOIL EROSION AND SEDIMENTATION CONTROL – INLET FILTER

AA:DAD

1 of 1

04/05/15

a. Description. This work consists of installing and maintaining inlet filters, as shown on the plans, in accordance with Section 208 of the Michigan Department of Transportation (MDOT) 2012 Standard Specifications for Construction and. Filters shall be installed in existing and proposed inlets in order to minimize the erosion of soil and the sedimentation of water courses. The related work includes the installation, maintenance and removal of the filter cloth, cleaning as required during the performance of the project work, removing and disposing of accumulated sediment, and replacement of filters if required by the Engineer so as to provide a properly working inlet filter and a well-drained site.

b. Materials. The inlet filters shall be in accordance with the REGULAR FLOW SILTSACK® manufactured by ACF Environmental (800) 448-3636; FLEXSTORM® Style FX manufactured by Advanced Drainage Systems, Inc. (800) 821-6710; CATCH-ALL® manufactured by Price & Company (866) 960-4300, or Engineer approved equal.

The Contractor shall submit product data sheets and a sample of the filter material for inlet filters for Engineer approval prior to ordering materials.

c. Methods of Construction. The Contractor shall install, maintain, clean, and re-install and/or replace inlet filters in accordance with the manufacturer’s specifications and as directed by the Engineer. The Contractor shall dispose of debris off-site.

d. Measurement and Payment. The completed work, as described, will be measured and paid for at the contract unit price for the following pay item:

<u>Pay Item</u>	<u>Pay Unit</u>
Erosion Control, Inlet Filter	Each

Erosion Control, Inlet Filter will be measured by the unit installed and will be paid for at the contract unit price per each, for which price shall be payment in full for all labor, equipment, and materials needed to furnish, install, maintain, clean and remove the inlet filter, and re-install and/or replace the inlet filter as needed.

CITY OF ANN ARBOR
SPECIAL PROVISION
FOR
GEOSYNTHETIC PAVING LAYER

AA:JN/DAD

1 of 2

03/26/17

a. Description. This work shall consist of prepping the surface, furnishing, and installing a geosynthetic paving layer on the leveling course prior to placing the new HMA top course as shown on the plans.

b. Materials. The asphalt bond coat shall be hot applied asphalt cement meeting grade requirements for AC, AR, or PG specifications. Apply an AC-20, PG 64-22, or 60-80 penetration grade of asphalt for normal installations and temperatures. For applications when temperatures exceed 90 degrees Fahrenheit, use a higher viscosity asphalt. AC-30, PG 70-10 or 40-60 penetration grades are appropriate.

The geosynthetic paving layer shall be a non-woven fiberglass/polyester interlay paving material (F/P Interlayer) or approved equal. It shall be free from any tears or holes that will adversely affect physical properties and in-situ performance after installation.

The minimum physical property requirements of the material are as follows:

Mechanical Property	Test Method	Unit	Typical Value
Tensile Strength, MD	ASTM D5035	Lbf/in	>80
Tensile Strength, CD	ASTM D5035	Lbf/in	>70
Elongation at Maximum Load,	ASTM D5035	%	<5
Asphalt Retention	ASTM D6140	Gal/yd ²	0.18
Melting Point	ASTN D276	°F	>446
Mass per Unit Area	ASTM D5261	Oz.yd ²	4.0

Notes:

- a. MD = Machine Direction (longitudinal to the roll)
- b. CD = Cross Direction (across roll width)
- c. Note: Conditions for tensile strength measurements:
 - a. Sample width: 2 inches Sample Length: 10 inches
 - b. Gage Length: 7 inches Crosshead Speed: 2 inches/minute

The manufacturer shall furnish certified test data showing the material meets the physical and engineering properties of this specification, and furnish a letter of certification shall with each shipment stating the material complies with specification requirements.

c. Construction. A trained and experienced installer certified by the manufacturer or their agent(s) shall install and/or supervise the installation of geosynthetic paving layer material.

Apply geosynthetic material on a clean, dry surface free and clear of all dirt and debris

Apply bond coat using a motorized distributor (spreader) that is capable of adjusting spray rates by 0.10 gal/syd. The valves on the distributor bar must fan in an overlap fashion at the application rate. The recommended application is 0.15 gal/syd. Install geosynthetic material over hot asphalt tack coat.

Place the geosynthetic paving layer material using a tractor or a distributor truck with a fabric

applicator attached to the back. Install paving layer material using mechanically powered equipment, or by hand as required and approved by the Engineer. Mechanical equipment shall be capable of installing rolls 3.0 feet in width. Only install material by hand in areas needing specially cut sections, and/or where mechanically installed methods are not feasible. Use brooms or squeegees to remove any air bubbles and ensure paving layer material is in complete contact with the underlying surface. Cut or smooth folds and wrinkles encountered during lay down operations, and apply additional bond coat material as needed to achieve complete adhesion.

Overlap paving layer material according to the manufacturer's specifications. Overlap the transverse roll ends in the direction of paving operations to avoid pick-up during HMA paving. Apply bond coat to all overlaps to ensure proper adhesion.

d. Measurement and Payment. The completed work, as described, will be measured and paid for at the contract unit price for the following pay item:

<u>Pay Item</u>	<u>Pay Unit</u>
Geosynthetic Paving Layer	Square Yard

Geosynthetic Paving Layer will be measured in place by the square yard and paid for at the contract unit price per square yard. This price shall be payment in full for all labor, equipment, and material needed to accomplish this work. The Engineer will make no allowance for overlaps, splices, or cut off and/or wasted material.

Any deviations, alterations, and/or any work not specifically called for on the plans and determined necessary to install the paving layer as approved by Engineer will not be paid for separately and shall be included in this item of work.

CITY OF ANN ARBOR
 DETIALED SPECIFICATION
 FOR
DRAINAGE AND UTILITY STRUCTURES

AA:DAD

1 of 1

03/23/17

a. Description. This work consists of cleaning, pointing, reconstructing, and temporary lowering drainage and utility (storm, sanitary, and water) structures as required whether shown or not shown on the plans, and as herein provided.

b. Materials. Provide materials in accordance with section 403 of the Michigan Department of Transportation (MDOT) 2012 Standard Specifications for Construction, unless otherwise directed by the Engineer.

c. Construction. Clean, point, reconstruct, and temporary lower drainage and utility structures in accordance with section 403 of the MDOT 2012 Standard Specifications for Construction, and as directed by the Engineer.

Reconstruct drainage and utility structures from the base using precast reinforced concrete units or concrete block masonry.

Point structures by removing loose and damaged mortar, filling joints between concrete and masonry units with new mortar, and striking joints so the exposed surface is smooth and free of voids.

d. Measurement and Payment. The completed work, as described, will be measured and paid for at the contract unit prices for the following pay items:

<u>Pay Item</u>	<u>Pay Unit</u>
Dr Structure, Adj, Add Depth, Modified	Foot
Dr Structure, Cleaning, Modified.....	Each
Dr Structure, Point.....	Each
Dr Structure, Reconstruct	Each
Dr Structure, Temp Lowering, Modified	Each

These items will be measured in place by their respective unit and paid for at their respective contract unit price, which price shall be payment in full for all labor, materials, and equipment needed to accomplish this work.

CITY OF ANN ARBOR
 DETAILED SPECIFICATION
 FOR
STRUCTURE COVERS

AA:DAD

1 of 2

03/08/17

a. Description. This work shall consist of replacing and furnishing frames and covers for utility (storm, sanitary, and water) structures as shown on the Plans and as directed by the Engineer, in accordance with section 403 of the edition of the Michigan Department of Transportation (MDOT) 2012 Standard Specifications for Construction, except as specified herein.

b. Materials. Materials shall meet the requirements of sections 403 and 908 of the MDOT 2012 Standard Specifications. All frames and covers shall conform to the model(s) shown in the table below.

Type of Casting	Associated Pay Item (MDOT Designation)	EJ No.	NEENAH No.
Manhole Frame and Cover	Dr Structure Cover, Special	1040AGS	
Manhole Frame and Cover	Dr Structure Cover, Type B, Modified (Type B)	1040 w/ Type A Cover Type M1	R-1642 w/ Type C Cover Type D Cover
Flat Inlet Frame and Cover	Dr Structure Cover, Type D, Modified (Type D)	5000 w/ Type M2 Sinusoidal Grate	
Inlet/Catch Basin Frame and Cover	Dr Structure Cover, Type E, Modified (Type E)		
Curb Inlet/Catch Basin Frame and Cover	Dr Structure Cover, Type K, Modified (Type K)	7045Z w/ 7045M1 Sinusoidal Grate	R-3249F

All storm covers shall have the lettering "DUMP NO WASTE!" and a fish image. All sanitary and water covers shall have "SEWER" and "W" respectively cast on the surface.

Frames and covers shall have machined bearing surfaces. Covers shall have two (2), 1-inch vent holes located opposite each other and 6-inches from the edge.

Frames and covers for monument and gate (water-valve) boxes will be provided by the City of Ann Arbor. The Contractor shall transport these to the site from the City's W.R. Wheeler Service Center located at 4251 Stone School Road.

c. Construction. Materials shall be stored by the Contractor at locations arranged by the Contractor, subject to the approval of the Engineer. The Contractor shall not store materials or equipment, including metal castings and steel plates, on any lawn area.

The Contractor shall deliver all salvaged covers and castings to the W.R. Wheeler Service Center within two days of their removal.

d. Measurement and Payment. The completed work, as described, will be measured and paid for at the contract unit prices for the following pay items:

<u>Pay Item</u>	<u>Pay Unit</u>
Dr Structure Cover, Special	Each
Dr Structure Cover, Type B, Modified	Each
Dr Structure Cover, Type D, Modified	Each
Dr Structure Cover, Type E, Modified	Each
Dr Structure Cover, Type K, Modified	Each

The unit prices for these items of work shall include all labor, material, and equipment costs to perform all the work specified in the MDOT 2012 Standard Specifications and as modified by this Detailed Specification.

Payment for transporting new and salvaged frames and covers to and from the W.R. Wheeler Center is included in other items of work.

FOUR $\frac{1}{8}$ " DIAMETER HOLES ON
 $33\frac{3}{4}$ " DIAMETER BOLT CIRCLE

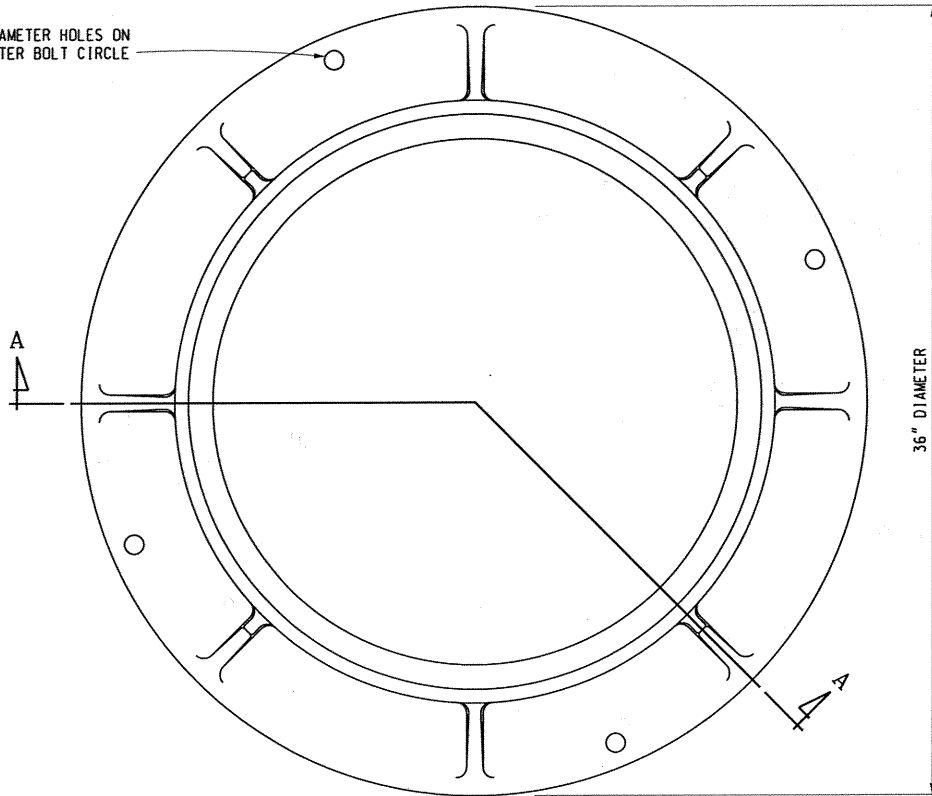

TOP VIEW OF FRAME

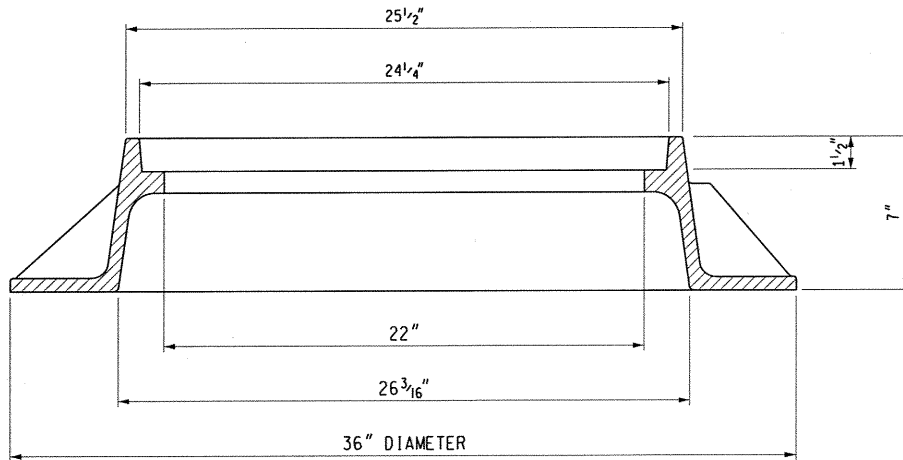

SECTION A - A



PREPARED
 BY
 DESIGN DIVISION

DRAWN BY: B.L.T.

CHECKED BY: W.K.P.

DEPARTMENT DIRECTOR
 Kirk T. Steudle

APPROVED BY: Randy U. Puffel
 DIRECTOR, BUREAU OF FIELD SERVICES

APPROVED BY: Maia A. Van Pelt
 DIRECTOR, BUREAU OF HIGHWAY DEVELOPMENT

MICHIGAN DEPARTMENT OF TRANSPORTATION
 BUREAU OF HIGHWAY DEVELOPMENT STANDARD PLAN FOR

COVER B
 FOR USE ON MANHOLES

9-30-2014
 F.H.W.A. APPROVAL

3-7-2014
 PLAN DATE

R-7-F

SHEET
 1 OF 2

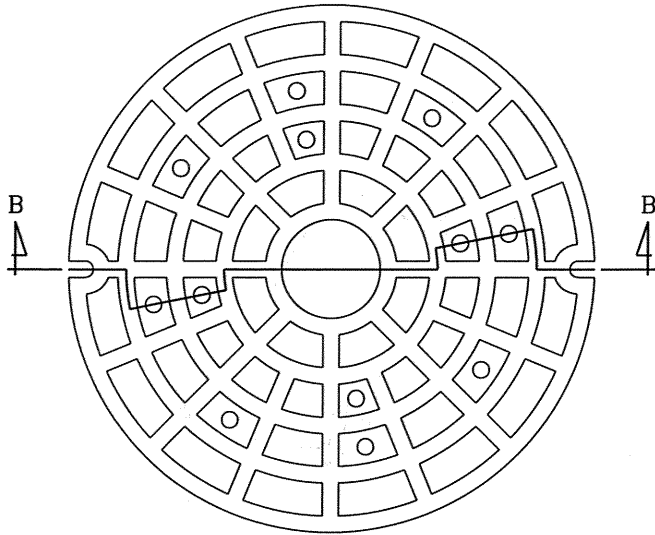

TOP VIEW OF COVER

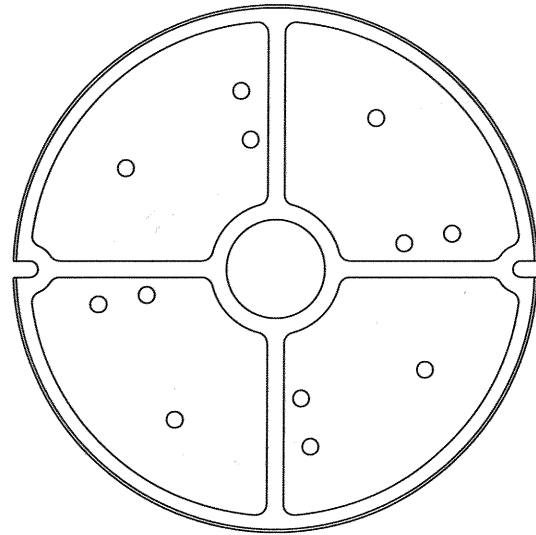

BOTTOM VIEW OF COVER

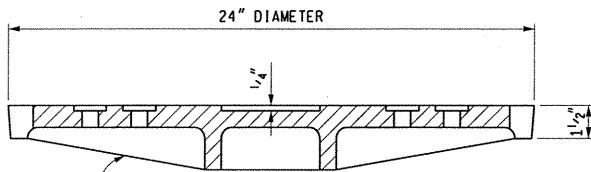

ALTERNATE PROFILES PERMITTED
SECTION B - B

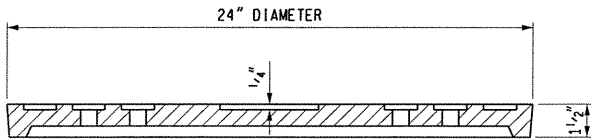

SECTION B - B
ALTERNATE PROFILE EXAMPLE

NOTES:

THE CASTINGS SHALL MEET THE REQUIREMENTS OF THE CURRENT STANDARD SPECIFICATION FOR GRAY IRON CASTINGS.

ALL CASTINGS SHALL BE CLEANED BY CURRENT APPROVED BLASTING METHODS.

THE SEATING FACE OF THE LID AND THE SEAT FOR THE SAME ON THE FRAME SHALL BE GROUND OR MACHINED SO THAT THE LID WILL HAVE AN EVEN BEARING ON ITS SEAT TO PREVENT ROCKING OR TILTING.

THE CASTINGS SHALL BE FREE OF POURING FAULTS, BLOW HOLES, CRACKS AND OTHER IMPERFECTIONS. THEY SHALL BE SOUND, TRUE TO FORM AND THICKNESS, CLEAN AND NEATLY FINISHED, AND SHALL BE COATED WITH COAL TAR PITCH VARNISH.

THIS COVER IS DESIGNED TO FIT ON ANY MANHOLE OR ON ANY EXISTING SIMILAR STRUCTURE WHEN SO DESIGNATED ON THE PLANS.

MICHIGAN DEPARTMENT OF TRANSPORTATION
BUREAU OF HIGHWAY DEVELOPMENT STANDARD PLAN FOR

COVER B
FOR USE ON MANHOLES

9-30-2014
F.H.W.A. APPROVAL

3-7-2014
PLAN DATE

R-7-F

SHEET
2 OF 2

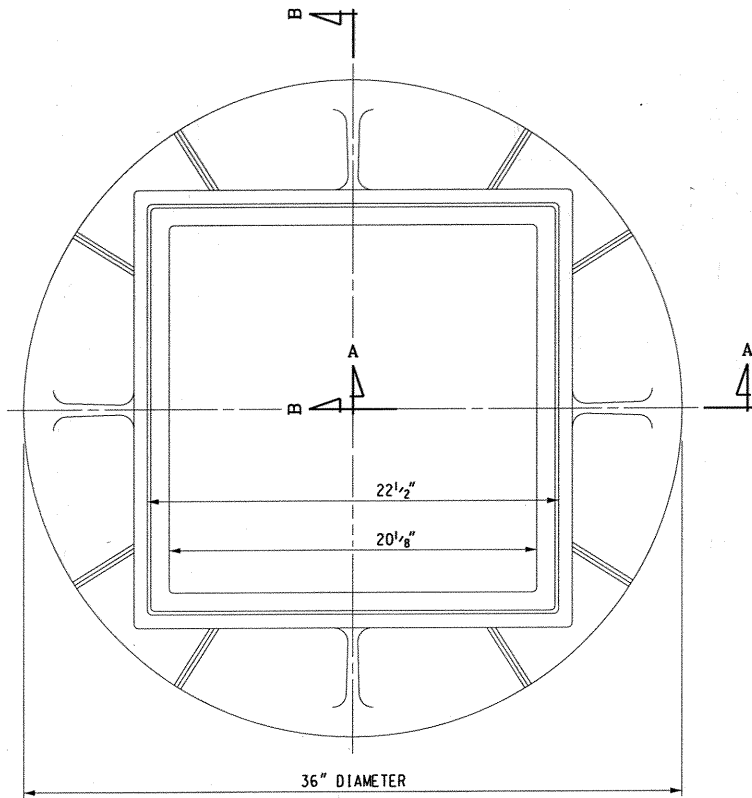

PLAN VIEW OF FRAME

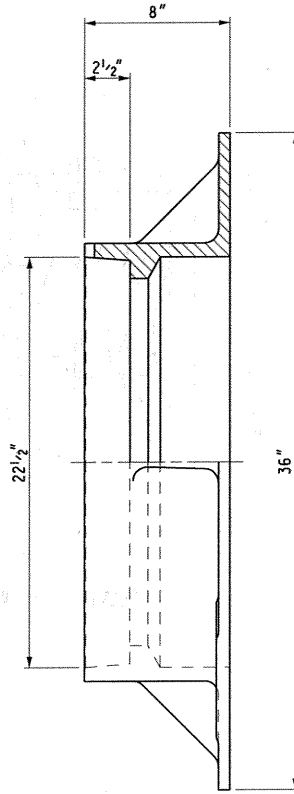

SECTION B - B
HALF FRONT ELEVATION

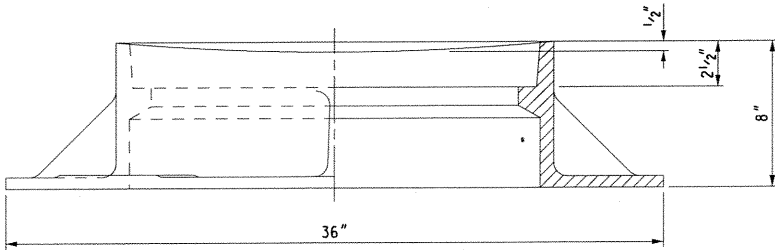

HALF SIDE ELEVATION

SECTION A - A



PREPARED BY
DESIGN DIVISION

DRAWN BY: B.L.T.

CHECKED BY: W.K.P.

DEPARTMENT DIRECTOR
Kirk T. Stuedle

APPROVED BY:

Randy V. Burtfield
DIRECTOR, BUREAU OF FIELD SERVICES

APPROVED BY:

Mark A. Van Pelt
DIRECTOR, BUREAU OF HIGHWAY DEVELOPMENT

MICHIGAN DEPARTMENT OF TRANSPORTATION
BUREAU OF HIGHWAY DEVELOPMENT STANDARD PLAN FOR

COVER D
FOR USE WITH
STRAIGHT CURB AND CURB & GUTTER

9-30-2014
F.H.W.A. APPROVAL

4-29-2014
PLAN DATE

R-9-D

SHEET
1 OF 2

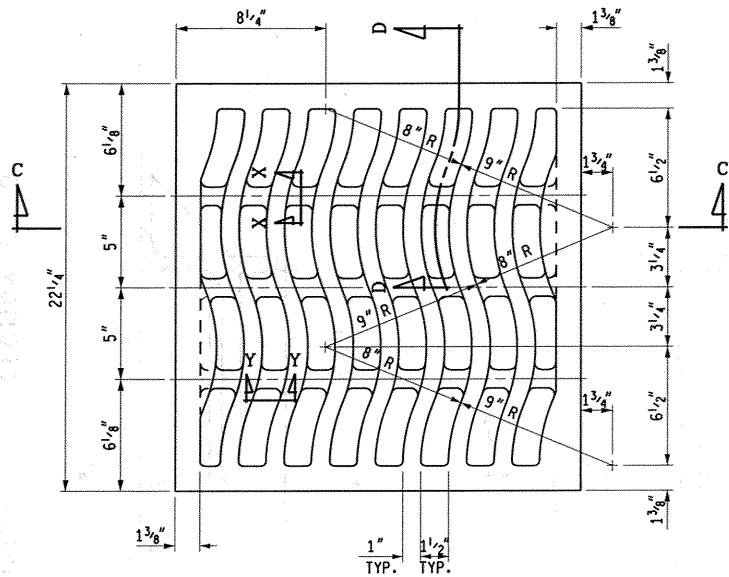

PLAN VIEW OF GRATE

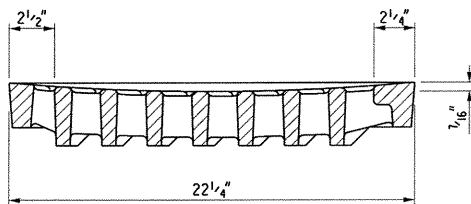
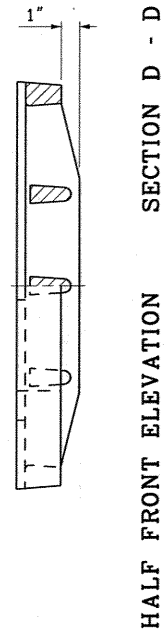

SECTION C - C

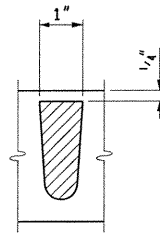

SECTION X - X

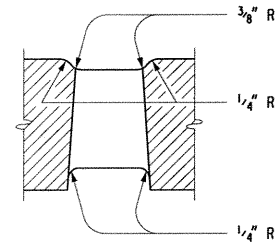

SECTION Y - Y

NOTES:

THE CASTINGS SHALL MEET THE REQUIREMENTS OF THE CURRENT STANDARD SPECIFICATION FOR GRAY IRON CASTINGS.

ALL CASTINGS SHALL BE CLEANED BY CURRENT APPROVED BLASTING METHODS.

THE SEATING FACE OF THE GRATE AND THE SEAT FOR THE SAME ON THE FRAME AND THE CURB BOX SHALL BE GROUND SO THAT THE GRATE WILL HAVE AN EVEN BEARING ON ITS SEAT TO PREVENT ROCKING OR TILTING.

THE CASTINGS SHALL BE FREE OF POURING FAULTS, BLOW HOLES, CRACKS AND OTHER IMPERFECTIONS. THEY SHALL BE SOUND, TRUE TO FORM AND THICKNESS, CLEAN AND NEATLY FINISHED, AND SHALL BE COATED WITH COAL TAR PITCH VARNISH.

THIS COVER IS DESIGNED TO FIT ON ANY INLET, CATCH BASIN OR ON ANY EXISTING SIMILAR STRUCTURE WHEN SO DESIGNATED ON THE PLANS.

MICHIGAN DEPARTMENT OF TRANSPORTATION
BUREAU OF HIGHWAY DEVELOPMENT STANDARD PLAN FOR

COVER D
FOR USE WITH
STRAIGHT CURB AND CURB & GUTTER

9-30-2014
F.H.W.A. APPROVAL

4-29-2014
PLAN DATE

R-9-D

SHEET
2 OF 2

1/4" FILLETS

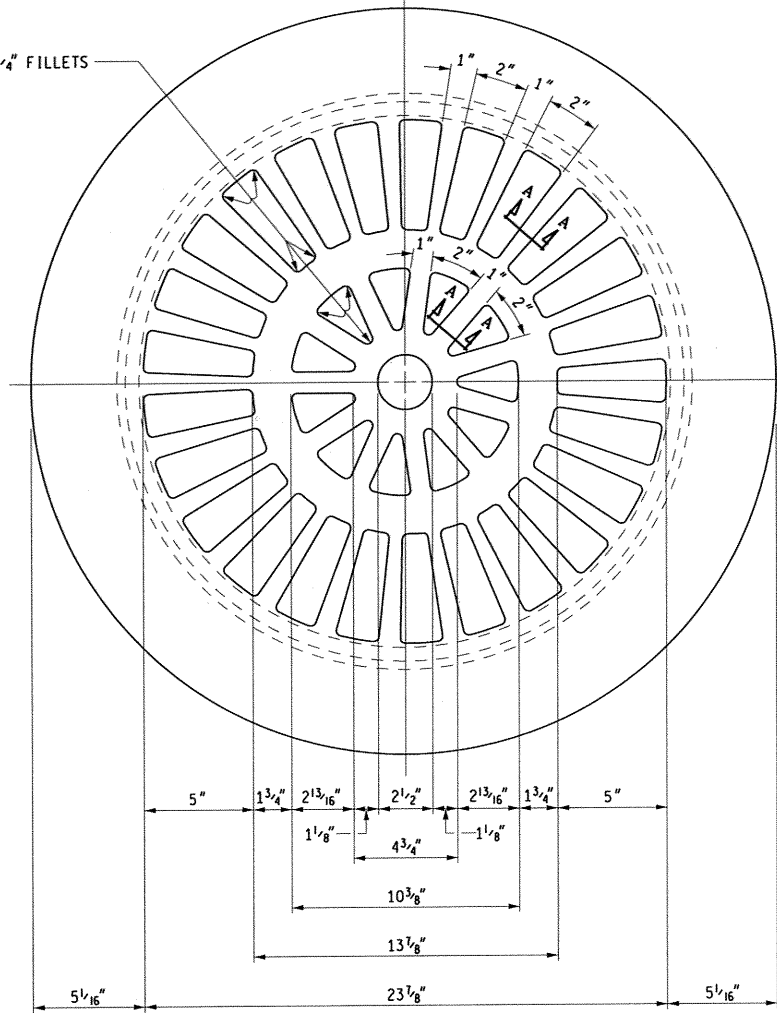

PLAN VIEW

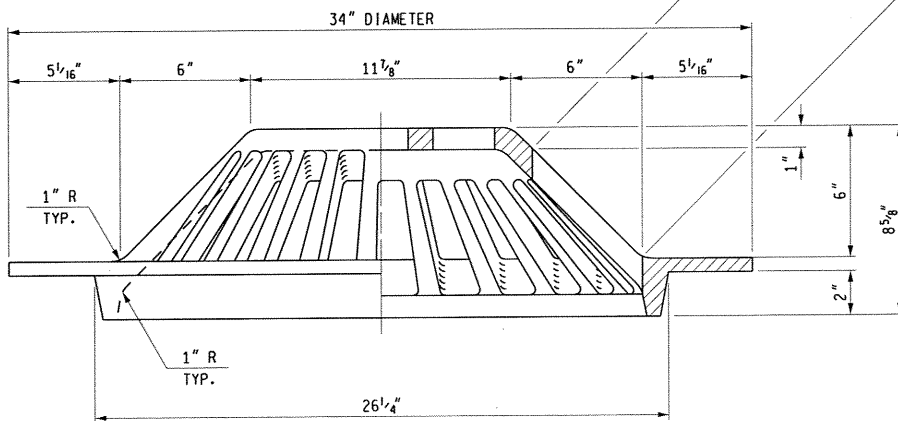

HALF ELEVATION

HALF SECTION

NOTES:

THE CASTINGS SHALL MEET THE REQUIREMENTS OF THE CURRENT STANDARD SPECIFICATION FOR GRAY IRON CASTINGS.

ALL CASTINGS SHALL BE CLEANED BY CURRENT APPROVED BLASTING METHODS.

THE CASTINGS SHALL BE FREE OF POURING FAULTS, BLOW HOLES, CRACKS AND OTHER IMPERFECTIONS. THEY SHALL BE SOUND, TRUE TO FORM AND THICKNESS, CLEAN AND NEATLY FINISHED, AND SHALL BE COATED WITH COAL TAR PITCH VARNISH.

THE CASTING SHALL BE SET IN SOFT MORTAR BED TO THE ELEVATION SPECIFIED ON THE PLANS AND IN SUCH A MANNER AS TO PROVIDE A FIRM AND UNIFORM BEARING ON THE MASONRY WALL.

THIS COVER IS DESIGNED TO FIT ON ANY INLET, CATCH BASIN OR ON ANY EXISTING SIMILAR STRUCTURE WHEN SO DESIGNATED ON THE PLANS.

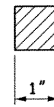

SECTION A-A

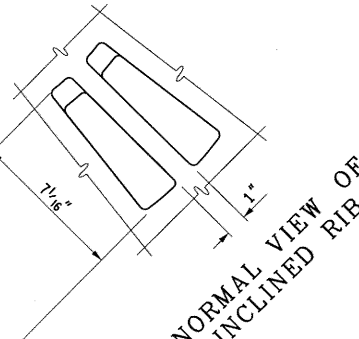

NORMAL VIEW OF INCLINED RIB



PREPARED BY
BY
DESIGN DIVISION

DRAWN BY: B.L.T.

CHECKED BY: W.K.P.

DEPARTMENT DIRECTOR
Kirk T. Stuedle

APPROVED BY: *Randy V. Butcher*
DIRECTOR, BUREAU OF FIELD SERVICES

APPROVED BY: *Neil A. Van Park*
DIRECTOR, BUREAU OF HIGHWAY DEVELOPMENT

MICHIGAN DEPARTMENT OF TRANSPORTATION
BUREAU OF HIGHWAY DEVELOPMENT STANDARD PLAN FOR

COVER E

FOR USE ON STRUCTURES IN DITCHES
WHERE NOT SUBJECT TO TRAFFIC

9-30-2014
F.H.W.A. APPROVAL

4-16-2014
PLAN DATE

R-10-D

SHEET
1 OF 1

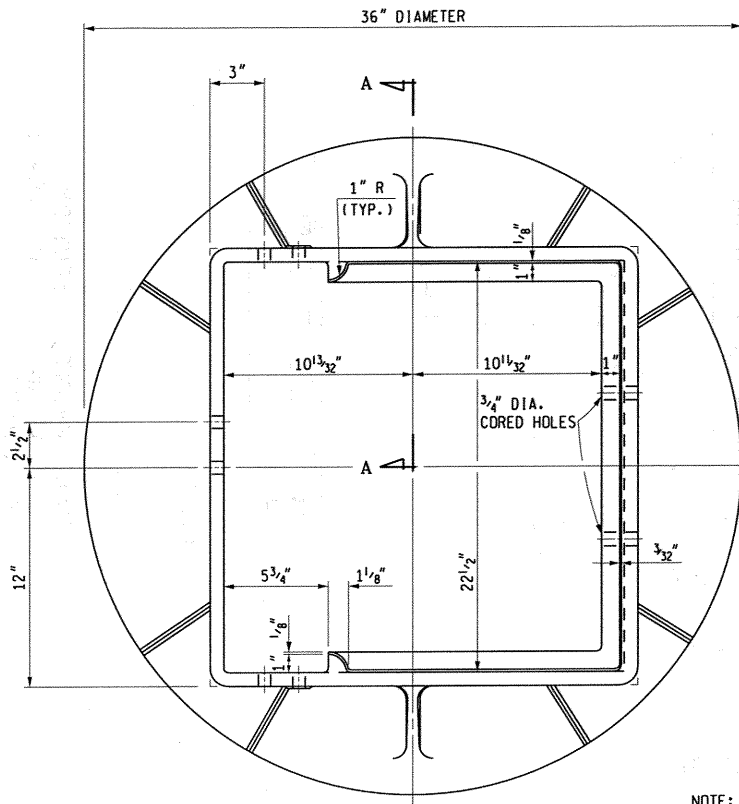

PLAN VIEW OF FRAME

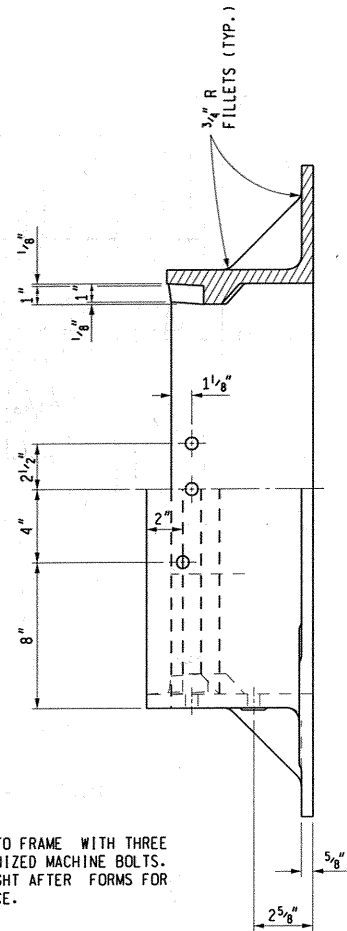

SECTION A - A
OF FRAME

HALF FRONT ELEVATION
OF FRAME

NOTE:
BOLT CURB BOX TO FRAME WITH THREE
5/8" x 2 1/2" GALVANIZED MACHINE BOLTS.
ADJUST FOR HEIGHT AFTER FORMS FOR
CURB ARE IN PLACE.

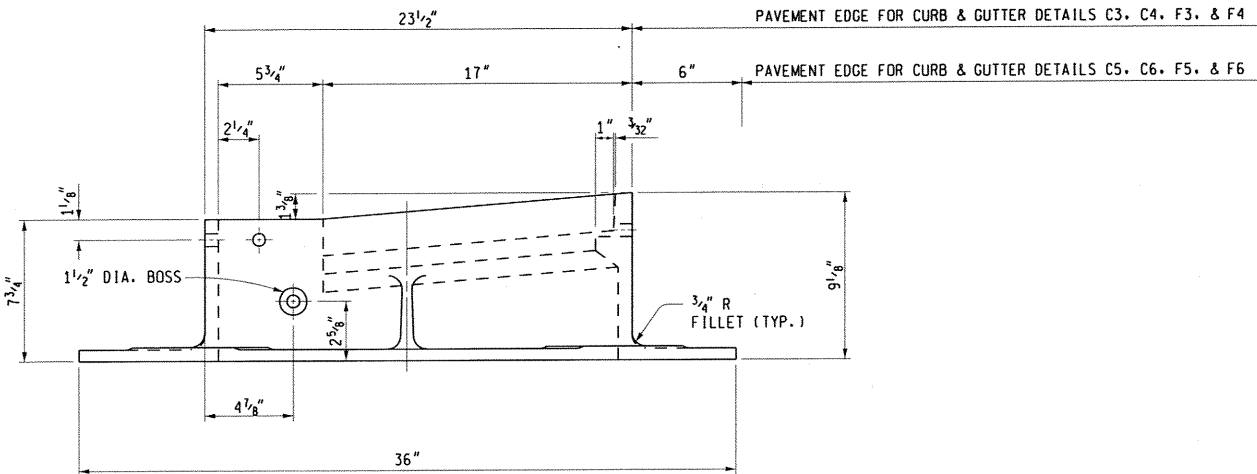

SIDE ELEVATION OF FRAME



PREPARED
BY
DESIGN DIVISION

DRAWN BY: B.L.T.

CHECKED BY: W.K.P.

DEPARTMENT DIRECTOR
Kirk T. Steudle

APPROVED BY: *Randy V. Puffel*
DIRECTOR, BUREAU OF FIELD SERVICES

APPROVED BY: *Maria Van Park*
DIRECTOR, BUREAU OF HIGHWAY DEVELOPMENT

MICHIGAN DEPARTMENT OF TRANSPORTATION
BUREAU OF HIGHWAY DEVELOPMENT STANDARD PLAN FOR

COVER K
FOR USE WITH CONCRETE CURB & GUTTER
DETAILS C, E & F

9-30-2014
F.H.W.A. APPROVAL

4-8-2014
PLAN DATE

R-15-F

SHEET
1 OF 3

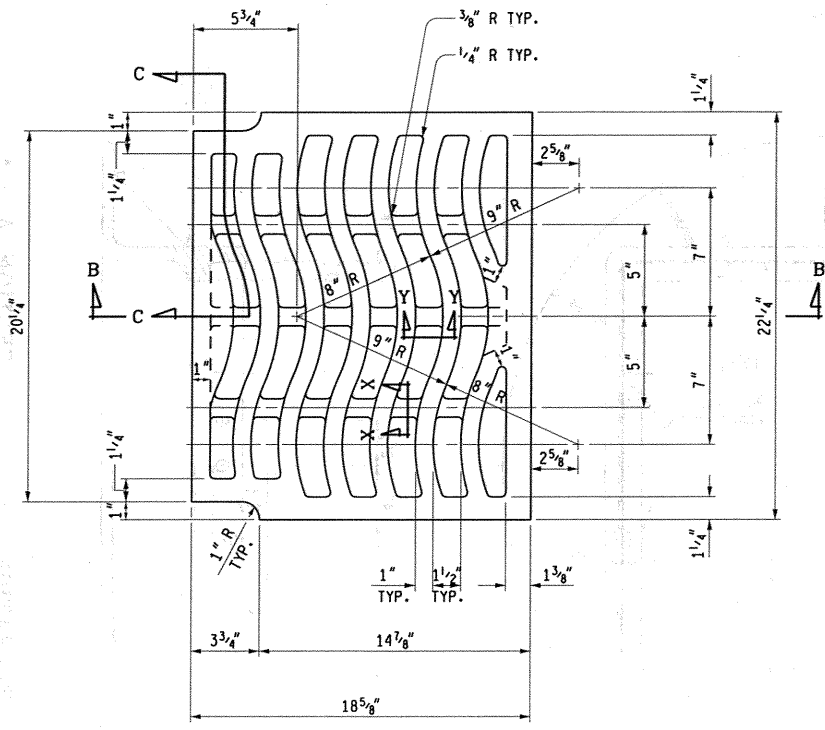

PLAN VIEW OF GRATE

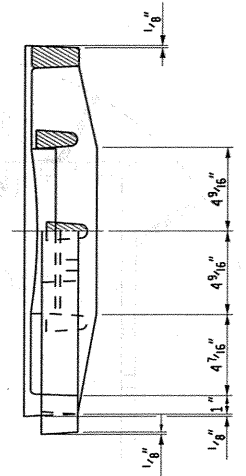

SECTION C - C
HALF FRONT
ELEVATION
OF GRATE

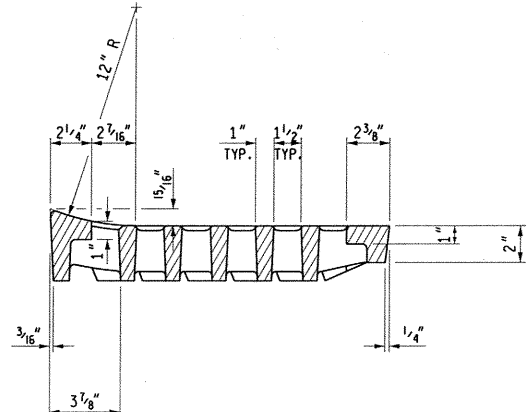

SECTION B - B

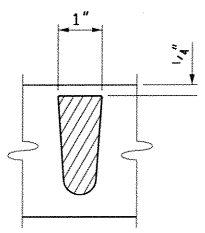

SECTION X - X

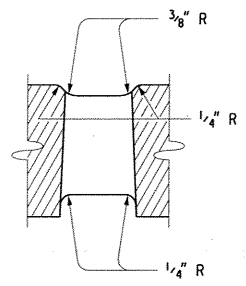

SECTION Y - Y

MICHIGAN DEPARTMENT OF TRANSPORTATION
BUREAU OF HIGHWAY DEVELOPMENT STANDARD PLAN FOR

COVER K
FOR USE WITH CONCRETE CURB & GUTTER
DETAILS C, E & F

9-30-2014 F.H.W.A. APPROVAL	4-8-2014 PLAN DATE	R-15-F	SHEET 2 OF 3
--------------------------------	-----------------------	--------	-----------------

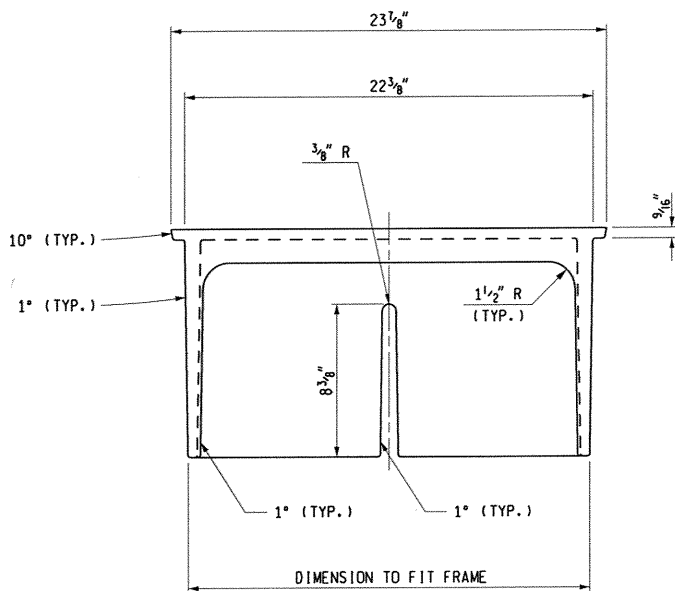

FRONT VIEW OF CURB BOX

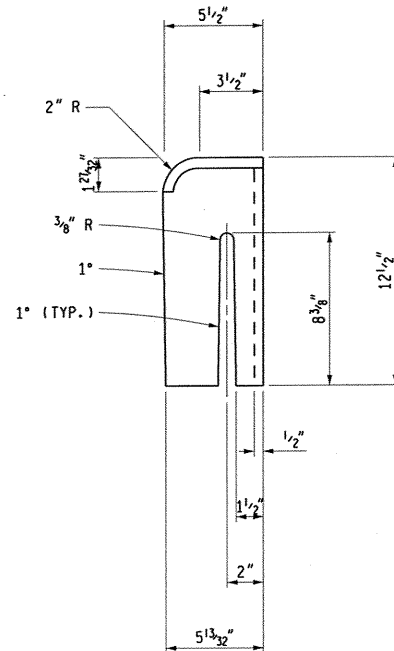

SIDE VIEW

NOTES:

THE CASTINGS SHALL MEET THE REQUIREMENTS OF THE CURRENT STANDARD SPECIFICATION FOR GRAY IRON OR DUCTILE IRON CASTINGS.

ALL CASTINGS SHALL BE CLEANED BY CURRENT APPROVED BLASTING METHODS.

THE SEATING FACE OF THE GRATE AND THE SEAT FOR THE SAME ON THE FRAME SHALL BE GROUND OR MACHINED SO THAT THE GRATE WILL HAVE AN EVEN BEARING ON ITS SEAT TO PREVENT ROCKING OR TILTING.

THE CASTINGS SHALL BE FREE OF POURING FAULTS, BLOW HOLES, CRACKS AND OTHER IMPERFECTIONS. THEY SHALL BE SOUND, TRUE TO FORM AND THICKNESS, CLEAN AND NEATLY FINISHED, AND SHALL BE COATED WITH COAL TAR PITCH VARNISH.

THE CURB BOX AND FRAME SHALL BE SHIPPED ASSEMBLED.

THIS COVER IS DESIGNED TO FIT ON ANY INLET, CATCH BASIN OR ON ANY EXISTING SIMILAR STRUCTURE WHEN SO DESIGNATED ON THE PLANS.

MICHIGAN DEPARTMENT OF TRANSPORTATION
BUREAU OF HIGHWAY DEVELOPMENT STANDARD PLAN FOR

COVER K
FOR USE WITH CONCRETE CURB & GUTTER
DETAILS C, E & F

9-30-2014
F.H.W.A. APPROVAL

4-8-2014
PLAN DATE

R-15-F

SHEET
3 OF 3

CITY OF ANN ARBOR
SPECIAL PROVISION
FOR
ADJUSTING STRUCTURE COVERS

AA:DAD

1 of 2

03/27/17

a. Description. This work shall include the final adjustment of all drainage and utility structure covers in accordance with section 403 of the Michigan Department of Transportation (MDOT) 2012 Standard Specifications for Construction, as shown on the plans, and as specified herein. Utility structures comprise gate valve wells/manholes, sanitary sewer manholes, gate valve boxes, monument boxes, and electrical/traffic signal handholes.

The Contractor shall also be required to coordinate the adjustment of private utility structure covers and ensure that the adjustment has been properly performed with the respective utility prior to placing any final paving materials.

b. Materials. In hot mix asphalt (HMA) pavement areas, adjustments shall be made using MDOT P-NC concrete (658 lbs/cyd) as specified in section 601 of the MDOT 2012 Standard Specifications for Construction. In areas of concrete pavement, adjustments shall be made at the time of paving and encased with the grade of concrete used in the roadway.

c. Construction. Structure covers, monument boxes, water valve boxes and all other public utility underground access or control point covers shall be adjusted to conform to the finished surface section and elevation. The adjusting of covers in lawn areas shall be performed in a one-step process. The adjusting of covers in HMA pavement area shall be performed in two steps: step one is the lowering of the structure cover to below the subgrade elevation and plating of the structure; step two is the final adjustment to finish grade made prior to placing the HMA top course. In areas of concrete pavement, the final adjustment of the structure to finish grade shall be made at the time of concrete pavement forming. All structures in areas of concrete pavement shall be approved by the Engineer prior to the placement of any concrete pavement.

All structures final adjustment is to be to the elevation which results in their top surface being flush with the finished grade. The work is to be accomplished and checked by using a 10 foot straight edge that is placed parallel, and then perpendicular to, the pavement centerline. Failure to meet these conditions will result in the readjustment of the structure and finish patching of the area, as directed by the Engineer, at the Contractor's expense.

All private utility (Electric, Gas, Telecommunications, etc.) structure and valve covers will be adjusted during this project by the Utility. It is the responsibility of the Contractor to coordinate with these private utilities by giving adequate notice and arranging for any adjustment of structures or valves by these utilities. It shall be the sole responsibility of the Contractor to ensure that this work is completed in a timely manner.

The Contractor shall replace existing structures covers, top portions of valve boxes and monument boxes as shown on the plans and as directed by the Engineer.

All existing structure covers removed for salvage shall be stockpiled on site at a location mutually agreed upon by the Contractor and Engineer, and within two days of their removal be delivered to the City's Wheeler Service Center (4251 Stone School Rd, Ann Arbor, MI) by the Contractor.

All adjustments in areas HMA pavement shall be backfilled with Grade P-NC concrete from the depth of excavation necessary for adjustment to an elevation flush with the HMA leveling course. This material shall be included in this item of work and will not be paid for separately.

Structure covers shall be adjusted to between flush and ¼ inch below final pavement surfaces.

d. Measurement and Payment. The completed work, as described, will be measured and paid for at the contract unit prices for the following pay items:

<u>Pay Item</u>	<u>Pay Unit</u>
Dr Structure Cover, Adj, Case 1, Modified	Each
Dr Structure Cover, Adj, Case 2, Modified	Each

Dr Structure Cover, Adj, Case 1, Modified and **Dr Structure Cover, Adj, Case 2, Modified** will be measured and paid for at the respective contract unit prices for each structure that is adjusted, which price shall be payment in full for all labor, equipment and material needed to accomplish this work.

Where the required adjustment of a structure is more than 6 inches above/below the proposed finished grade of the structure, it will be measured and paid for as **Dr Structure Cover, Adj, Add Depth, Modified**. This shall also cover the repair of manholes and structures where less than the substantial rebuilding of the structure, as determined by the Engineer, is required.

There is a possibility that the Contractor may find hidden utility structures during the work. It is the Contractor's responsibility to inform the respective utility owner(s) of the findings. In such instances, the City may direct the Contractor to adjust the structure(s) to grade. This work will be paid as either **Dr Structure Cover, Adj, Case 1, Modified** or **Dr Structure Cover, Adj, Case 2, Modified** depending on the location of the hidden structure(s).

Payment for adjusting for new drainage or utility structures, monuments boxes, and valve boxes shall be included in their respective items of work and will not be paid for under this item. The work for adjusting these items, however, shall be performed in accordance with this detailed specification.

CITY OF ANN ARBOR
DETAILED SPECIFICATION
FOR
DRAINAGE STRUCTURE, DOUBLE INLET

AA:DAD

1 of 1

03/15/16

a. Description. This work consists of constructing double inlet drainage structures as shown on the plans, and as herein provided.

b. Materials. Provide materials in accordance with section 403 of the Michigan Department of Transportation (MDOT) 2012 Standard Specifications for Construction, unless otherwise directed by the Engineer.

c. Construction. Construct double inlet drainage structures in accordance with section 403 of the MDOT 2012 Standard Specifications for Construction, the attached City of Ann Arbor Standard Detail SD-S-11, and as directed by the Engineer.

d. Measurement and Payment. The completed work, as described, will be measured and paid for at the contract unit price for the following pay item:

<u>Pay Item</u>	<u>Pay Unit</u>
Dr Structure, Double Inlet	Each

Dr Structure, Double Inlet will be measured in place respectively by the unit each and paid for respectively at the contract unit price per each, which price shall be payment in full for all labor, materials and equipment needed to accomplish this work.

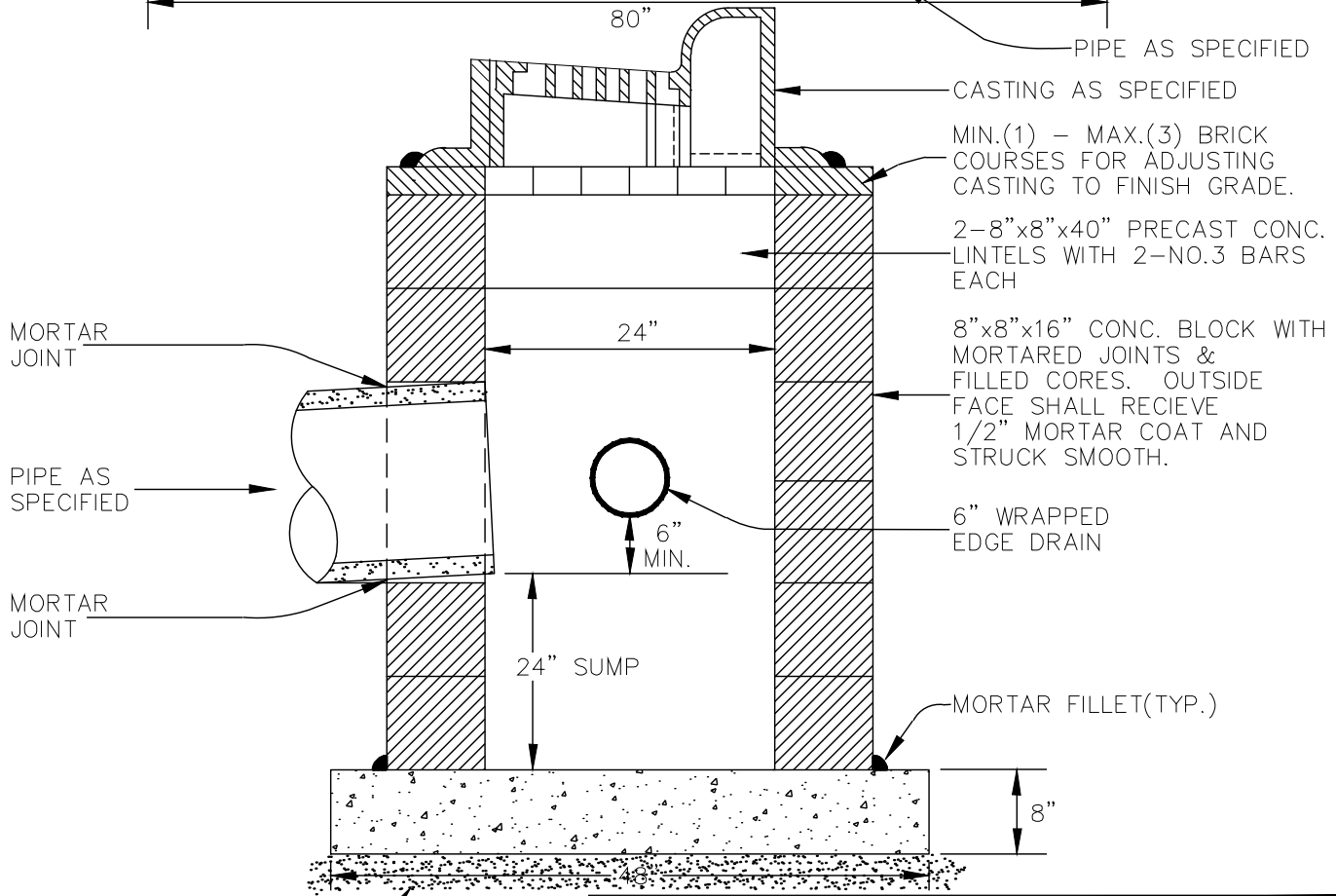
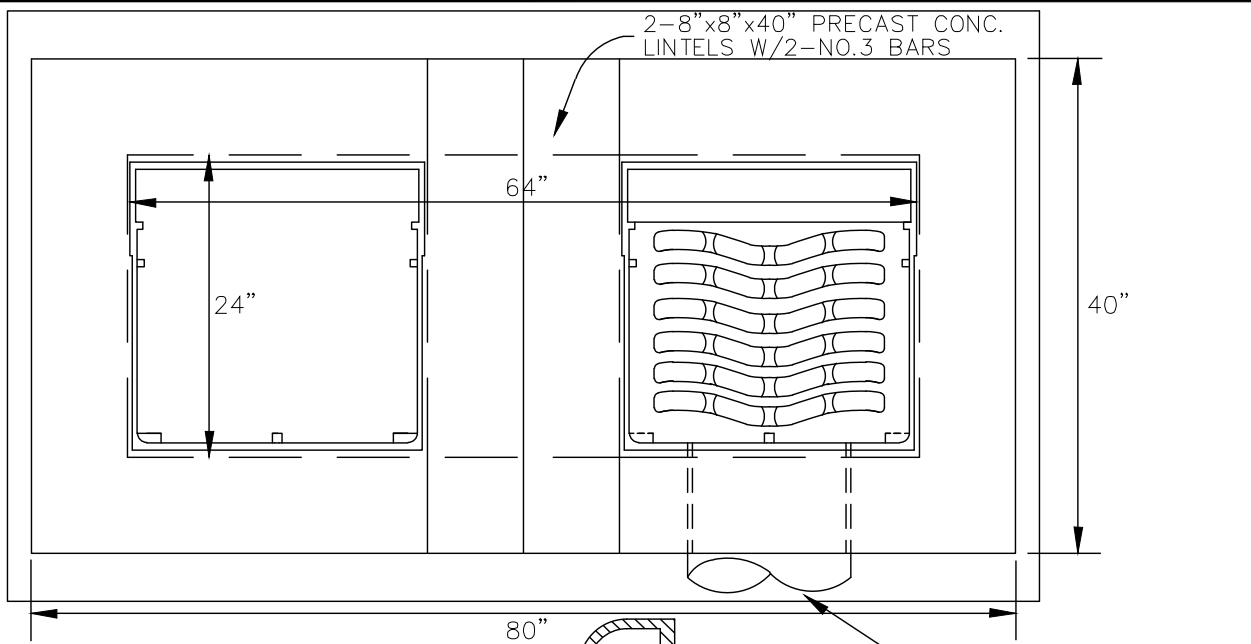

MIN. 4" 21AA STONE BEDDING AND BACKFILL UNDER BASE AND TO FIRST PIPE JOINT.

NOTE: FRONT EDGE OF INLET CASTINGS SHALL BE FLUSH WITH FRONT EDGE OF GUTTER (EDGE-OF-METAL)

CONC. BLOCK REVISED					1	NCF	CSS	1-31-94
REVISIONS					REV. NO.	DR. BY	CH. BY	DATE
PUBLIC SERVICES DEPARTMENT CITY OF ANN ARBOR								
DOUBLE INLET STRUCTURE								
DR. BY	DF/DCO	CH. BY	CSS/DF	DRAWING NO.				
SCALE	NONE	DATE	11-6-92	SD-S-11				
INCH	0  1			SHEET NO. _____ OF _____				

CITY OF ANN ARBOR
DETAILED SPECIFICATION
FOR
SUBGRADE UNDERDRAIN

AA:DAD

1 of 2

04/05/15

a. Description. The work shall include installing 6-inch geotextile-wrapped perforated or slotted underdrain in accordance with attached detail, as shown on the plans, as described herein, and as directed by the Engineer.

b. Material. The materials shall meet the requirements specified in section 404 of the Michigan Department of Transportation (MDOT) 2012 Standard Specifications for Construction, and as specified herein:

Fine Aggregate, 2NS	902
Underdrain Pipe, Perforated or Slotted	909.07.B

Geotextile (Filter Fabric) - The geotextile fabric for encasing the pipe shall be an approved material such as nylon, polypropylene, fiberglass, or polyester and shall be either woven, heat bonded, knitted or of continuous fibers. The geotextile shall completely cover and be secured to the pipe. In an unstretched condition, knitted polyester fabrics shall weigh at least 3.0 ounces per square yard and all other geotextiles shall weigh at least 3.5 ounces per square yard. The fabric shall be strong and tough and have porosity such that the fabric will retain soil particles larger than 0.106 mm (No. 140 sieve) and shall pass aggregate particles finer than 0.025 mm. Geotextiles shall be stored and handled carefully and in accordance with the manufacturer's recommendations and shall not be exposed to heat or direct sunlight to such extent as to significantly affect its strength or toughness. Torn or punctured geotextiles shall not be used.

c. Construction Methods. Geotextile-wrapped underdrain for subgrade drainage shall be installed as shown on the plans and as specified in section 404 of the 2012 MDOT Standard Specifications for Construction, with the following exceptions and additions:

1. The trench shall be constructed to have a minimum width of 18 inches and the underdrain shall be installed at the line grade and depth as indicated on the plans. The contractor shall maintain line and grade by means of a laser. The Engineer will not set line, grade or provide staking.
2. The trench shall then be backfilled with 2NS Fine Aggregate compacted to 95% of its maximum unit weight. The first lift of backfill material shall be placed at a maximum thickness of 6 inches. The second and subsequent lifts, or portions thereof, shall be placed at a maximum thickness of 12 inches up to an elevation level with the bottom of the existing aggregate base course, or as directed by the Engineer.
3. Upgrade ends of the pipe shall be closed with suitable plugs to prevent entrance of any material. All couplings, tees and other fitting shall be manufactured and installed so as to prevent infiltration of any material. If during the course of construction, existing edge drains are encountered; their ends shall be plugged to the satisfaction of the Engineer such that material can not enter the pipe(s).

4. Downgrade ends of the pipe shall generally be tapped into existing or new drainage structures. However, it may be necessary to tap underdrain into either existing or new storm sewer, or into existing or new inlet leads as directed by the Engineer.

5. The trench bottom and edge drain shall be constructed to the percent of grade indicated on the plans or as determined by the Engineer, with the minimum percent of grade being 0.5%. In addition, the underdrain shall be constructed to have a minimum cover, from top of pipe to finished pavement grade, of 36 inches.

6. During the construction of underdrain runs, it may be necessary to terminate construction due to conflicts with buried obstructions or at such time when the minimum cover is reached. The Engineer will review conflicts on a case by case basis and make a decision on whether to continue installing pipe or terminate runs prematurely. The Contract unit price will not be adjusted or additional payments made, for changes in the contract quantity due to Engineer ordered field changes associated when buried obstructions are encountered.

d. Measurement and Payment. The completed work, as described, will be measured and paid for at the contract unit price for the following pay item:

<u>Pay Item</u>	<u>Pay Unit</u>
Underdrain, Subgrade, 6 inch, Special	Foot

Underdrain, Subgrade, 6 inch, Special, will be measured in length by feet and will be paid for at the contract unit price, which price shall be payment in full for all labor, equipment and material needed to accomplish this work.

The unit price shall include the cost of the 6-inch perforated or slotted pipe, geotextile wrap, pipe fittings and/or plugs, 2NS granular bedding material, compaction and trench backfill, taps to new and existing drainage structures and storm sewers or inlet leads, all excavation, final trimming required to meet the dimensions of the typical and specific cross-sections, and the disposal of all surplus excavated materials.

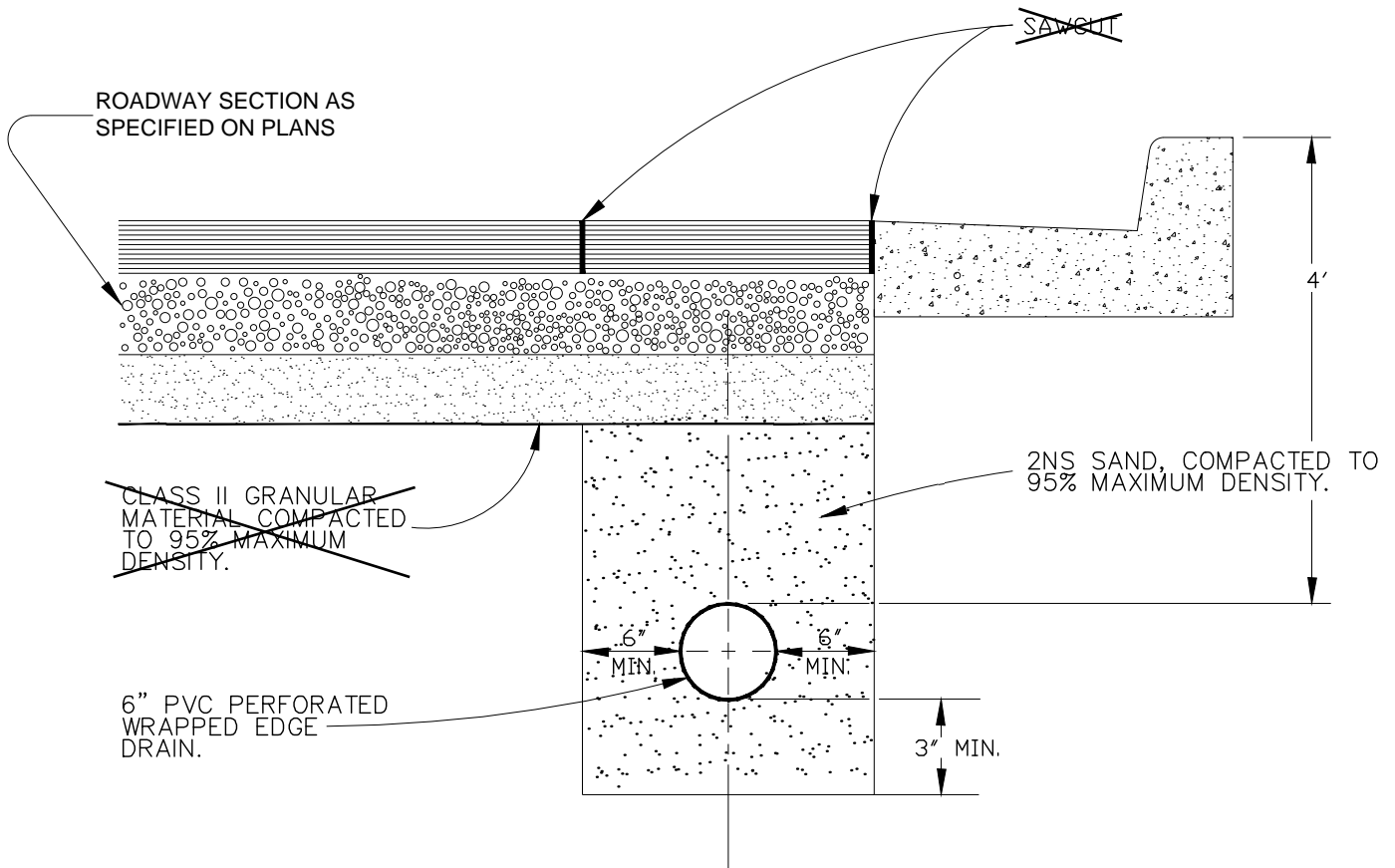

RETITLED	1	NCF	CSS	1-31-94
REVISIONS	REV. NO.	DR. BY	CH. BY	DATE
PUBLIC SERVICES DEPARTMENT CITY OF ANN ARBOR				
EDGE DRAIN TRENCH IN RESURFACED STREET				
DR. BY	DF	CH. BY	CSS	DRAWING NO.
SCALE	NONE	DATE	11-6-92	STD-TD-11 (MODIFIED)
INCH	0  1			SHEET NO. _____ OF _____

CITY OF ANN ARBOR
 DETAILED SPECIFICATION
 FOR
HMA APPLICATION ESTIMATE

AA:DAD

1 of 1

03/27/17

a. Description. Perform this work in accordance with the requirements of section 501 of the Michigan Department of Transportation (MDOT) 2012 Standard Specifications for Construction, and as herein specified.

b. Materials.

PAY ITEM	HMA MIX	APPLICATION RATE	ESTIMATED THICKNESS	PERFORMANCE GRADE	AWI (min)
HMA, 5E3 HMA, 4E3	5E3 (top) 4E3 (leveling) <u>Major Streets</u>	165-220 lb/syd 220-275 lb/syd	1.5-2.0 inches 2.0-2.5 inches	PG 64-28 PG 64-28	260 N/A
HMA, LVSP HMA, LVSP	LVSP (top) LVSP (leveling) <u>Local Streets</u>	220 lb/syd 220 lb/syd	2.0 inches 2.0 inches	PG 58-28 PG 58-28	220 N/A
HMA, Approach	5E3 <u>Major Streets</u> LVSP <u>Local Streets</u>	220 lb/syd	Thickness may vary with maximum layer = 2.0 inches	PG 64-28 PG 58-28	260 220
Shared use Path, HMA	36A	Yield may vary between 165 and 330 lb/syd	Thickness may vary between 1.5 and 3.0 inches	PG 58-28	220
HMA, Wedging, 36A	36A	Yield may vary between 110 and 330 lb/syd	Thickness may vary between 1.0 and 3.0 inches	PG 58-28	220
Hand Patching	5E3 <u>Major Streets</u> LVSP <u>Local Streets</u>	Yield may vary with maximum = 330 lb/syd	Thickness may vary with maximum layer = 3.0 inches	PG 64-28 PG 58-28	N/A

Use the respective mixes indicated above on Major and Local streets unless otherwise noted on plans, or directed by the Engineer.

The Performance Grade asphalt binder range for the HMA mixture shall be as noted above. Apply Bond Coat material accordance with the requirements of the Detailed Specification entitled "HMA Paving". The uniform rate of application shall be a minimum of 0.10 gallons per square yard, and be approved by the Engineer. This work will not be paid for separately, but shall be included in the cost of the HMA pay items.

c. Measurement and Payment. The work shall be measured and paid for as provided elsewhere in the contract documents.

CITY OF ANN ARBOR
DETAILED SPECIFICATION
FOR
HMA PAVING

AA:DAD

1 of 3

03/15/16

a. Description. Hot Mix Asphalt (HMA) pavement base, leveling, and top courses shall be constructed in accordance with section 501 of the Michigan Department of Transportation (MDOT) 2012 Standard Specifications for Construction, except as modified herein, and as directed by the Engineer.

b. Materials. None specified.

c. Construction.

1. Equipment: All equipment shall conform to subsection 501.03.A of the MDOT 2012 Standard Specifications for Construction, except as modified herein.

The Contractor shall have a 10 foot long straight edge, rubber-tired backhoe (Case 580 type, or equivalent), air-compressor with the ability to develop a minimum pressure of 100 pounds per square inch and continuous rated capacity of 150 cubic feet per minute of air flow, and jackhammer available during all paving operations. The Contractor shall be required to perform any miscellaneous cleaning, trimming, material removal, and other tasks as required by the Engineer in order to ensure the proper and orderly placement of all HMA materials on this project.

The Contractor shall provide sufficient rollers to achieve the specified asphalt densities.

At various times throughout the work, the Engineer may direct the Contractor to use smaller and/or lighter equipment, and to defer certain work tasks, in order to protect the grade and/or adjacent areas; including hauling units. The Contractor shall not be entitled to any additional compensation for the use of smaller equipment, lighter equipment, or work task deferral.

2. Cleaning and Bond Coat Application: Cleaning and bond coat application shall be performed in accordance with subsections 501.03.C and 501.03.D of the MDOT 2012 Standard Specifications for Construction, except as modified herein, and as directed by the Engineer.

The Contractor shall furnish and operate throughout the construction period, vacuum-type street cleaning and utility structure cleaning equipment (Vac-All, Vector, etc.) approved by the Engineer, and when directed by the Engineer, for street cleaning immediately prior to, and for street and utility structure cleaning after any and all paving. The cleaning equipment shall be of sufficient power to remove dust, dirt, and debris from the pavement and from utility structures in and adjacent to the construction area. The vac-all or similar equipment and shall be approved by the Engineer prior to beginning the work. The equipment used shall have an effective means for preventing any dust resulting from the operation from escaping into the air.

The bond coat shall be applied at a rate of 0.10 gallons per square yard. Before placing the bond coat, the existing pavement surface shall be thoroughly cleaned. The Contractor shall also thoroughly clean all joints, cracks, and edges to a minimum depth of one inch with compressed air, vac-all type equipment, or other approved mechanical or hand methods, to remove all dirt, debris, and all foreign material.

3. HMA Placement: Placement shall conform to subsection 501.03.F of the MDOT 2012 Standard Specifications for Construction, except as modified herein, and as directed by the Engineer.

HMA placement shall not commence until a "Permit to Place" (no additional costs are required to obtain this permit) has been issued in writing by the Engineer. The Permit to Place shall be issued after the aggregate base course or the adjacent, underlying layer of pavement section has been approved by the Engineer.

The final structure adjustments must be approved by the Engineer prior to the issuance of the "Permit to Place" for the top course.

The top course shall be placed with a ¼" lip at the gutter edge of metal.

All HMA thickness dimensions are compacted-in-place.

4. Paving Operation Scheduling: The Contractor shall schedule the paving operation to avoid longitudinal cold joints that would be required to be left "open" over night.

In all cases, the Contractor shall pave the primary road's through-traffic lanes ("main line") first, from point-of-beginning to the point-of-ending. All other paving including, but not limited to; acceleration and deceleration lanes, intersection approaches, and center left-turn lanes shall be paved following completion of main line paving, unless authorized by the Engineer prior to the placement of any pavement.

5. Rate of Paver Operation: The rate of the paver's travel shall be maintained such that the paving operation will be continuous; resulting in no transverse cold joints, but shall never exceed the rate of 50 feet per minute.

The Contractor shall furnish and operate enough material, equipment, and hauling units so as to keep the paving machine(s) moving continuously at all times. Failure to do so shall be cause for the suspension of the paving operation until the Contractor can demonstrate to the satisfaction of the Engineer, that sufficient resources have been dedicated to perform the work in accordance with the project specifications.

6. Longitudinal and Transverse Joints: These joints shall conform to subsection 502.03.F of the MDOT 2012 Standard Specifications for Construction, and as specified herein.

For mainline HMA paving, the width of the mat for each pass of the paver shall be not less than 10.5 feet, or greater than 15 feet, except as noted in the plans and as directed by the Engineer. The Engineer will direct the layout of all HMA longitudinal joints during construction.

7. Feather Joints – shall be constructed so as to vary the thickness of the HMA from zero inches to the required paving thickness at the rate of approximately 1.5” over a distance of 10 feet, or as directed by the Engineer. The Contractor shall rake the larger pieces of aggregate out of feather joints prior to compaction.

8. Butt Joints: Construction of butt joints, where directed by the Engineer, shall conform to subsections 501.03.C.3 and 501.03.C.4 of the MDOT 2012 Standard Specifications for Construction, except as modified herein.

When a butt joint is specified or directed to be placed by the Engineer, remove the existing HMA surface to the thickness of the proposed overlay, or full-depth, as directed by the Engineer, for the full width or length of the joint. The HMA material shall be sawcut to the directed depth along the pavement edge or removal line to prevent tearing of the pavement surface. Cut joints that will be exposed in the completed surface must be cut with a saw or a cold-milling machine or other methods approved by the Engineer. Joints that will be covered by HMA must be cut with a saw, a cold-milling machine, or other methods approved by the Engineer.

9. Rakers: The Contractor shall provide a minimum of two asphalt rakers during the placement of all wearing and leveling courses.

10. Faulty Mixtures: The Contractor and Engineer shall carefully observe the paving operation for signs of faulty mixtures. Points of weakness in the surface shall be removed or corrected by the Contractor, at his/her sole expense, prior to paving subsequent lifts of bituminous material. Such corrective action may include the removal and replacement of thin or contaminated sections of pavement, segregated HMA, and any sections that are weak or unstable. Once the Contractor or his representative is notified by the Engineer that the material being placed is out of allowable tolerances, or that there is a problem with the paving operation, the Contractor shall stop the paving operation at once, and shall not be permitted to continue placing bituminous material until again authorized by the Engineer. Any costs associated with meeting the requirements specified herein shall not be paid for separately, but shall be included in the item(s) of work being performed at the time the faulty mixture was discovered.

d. Measurement and Payment. Unused HMA remaining in trucks after the work is completed shall be returned to the plant and re-weighed, and the corrected weight slip shall be provided to the Engineer. No payment will be made for the unused HMA material. All weight slips must include the type of mixture (codes are not acceptable), as well as vehicle number, gross weight, tare weight and net weight.

All costs of meeting the requirements of this special provision shall be included in the bid prices for HMA items in the proposal and will not be paid for separately.

CITY OF ANN ARBOR
DETAILED SPECIFICATION
FOR
HMA TRAFFIC CALMING MEASURES

AA:DAD

1 of 1

03/15/16

a. Description. This work consists of constructing traffic calming devices at locations directed by the Engineer, in accordance with the special details shown on the plans, and as described herein.

b. Materials. Provide materials in accordance with section 501 of the Michigan Department of Transportation (MDOT) 2012 Standard Specifications for Construction. Use MDOT mixture HMA, LVSP for this work, or an acceptable substitute approved by the Engineer.

c. Construction. Perform work in accordance with section 501 of the MDOT 2012 Standard Specifications for Construction, and as directed by the Engineer.

Provide a 10-foot long straight-edge and a 10-foot long level during all paving operations.

Clean the existing surface with compressed air and/or vacuum type street cleaning equipment to remove dirt and debris prior to placement of HMA material. Provide compressed air from a source capable of supplying air at a minimum pressure of 90 psi and at a rate 150 cubic feet per minute of at the nozzle.

Apply MDOT SS-1h bond coat on all asphalt and concrete surfaces within the area where the traffic calming measure is to be installed. Apply at a rate of 0.10 gallons/square yard using a power distributor hand sprayer.

Placing traffic calming measure using an asphalt paving machine or, where approved by the Engineer, place HMA material directly by hand. Do not place HMA materials on adjacent pavement surfaces.

Construct traffic calming measures two (2) lifts/layers. Compact each lift of HMA mixture to between 92 and 96 percent (or as determined acceptable by the Engineer) of the theoretical maximum density, as listed on the approved Job Mix Formula. Place permanent thermoplastic pavement markings in accordance with the special detail on the project plans. Permanent thermoplastic pavement markings will be paid separately.

d. Measurement and Payment. The completed work, as described, will be measured and paid for at the contract unit prices for the following pay items:

<u>Pay Item</u>	<u>Pay Unit</u>
HMA, Raised Crosswalk	Square Yard
HMA, Raised Intersection	Square Yard
HMA, Speed Hump	Square Yard

The unit prices for these items of work shall include all labor, material, and equipment costs to perform all work specified in this Detailed Specification.

CITY OF ANN ARBOR
 DETIALED SPECIFICATION
 FOR
HMA, WEDGING, 36A

AA:DAD

1 of 1

03/15/16

a. Description. This work consists of constructing hot mix asphalt (HMA) finish wedges at drive approaches, sidewalk ramps, and any other location(s) directed by the Engineer, and as described herein.

b. Materials. Provide materials in accordance with section 501 of the Michigan Department of Transportation (MDOT) 2012 Standard Specifications for Construction. Use MDOT mixture HMA, 36A for this work, or an acceptable substitute approved by the Engineer.

c. Construction. Perform work in accordance with section 501 of the MDOT 2012 Standard Specifications for Construction, and as directed by the Engineer.

Complete all finish wedging within two days of placing the top course pavement.

Have a 10-foot long straight-edge, backhoe, air-compressor and jackhammer available during all paving operations.

Use finish wedges shall to provide good vertical and horizontal transitions between old and new construction, eliminate areas of standing water in the wearing surface, and allow for positive drainage.

Construct joints by feathering the edges of all finish wedges (including the raking out of all large pieces of aggregate) to provide a high quality, smooth riding surface.

Clean the existing surface with compressed air and/or vacuum type street cleaning equipment prior to placement of wedging material.

Apply MDOT SS-1h bond coat on all asphalt and concrete surfaces within the wedging area at a rate of 0.10 gallons/square yard using a power distributor hand sprayer.

d. Measurement and Payment. The completed work, as described, will be measured and paid for at the contract unit prices for the following pay items:

<u>Pay Item</u>	<u>Pay Unit</u>
HMA, Wedging, 36A	Ton

The unit price for this item of work includes all labor, material, and equipment costs to perform all the work specified in the Standard Specifications and as modified by this Detailed Specification.

Return all unused portions of material loads to the plant for re-weighing. Provide a corrected weight slip to the Engineer. Include type of mixture delivered to the site (codes are not acceptable), as well as vehicle number, gross weight, tare weight, and net weight on all weight slips.

CITY OF ANN ARBOR

DETAILED SPECIFICATION
FOR
REMOVING HOT MIX ASPHALT AROUND STRUCTURE COVERS

AA:DAD

1 of 1

03/15/16

a. Description. This work consists of removing hot mix asphalt (HMA) from around existing (not lowered) structure covers during the cold milling operations as required, whether structures are shown or not shown on the plans, and as herein provided. Covers include those used for storm, sanitary, and water structures, gate and monument boxes, and other private utility structures.

This item does not apply to locations (streets) where structures have been temporary lowered in advance of the cold milling operations.

b. Materials. None specified.

c. Construction. Remove HMA surface around structure covers to the same depth as the cold milled surface without the removal of the aggregate or concrete base. Complete work in accordance with sections 204 and 501 of the MDOT 2012 Standard Specifications for Construction, and as directed by the Engineer.

Remove HMA surface, any thickness, from around existing structure covers using a milling machine, and/or hand tools, or other means as approved by the Engineer. Repair or replacement of any structure covers damaged during this operation is the sole responsibility of the Contractor.

d. Measurement and Payment. The completed work, as described, will be measured and paid for at the contract unit prices for the following pay items:

<u>Pay Item</u>	<u>Pay Unit</u>
HMA Surface, Around Structure Cover, Rem.....	Each

The unit price for this item of work shall include all labor, material, and equipment costs to perform all the work specified in the Standard Specifications and as modified by this Detailed Specification.

The number of castings within the milling limits shall constitute the final amount. Measurement shall take place with both the Engineer and the Contractor (or their agents) present.

CITY OF ANN ARBOR
 DETAILED SPECIFICATION
 FOR
FLOWABLE FILL

AA:DAD

1 of 2

03/15/16

a. Description. This work consists of furnishing and placing flowable fill as backfill material at miscellaneous locations as shown on the plans, and as directed by the Engineer.

b. Materials. Provide flowable fill material, as directed by the Engineer, meeting one the following mixes:

1. Portland cement, fly ash, and water.
2. Portland cement, granular material, fly ash, and water.
3. Fly ash, granular material, and water.

Provide materials in accordance with the following requirements:

		⁽³⁾ <u>Specific Gravity</u>
Portland Cement	MDOT Section 901	3.15
Fly Ash	⁽¹⁾ ASTM C 618(I)	2.40
Granular Material, CI II	⁽²⁾ MDOT Section 902	2.60
Water	MDOT Section 911	1.00

Note: Reference to MDOT relates to applicable sections of the Michigan Department of Transportation 2012 Standard Specifications for Construction.

⁽¹⁾Except there is no limit on the loss of ignition.

⁽²⁾Except that 100% shall pass 3/4-inch sieve.

⁽³⁾Specific gravity values used for mix proportions given. If material used differs from these values make appropriate adjustments as required to achieve an acceptable mixture.

Acceptable mixtures for flowable fill are as follows:

1. FF Mix Number One
 Cement Stabilized Fly Ash Mixture (Class F Fly Ash)

Portland Cement	100 lbs/cyd
Fly Ash (Class F)	2000 lbs/cyd
Water	Sufficient amounts to produce the desired flowability (approx. 80 gal/cyd)

2. FF Mix Number Two
 Controlled Density Fill Mixture (Class F Fly Ash)

Portland Cement	50 lbs/cyd
Fly Ash (Class F)	500 lbs/cyd
Granular Material	2600 lbs/cyd
Water	Sufficient amounts to produce the desired flowability (approx. 50 gal/cyd)

CITY OF ANN ARBOR
DETAILED SPECIFICATION
FOR
FLOWABLE FILL

AA:DAD

2 of 2

03/15/16

- 3. FF Mix Number Three
Controlled Density Fill Mixture (Class C Fly Ash)

Fly Ash (Class C)	300 lbs/cyd
Granular Material	2600 lbs/cyd
Water	Sufficient amounts to produce the desired flowability (approx. 50 gal/cyd)

c. Construction. Furnish and place flowable fill at miscellaneous locations as shown on the plans, and as directed by the Engineer.

All flowable fill, after setting, is intended to be removable by conventional mechanical excavation methods.

d. Measurement and Payment. The completed work, as described, will be measured and paid for at the contract unit prices for the following pay items:

<u>Pay Item</u>	<u>Pay Unit</u>
Flowable Fill	Cubic Yard

The unit price for this item of work shall include all labor, material, and equipment costs to perform all the work specified by this Detailed Specification.

Flowable fill used at the Contractor's option will not be paid for separately, but shall be included either in the bid price(s) for the associated work item(s), or in the bid price for the item of work "General Conditions, Max \$___".

CITY OF ANN ARBOR
SPECIAL PROVISION
FOR
CONCRETE PLACEMENT AND PROTECTION

AA:DAD

1 of 2

04/06/15

a. Description. This work shall consist of furnishing all labor, material, and equipment needed to furnish, place, and protect all concrete material in accordance with the requirements of this special provision. These requirements shall not apply to concrete bridge decks, unless otherwise noted.

b. Materials. The concrete shall meet the requirements of sections 601 and 701 of the Michigan Department of Transportation (MDOT) 2012 Standard Specifications for Construction.

The Contractor shall propose specific concrete mix designs for the intended project purpose in accordance with the requirements of this special provision and other applicable special provisions and/or project requirements. The Engineer's acceptance of a mix design shall not relieve the Contractor of their responsibility for the manufacture of the concrete mixture(s), its placement, or performance.

c. Construction. The Contractor shall perform all concrete placement operations in weather that is suitable for the successful placement and curing of the concrete materials. Concrete shall not be placed during periods of active precipitation.

The Contractor shall complete all needed formwork, base and/or sub-base preparation, and any other related items that are deemed necessary for the proper completion of the work. The Contractor shall not commence the placement of concrete until they receive all needed approvals from the Engineer for placement. The Engineer's approval of the Contractor to place concrete shall not relieve the Contractor of their responsibility for the proper placement and protection of the concrete materials or its long-term performance.

During periods when precipitation is threatening, provide durable, plastic sheeting, approved by the Engineer, in sufficient quantity to cover and protect all freshly placed concrete such that precipitation does not come into contact with the concrete. The Contractor shall arrange the placement of the plastic sheeting such that the surface of any freshly placed concrete is not marred by contact with the plastic; any seams in the plastic sheeting shall be water tight. The Contractor shall place adequate supports along and over the freshly placed concrete to prevent contact of the plastic and concrete. The Contractor shall ensure that sufficient dams or barriers are placed along the edges of the freshly placed concrete to prevent erosion of the underlying materials or damage to the edges of the freshly placed concrete. All measures shall be effective.

Any concrete damaged by precipitation shall be removed and replaced at the Contractor's expense. The Engineer shall decide if the concrete has been damaged and the limits of removal and replacement.

Concrete shall only be placed when the rate of surface evaporation at the site is less than 0.20 pounds per square foot per hour, according to figure 706-1 of the MDOT 2012 Standard Specifications for Construction. The Contractor shall provide approved equipment for determining the relative humidity and wind velocity at the site.

Water shall not be added to the placed concrete in order to aid finishing. Any water added to the concrete for slump adjustments shall be done by adding water to the mixing unit and thoroughly re-mixing the concrete for 30 revolutions of the mixing unit at mixing speed. Water shall not be added such that the design water-to-cement ratio of the concrete mixture or the design slump of the concrete mix is exceeded.

Concrete curing shall be performed in accordance with subsection 602.03.M of the MDOT 2012 Standard Specifications for Construction. Curing operations shall take precedence over texturing operations and continued concrete placement. All curing compound applied shall provide uniform coverage over the entire surface being protected. The placement of curing compound shall be free of spots, blotches, or uncovered or non-uniformly covered areas. Should any areas be determined to exist by the Engineer, the curing compound shall be immediately re-applied by the Contractor at no additional cost to the project.

The Contractor shall take all precautions when placing concrete to protect it from damage due to the elements. Concrete shall not be placed during precipitation events.

Concrete shall be protected from weather and temperature according to the requirements of subsection 602.03.T MDOT 2012 Standard Specifications for Construction. Concrete shall not be placed when the temperature of the plastic concrete mixture itself is greater than 90° F. In conditions where low temperature protection is required, the Contractor shall cover the concrete with insulated blankets, or other means as approved by the Engineer, to protect the concrete from damage. The concrete shall remain protected until it has reached a compressive strength of at least 1000 psi, or as directed by the Engineer.

d. Measurement and Payment. All costs associated with the conformance to the requirements of this Special Provision will not be paid for separately, but shall be considered to be included in the respective items of work.

CITY OF ANN ARBOR
 DETAILED SPECIFICATION
 FOR
CONCRETE CURB AND GUTTER, AND DRIVEWAY OPENINGS

AA:DAD

1 of 2

04/06/15

a. Description. This work shall consist of constructing concrete curb and gutter, and concrete driveway openings in accordance with attached details, section 802 of the Michigan Department of Transportation (MDOT) 2012 Standard Specifications for Construction, as shown on the plans, and as specified herein.

b. Materials. The materials shall meet the requirements as specified in section 802 of the MDOT 2012 Standard Specifications for Construction and as specified herein:

The concrete mixture for Driveway Opening, Conc, Det M, Modified shall be Grade P-NC (658 lbs/cyd cement content) concrete with 6AA coarse aggregate.

All other concrete curb and gutter specified herein shall be Grade P1 with 6AA coarse aggregate. The Contractor may elect to add GGBFS to P1 mixtures in accordance with the requirements of the contract documents. No additional payment will be made for concrete mixtures containing GGBFS.

All concrete mixtures shall contain 6AA coarse aggregates which are either natural or limestone and meet the requirements of section 902 the MDOT 2012 Standard Specifications for Construction.

It shall be the Contractor's sole responsibility to propose specific concrete mix designs which meet the requirements of this Detailed Specification.

c. Construction. Construction methods shall be in accordance with section 802 of the MDOT 2012 Standard Specifications for Construction. Curb and Gutter, Conc shall be 2 feet wide barrier curb and gutter and constructed where shown in the plans.

Expansion joints of the thickness shown on the details shall be placed as directed by the Engineer.

d. Measurement and Payment. The completed work, as described, will be measured and paid for at the contract unit prices respectively for the following pay items:

<u>Pay Item</u>	<u>Pay Unit</u>
Curb and Gutter, Conc,.....	Foot
Driveway Opening, Conc, Det M, Modified,	Foot

The pay items will be measured in length by the foot and will be payment in full for all labor, equipment and material needed to properly complete this work.

At curb openings for sidewalk ramps, the concrete curb and gutter (without the curb face) will be measured and paid for at the contact unit price for curb and gutter.

Where the Engineer directs the use of high early strength concrete for pay items that are not specifically designated to use Grade P-NC concrete, the additional cement shall be paid for separately. No additional payment will be made for cement for pay items that are designated to use Grade "P-NC." concrete.

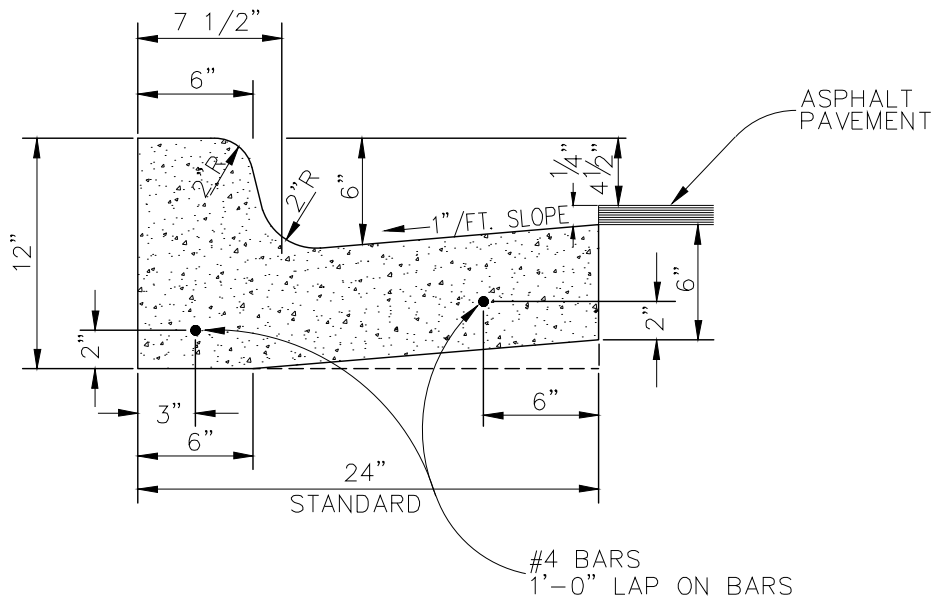

REVISIONS		REV. NO.	DR. BY	CH. BY	DATE
PUBLIC SERVICES DEPARTMENT CITY OF ANN ARBOR					
BARRIER CURB AND GUTTER					
DR. BY	DF	CH. BY	CSS	DRAWING NO.	
SCALE	NONE	DATE	11-6-92	SD-R-1	
INCH	0  1			SHEET NO. _____ OF _____	

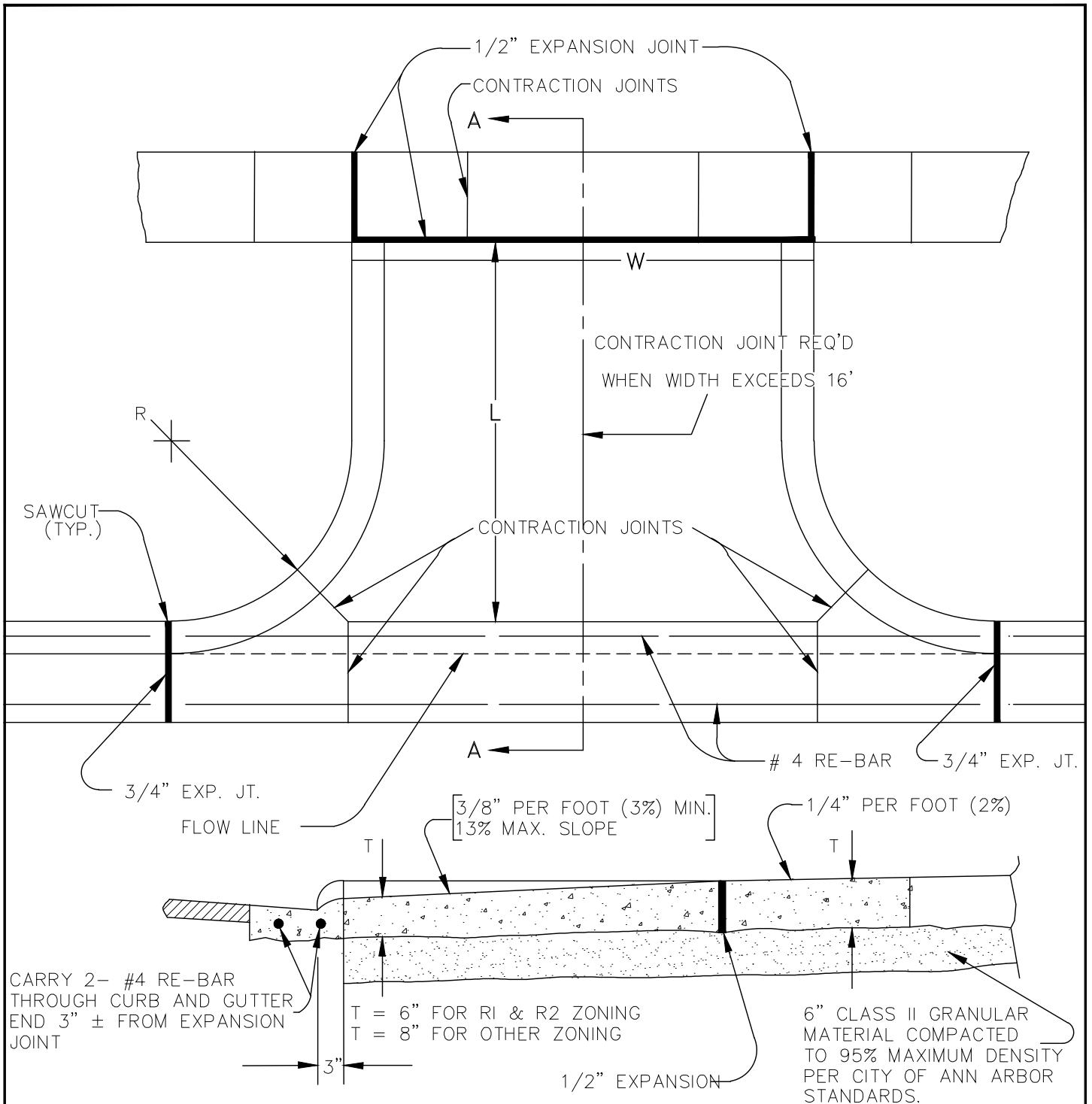

MEASUREMENT OF AREA
 $W \times L = \text{AREA}$

SEC. A - A

NOTE: DRIVE APPROACH TO BE CLASS 'A' CONCRETE

NOTE: R(RADIUS) AND W(DRIVE WIDTH) AS REQUIRED FOR ZONING BY CITY CODE

NOTE: IF GUTTER IS OVERLAYED, GUTTER OF THE APPROACH SHALL BE AT SAME ELEVATION AS EXISTING GUTTER AND ASPHALT WEDGE SHALL BE PLACED IN THE APPROACH.

S/W GRADE REVISED		1	NCF	CSS	1-31-94
REVISIONS		REV. NO.	DR. BY	CH. BY	DATE
PUBLIC SERVICES DEPARTMENT CITY OF ANN ARBOR					
TYPE 'M' DRIVE APPROACH (FOR USE ON ASPHALT STREETS WITH BARRIER CURB)					
DR. BY	DF	CH. BY	CSS	DRAWING NO.	
SCALE	NONE	DATE	11-6-92	SD-R-6	
INCH	0 1			SHEET NO. ____ OF ____	

CITY OF ANN ARBOR
DETAILED SPECIFICATION
FOR
CONCRETE SIDEWALK, SIDEWALK RAMPS, AND DRIVEWAY APPROACHES

AA:DAD

1 of 2

03/22/17

a. Description. This work shall consist of constructing concrete sidewalks, sidewalk ramps, or driveway approaches of the types as indicated on the plans in accordance with attached details, and as directed by the Engineer. All work shall be in accordance with sections 801 and 803 of the Michigan Department of Transportation (MDOT) 2012 Standard Specifications for Construction, and as specified herein.

b. Materials. The materials shall meet the requirements as specified sections 801 and 803 of the MDOT 2012 Standard Specifications for Construction and as required herein. The concrete mixture for driveway approaches shall be Grade P-NC (658 lbs/yd³ cement content) as specified in section 601 of the MDOT 2012 Standard Specifications.

The grade of concrete for all remaining items covered by this Detailed Specification shall be Grade P1 as specified in section 601 of the 2012 MDOT Standard Specifications for Construction. The Contractor may elect to add GGBFS to P1 mixtures in accordance with the requirements of the contract documents. No additional payment will be made for concrete mixtures containing GGBFS.

All concrete mixtures shall contain 6AA coarse aggregates which are either natural or limestone and meet the requirements of section 902 of the MDOT 2012 Standard Specifications for Construction.

It shall be the Contractor's sole responsibility to propose specific concrete mix designs which meet the requirements of this Detailed Specification.

c. Construction Methods. The Contractor is responsible to construct all sidewalks, sidewalk ramps, curbs, and all other concrete items within ADAAG compliance. All sidewalk and curb ramps must be constructed in accordance with MDOT Standard Plan Series R-28.

Where concrete is to be placed, it shall be placed on a minimum of 4 inches of Granular Material Class II compacted to 95% of its maximum dry density.

Prior to placing any concrete, the subgrade shall be completed and trimmed to final elevation. If a cold joint is required, the existing concrete is to be cleaned with compressed air to expose the aggregate in the concrete.

Where indicated on the plans, the Contractor shall horizontally sawcut curbs to provide openings for sidewalk ramps. The Engineer shall define the extent of sawcutting both horizontally and vertically. This work will not be paid for separately, but shall be included in the corresponding price of the ADA ramp to be placed.

All sidewalk ramps shall be installed with detectable warning units. Reference the Detailed Specification entitled "Detectable Warning Surface" for additional requirements.

d. Measurement and Payment. The completed work, as described, will be measured and paid for at the contract unit prices respectively for the following pay items:

<u>Pay Item</u>	<u>Pay Unit</u>
Driveway, Nonreinf Conc, 6 inch, Modified	Square Yard
Driveway, Nonreinf Conc, 8 inch, Modified	Square Yard
Sidewalk, Conc, 4 inch, Modified	Square Foot
Sidewalk, Conc, 6 inch, Modified	Square Foot
Sidewalk, Conc, 8 inch, Modified	Square Foot
Sidewalk Ramp, Conc, 6 inch, Modified	Square Foot
Sidewalk Ramp, Conc, 8 inch, Modified	Square Foot

The above items will be measured by area in square feet and be paid for at their respective contract unit price, which price shall be payment in full for all labor, equipment and material needed to accomplish this work. The unit price shall also include all costs associated with sawcutting curbs to provide openings for sidewalk ramps as indicated on the plans.

Where the Engineer directs the use of high early strength concrete for pay items that are not specifically designated to use Grade "P-NC" concrete, the additional cement shall be paid for separately. No additional payment will be made for cement for pay items that are designated to use Grade "P-NC." concrete.

Excavation for placement of Granular Material Class II bedding material for driveways, sidewalk and sidewalk ramps shall be included in the respective items of work **Grading, Driveway Approach; Grading, Sidewalk;** and **Grading, Sidewalk Ramp;** and shall not be paid for separately.

Detectable warning units shall be paid for in accordance with the Detailed Specification for Detectable Warning Surface.

CITY OF ANN ARBOR
DETAILED SPECIFICATION
FOR
SIDEWALK RETAINING WALLS

AA:DAD

1 of 4

03/22/17

a. Description. This work consists of constructing concrete retaining walls adjacent to sidewalks in accordance with the requirements and special details included herein, and as directed by the Engineer.

b. Materials. Provide concrete Grade P-NC, unless otherwise directed by the Engineer, meeting the requirements of section 602 of the Michigan Department of Transportation (MDOT) 2012 Standard Specifications for Construction.

c. Construction. Construct retaining walls in accordance with special details included herein. Curb face exposure shall be 6 inches to 36 inches.

The Contractor shall excavate, cut, remove stumps, remove brush, remove pavement, grade, and trim as needed and as directed, and shall furnish, place, grade, and compact any materials needed to perform the work.

All subgrade work shall be completed prior to placing concrete items, unless directed or approved by the Engineer.

At locations where the subgrade, subbase or base becomes either disturbed, saturated or otherwise damaged, and where directed by the Engineer, the Contractor shall remove a minimum 6-inch thick layer of the subgrade, subbase or base, and replace it with approved 21AA Aggregate material, compacted in place.

The Contractor shall coordinate with the City Forester prior to the removal of any tree roots 2 inches in diameter or greater.

The Contractor shall maintain on-site at all times, a sufficient quantity of adequate materials to protect concrete items. The Engineer may suspend or defer concrete placement if rain protection is not available. The Contractor shall not be entitled to any additional compensation due to work suspension or deferral resulting from a lack of adequate rain protection.

The Contractor is responsible for any damage to concrete items, including but not limited to vandalism; vehicular, pedestrian and/or miscellaneous structural damage; surface texture damage; and rain damage.

d. Measurement and Payment. The completed work, as described, will be measured and paid for at the contract unit prices for the following pay items:

<u>Pay Item</u>	<u>Pay Unit</u>
Sidewalk Retaining Wall, Integral, 6 inch to 18 inch Height	Square Foot
Sidewalk Retaining Wall, Integral, 18 inch to 30 inch Height	Square Foot

Sidewalk Retaining Wall, Integral, __ inch to __ inch Height shall be measured in place by the exposed face area above the sidewalk in square feet. The unit price for this item of work shall include all labor, materials, and equipment needed to accomplish this work.

All sidewalk work performed adjacent to any retaining wall will be paid for separately.

INTEGRAL SIDEWALK RETAINING WALL (6" - 18") DETAIL

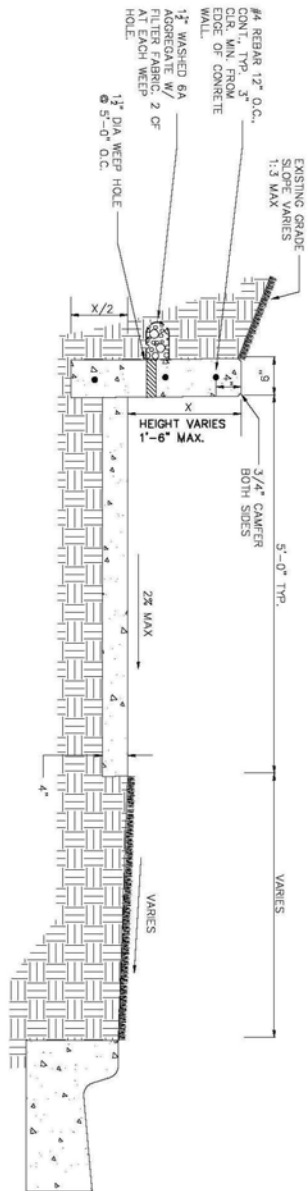

INTEGRAL SIDEWALK RETAINING WALL (18"-36") DETAIL

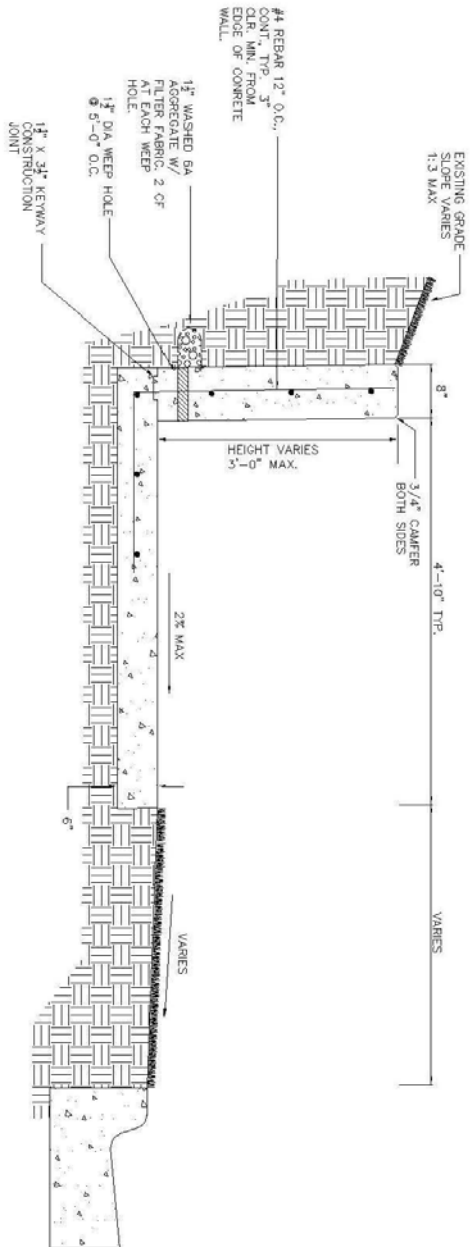

CITY OF ANN ARBOR
DETAILED SPECIFICATION
FOR
DETECTABLE WARNING SURFACE

AA:DAD

1 of 2

04/05/15

a. Description. This work shall consist of furnishing and installing cast in place detectable warning units in compliance to the Americans with Disabilities Act (ADA) Title 49 CFR Transportation, Part 37.9 Standards for Accessible Transportation Facilities, Appendix A, section 4.29.2 Detectable Warnings on Walking Surfaces. All work shall be in accordance with the Special Provision for “Concrete Sidewalk and Sidewalk Ramps”, section 803 of the Michigan Department of Transportation (MDOT) 2012 Standard Specifications for Construction, MDOT Standard Plan Series R-28, as indicated on the plans, and as modified herein.

b. Materials. The detectable warning tiles shall be colored as Federal Number 22144 (frequently referred to as “Colonial Red” or “Brick Red”).

American Society for Testing and Materials (ASTM) Test Methods B117, C1028, D543, D570, D638, D695, D790, D2486, D2565, D5420, and E84 will apply.

The detectable warning tiles shall meet the following material properties, dimensions, and tolerances using the most current test methods:

1. Water Absorption: Not to exceed 0.35% when tested in accordance with ASTM-D570
2. Slip Resistance: 0.80 minimum combined wet/dry static coefficient of friction on top domes and field area, when tested in accordance with ASTM C1028.
3. Compressive Strength: 18,000 psi minimum, when tested in accordance with ASTM D695.
4. Tensile Strength: 10,000 psi minimum, when tested in accordance with ASTM D638.
5. Flexural Strength: 24,000 psi minimum, when tested in accordance with ASTM D790.
6. Chemical Stain Resistance: No reaction to 1% hydrochloric acid, urine, chewing gum, soap solution, motor oil, bleach, calcium chloride, when tested in accordance with ASTM D543 or D1308.
7. Wear Depth: 300 minimum, when tested in accordance with ASTM C501.
8. Flame Spread: 25 maximum, when tested in accordance with ASTM E84.
9. Gardner Impact: 50 in.-lbs. minimum, when tested in accordance with Geometry “GE” of ASTM D5420.
10. Accelerated Weathering of Tile when tested by ASTM-G155 or ASTM G151 shall exhibit the following result- $\Delta E < 6.0$ as well as no deterioration, fading or chalking of surface when exposed to 3000 hours minimum exposure.
11. Wheel Loading: The cast in place tile shall be mounted on a concrete platform with a ½” airspace at the underside of the tile top plate then subjected to the specified maximum load of 10,400 lbs., corresponding to an 8,000 lb individual wheel load and a 30% impact factor. The tile shall exhibit no visible damage at the maximum load of 10,400 lbs using AASHTO-HB17 single sheet HS20-44 loading “Standard Specifications for Highways and Bridges.”
12. Salt and Spray Performance of Tile and Adhesive System when tested to ASTM-B117 not to show any deterioration or other defects after 100 hours of exposure

Submit manufacturer’s literature describing products, installation procedures and maintenance instructions. Provide cast-in-place detectable surface tiles and accessories as produced by a single manufacturer.

Samples for Verification Purposes: Submit two (2) tile samples minimum 6” x 8” of the kind proposed for use. Samples shall be properly labeled and shall contain the following information: Name of Project; Submitted by; Date of Submittal; Manufacture’s Name; Catalog No.; and Date of Fabrication.

Material Test Reports: Submit current test reports from a qualified, independent, testing laboratory indicating that materials proposed for use are in compliance with requirements and meet the properties indicated. The required tests listed elsewhere in this Special Provision shall be performed by a certified and qualified independent testing laboratory on a cast-in-place tactile warning system. All test reports submitted shall be certified by the testing laboratory and shall clearly state that all tests were completed within 5 years of the date of the submittal. The manufacturer shall certify in writing that the materials provided to the project are manufactured with the same materials and manufacturing procedures as those used in the materials on which the test were performed.

c. Construction. Installer’s Qualifications: Engage an experienced Installer who has successfully completed tile installations similar in material, design, and extent to that indicated for this Project.

The contractor shall follow manufacturer specifications for installation, except where they conflict with MDOT Standard Plan Series R-28, or other project requirements.

d. Measurement and Payment. The completed work, as described, will be measured and paid for at the contract unit price for the following pay item:

<u>Pay Item</u>	<u>Pay Unit</u>
Detectable Warning Surface, Modified.....	Foot

The unit price for this item shall include all labor, material, and equipment costs required to complete the work.

CITY OF ANN ARBOR
DETAILED SPECIFICATION
FOR
CAST IRON DETECTABLE WARNING SURFACE

AA:JN

1 of 1

02/04/16

a. Description. This work consists of constructing and/or reconstructing sidewalk ramps with cast iron detectable warning surfaces at the specified location(s). Complete this work according to the standard specifications and Standard Plan R-28 Series, except as modified herein.

b. Materials. Use detectable warning surfaces that provide tactile and visual warning and contrast visually with adjacent walking surfaces, either light-on-dark or dark-on-light. Provide cast iron detectable warning surfaces that conform to the dimensions shown on Standard Plan R-28 Series. Select one of the following products, or provide an approved equal, for this project.

Neenah Foundry

2121 Brooks Ave
Neenah, WI 54956
Phone: 920-725-7000
Product Name: NF Detectable Warning Plates

East Jordan

301 Spring Street
East Jordan, MI 49727
Phone: 800-874-4100
Product Name: EJ Cast Iron Detectable Warning Plate

Provide all detectable warning surfaces from the same manufacturer unless otherwise approved by the Engineer.

c. Construction. Construct sidewalk ramps according to subsection 803.03 of the Standard Specifications for Construction and Standard Plan R-28 Series, except that the ramps must be the thickness as shown on the plans. Install detectable warning surfaces according to the manufacturer's instructions and Standard Plan R-28 Series.

When replacing gutters in addition to sidewalk ramps, transition the gutter cross section in advance of the sidewalk ramp to meet the dimensions and profile in Standard Plan R-28-series.

d. Measurement and Payment. The completed work, as described, will be measured and paid for at the contract unit price using the following pay item:

Pay Item	Pay Unit
Detectable Warning Surface, Cast Iron.....	Square Foot

Detectable Warning Surface, Cast Iron will be measured in place by the area of detectable warning material installed at specified locations. Payment includes all labor, materials, and equipment to install detectable warning surface.

All concrete work required for this work will be measured and paid for as specified elsewhere in this contract.

* MAXIMUM LANDING SLOPE IS 2.0% IN EACH DIRECTION OF TRAVEL. MINIMUM DIMENSIONS 5' x 5'. SEE NOTES.

** MAXIMUM RAMP CROSS SLOPE IS 2.0%, RUNNING SLOPE 5% - 7% (8.3% MAXIMUM). SEE NOTES.

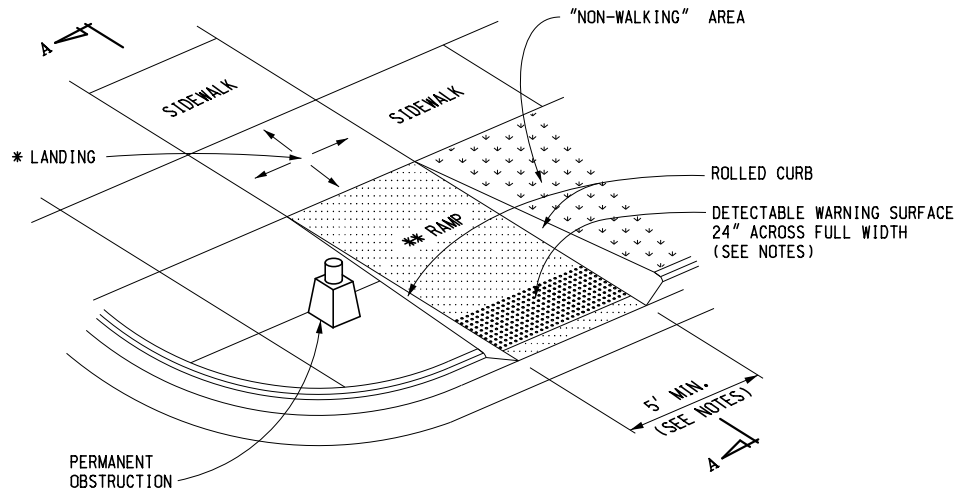

SIDEWALK RAMP TYPE R
(ROLLED SIDES)

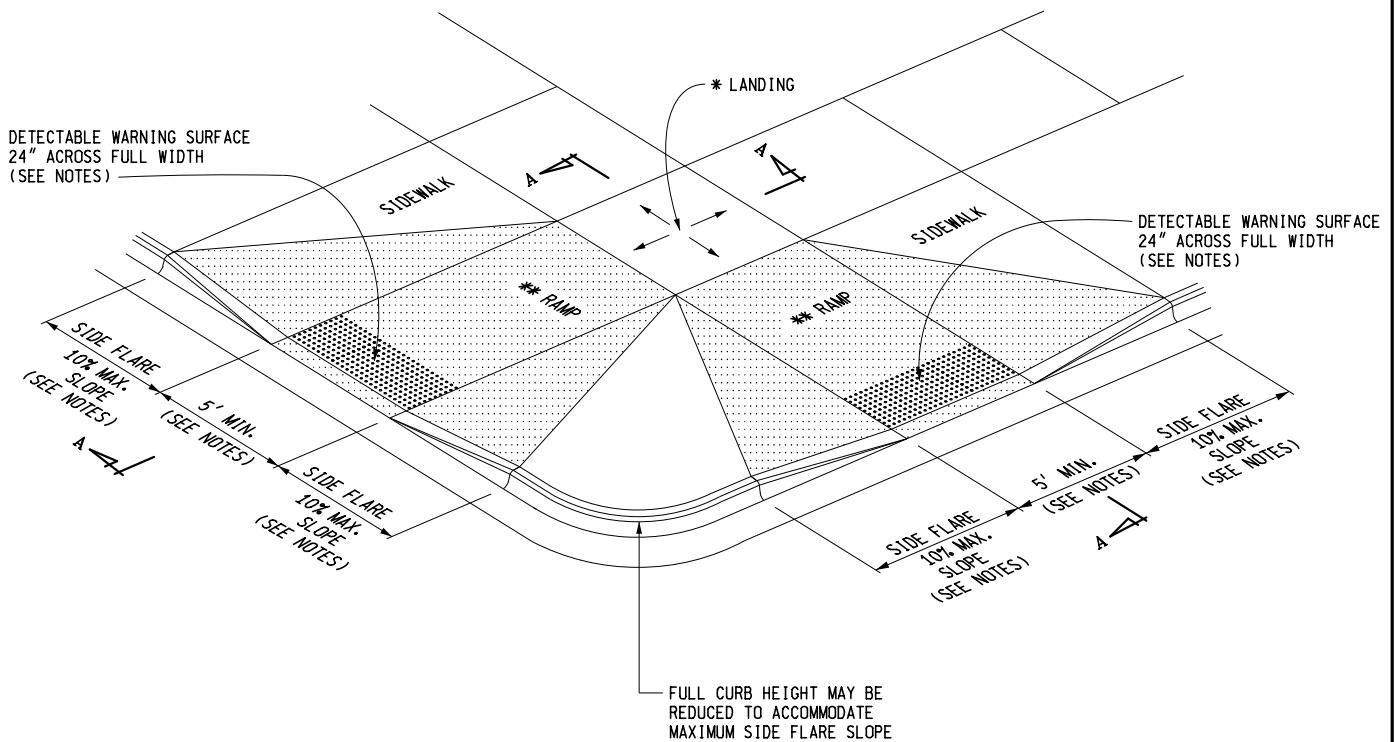

SIDEWALK RAMP TYPE F
(FLARED SIDES, TWO RAMPS SHOWN)



PREPARED BY
DESIGN DIVISION

DRAWN BY: B.L.T.

CHECKED BY: W.K.P.

DEPARTMENT DIRECTOR
Kirk T. Steudle

APPROVED BY: _____
DIRECTOR, BUREAU OF FIELD SERVICES

APPROVED BY: _____
DIRECTOR, BUREAU OF DEVELOPMENT

MICHIGAN DEPARTMENT OF TRANSPORTATION
BUREAU OF DEVELOPMENT STANDARD PLAN FOR

**SIDEWALK RAMP AND
DETECTABLE WARNING DETAILS**

F.H.W.A. APPROVAL

3-15-2016
PLAN DATE

R-28-J

SHEET
1 OF 7

* MAXIMUM LANDING SLOPE IS 2.0% IN EACH DIRECTION OF TRAVEL. MINIMUM DIMENSIONS 5' x 5'. SEE NOTES.

** MAXIMUM RAMP CROSS SLOPE IS 2.0%, RUNNING SLOPE 5% - 7% (8.3% MAXIMUM). SEE NOTES.

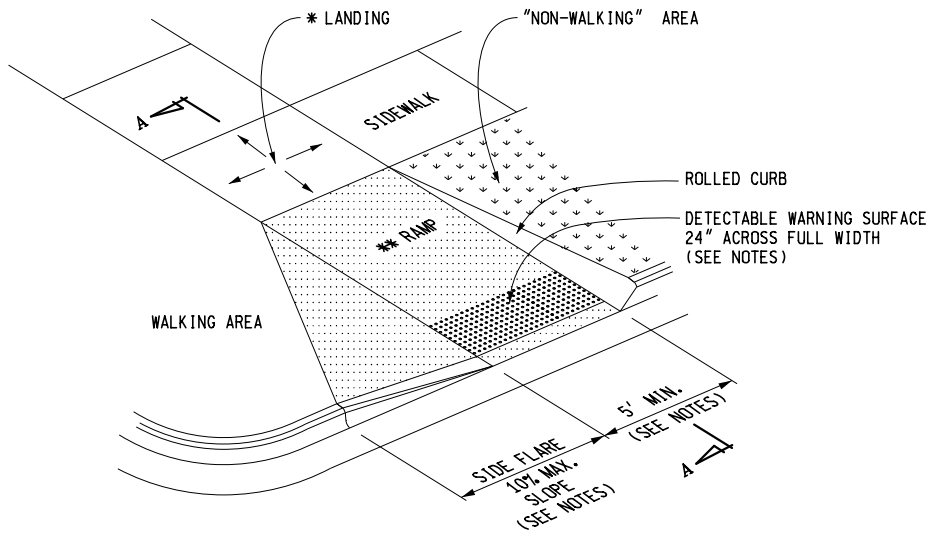

SIDEWALK RAMP TYPE RF
(ROLLED / FLARED SIDES)

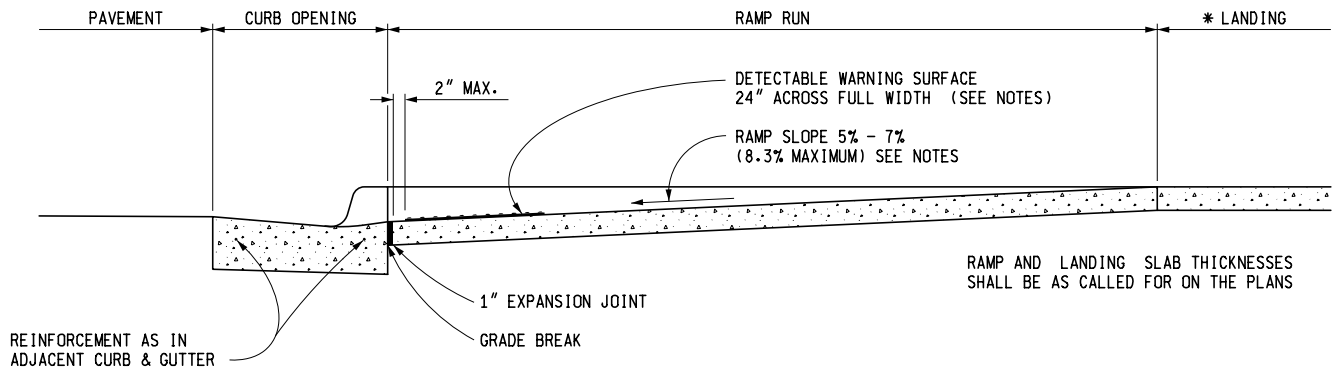

SECTION A-A

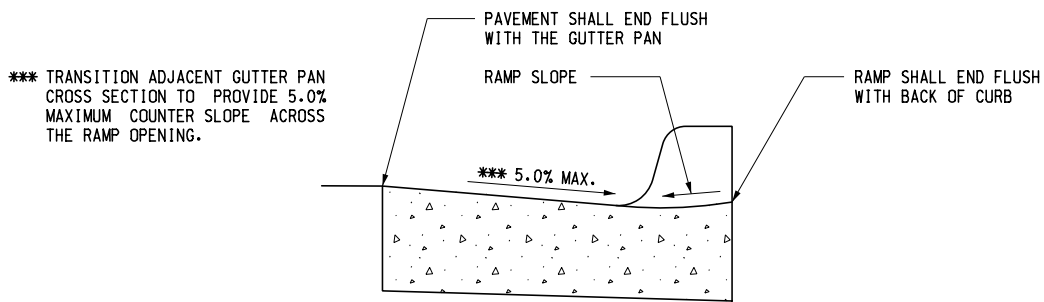

SECTION THROUGH CURB OPENING
(TYPICAL ALL RAMP TYPES)

MICHIGAN DEPARTMENT OF TRANSPORTATION BUREAU OF DEVELOPMENT STANDARD PLAN FOR			
SIDEWALK RAMP AND DETECTABLE WARNING DETAILS			
F.H.W.A. APPROVAL	3-15-2016 PLAN DATE	R-28-J	SHEET 2 OF 7

* MAXIMUM LANDING SLOPE IS 2.0% IN EACH DIRECTION OF TRAVEL. MINIMUM DIMENSIONS 5' x 5'. SEE NOTES.

** MAXIMUM RAMP CROSS SLOPE IS 2.0%, RUNNING SLOPE 5% - 7% (8.3% MAXIMUM). SEE NOTES.

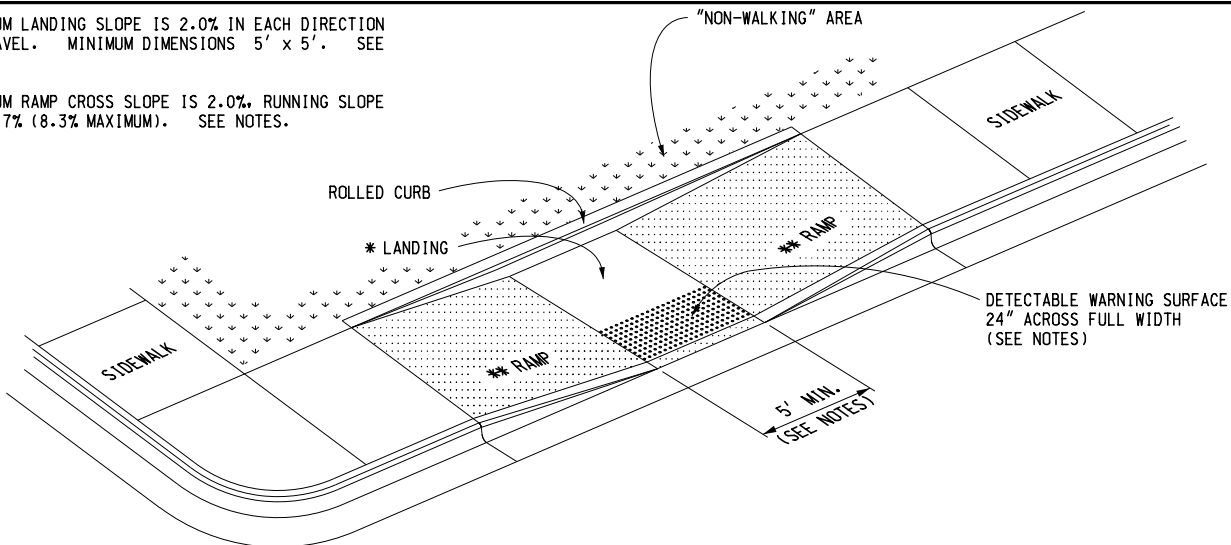

SIDEWALK RAMP TYPE P

(PARALLEL RAMP)

DO NOT USE IN AREAS WHERE PONDING MAY OCCUR

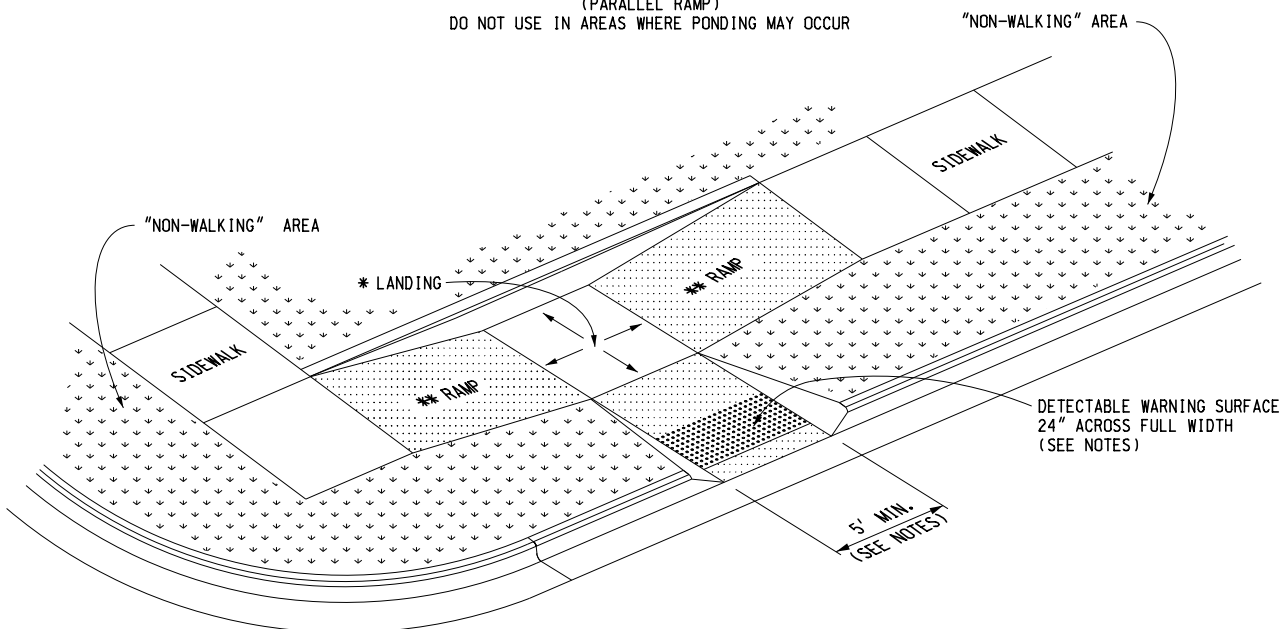

SIDEWALK RAMP TYPE C

(COMBINATION RAMP)

USE 24" DEEP DETECTABLE WARNINGS IF MEDIAN WIDTH IS AT LEAST 6'-0". OTHERWISE NO DETECTABLE WARNING IS REQUIRED.

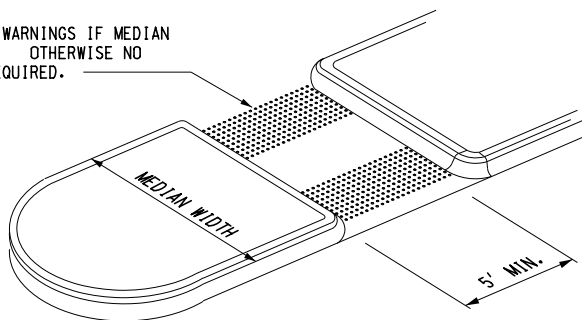

SIDEWALK RAMP TYPE M

(MEDIAN ISLAND)

MICHIGAN DEPARTMENT OF TRANSPORTATION
BUREAU OF DEVELOPMENT STANDARD PLAN FOR

**SIDEWALK RAMP AND
DETECTABLE WARNING DETAILS**

F.H.W.A. APPROVAL

3-15-2016
PLAN DATE

R-28-J

SHEET
3 OF 7

* MAXIMUM LANDING SLOPE IS 2.0% IN EACH DIRECTION OF TRAVEL. MINIMUM DIMENSIONS 5' x 5'. SEE NOTES.

** MAXIMUM RAMP CROSS SLOPE IS 2.0%, RUNNING SLOPE 5% - 7% (8.3% MAXIMUM). SEE NOTES.

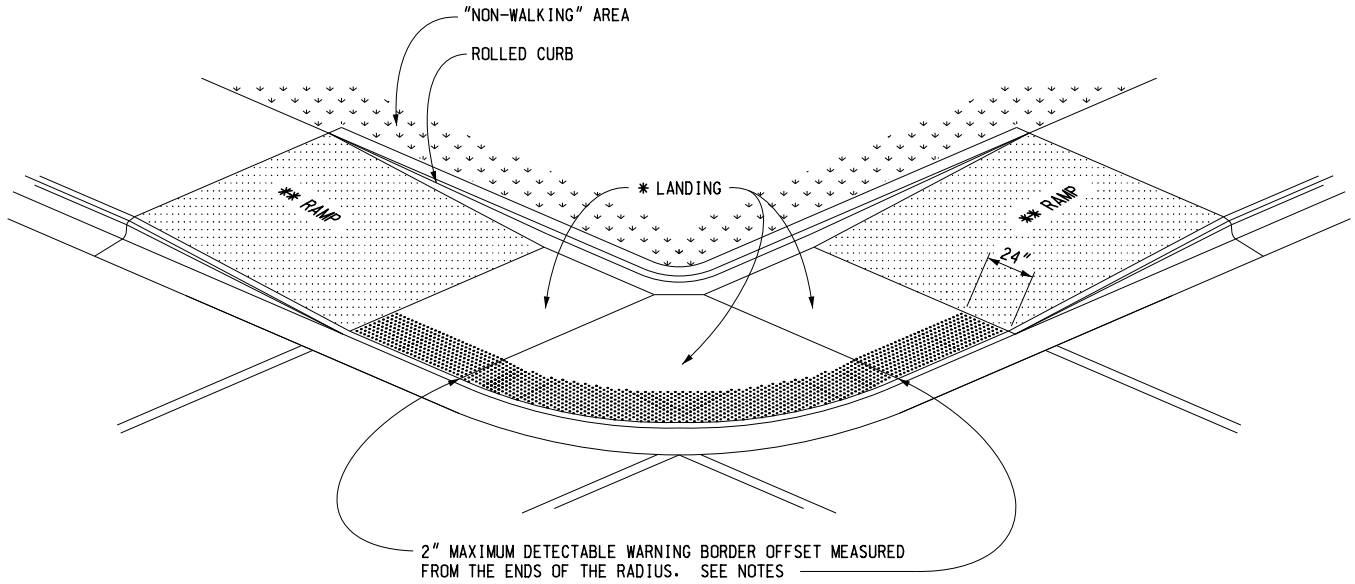

(RADIAL DETECTABLE WARNING SHOWN)

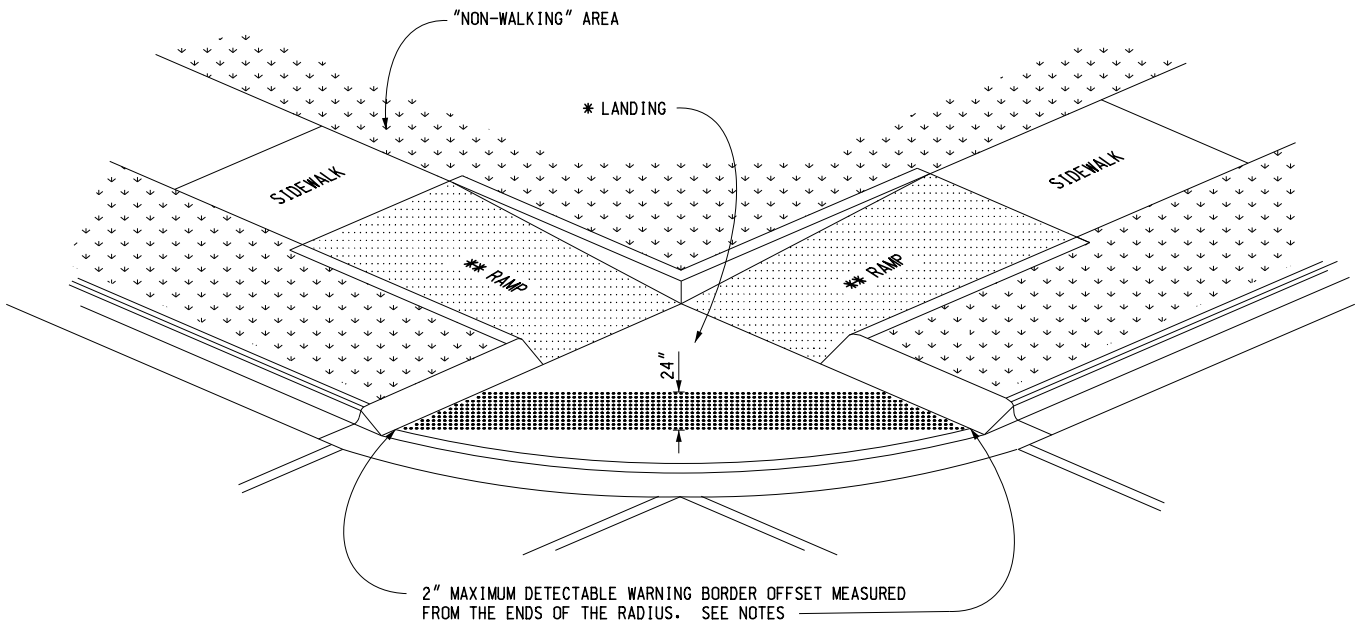

(TANGENT DETECTABLE WARNING SHOWN)

SIDEWALK RAMP TYPE D

(DEPRESSED CORNER)

USE ONLY WHEN INDEPENDENT DIRECTIONAL RAMPS CAN NOT BE CONSTRUCTED FOR EACH CROSSING DIRECTION

MICHIGAN DEPARTMENT OF TRANSPORTATION
 BUREAU OF DEVELOPMENT STANDARD PLAN FOR

**SIDEWALK RAMP AND
 DETECTABLE WARNING DETAILS**

F.H.W.A. APPROVAL	3-15-2016 PLAN DATE	R-28-J	SHEET 4 OF 7
-------------------	------------------------	--------	-----------------

* THE DETECTABLE WARNING SURFACE SHALL BE LOCATED SO THAT THE EDGE NEAREST THE RAIL CROSSING IS 6' MINIMUM AND 15' MAXIMUM FROM THE CENTERLINE OF THE NEAREST RAIL. DO NOT PLACE DETECTABLE WARNING ON RAILROAD CROSSING MATERIAL.

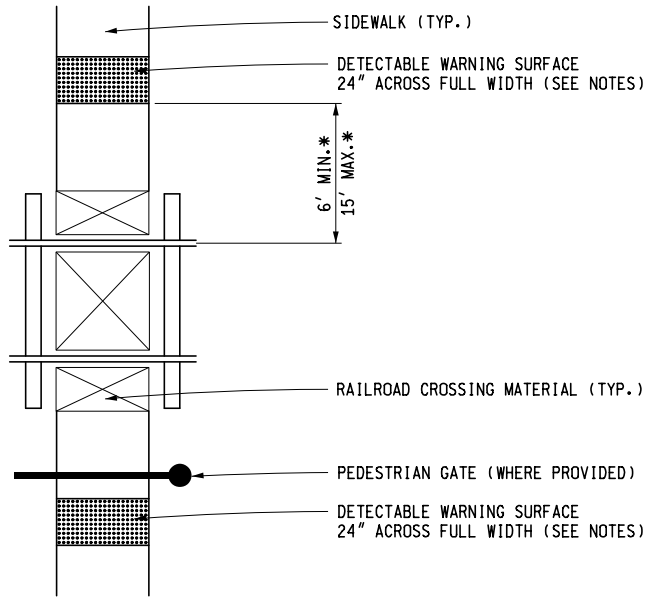

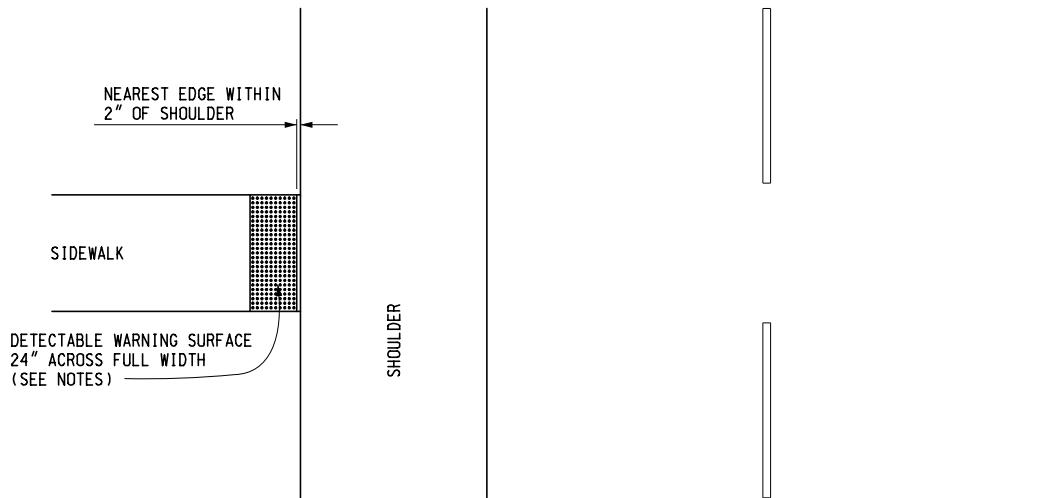

DETECTABLE WARNING AT RAILROAD CROSSING



DETECTABLE WARNING AT FLUSH SHOULDER OR ROADWAY

MICHIGAN DEPARTMENT OF TRANSPORTATION BUREAU OF DEVELOPMENT STANDARD PLAN FOR		
SIDEWALK RAMP AND DETECTABLE WARNING DETAILS		
F.H.W.A. APPROVAL	3-15-2016 PLAN DATE	R-28-J
		SHEET 5 OF 7

LEGEND

	SLOPED SURFACE
	DETECTABLE WARNING
	"NON-WALKING" AREA
	CROSSWALK MARKING
	PREFERRED LOCATION OF DRAINAGE INLET (TYP.)
	ALTERNATE LOCATION OF DRAINAGE INLET (TYP.)

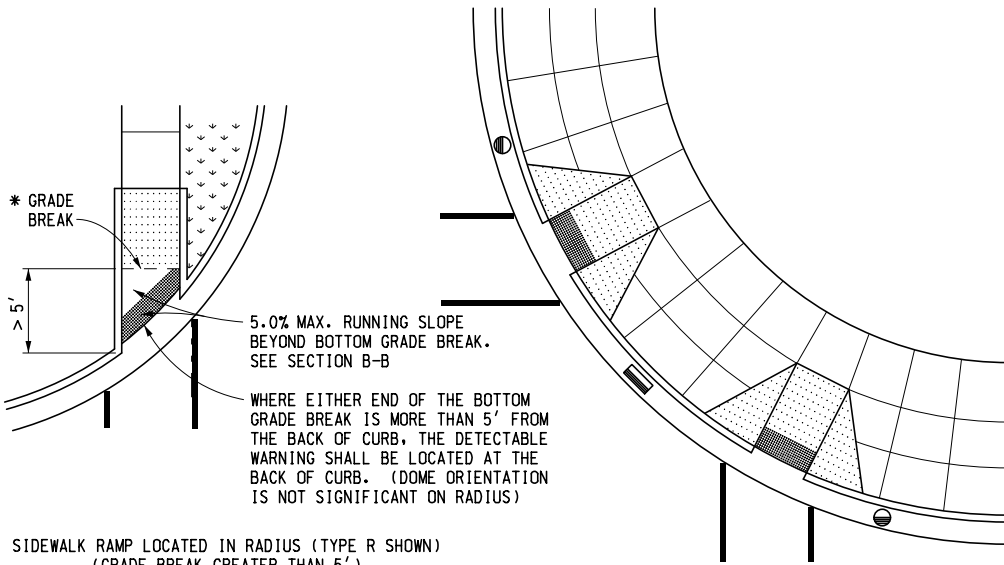

SIDEWALK RAMP LOCATED IN RADIUS (TYPE R SHOWN)
(GRADE BREAK GREATER THAN 5')

SIDEWALK RAMP PERPENDICULAR TO RADIAL CURB (TYPE F SHOWN)
(USE WITH RADIAL CURB WHEN THE CROSSWALK AND SIDEWALK RAMP ARE NOT ALIGNED)

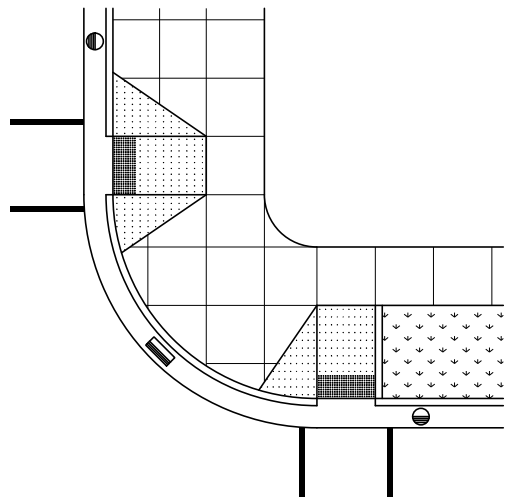

SIDEWALK RAMP PERPENDICULAR TO TANGENT CURB
(TYPE F AND TYPE RF SHOWN)

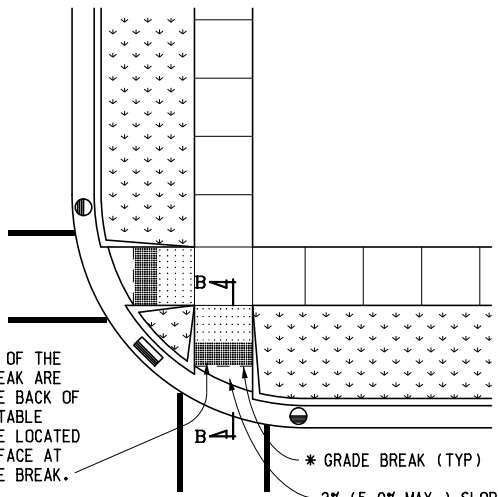

WHERE BOTH ENDS OF THE BOTTOM GRADE BREAK ARE WITHIN 5' OF THE BACK OF CURB, THE DETECTABLE WARNING SHALL BE LOCATED ON THE RAMP SURFACE AT THE BOTTOM GRADE BREAK.

* GRADE BREAK (TYP.)
2% (5.0% MAX.) SLOPE BEYOND BOTTOM GRADE BREAK

SIDEWALK RAMP LOCATED IN RADIUS (TYPE R SHOWN)
(GRADE BREAK LESS THAN 5')

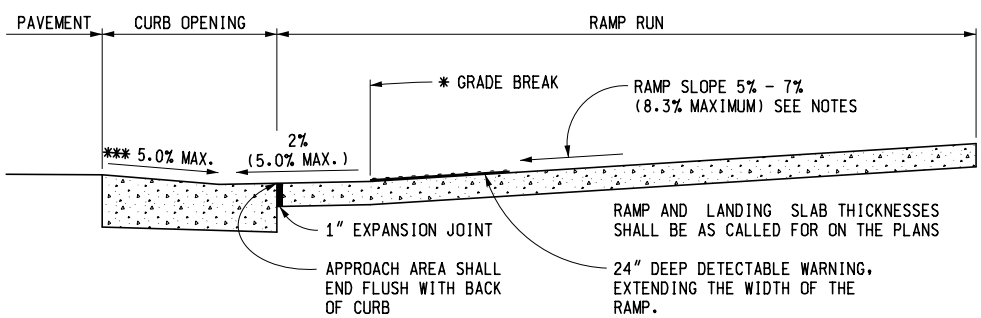

* GRADE BREAKS AT THE TOP AND BOTTOM OF CURB RAMPS SHALL BE PERPENDICULAR TO THE DIRECTION OF TRAVEL.

*** TRANSITION ADJACENT GUTTER PAN CROSS SECTION TO PROVIDE 5.0% MAXIMUM COUNTER SLOPE ACROSS THE RAMP OPENING.

SECTION B-B

SIDEWALK RAMP ORIENTATION

MICHIGAN DEPARTMENT OF TRANSPORTATION
BUREAU OF DEVELOPMENT STANDARD PLAN FOR

**SIDEWALK RAMP AND
DETECTABLE WARNING DETAILS**

F.H.W.A. APPROVAL	3-15-2016 PLAN DATE	R-28-J	SHEET 6 OF 7
-------------------	------------------------	--------	-----------------

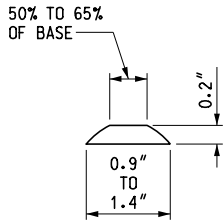

DOME SECTION

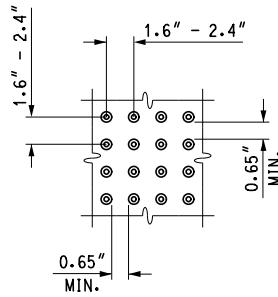

DOME SPACING

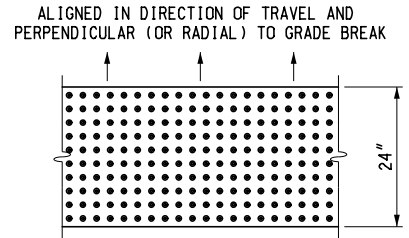

DOME ALIGNMENT

DETECTABLE WARNING DETAILS

NOTES:

DETAILS SPECIFIED ON THIS PLAN APPLY TO ALL CONSTRUCTION, RECONSTRUCTION, OR ALTERATION OF STREETS, CURBS, OR SIDEWALKS IN THE PUBLIC RIGHT OF WAY.

SIDEWALK RAMPS ARE TO BE LOCATED AS SPECIFIED ON THE PLANS OR AS DIRECTED BY THE ENGINEER.

RAMPS SHALL BE PROVIDED AT ALL CORNERS OF AN INTERSECTION WHERE THERE IS EXISTING OR PROPOSED SIDEWALK AND CURB. RAMPS SHALL ALSO BE PROVIDED AT MARKED AND/OR SIGNALIZED MID-BLOCK CROSSINGS.

SURFACE TEXTURE OF THE RAMP SHALL BE THAT OBTAINED BY A COARSE BROOMING, TRANSVERSE TO THE RUNNING SLOPE.

SIDEWALK SHALL BE RAMPED WHERE THE DRIVEWAY CURB IS EXTENDED ACROSS THE WALK.

CARE SHALL BE TAKEN TO ASSURE A UNIFORM GRADE ON THE RAMP. WHERE CONDITIONS PERMIT, IT IS DESIRABLE THAT THE SLOPE OF THE RAMP BE IN ONLY ONE DIRECTION, PARALLEL TO THE DIRECTION OF TRAVEL.

RAMP WIDTH SHALL BE INCREASED, IF NECESSARY, TO ACCOMMODATE SIDEWALK SNOW REMOVAL EQUIPMENT NORMALLY USED BY THE MUNICIPALITY.

WHEN 5' MINIMUM WIDTHS ARE NOT FEASIBLE, RAMP WIDTH MAY BE REDUCED TO NOT LESS THAN 4' AND LANDINGS TO NOT LESS THAN 4' x 4'.

DETECTABLE WARNING SURFACE COVERAGE IS 24" MINIMUM IN THE DIRECTION OF RAMP/PATH TRAVEL AND THE FULL WIDTH OF THE RAMP/PATH OPENING EXCLUDING CURBED OR FLARED CURB TRANSITION AREAS. A BORDER OFFSET NOT GREATER THAN 2" MEASURED ALONG THE EDGES OF THE DETECTABLE WARNING IS ALLOWABLE. FOR RADIAL CURB THE OFFSET IS MEASURED FROM THE ENDS OF THE RADIUS.

FOR NEW ROADWAY CONSTRUCTION, THE RAMP CROSS SLOPE MAY NOT EXCEED 2.0%. FOR ALTERATIONS TO EXISTING ROADWAYS, THE CROSS SLOPE MAY BE TRANSITIONED TO MEET AN EXISTING ROADWAY GRADE. THE CROSS SLOPE TRANSITION SHALL BE APPLIED UNIFORMLY OVER THE FULL LENGTH OF THE RAMP.

THE MAXIMUM RUNNING SLOPE OF 8.3% IS RELATIVE TO A FLAT (0%) REFERENCE. HOWEVER, IT SHALL NOT REQUIRE ANY RAMP OR SERIES OF RAMPS TO EXCEED 15 FEET IN LENGTH.

DRAINAGE STRUCTURES SHOULD NOT BE PLACED IN LINE WITH RAMPS. THE LOCATION OF THE RAMP SHOULD TAKE PRECEDENCE OVER THE LOCATION OF THE DRAINAGE STRUCTURE. WHERE EXISTING DRAINAGE STRUCTURES ARE LOCATED IN THE RAMP PATH OF TRAVEL, USE A MANUFACTURER'S ADA COMPLIANT GRATE. OPENINGS SHALL NOT BE GREATER THAN 1/2". ELONGATED OPENINGS SHALL BE PLACED SO THAT THE LONG DIMENSION IS PERPENDICULAR TO THE DOMINANT DIRECTION OF TRAVEL.

TRANSITION THE GUTTER PAN CROSS SECTION SUCH THAT THE COUNTER SLOPE IN THE DIRECTION OF RAMP TRAVEL IS NOT GREATER THAN 5.0%. MAINTAIN THE NORMAL GUTTER PAN CROSS SECTION ACROSS DRAINAGE STRUCTURES.

THE TOP OF THE JOINT FILLER FOR ALL RAMP TYPES SHALL BE FLUSH WITH THE ADJACENT CONCRETE.

CROSSWALK AND STOP LINE MARKINGS, IF USED, SHALL BE SO LOCATED AS TO STOP TRAFFIC SHORT OF RAMP CROSSINGS. SPECIFIC DETAILS FOR MARKING APPLICATIONS ARE GIVEN IN THE "MICHIGAN MANUAL OF UNIFORM TRAFFIC CONTROL DEVICES".

FLARED SIDES WITH A SLOPE OF 10% MAXIMUM, MEASURED ALONG THE ROADSIDE CURB LINE, SHALL BE PROVIDED WHERE AN UNOBSTRUCTED CIRCULATION PATH LATERALLY CROSSES THE SIDEWALK RAMP. FLARED SIDES ARE NOT REQUIRED WHERE THE RAMP IS BORDERED BY LANDSCAPING, UNPAVED SURFACE OR PERMANENT FIXED OBJECTS. WHERE THEY ARE NOT REQUIRED, FLARED SIDES CAN BE CONSIDERED IN ORDER TO AVOID SHARP CURB RETURNS AT RAMP OPENINGS.

DETECTABLE WARNING PLATES MUST BE INSTALLED USING FABRICATED OR FIELD CUT UNITS CAST AND/OR ANCHORED IN THE PAVEMENT TO RESIST SHIFTING OR HEAVING.

MICHIGAN DEPARTMENT OF TRANSPORTATION
BUREAU OF DEVELOPMENT STANDARD PLAN FOR

**SIDEWALK RAMP AND
DETECTABLE WARNING DETAILS**

F.H.W.A. APPROVAL	3-15-2016 PLAN DATE	R-28-J	SHEET 7 OF 7
-------------------	------------------------	--------	-----------------

CITY OF ANN ARBOR
DETAILED SPECIFICATION
FOR
REMOVAL AND REINSTALLATION OF CONCRETE OR CLAY BRICK PAVERS

AA:DAD

1 of 2

03/04/17

a. Description. This work consists of removing, stockpiling and reinstalling concrete, clay, or other type material, brick sidewalk pavers. Furnish and install sand base, concrete base, fine aggregate leveling bed, fine aggregate joint filler, and any additional brick pavers as shown on the plans, and as directed by the Engineer.

b. Materials.

Aggregate base, where required, shall consist of Dense-Graded Class 21AA Limestone in accordance with section 902 of the Michigan Department of Transportation 2012 Standard Specifications for Construction.

Sand base, where required, shall consist of Granular Material Class II in accordance with section 902 of the MDOT 2012 Standard Specifications for Construction.

Construct concrete base, where required, using Grade P1 or Grade P2 concrete in accordance with section 601 of the MDOT 2012 Standard Specifications for Construction.

Fine aggregate leveling bed shall consist of a 3:1 mix of Fine Aggregate 2NS (3 parts) and Type N Masonry Cement (1 part). Use Fine Aggregate 2MS as joint filler. Masonry cement and fine aggregate materials shall be in accordance with sections 901 and 902, respectively, of the MDOT 2012 Standard Specifications for Construction.

Any additional brick pavers required shall match the material and color of the existing brick pavers in the areas adjoining the removal/replacement limits.

c. Construction. The Contractor shall remove and salvage existing pavers, remove any existing mortar or bituminous setting bed and concrete base, to the limits specified by the Engineer, down to the existing aggregate base. Where an existing base is not present, the subbase shall be removed to a sufficient depth for construction of the proposed section as shown on the attached detail, or as directed by the Engineer. Salvaged pavers shall be stored on-site in an area approved by the Engineer until they are ready for use.

The Contractor shall shape, grade, and compact the existing base materials, and shall construct the base to match the existing adjacent elevations.

Blend fine aggregate and mortar uniformly to create the leveling bed mix. Place leveling bed on aggregate base or existing concrete base to the depth shown on the Plans. Use control bars and/or guides to screed the fine aggregate leveling bed.

Brick installation is to match the pattern of the existing adjacent brickwork. Use string lines or other devices as needed to insure straight joint lines and final surface elevations. Butt paving units tight to adjacent concrete paving and to each other. Protect newly laid pavers at all times by plywood panels on which workers stand. Use a plate vibratory compactor (min. 5,000 lbs compaction force) and make a minimum of three (3) passes to set paving units in leveling course prior to filling joints. Protect pavers from chipping and cracking during compaction.

Spread fine aggregate joint filler over paver surface and broom into joints, and mist lightly with water

to settle sand into joints. Allow to surface dry and repeat process, as required, to fill joints completely. Remove excess sand upon completion.

The Contractor shall take any necessary precautions to prevent damage to pavers during removal and replacement. The Contractor is not entitled to any additional compensation for such replacement of damaged pavers.

d. Measurement and Payment. The completed work, as described, will be measured and paid for at the contract unit prices for the following pay items:

Pay Item

Pay Unit

Sidewalk, Conc or Clay Brick Pavers, Rem and Reinstall..... Square Foot

The unit price for this item of work shall include all labor, material, and equipment costs to perform all the work specified by this Detailed Specification.

CITY OF ANN ARBOR
DETAILED SPECIFICATION
FOR
FENCE, PROTECTIVE, MODIFIED

AA:DAD

1 of 2

04/05/15

a. Description. This work shall consist of taking all reasonable measures to protect all existing trees and vegetation designated to remain and be protected within the project limits and the construction influence area, in accordance with subsection 201.03.A.2 and section 808 of the Michigan Department of Transportation (MDOT) 2012 Standard Specifications for Construction, except as specified herein. The work shall also consist of installing protective fencing at the limits of the construction area as shown on the plans or in areas directed by the Engineer.

b. Materials. Fabric shall be orange, vinyl, snow fence material, 4 feet tall. Posts shall be 6 foot long, T-shaped, metal posts or 2 inch square hardwood stakes.

c. Construction. Install protective fence at the limits of the construction area as shown on the plans or as directed by the Engineer.

The Contractor shall not operate equipment within the tree protection fence of any existing tree without the approval of the Engineer.

Construction material, supplies, or equipment shall not be stockpiled or stored within the limits of the tree protection fence.

Vehicles and personnel are not permitted within the limits of the tree protection fence.

The Contractor shall not attach chains, cables, ropes, nails, or other articles to any tree at any time.

Tree roots 1-1/2 inch or greater in diameter exposed during construction must be pruned. All pruning operations shall be reviewed and approved by the Engineer. All root pruning shall be performed with sharp tools and shall provide clean cuts that do not unnecessarily damage the remaining bark or root. The Contractor shall not perform any backfilling operations until all root maintenance has been performed.

Any damage to trees owned by the City of Ann Arbor or other trees designated to be protected due to the Contractor's activities or activities of the Contractor's subcontractors or suppliers shall be repaired under the direction of the City Forester by an approved forestry specialist. The costs of these repairs shall be the sole responsibility of the Contractor.

Should the Contractor's operations damage a plant's roots to the extent that it must be removed, the Contractor shall either replace the plant with a commensurate number of plants, 2½" caliper trees of the species as determined by the City, or compensate the City of Ann Arbor for the cash value of the plant or tree as determined by the City of Ann Arbor's Forester. The City of Ann Arbor shall be solely responsible for determining which compensation method is used.

The City Forester shall supervise the replacement of any trees at the sole expense of the Contractor.

Remove tree protection fence when directed by the Engineer.

d. Measurement and Payment. The completed work, as described, will be measured and paid for at the contract unit price for the following pay item:

<u>Pay Item</u>	<u>Pay Unit</u>
Fence, Protective, Modified	Foot

Fence, Protective, Modified will be measured in length, by feet of protective fence used, and will be paid for at the contract unit price which shall be payment in full for all labor, materials, and equipment needed to accomplish this work. No additional payment will be made for maintenance or reinstallation of fence during the construction period. No additional payment will be made for repair or replacement of vegetation as noted above.

CITY OF ANN ARBOR
 DETAILED SPECIFICATION
 FOR
WET REFLECTIVE LIQUID APPLIED PAVEMENT MARKINGS

AA:DAD

1 of 2

03/28/16

a. Description. This work consists of furnishing and installing wet night retroreflective (WR) beads and/or elements and liquid applied pavement marking materials.

b. Materials.

1. Wet Night Retroreflective Beads and/or Elements. Select WR beads and/or elements from one of the following Manufacturers or a Department approved alternative that meets the requirements in Table 1:

- 3M Corporation
- Potter's Industries
- Swarco
- Flex-o-Lite

Table 1: WR Markings

Average Initial Retroreflectivity at 30 meter geometry in mcd/lux/m ²		
Test Method	Color	
	White	Yellow
Dry (ASTM E 1710)	700	500
Wet Recovery (ASTM E 2177)	250	200

Ship the material to the job site in sturdy containers marked in accordance with subsection 920.01.A of the Standard Specifications for Construction.

Submit to the Engineer prior to the start of work:

A. The Manufacturer's recommended application rate of the beads/elements and the liquid applied pavement marking binder to be used on the project. If the Manufacturer's recommended application rate differs from the specified rate in Table 811-1 of the Standard Specifications for Construction, the Manufacturer's recommended rate supersedes the table values.

B. Certification from the Manufacturer that when applied according to their application recommendations the beads and/or elements meet the requirements shown in Table 1 above.

2. Binder. Provide a liquid pavement marking product of the binder type specified in the contract documents from section 811 of the Qualified Products List or as specified by special provision, or use an alternative binder as approved by the Engineer.

c. Construction. Place the binder and beads in accordance with the Manufacturers' recommendations and sections 811 and 920 of the Standard Specifications for Construction except as noted above.

d. Measurement and Payment. The completed work, as described, will be measured and paid for at contract unit prices using the following pay items:

Pay Item	Pay Unit
Pavt Mrkg, Wet Retrflec Polyurea, 12 inch, Crosswalk	Foot
Pavt Mrkg, Wet Retrflec Polyurea, 24 inch, Stop Bar	Foot
Pavt Mrkg, Wet Retrflec Polyurea, 4 inch, Parking Sym, White	Foot
Pavt Mrkg, Wet Retrflec Polyurea, Lt Turn Arrow Sym	Each
Pavt Mrkg, Wet Retrflec Polyurea, Rt Turn Arrow Sym	Each
Pavt Mrkg, Wet Retrflec Polyurea, Only	Each
Pavt Mrkg, Wet Retrflec Thermopl, 6 inch, Crosswalk	Foot
Pavt Mrkg, Wet Retrflec Thermopl, 12 inch, Crosswalk	Foot
Pavt Mrkg, Wet Retrflec Thermopl, 12 inch, Cross Hatching, White	Foot
Pavt Mrkg, Wet Retrflec Thermopl, 12 inch, Cross Hatching, Yellow	Foot
Pavt Mrkg, Wet Retrflec Thermopl, 24 inch, Stop Bar	Foot
Pavt Mrkg, Wet Retrflec Thermopl, 4 inch, Parking Sym, White	Foot
Pavt Mrkg, Wet Retrflec Thermopl, Lt Turn Arrow Sym	Each
Pavt Mrkg, Wet Retrflec Thermopl, Rt Turn Arrow Sym	Each
Pavt Mrkg, Wet Retrflec Thermopl, Thru and Lt Turn Arrow Sym	Each
Pavt Mrkg, Wet Retrflec Thermopl, Thru and Rt Turn Arrow Sym	Each
Pavt Mrkg, Wet Retrflec Thermopl, Only	Each
Pavt Mrkg, Wet Retrflec Thermopl, Railroad Sym	Each
Pavt Mrkg, Wet Retrflec Thermopl, School	Each
Pavt Mrkg, Wet Retrflec Thermopl, Speed Hump Chevron, White	Each

The unit price for these items of work shall include all labor, material, and equipment costs to perform all the work.

CITY OF ANN ARBOR
DETAILED SPECIFICATION
FOR
MAINTENANCE OF TRAFFIC

AA:DAD

1 of 5

03/28/16

a. Description. Traffic shall be maintained by the Contractor at the locations identified on the "Schedule of Streets" for duration of the work in accordance with the plans, subsection 104.11 and section 812 of the Michigan Department of Transportation (MDOT) 2012 Standard Specifications for Construction, the Michigan Manual of Uniform Traffic Control Devices (MMUTCD), applicable supplemental specifications, as directed by the Engineer, and as herein specified.

The following, and herein included, Michigan Department of Transportation (MDOT) Maintaining Traffic Typical and Work Zone Device Details apply to the project: M0020a, M0040a, M0110a, M0140a, M0240a WZD-100-A, and WZD-125-E.

These maintaining traffic provisions are subject to change in the event of special community activities.

The permanent pavement marking items are included in the contract and shall be placed per the MDOT 2012 Standard Specifications for Construction prior to the removal of any devices required to temporarily maintain traffic during construction, and also prior to opening the project to traffic.

b. Materials. Materials for all devices used to temporarily control and maintain traffic shall meet the requirements of section 812 of the MDOT 2012 Standard Specifications for Construction, the MMUTCD, and the applicable MDOT typicals and details included herein.

All signs shall be of sizes shown on the plans, unless otherwise directed by the Engineer. Temporary signs, which are to remain in the same place for 14 days or more, shall be installed on driven posts. All other temporary signs may be installed on portable supports. All signs shall have a minimum bottom height of 7.0 feet.

Channelizing devices required for all lane closures shall be plastic drums. 42 inch channelizing devices are permissible at certain locations with approval from the Engineer.

c. Construction. Construction methods shall meet the requirements of section 812 of the MDOT 2012 Standard Specifications for Construction.

The Contractor shall furnish and place all necessary temporary traffic control devices to maintain traffic during construction. All work, construction equipment, and material storage shall be kept behind the curb, or behind barricades or channelizing devices, all in combination with protective fencing, if required to protect open excavations, and shall not in any way hamper vehicle movement or impair traffic vision. The contractor shall also provide protection to all uncured concrete sidewalk, driveways, and curb and gutter as may be needed until all traffic, either foot or otherwise, can cross without damage. Additional barricades and protective fencing shall be installed at the end of each day to insure no disturbance to the work area.

Distances between warning, regulatory, and guide signs as shown on the typicals and details are approximate, and may require field adjustment, as directed by the Engineer.

The Contractor shall maintain two-way traffic as shown on the plans, access for local traffic on local streets, and keep all intersections open to traffic at all times, unless specifically authorized in writing by the Engineer.

The Contractor shall maintain traffic such that no vehicle shall be required to drive into active work areas. Patch areas which extend more than halfway across the roadway shall be removed and replaced so as to provide a minimum of half the pavement width at all times for maintaining traffic.

The Contractor shall remove existing pavement markings and place temporary pavement markings as directed by the Engineer.

All temporary traffic/pedestrian control devices furnished by the Contractor shall remain the property of the Contractor. The City shall not be responsible for stolen or damaged signs, barricades, plastic drums and other traffic maintenance items. The Contractor shall replace missing and/or damaged traffic control devices immediately, at no additional cost to the City.

1. Construction Influence Area (CIA). The CIA shall consist of, at each location, the width of the right-of-way and easements, and the limits of any advance temporary construction signing shown on the plans and applicable maintaining traffic typicals along the street under construction and any/all cross streets. Posted detour routes are not considered part of the CIA.

The Contractor shall furnish, erect, maintain, and upon completion of the work, remove all traffic control devices within and around the CIA, and along posted detour routes, for the safety and protection of traffic. This includes, but is not limited to, regulatory and warning signs, barricades, channeling devices and other minor devices where required by the Engineer.

The Contractor shall coordinate its operations with all subcontractors, utilities, and/or other contractors performing work on this and other projects within, or adjacent to, the Construction Influence Area (CIA). The contractor shall avoid conflicts in maintaining traffic operations, signing, and orderly progress of other contract work.

2. Permits. Prior to the start of construction, the Contractor shall obtain a "Right-of-Way" Permit from City of Ann Arbor Customer Services Unit. The Contractor shall notify the Project Engineer and obtain a "Traffic Detour or Lane Closure" Permit from City of Ann Arbor Project Management Services Unit a minimum of 72 business hours prior to the implementation of any traffic shifts, lane closures and street closures. The fees for these permits will be waived.

3. Work Times and Restrictions. All work shall be conducted Monday through Saturday between 7:00am and 8:00pm; unless an alternate plan identifying the days and hours of work has been authorized by the City prior to commencement of construction. Should night work be required for any reason, the Project Engineer must be notified three (3) working days (72 hours) in advance of such work, and the work must have the approval of the City prior to commencement.

Only work of an emergency nature or work required to insure traffic safety shall be performed on Sunday and only with prior approval by the City.

No road work shall be performed nor traffic interruptions be permitted, including lane closures, on Sundays, and during the Memorial Day, July 4th, and Labor Day holiday periods unless otherwise authorized by the Engineer. All streets and sidewalks that can be opened shall be opened. Trucking on or off site will not be permitted.

During non-working periods, any area with uncompleted work shall have plastic drums at specific locations and protective fencing, as directed by the Engineer, and at no additional cost to the project.

4. Traffic Restrictions. The Contractor shall, at all times, conduct its work to insure the least possible obstruction to traffic and inconvenience to the general public, businesses, and residents in the vicinity of the work.

Traffic on major streets should not be impacted between the hours of 7:00 a.m. to 9:00 a.m. and from 3:30 p.m. to 6:00 p.m. unless otherwise approved by the Engineer or as specified on the Lane Closure Permit. All major changes in traffic control shall be made either between 9:00 a.m. and 3:30 p.m. or between 7:00 p.m. and 6:30 a.m. in order to minimize interference with rush hour traffic. All traffic controls must be in place and ready for traffic each day by 6:30 a.m. and 3:30 p.m. Temporary obstruction of traffic for loading and unloading of trucks will be permitted if the Contractor provides traffic regulators (flag persons) in conformance with Part VI of the MMUTCD. During temporary obstructions, a minimum of two traffic regulators are required. The cost of traffic regulators (flag control) shall be included in the contract pay item "Minor Traffic Control, Modified, Max \$____".

Access to businesses, residences, and side street(s) within the CIA shall be maintained for the duration of the project. The Contractor shall make every effort to coordinate its operations to minimize interruptions impacting this access. The Contractor shall notify the Project Engineer forty-eight (48) hours in advance of any work to be performed on or near business or residential driveways, and stage work so that it is part-width when it is necessary to work in these areas. Prohibiting access to businesses and residences will not be allowed during any phase of construction, and flagging will be required at the discretion of the Engineer.

A minimum of one lane of traffic in each direction must be maintained on Pauline Blvd at all times by use of signage and other traffic control devices unless other authorized by the Engineer.

Lane width shall be a minimum of 9 feet wide. Contractor shall schedule work so that under no circumstances traffic is stopped. The work within the CIA shall be suspended, during peak traffic hours and/or when traffic is being unduly hampered or delayed by all construction activity, at the discretion of the Engineer.

5. Emergency Services. The Contractor shall notify local police, fire departments and emergency response units a minimum of three business days (72 hours) prior to the closure of any lanes, or traffic shifts causing restricted movements of traffic or restricted access. Fire hydrants in or adjacent to the work shall be kept "live" and fire fighting forces made aware of their availability at all times during construction.

6. Project Phasing (S Division St). The Contractor shall notify the Engineer a minimum of 72 hours prior to the implementation of lane or road closures. See Maintenance of Traffic plans for details and limits of construction.

- A. **Stage 1 Phase 1** The work zone is limited to the east half of South Division Street from the POB to the north quadrant of East William Street. The Jefferson Street will be closed upon commencement of bumpout construction.

Jefferson Street may remain closed for the duration of the project unless directed other by the Engineer.

- B. **Stage 1 Phase 2A & 2B** The work zone is extended to include the east half of South Division Street to East Huron Street. Implement lane restrictions and detours on East Williams, Liberty, and East Washington. Traffic restrictions will remain in place for the duration of the project.

- C. **Stage 1 Phase 3** The south lane of East Huron Street may not be closed until cold milling operations are set to begin. Upon placing the top course, open East Huron Street.

- D. **Stage 2 Phase 1** The work zone is limited to the west half of South Division Street from the POB to the north quadrant of East William Street. The Jefferson Street will be closed upon commencement of bumpout construction.

Jefferson Street may remain closed for the duration of the project unless directed other by the Engineer.

- E. **Stage 2 Phase 2A & 2B** The work zone is extended to include the west half of South Division Street to East Huron Street. Traffic restrictions of intersection streets from Stage 1 are still in effect.

- F. **Stage 2 Phase 3** The south lane of East Huron Street may not be closed until cold milling operations are set to begin. Upon placing the top course, open East Huron Street.

d. **Measurement and Payment.** The completed work for maintaining traffic, as described, will be paid for at the contract unit prices for the following items in accordance with subsection 812.04 of the Standard Specifications for Construction.

<u>Pay Item</u>	<u>Pay Unit</u>
Barricade, Type III, High Intensity, Double Sided, Lighted, Furn	Each
Barricade, Type III, High Intensity, Double Sided, Lighted, Oper.....	Each
Channelizing Device, 42 inch, Furn	Each
Channelizing Device, 42 inch, Oper.....	Each
Pavt Mrkg, Longit, 6 inch or Less Width, Rem	Foot
Pavt Mrkg, Type NR, Paint, 4 inch, White, Temp.....	Foot
Pavt Mrkg, Type NR, Paint, 4 inch, Yellow, Temp	Foot
Pavt Mrkg, Type R, 4 inch, White, Temp	Foot
Pavt Mrkg, Type R, 4 inch, Yellow, Temp	Foot
Lighted Arrow, Type C, Furn	Each

Lighted Arrow, Type C, Oper	Each
Plastic Drum, High Intensity, Lighted, Furn	Each
Plastic Drum, High Intensity, Lighted, Oper	Each
Sign, Portable, Changeable Message, Furn	Each
Sign, Portable, Changeable Message, Oper.....	Each
Sign, Type B, Temp, Prismatic, Furn	Square Foot
Sign, Type B, Temp, Prismatic, Oper.....	Square Foot
Traf Regulator Control.....	Lump Sum
Minor Traffic Control, Modified, Max \$____	Lump Sum

The estimated quantities for maintaining traffic are based on the signing and related traffic control devices deemed necessary for this project as shown on the plans and applicable MDOT Maintaining Traffic Typicals, and include traffic regulators, lighted arrows and minor traffic devices.

Payment for furnishing and operating Type III Barricades and 42 inch Channelizing Devices shall be for the maximum quantity in use at any one time during the work for the entire project (all streets).

Measurement and payment for furnishing Lighted Arrows and Portable Changeable Message Signs will be based on the maximum number of units required for the entire project at any one time. Measurement and payment for operating Lighted Arrows and Portable Changeable Message Signs will be based on the maximum number of units in operation at any one time and will be paid after the initial placement into service and for each relocation to another street that follows.

Payment for furnishing and operating Plastic Drums and Temporary Type B Signs shall be for the maximum quantity in use on each street at any one time.

No Parking Signs will be measured as the maximum number installed on each street at any one time. The unit price includes the removal and return of No Parking signs to the City upon completion of the project. The Contractor shall be charged for the replacement cost for each damaged or unreturned sign.

Any additional signing or maintaining traffic devices required to expedite the construction shall be at the Contractor’s expense unless approved by the Engineer.

Temporary traffic control devices will be paid for only once irrespective of the number of times moved. Traffic control devices not paid for separately shall be included in the payment for the pay item “Minor Traffic Control, Modified, Max \$____”.

MINIMUM MERGING TAPER LENGTH "L" (FEET)

OFFSET FEET	POSTED SPEED LIMIT, MPH (PRIOR TO WORK AREA)									
	25	30	35	40	45	50	55	60	65	70
1	10	15	20	27	45	50	55	60	65	70
2	21	30	41	53	90	100	110	120	130	140
3	31	45	61	80	135	150	165	180	195	210
4	42	60	82	107	180	200	220	240	260	280
5	52	75	102	133	225	250	275	300	325	350
6	63	90	123	160	270	300	330	360	390	420
7	73	105	143	187	315	350	385	420	455	490
8	83	120	163	213	360	400	440	480	520	560
9	94	135	184	240	405	450	495	540	585	630
10	104	150	204	267	450	500	550	600	650	700
11	115	165	225	293	495	550	605	660	715	770
12	125	180	245	320	540	600	660	720	780	840
13	135	195	266	347	585	650	715	780	845	910
14	146	210	286	374	630	700	770	840	910	980
15	157	225	307	400	675	750	825	900	975	1050

TAPER LENGTH "L" IN FEET

THE FORMULAS FOR THE MINIMUM LENGTH OF A MERGING TAPER IN DERIVING THE "L" VALUES SHOWN IN THE ABOVE TABLES ARE AS FOLLOWS:

"L" = $\frac{W \times S^2}{60}$ WHERE POSTED SPEED PRIOR TO THE WORK AREA IS 40 MPH OR LESS

"L" = S x W WHERE POSTED SPEED PRIOR TO THE WORK AREA IS 45 MPH OR GREATER

- L = MINIMUM LENGTH OF MERGING TAPER
- S = POSTED SPEED LIMIT IN MPH PRIOR TO WORK AREA
- W = WIDTH OF OFFSET

TYPES OF TAPERS

UPSTREAM TAPERS

- MERGING TAPER
- SHIFTING TAPER
- SHOULDER TAPER
- TWO-WAY TRAFFIC TAPER

DOWNSTREAM TAPERS (USE IS OPTIONAL)

TAPER LENGTH

- L - MINIMUM
- 1/2 L - MINIMUM
- 1/3 L - MINIMUM
- 100' - MAXIMUM
- 100' - MINIMUM (PER LANE)

 TRAFFIC AND SAFETY MAINTAINING TRAFFIC TYPICAL	TABLES FOR "L", "D" AND "B" VALUES		
	DRAWN BY: CON:AE:djf CHECKED BY: BMM	JUNE 2006 PLAN DATE:	M0020a
FILE: K:/DGN/TSR/STDS/ENGLISH/MNTTRF/M0020a.dgn REV. 08/21/2006			

DISTANCE BETWEEN TRAFFIC CONTROL DEVICES "D"
AND LENGTH OF LONGITUDINAL BUFFER SPACE ON
"WHERE WORKERS PRESENT" SEQUENCES

"D" DISTANCES	POSTED SPEED LIMIT, MPH (PRIOR TO WORK AREA)									
	25	30	35	40	45	50	55	60	65	70
D (FEET)	250	300	350	400	450	500	550	600	650	700

GUIDELINES FOR LENGTH OF
LONGITUDINAL BUFFER SPACE "B"

SPEED* MPH	LENGTH FEET
20	33
25	50
30	83
35	132
40	181
45	230
50	279
55	329
60	411
65	476
70	542

* POSTED SPEED, OFF PEAK 85TH PERCENTILE SPEED PRIOR TO WORK STARTING, OR THE ANTICIPATED OPERATING SPEED

1 BASED UPON AMERICAN ASSOCIATION OF STATE HIGHWAY AND TRANSPORTATION OFFICIALS (AASHTO) BRAKING DISTANCE PORTION OF STOPPING SIGHT DISTANCE FOR WET AND LEVEL PAVEMENTS (A POLICY ON GEOMETRIC DESIGN OF HIGHWAY AND STREETS), AASHTO. THIS AASHTO DOCUMENT ALSO RECOMMENDS ADJUSTMENTS FOR THE EFFECT OF GRADE ON STOPPING AND VARIATION FOR TRUCKS.

 TRAFFIC AND SAFETY MAINTAINING TRAFFIC TYPICAL	TABLES FOR "L", "D" AND "B" VALUES		
	DRAWN BY: CON:AE:djf CHECKED BY: BMM	JUNE 2006 PLAN DATE:	M0020a
FILE: K:/DGN/TSR/STDS/ENGLISH/MNTTRF/M0020a.dgn REV. 08/21/2006			

SIGN PLACEMENT IS THE SAME FOR BOTH DIRECTIONS

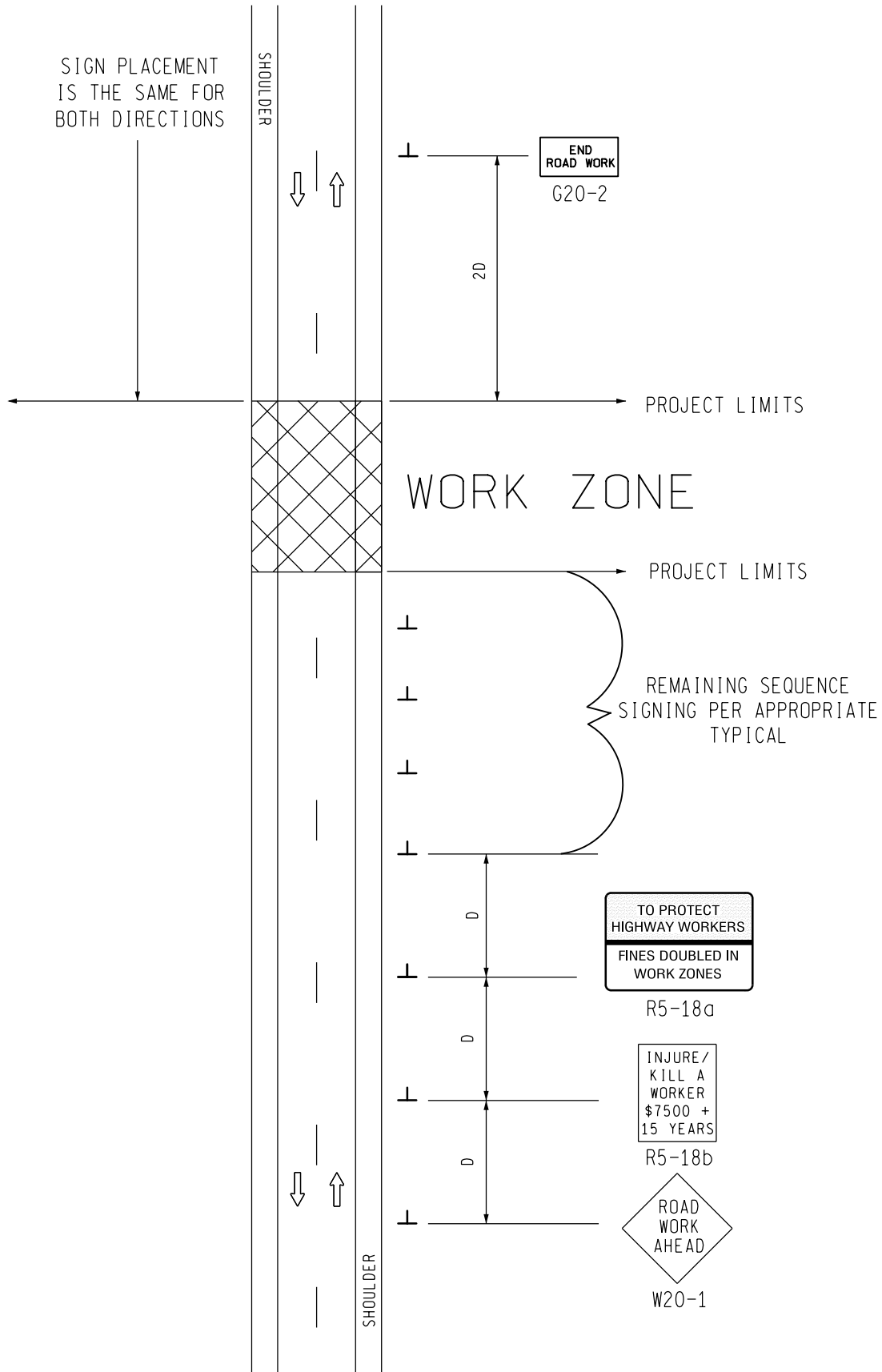

SIGN = 68 f+2 - TYPE B
FOR ONE DIRECTION OF TRAFFIC
W20-1 QUANTITY INCLUDED
WITH APPROPRIATE TYPICAL
FOR SEQUENCE SIGNING

MDOT
Michigan Department of Transportation
TRAFFIC AND SAFETY
MAINTAINING TRAFFIC
TYPICAL

TYPICAL ADVANCE SIGNING TREATMENT FOR LONG, INTERMEDIATE AND SHORT TERM STATIONARY WORK ZONE OPERATIONS OF LESS THAN TWO MILES IN LENGTH WHERE TRAFFIC CONTROL DEVICES MAY REMAIN AT END OF WORK DAY ON AN UNDIVIDED TWO-WAY ROADWAY

DRAWN BY: CON:AE:djf
CHECKED BY: BMM:CRB

OCTOBER 2011
PLAN DATE:

M0040a

SHEET
1 OF 2

NOT TO SCALE

FILE: PW_RD/TS/Typicals/Signs/MT NON FWY/M0040a.dgn REV. 10/13/2011

NOTES

30. THE APPROPRIATE ADVANCE SIGNING SEQUENCE(S), (M0030a THROUGH M0080a) SHALL BE USED ON ALL PROJECTS.
32. THESE SIGNS SHALL BE LEFT IN PLACE AT THEIR PRESCRIBED LOCATIONS FOR THE DURATION OF THE PROJECT AND UNTIL ALL TEMPORARY TRAFFIC CONTROL HAS BEEN REMOVED.
35. THESE SIGNS ARE INTENDED TO BE USED WITHIN THE LIMITS OF THE TEMPORARY SEQUENCE SIGNING AS IS SHOWN ON 1 OF 2. THESE SIGNS ARE NOT TO BE INTERMINGLED WITH ANY OTHER TEMPORARY SEQUENCE SIGNING EXCEPT AS SHOWN.



SIGN SIZES

G20-2	-	48" x 24"
R5-18a	-	96" x 60"
R5-18b	-	48" x 60"
W20-1	-	48" x 48"

 TRAFFIC AND SAFETY MAINTAINING TRAFFIC TYPICAL	TYPICAL ADVANCE SIGNING TREATMENT FOR LONG, INTERMEDIATE AND SHORT TERM STATIONARY WORK ZONE OPERATIONS OF LESS THAN TWO MILES IN LENGTH WHERE TRAFFIC CONTROL DEVICES MAY REMAIN AT END OF WORK DAY ON AN UNDIVIDED TWO-WAY ROADWAY		
	DRAWN BY: CON:AE:djf	OCTOBER 2011	M0040a
CHECKED BY: BMM:CRB	PLAN DATE:	2 OF 2	
FILE: PW_RD/TS/Typicals/Signs/MT NON FWY/M0040a.dgn REV. 10/13/2011			

NOT TO SCALE

KEY

- • • CHANNELIZING DEVICES
-  LIGHTED ARROW PANEL (CAUTION MODE)
-  TRAFFIC FLOW
- REFLECTS EXISTING SPEED LIMIT
- * USE THE "NEXT -- MILES" SIGN WHEN SHOULDER CLOSURE EXCEEDS 1 MILE IN LENGTH

SIGN = 120 ft± - TYPE B
 W/PLAQUE = 132 ft± - TYPE B
 PLUS ADDITIONAL R2-1's
 THROUGHOUT WORK AREA

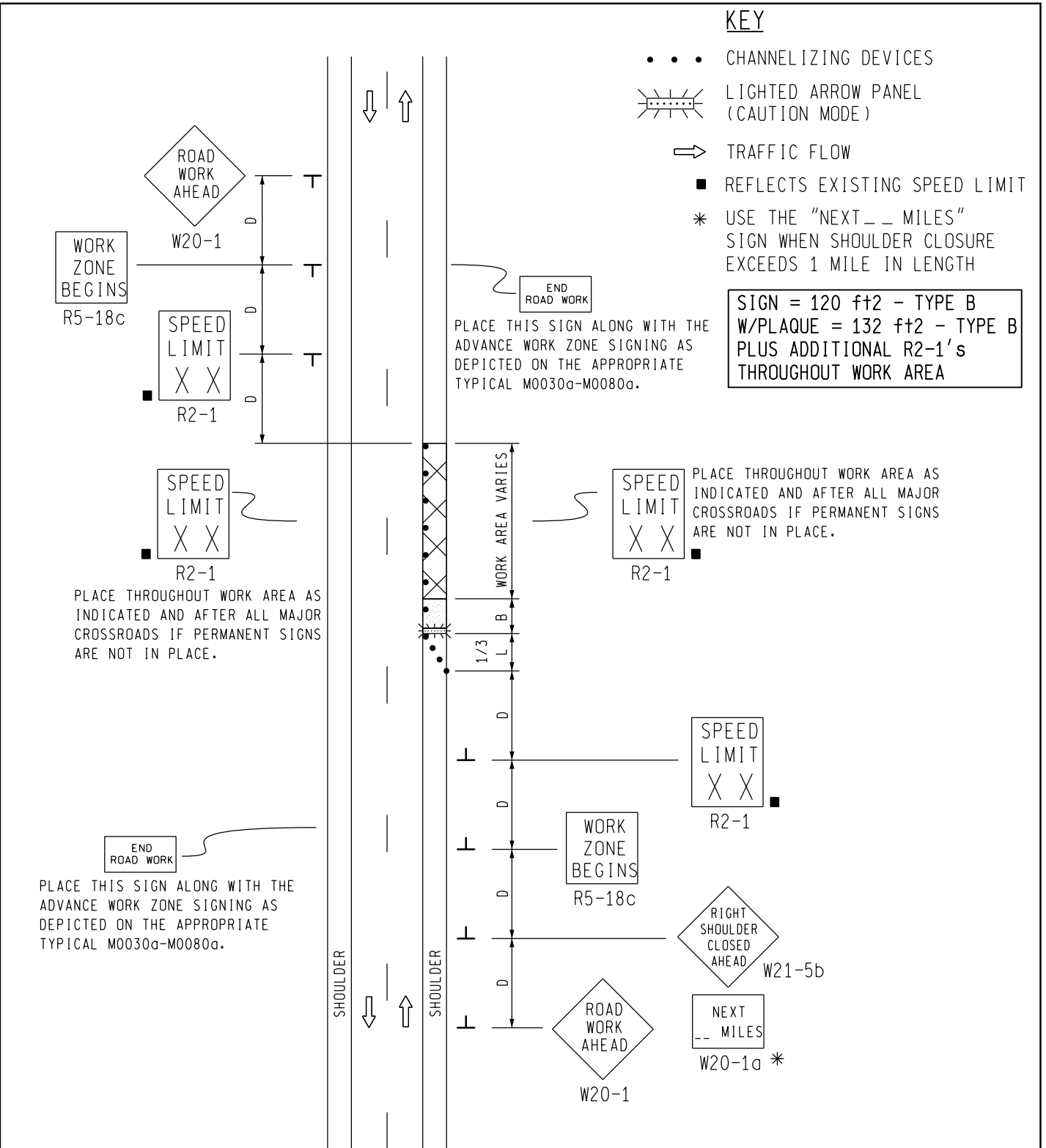

 Michigan Department of Transportation TRAFFIC AND SAFETY MAINTAINING TRAFFIC TYPICAL	TYPICAL TEMPORARY TRAFFIC CONTROL FOR A SHOULDER CLOSURE ON A TWO LANE TWO-WAY ROADWAY NO SPEED REDUCTION		
	DRAWN BY: CON:AE:djf CHECKED BY: BMM:CRB	OCTOBER 2011 PLAN DATE:	M0110a
FILE: PW_RD/TS/Typicals/Signs/MT NON FWY/M0110a.dgn REV. 10/04/2011			

NOT TO SCALE

NOTES

1. D = DISTANCE BETWEEN TRAFFIC CONTROL DEVICES
 $1/3 L$ = MINIMUM LENGTH OF TAPER
 B = LENGTH OF LONGITUDINAL BUFFER
 SEE M0020a FOR "D," "L," AND "B" VALUES
2. ALL NON-APPLICABLE SIGNING WITHIN THE CIA SHALL BE MODIFIED TO FIT CONDITIONS, COVERED OR REMOVED.
3. DISTANCES BETWEEN SIGNS, THE VALUES FOR WHICH ARE SHOWN IN TABLE D, ARE APPROXIMATE AND MAY NEED ADJUSTING AS DIRECTED BY THE ENGINEER.
- 3A. THE "WORK ZONE BEGINS" (R5-18c) SIGN SHALL BE USED ONLY IN THE INITIAL SIGNING SEQUENCE IN THE WORK ZONE. SUBSEQUENT SEQUENCES IN THE SAME WORK ZONE SHALL OMIT THIS SIGN AND THE QUANTITIES SHALL BE ADJUSTED APPROPRIATELY.
- 4E. THE MAXIMUM RECOMMENDED DISTANCE(S) BETWEEN CHANNELIZING DEVICES SHOULD BE EQUAL IN FEET TO THE POSTED SPEED IN MILES PER HOUR ON TAPER(S) AND TWICE THE POSTED SPEED IN THE PARALLEL AREA(S).
5. FOR OVERNIGHT CLOSURES, TYPE III BARRICADES SHALL BE LIGHTED.
6. WHEN CALLED FOR IN THE FHWA ACCEPTANCE LETTER FOR THE SIGN SYSTEM SELECTED, THE TYPE A WARNING FLASHER, SHOWN ON THE WARNING SIGNS, SHALL BE POSITIONED ON THE SIDE OF THE SIGN NEAREST THE ROADWAY.
7. ALL TEMPORARY SIGNS, TYPE III BARRICADES, THEIR SUPPORT SYSTEMS AND LIGHTING REQUIREMENTS SHALL MEET NCHRP 350 CRASHWORTHLY REQUIREMENTS STIPULATED IN THE CURRENT EDITION OF THE MICHIGAN MANUAL ON UNIFORM TRAFFIC CONTROL DEVICES, THE CURRENT EDITION OF THE STANDARD SPECIFICATIONS FOR CONSTRUCTION, THE STANDARD PLANS AND APPLICABLE SPECIAL PROVISIONS. ONLY DESIGNS AND MATERIALS APPROVED BY MDOT WILL BE ALLOWED.
8. WHEN BUFFER AREAS ARE ESTABLISHED, THERE SHALL BE NO EQUIPMENT OR MATERIALS STORED OR WORK CONDUCTED IN THE BUFFER AREA.
- 29A. THE TYPE OF REFLECTIVE SHEETING USED FOR THE W20-1a PLAQUE SHALL BE THE SAME AS THE TYPE USED FOR THE PARENT SIGN.

SIGN SIZES

DIAMOND WARNING	- 48" x 48"
W20-1a PLAQUE	- 48" x 36"
R2-1 REGULATORY	- 48" x 60"
R5-18c REGULATORY	- 48" x 48"

NOT TO SCALE

 TRAFFIC AND SAFETY MAINTAINING TRAFFIC TYPICAL	TYPICAL TEMPORARY TRAFFIC CONTROL FOR A SHOULDER CLOSURE ON A TWO LANE TWO-WAY ROADWAY NO SPEED REDUCTION	
	DRAWN BY: CON:AE:djf CHECKED BY: BMM:CRB	OCTOBER 2011 PLAN DATE:
FILE: PW_RD/TS/Typicals/Signs/MT NON FWY/M0110a.dgn REV. 10/04/2011		





PLACE THROUGHOUT WORK AREA AS INDICATED AND AFTER ALL MAJOR CROSSROADS IF PERMANENT SIGNS ARE NOT IN PLACE.

PLACE THIS SIGN ALONG WITH THE ADVANCE WORK ZONE SIGNING AS DEPICTED ON THE APPROPRIATE TYPICAL M0030a-M0080a.

PLACE THROUGHOUT WORK AREA AS INDICATED AND AFTER ALL MAJOR CROSSROADS IF PERMANENT SIGNS ARE NOT IN PLACE.

PLACE THIS SIGN ALONG WITH THE ADVANCE WORK ZONE SIGNING AS DEPICTED ON THE APPROPRIATE TYPICAL M0030a-M0080a.

KEY

-  TRAFFIC REGULATOR
-  CHANNELIZING DEVICES
-  LIGHTED ARROW PANEL (CAUTION MODE)
-  TRAFFIC FLOW
-  REFLECTS EXISTING SPEED LIMIT

SIGN = 200 ft± - TYPE B PLUS ADDITIONAL R2-1's THROUGHOUT WORK AREA

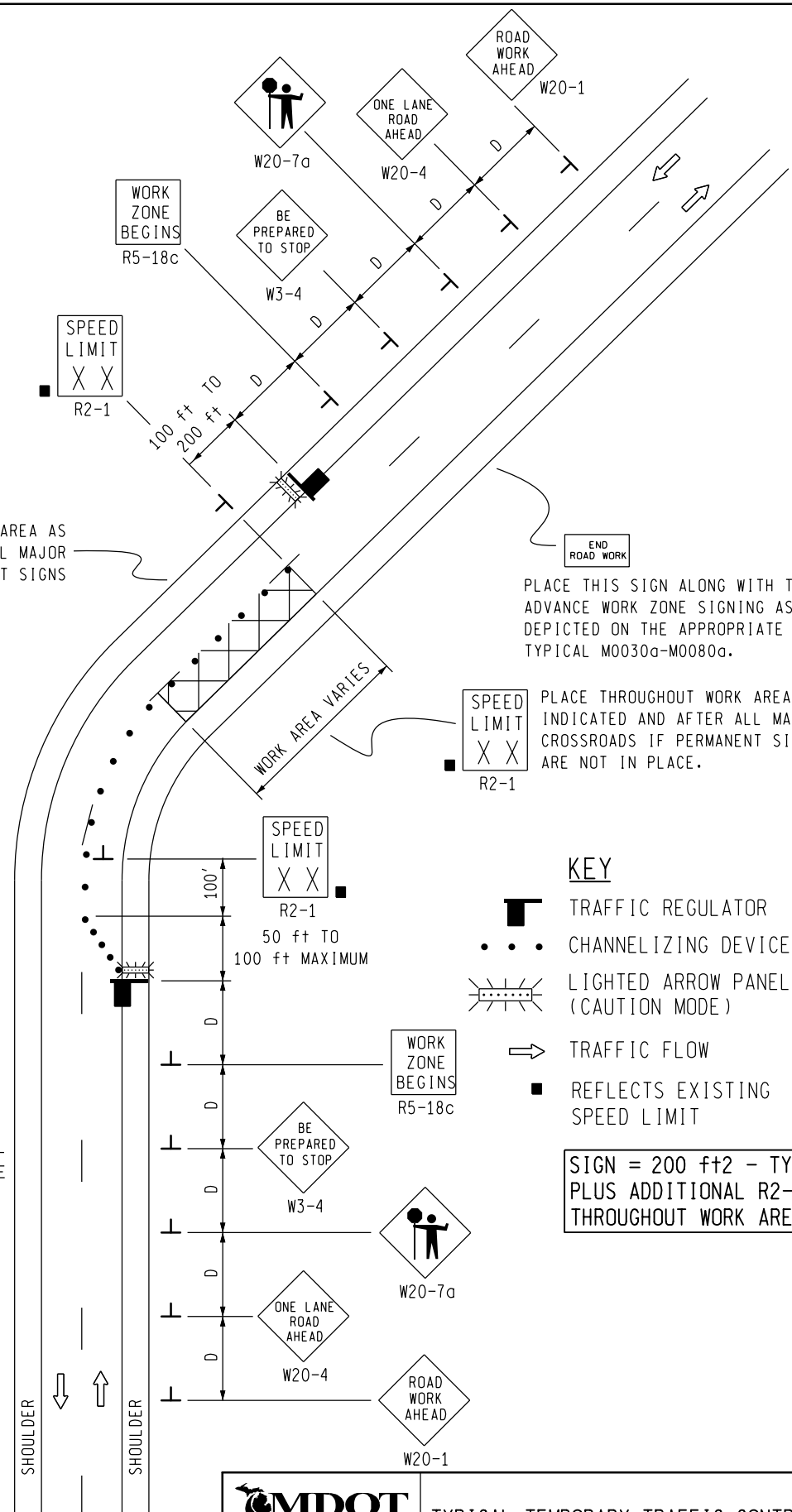

TRAFFIC AND SAFETY
MAINTAINING TRAFFIC
TYPICAL

TYPICAL TEMPORARY TRAFFIC CONTROL FOR A TWO-LANE TWO-WAY ROADWAY WHERE ONE LANE IS CLOSED UTILIZING TRAFFIC REGULATORS, NO SPEED REDUCTION

DRAWN BY: CON:AE:djf
CHECKED BY: BMM:CRB

OCTOBER 2011
PLAN DATE:

M0140a

SHEET
1 OF 2

NOT TO SCALE

NOTES

- 1H. D = DISTANCE BETWEEN TRAFFIC CONTROL DEVICES AND LENGTH OF LONGITUDINAL BUFFERS
SEE **M0020a** FOR "D" VALUES.
2. ALL NON-APPLICABLE SIGNING WITHIN THE CIA SHALL BE MODIFIED TO FIT CONDITIONS, COVERED OR REMOVED.
3. DISTANCES BETWEEN SIGNS, THE VALUES FOR WHICH ARE SHOWN IN TABLE D, ARE APPROXIMATE AND MAY NEED ADJUSTING AS DIRECTED BY THE ENGINEER.
- 3A. THE "WORK ZONE BEGINS" (R5-18c) SIGN SHALL BE USED ONLY IN THE INITIAL SIGNING SEQUENCE IN THE WORK ZONE. SUBSEQUENT SEQUENCES IN THE SAME WORK ZONE SHALL OMIT THIS SIGN AND THE QUANTITIES SHALL BE ADJUSTED APPROPRIATELY.
- 4A. THE MAXIMUM RECOMMENDED DISTANCE(S) BETWEEN CHANNELIZING DEVICES IN THE TAPER AREA(S) SHOULD BE 15 FEET AND SHOULD BE EQUAL IN FEET TO TWICE THE POSTED SPEED IN MILES PER HOUR IN THE PARALLEL AREA(S).
5. FOR OVERNIGHT CLOSURES, TYPE III BARRICADES SHALL BE LIGHTED.
6. WHEN CALLED FOR IN THE FHWA ACCEPTANCE LETTER FOR THE SIGN SYSTEM SELECTED, THE TYPE A WARNING FLASHER, SHOWN ON THE WARNING SIGNS, SHALL BE POSITIONED ON THE SIDE OF THE SIGN NEAREST THE ROADWAY.
7. ALL TEMPORARY SIGNS, TYPE III BARRICADES, THEIR SUPPORT SYSTEMS AND LIGHTING REQUIREMENTS SHALL MEET NCHRP 350 CRASHWORTHLY REQUIREMENTS STIPULATED IN THE CURRENT EDITION OF THE MICHIGAN MANUAL ON UNIFORM TRAFFIC CONTROL DEVICES, THE CURRENT EDITION OF THE STANDARD SPECIFICATIONS FOR CONSTRUCTION, THE STANDARD PLANS AND APPLICABLE SPECIAL PROVISIONS. ONLY DESIGNS AND MATERIALS APPROVED BY MDOT WILL BE ALLOWED.
9. ALL TRAFFIC REGULATORS SHALL BE PROPERLY TRAINED AND SUPERVISED.
- 9A. IN ANY OPERATION INVOLVING MORE THAN ONE TRAFFIC REGULATOR, ONE PERSON SHOULD BE DESIGNATED AS HEAD TRAFFIC REGULATOR.
10. ALL TRAFFIC REGULATORS' CONDUCT, THEIR EQUIPMENT, AND TRAFFIC REGULATING PROCEDURES SHALL CONFORM TO THE CURRENT EDITION OF THE MICHIGAN MANUAL OF UNIFORM TRAFFIC CONTROL DEVICES (MMUTCD) AND THE CURRENT EDITION OF THE MDOT HANDBOOK ENTITLED "TRAFFIC REGULATORS INSTRUCTION MANUAL."
11. WHEN TRAFFIC REGULATING IS ALLOWED DURING THE HOURS OF DARKNESS, APPROPRIATE LIGHTING SHALL BE PROVIDED TO SUFFICIENTLY ILLUMINATE THE TRAFFIC REGULATOR'S STATIONS.
- 12E. THE MAXIMUM DISTANCE BETWEEN THE TRAFFIC REGULATORS SHALL BE NO MORE THAN 2 MILES IN LENGTH UNLESS RESTRICTED FURTHER IN THE SPECIAL PROVISIONS FOR MAINTAINING TRAFFIC. ALL SEQUENCES OF MORE THAN 2 MILES IN LENGTH WILL REQUIRE WRITTEN PERMISSION FROM THE ENGINEER BEFORE PROCEEDING.
13. WHEN INTERSECTING ROADS OR SIGNIFICANT TRAFFIC GENERATORS (SHOPPING CENTERS, MOBILE HOME PARKS, ETC.) OCCUR WITHIN THE ONE-LANE TWO-WAY OPERATION, INTERMEDIATE TRAFFIC REGULATORS AND APPROPRIATE SIGNING SHALL BE PLACED AT THESE LOCATIONS.
14. ADDITIONAL SIGNING AND/OR ELONGATED SIGNING SEQUENCES SHOULD BE USED WHEN TRAFFIC VOLUMES ARE SIGNIFICANT ENOUGH TO CREATE BACKUPS BEYOND THE W3-4 SIGNS.
15. THE HAND HELD (PADDLE) SIGNS REQUIRED BY THE MMUTCD TO CONTROL TRAFFIC WILL BE PAID FOR AS PART OF FLAG CONTROL.
- 28E. THE TRAFFIC REGULATORS SHOULD BE POSITIONED AT OR NEAR THE SIDE OF THE ROAD SO THAT THEY ARE SEEN CLEARLY AT A MINIMUM DISTANCE OF 500 FEET. THIS MAY REQUIRE EXTENDING THE BEGINNING OF THE LANE CLOSURE TO OVERCOME VIEWING PROBLEMS CAUSED BY HILLS AND CURVES.

SIGN SIZES

DIAMOND WARNING - 48" x 48"
 R2-1 REGULATORY - 48" x 60"
 R5-18c REGULATORY - 48" x 48"

NOT TO SCALE

 TRAFFIC AND SAFETY MAINTAINING TRAFFIC TYPICAL	TYPICAL TEMPORARY TRAFFIC CONTROL FOR A TWO-LANE TWO-WAY ROADWAY WHERE ONE LANE IS CLOSED UTILIZING TRAFFIC REGULATORS, NO SPEED REDUCTION		
DRAWN BY: CON:AE:djf	OCTOBER 2011	M0140a	SHEET
CHECKED BY: BMM:CRB	PLAN DATE:		2 OF 2
FILE: PW_RD/TS/Typicals/Signs/MT NON FWY/M0140a.dgn REV. 10/04/2011			

KEY

- • • CHANNELIZING DEVICES
- ⚡ LIGHTED ARROW PANEL
- ➡ TRAFFIC FLOW
- REFLECTS EXISTING SPEED LIMIT

SIGN = 136 ft±2 - TYPE B PLUS ADDITIONAL R2-1's THROUGHOUT WORK AREA

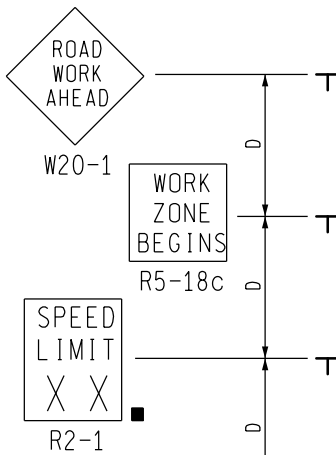

END ROAD WORK
PLACE THIS SIGN ALONG WITH THE ADVANCE WORK ZONE SIGNING AS DEPICTED ON THE APPROPRIATE TYPICAL M0030a-M0080a.



PLACE THROUGHOUT WORK AREA AS INDICATED AND AFTER ALL MAJOR CROSSROADS IF PERMANENT SIGNS ARE NOT IN PLACE.

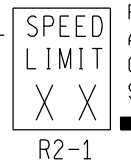

PLACE THROUGHOUT WORK AREA AS INDICATED AND AFTER ALL CROSSROADS IF PERMANENT SIGNS ARE NOT IN PLACE.

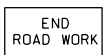

PLACE THIS SIGN ALONG WITH THE ADVANCE WORK ZONE SIGNING AS DEPICTED ON THE APPROPRIATE TYPICAL M0030a-M0080a.

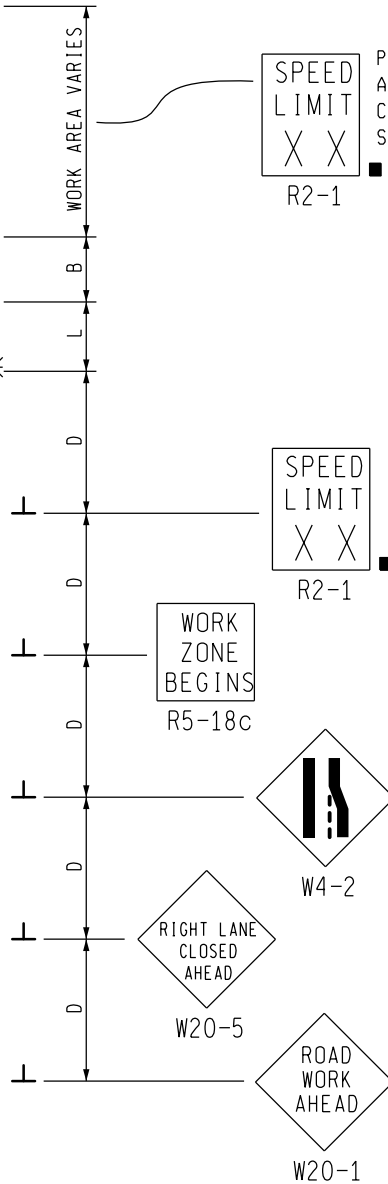
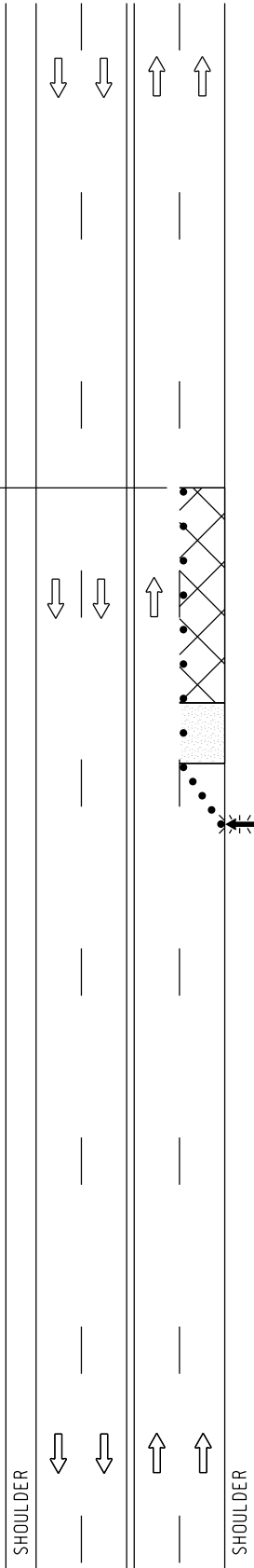

MDOT
Michigan Department of Transportation
TRAFFIC AND SAFETY
MAINTAINING TRAFFIC
TYPICAL

TYPICAL TEMPORARY TRAFFIC CONTROL
FOR A ONE-LANE CLOSURE ON AN
UNDIVIDED MULTI-LANE ROADWAY,
NO SPEED REDUCTION

DRAWN BY: CON:AE:djf
CHECKED BY: BMM:CRB

OCTOBER 2011
PLAN DATE:

M0240a

SHEET
1 OF 2

NOT TO SCALE

FILE: PW_RD/TS/Typicals/Signs/MT NON FWY/M0240a.dgn REV. 10/11/2011

NOTES

- 1B. D = DISTANCE BETWEEN TRAFFIC CONTROL DEVICES
L = MINIMUM LENGTH OF TAPER
B = LENGTH OF LONGITUDINAL BUFFER
SEE M0020a FOR "D," "L," AND "B" VALUES
2. ALL NON-APPLICABLE SIGNING WITHIN THE CIA SHALL BE MODIFIED TO FIT CONDITIONS, COVERED OR REMOVED.
3. DISTANCES BETWEEN SIGNS, THE VALUES FOR WHICH ARE SHOWN IN TABLE D, ARE APPROXIMATE AND MAY NEED ADJUSTING AS DIRECTED BY THE ENGINEER.
- 3A. THE "WORK ZONE BEGINS" (R5-18c) SIGN SHALL BE USED ONLY IN THE INITIAL SIGNING SEQUENCE IN THE WORK ZONE. SUBSEQUENT SEQUENCES IN THE SAME WORK ZONE SHALL OMIT THIS SIGN AND THE QUANTITIES SHALL BE ADJUSTED APPROPRIATELY.
- 4E. THE MAXIMUM RECOMMENDED DISTANCE(S) BETWEEN CHANNELIZING DEVICES SHOULD BE EQUAL IN FEET TO THE POSTED SPEED IN MILES PER HOUR ON TAPER(S) AND TWICE THE POSTED SPEED IN THE PARALLEL AREA(S).
5. FOR OVERNIGHT CLOSURES, TYPE III BARRICADES SHALL BE LIGHTED.
6. WHEN CALLED FOR IN THE FHWA ACCEPTANCE LETTER FOR THE SIGN SYSTEM SELECTED, THE TYPE A WARNING FLASHER, SHOWN ON THE WARNING SIGNS, SHALL BE POSITIONED ON THE SIDE OF THE SIGN NEAREST THE ROADWAY.
7. ALL TEMPORARY SIGNS, TYPE III BARRICADES, THEIR SUPPORT SYSTEMS AND LIGHTING REQUIREMENTS SHALL MEET NCHRP 350 CRASHWORTHLY REQUIREMENTS STIPULATED IN THE CURRENT EDITION OF THE MICHIGAN MANUAL ON UNIFORM TRAFFIC CONTROL DEVICES, THE CURRENT EDITION OF THE STANDARD SPECIFICATIONS FOR CONSTRUCTION, THE STANDARD PLANS AND APPLICABLE SPECIAL PROVISIONS. ONLY DESIGNS AND MATERIALS APPROVED BY MDOT WILL BE ALLOWED.
8. WHEN BUFFER AREAS ARE ESTABLISHED, THERE SHALL BE NO EQUIPMENT OR MATERIALS STORED OR WORK CONDUCTED IN THE BUFFER AREA.
21. ALL EXISTING PAVEMENT MARKINGS WHICH ARE IN CONFLICT WITH EITHER PROPOSED CHANGES IN TRAFFIC PATTERNS OR PROPOSED TEMPORARY TRAFFIC MARKINGS, SHALL BE REMOVED BEFORE ANY CHANGE IS MADE IN THE TRAFFIC PATTERN. EXCEPTION WILL BE MADE FOR DAYTIME-ONLY TRAFFIC PATTERNS THAT ARE ADEQUATELY DELINEATED BY OTHER TRAFFIC CONTROL DEVICES.
26. THE LIGHTED ARROW PANEL SHALL BE LOCATED AT THE BEGINNING OF THE TAPER AS SHOWN. WHEN PHYSICAL LIMITATIONS RESTRICT ITS PLACEMENT AS INDICATED, THEN IT SHALL BE PLACED AS CLOSE TO THE BEGINNING OF THE TAPER AS POSSIBLE.

SIGN SIZES

DIAMOND WARNING - 48" x 48"
R2-1 REGULATORY - 48" x 60"
R5-18c REGULATORY - 48" x 48"

NOT TO SCALE

 TRAFFIC AND SAFETY MAINTAINING TRAFFIC TYPICAL	TYPICAL TEMPORARY TRAFFIC CONTROL FOR A ONE-LANE CLOSURE ON AN UNDIVIDED MULTI-LANE ROADWAY, NO SPEED REDUCTION		
	DRAWN BY: CON:AE:djf	OCTOBER 2011	M0240a
CHECKED BY: BMM:CRB	PLAN DATE:	2 OF 2	
FILE: PW_RD/TS/Typicals/Signs/MT NON FWY/M0240a.dgn REV. 10/11/2011			

SIGN MATERIAL SELECTION TABLE

SIGN SIZE	SIGN MATERIAL TYPE		
	TYPE I	TYPE II	TYPE III
≤ 36" X 36"		X	X
>36" X 36" ≤ 96" TO WIDE		X	
> 96" WIDE TO 144" WIDE	X	X	
> 144" WIDE	X		

TYPE I ALUMINUM EXTRUSION
 TYPE II PLYWOOD
 TYPE III ALUMINUM SHEET

ROUNDING OF CORNERS IS NOT REQUIRED FOR TYPE I OR II SIGNS.
 VERTICAL JOINTS ARE NOT PERMITTED.
 HORIZONTAL JOINTS THROUGH SIGN LEGEND OR SYMBOLS ARE NOT PERMITTED.

POST SIZE REQUIREMENTS TABLE

SIGN AREA (ft ²)	POST TYPE		
	U-CHANNEL STEEL	SQUARE TUBULAR STEEL	WOOD
≤9	1 - 3 lb/ft*	1 - 2" 12 or 14 GA*	N/A
9 ≤ 20	2 - 3 lb/ft	2 - 2" 12 or 14 GA	1 - 4" X 6"*
> 20 ≤ 30	N/A	N/A	2 - 4" X 6"
> 30 ≤ 60	N/A	N/A	2 - 6" X 8"
> 60 ≤ 84	N/A	N/A	3 - 6" X 8"

*SIGNS 4 FEET AND GREATER IN WIDTH REQUIRE 2 POSTS.
 SIGNS GREATER THAN 8 FEET IN WIDTH REQUIRE 2 OR 3 WOOD
 POSTS DEPENDING ON AREA OF SIGN.
 A MAXIMUM OF 2 POSTS WITHIN A 7' PATH IS PERMITTED.

NOT TO SCALE

File:PW/Doc/RD/T&S/Typ/Dev/Sign MainTraf D/WZD-100-A Rev. 8/21/06 ECH

 PREPARED BY TRAFFIC AND SAFETY SUPPORT AREA DRAWN BY: CON/ECH CHECKED BY: AUG	_____ ENGINEER OF DELIVERY _____ ENGINEER OF DEVELOPMENT PENDING _____ FHWA APPROVAL DATE	MICHIGAN DEPARTMENT OF TRANSPORTATION BUREAU OF HIGHWAYS DELIVERY STANDARD PLAN FOR GROUND DRIVEN SIGN SUPPORTS FOR TEMP SIGNS		
	8/2006	WZD-100-A	SHEET	
	PLAN DATE		1 of 11	

NOTE: THE ORIGINAL SIGNED COPY IS KEPT ON FILE AT THE MICHIGAN DEPARTMENT OF TRANSPORTATION.

2 POST SIGN SUPPORT SPACING

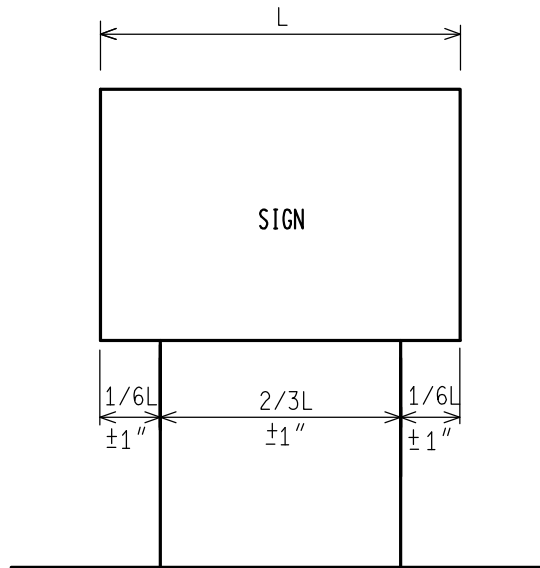

3 POST SIGN SUPPORT SPACING

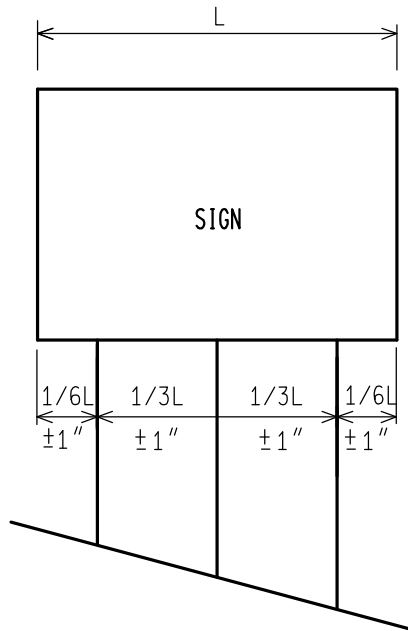

* FOR ALL 11' AND 12' LONG SIGNS ON 3 WOOD SUPPORTS, SPREAD POSTS SO AS TO HAVE A 8' MIN. TO 9' MAX. DISTANCE BETWEEN OUTSIDE POSTS.

NOT TO SCALE

MICHIGAN DEPARTMENT OF TRANSPORTATION BUREAU OF HIGHWAYS DELIVERY STANDARD PLAN	PENDING FHWA APPROVAL DATE	8/2006 PLAN DATE	WZD-100-A	SHEET 2 of 11
File:PW/Doc/RD/T&S/Typ/Dev/Sign MainTraf D/WZD-100-A Rev. 8/21/06 ECH				

NOTE: THE ORIGINAL SIGNED COPY IS KEPT ON FILE AT THE MICHIGAN DEPARTMENT OF TRANSPORTATION.

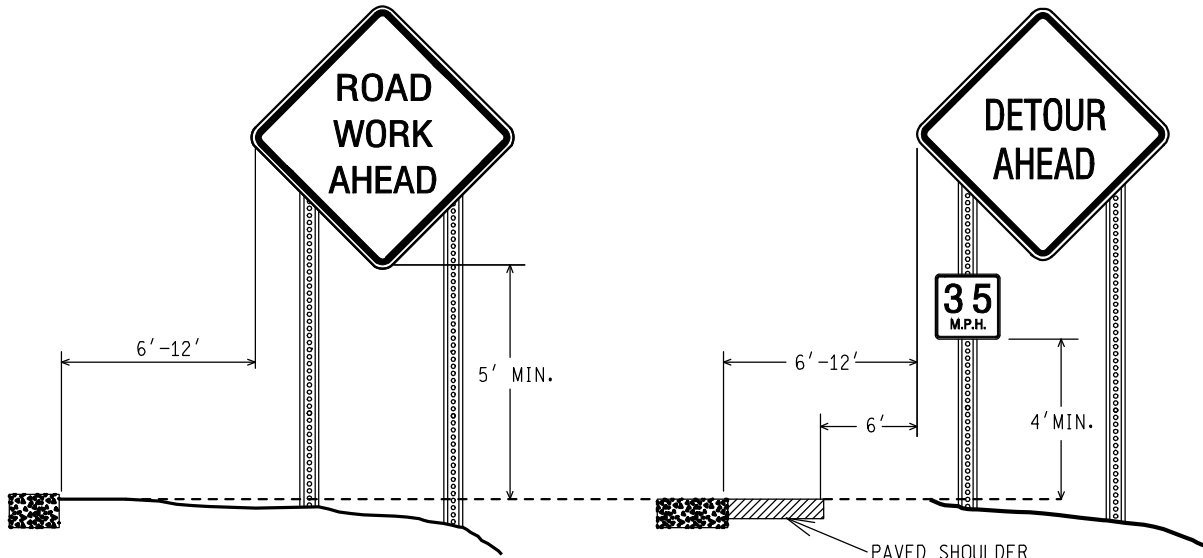

RURAL

RURAL WITH ADVISORY SPEED PLATE

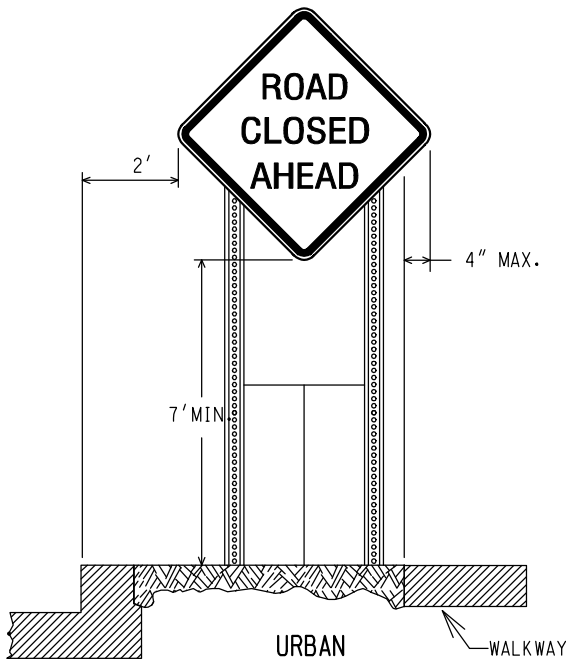

URBAN

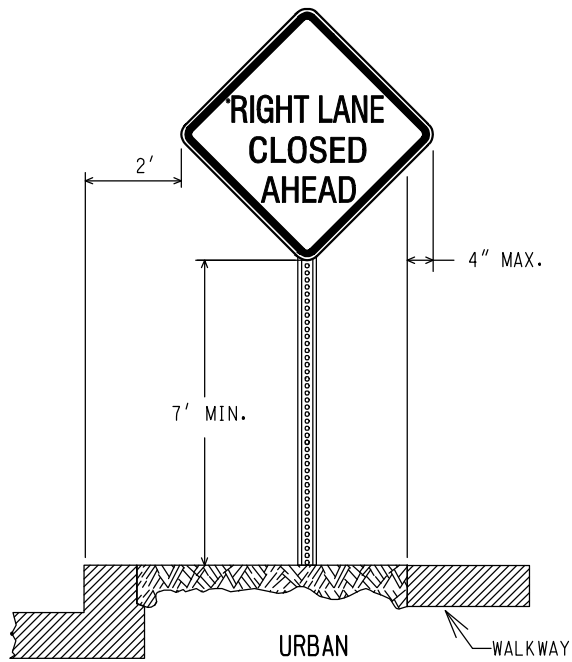

URBAN

(CURBED AREAS OR WHERE WALKWAYS ARE PRESENT)

(CURBED AREAS OR WHERE WALKWAYS ARE PRESENT)

BOTTOM HEIGHT AND OFFSET

NOT TO SCALE

MICHIGAN DEPARTMENT OF TRANSPORTATION
BUREAU OF HIGHWAYS DELIVERY STANDARD PLAN

PENDING
FHWA APPROVAL DATE

8/2006

WZD-100-A

SHEET
3 of 11

File:PW/Doc/RD/T&S/Typ/Dev/Sign MainTraf D/WZD-100-A Rev. 8/21/06 ECH

PLAN DATE

NOTE: THE ORIGINAL SIGNED COPY IS KEPT ON FILE AT THE MICHIGAN DEPARTMENT OF TRANSPORTATION.

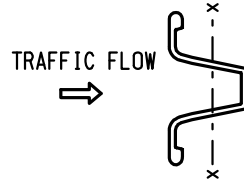
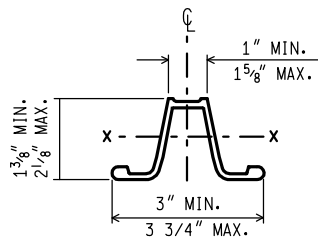
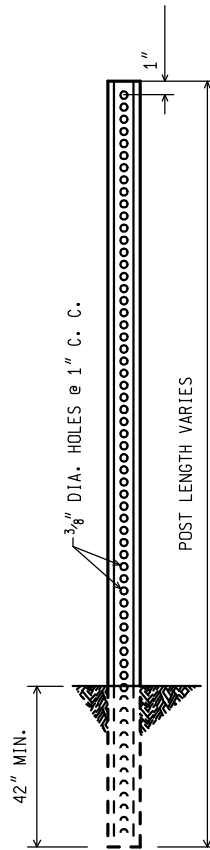

WEIGHT = 3 lbs/ft
 SECT. MOD. X.-X. = 0.31 CUBIC INCHES MIN.

3 lb. U - CHANNEL STEEL POST (NO SPLICE)

MOUNT SIGN ON OPEN FACE OF
 U - CHANNEL STEEL POST

NOT TO SCALE

MICHIGAN DEPARTMENT OF TRANSPORTATION
 BUREAU OF HIGHWAYS DELIVERY STANDARD PLAN

PENDING

 FHWA APPROVAL DATE

8/2006
 PLAN DATE

WZD-100-A

SHEET
 4 of 11

File:PW/Doc/RD/T&S/Typ/Dev/Sign MainTraf D/WZD-100-A Rev. 8/21/06 ECH

NOTE: THE ORIGINAL SIGNED COPY IS KEPT ON FILE AT THE MICHIGAN DEPARTMENT OF TRANSPORTATION.

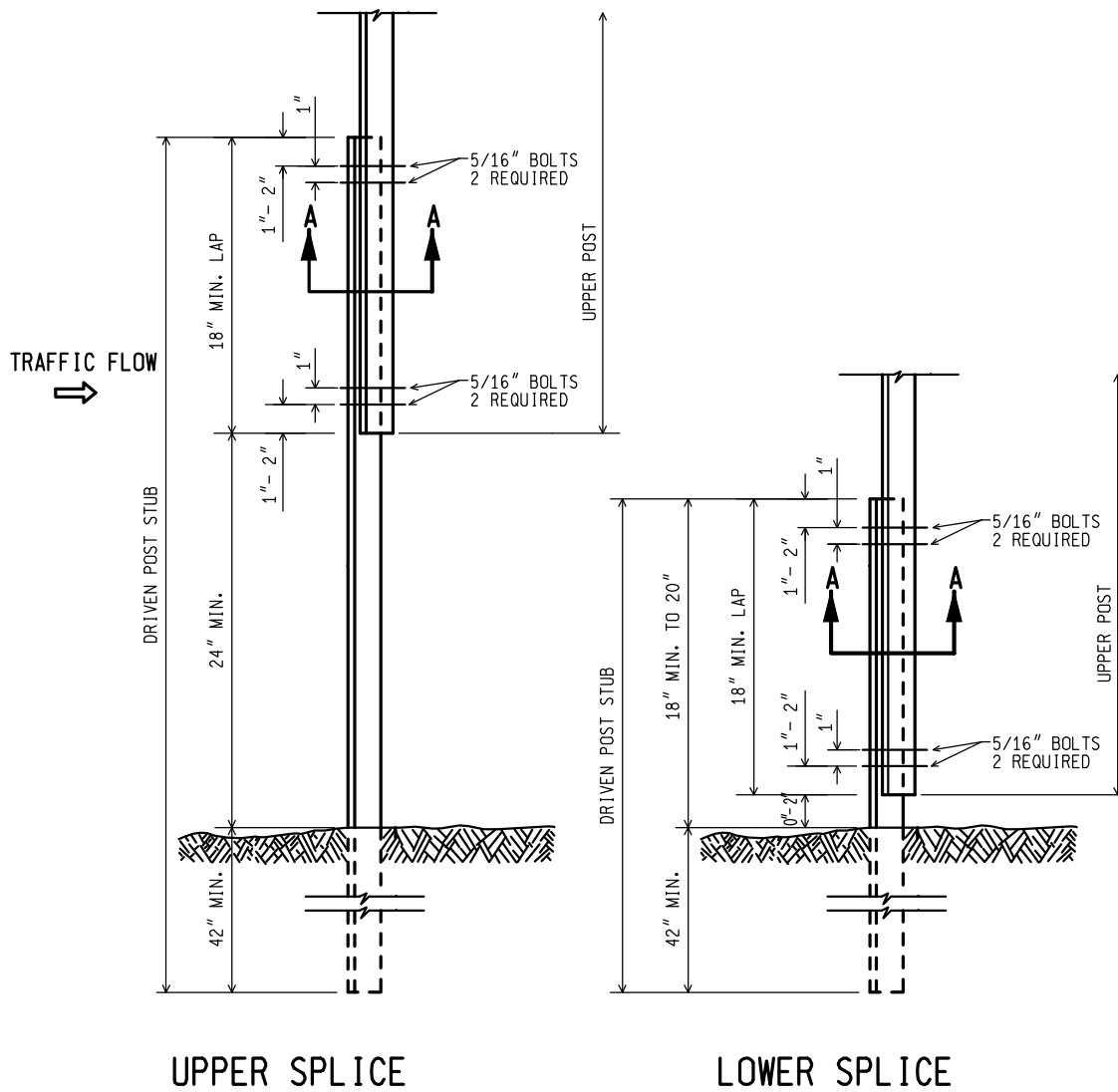

**3 lb. U - CHANNEL STEEL POST
(WITH SPLICE)**

MOUNT SIGN ON OPEN FACE OF
UPPER U - CHANNEL STEEL POST

NOT TO SCALE

MICHIGAN DEPARTMENT OF TRANSPORTATION
BUREAU OF HIGHWAYS DELIVERY STANDARD PLAN

PENDING
FHWA APPROVAL DATE

8/2006
PLAN DATE

WZD-100-A

SHEET
5 of 11

File:PW/Doc/RD/T&S/Typ/Dev/Sign MainTraf D/WZD-100-A Rev. 8/21/06 ECH

NOTE: THE ORIGINAL SIGNED COPY IS KEPT ON FILE AT THE MICHIGAN DEPARTMENT OF TRANSPORTATION.

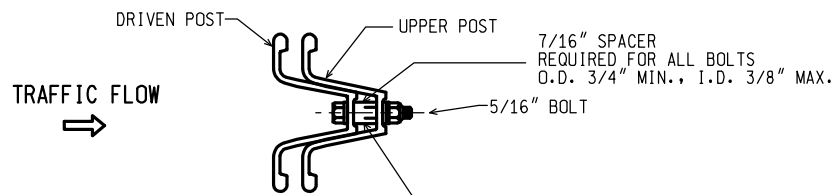

SECTION A-A

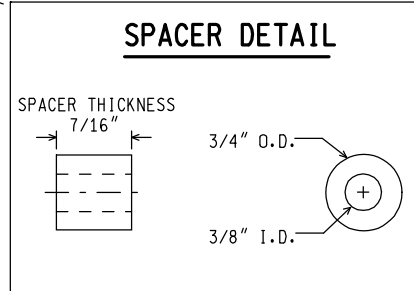

NOTES:

1. THE SPACER THICKNESS SHALL BE 1/16" LESS THAN THE GAP BETWEEN THE POST WHEN POSITIONED IN THE UNBOLTED CONFIGURATION.
2. THE EXTERIOR BOLT (CLOSEST TO LAP), SPACER, WASHER, AND NUT SHALL BE INSTALLED IN A PREPUNCHED HOLE 1" TO 2" FROM THE END OF THE LAP.
3. THE INTERIOR BOLT (FARTHEST FROM LAP), SPACER, WASHER, AND NUT SHALL BE INSTALLED IN THE NEXT PREPUNCHED HOLE.
4. THE DRIVEN POST SHALL ALWAYS BE MOUNTED IN FRONT OF THE UPPER POST WITH RESPECT TO THE ADJACENT ONCOMING TRAFFIC, REGARDLESS OF THE DIRECTION THE SIGN IS FACING.
5. THE SPLICE LAP SHALL BE FASTENED BY FOUR-5/16" DIA. GALVANIZED A449 BOLTS (SAE J429 GRADE 5) OR GALVANIZED A325 BOLTS.

3 1b. U - CHANNEL STEEL POST
(WITH SPLICE)

NOT TO SCALE

MICHIGAN DEPARTMENT OF TRANSPORTATION BUREAU OF HIGHWAYS DELIVERY STANDARD PLAN	PENDING	8/2006	WZD-100-A	SHEET 6 of 11
	FHWA APPROVAL DATE			
File:PW/Doc/RD/T&S/Typ/Dev/Sign MainTraf D/WZD-100-A Rev. 8/21/06 ECH				

NOTE: THE ORIGINAL SIGNED COPY IS KEPT ON FILE AT THE MICHIGAN DEPARTMENT OF TRANSPORTATION.

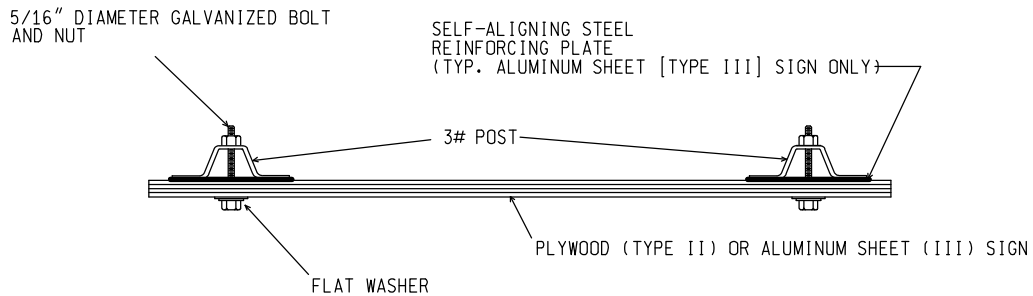

SIGN TO 3 lb. POST CONNECTION

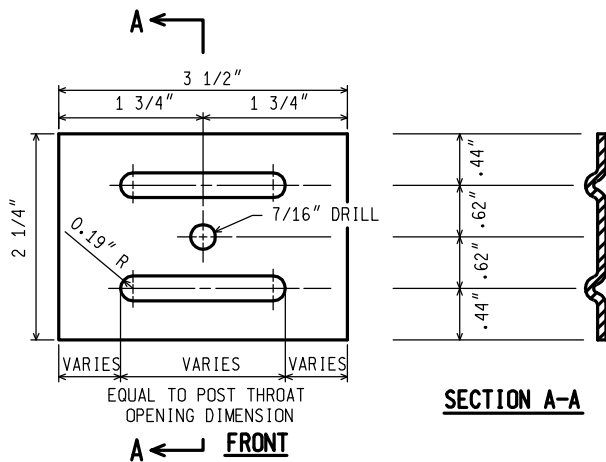

NOTES: (FOR STEEL SIGN REINF' PLATE)

1. MATERIAL: 12 GAUGE CARBON STEEL.
2. TOLERANCE ON ALL DIMENSIONS $\pm 0.0625"$
3. FINISH-AFTER STAMPING AND PUNCHING, GALVANIZE ACCORDING TO CURRENT SPECIFICATIONS FOR ZINC (HOT GALVANIZE) COATINGS ON PRODUCTS FABRICATED FROM PLATES OR STRIPS

STEEL SIGN REINFORCING PLATE
REQUIRED FOR TYPE III SIGNS ONLY

3 lb. U - CHANNEL STEEL POST SIGN CONNECTION

NOT TO SCALE

MICHIGAN DEPARTMENT OF TRANSPORTATION BUREAU OF HIGHWAYS DELIVERY STANDARD PLAN	PENDING FHWA APPROVAL DATE	8/2006	WZD-100-A	SHEET 7 of 11
File:PW/Doc/RD/T&S/Typ/Dev/Sign MainTraf D/WZD-100-A Rev. 8/21/06 ECH		PLAN DATE		

NOTE: THE ORIGINAL SIGNED COPY IS KEPT ON FILE AT THE MICHIGAN DEPARTMENT OF TRANSPORTATION.

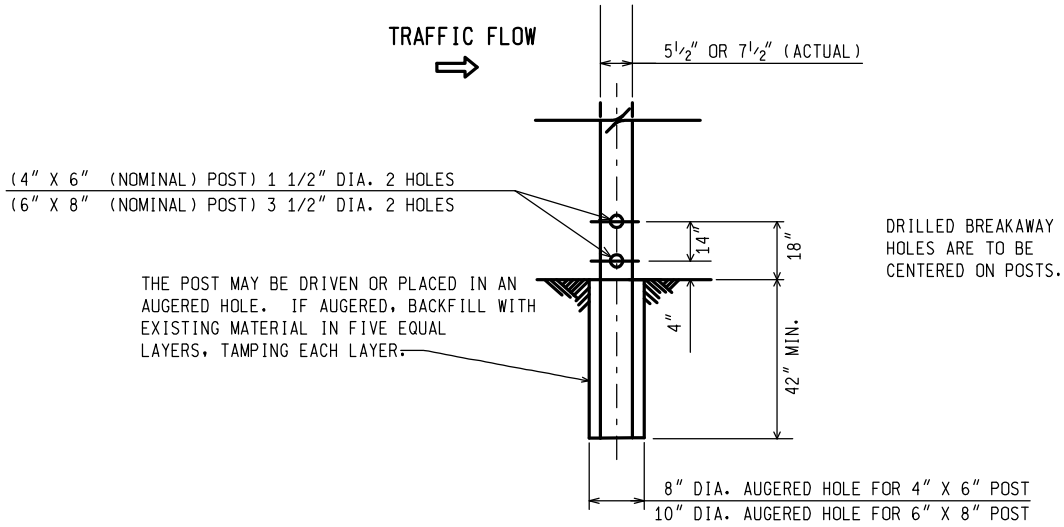

**WOOD POST BREAKAWAY HOLES/
 DIRECT EMBEDMENT DETAILS**

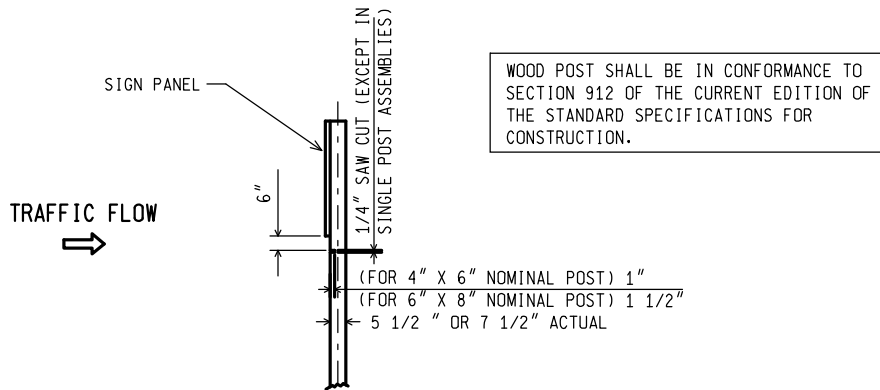

**SAW CUT DETAIL
 (MULTIPLE POST INSTALLATIONS)**

WOOD POST DETAILS

NOT TO SCALE

MICHIGAN DEPARTMENT OF TRANSPORTATION
 BUREAU OF HIGHWAYS DELIVERY STANDARD PLAN

PENDING
 FHWA APPROVAL DATE

8/2006
 PLAN DATE

WZD-100-A

SHEET
 8 of 11

File:PW/Doc/RD/T&S/Typ/Dev/Sign MainTraf D/WZD-100-A Rev. 8/21/06 ECH

NOTE: THE ORIGINAL SIGNED COPY IS KEPT ON FILE AT THE MICHIGAN DEPARTMENT OF TRANSPORTATION.

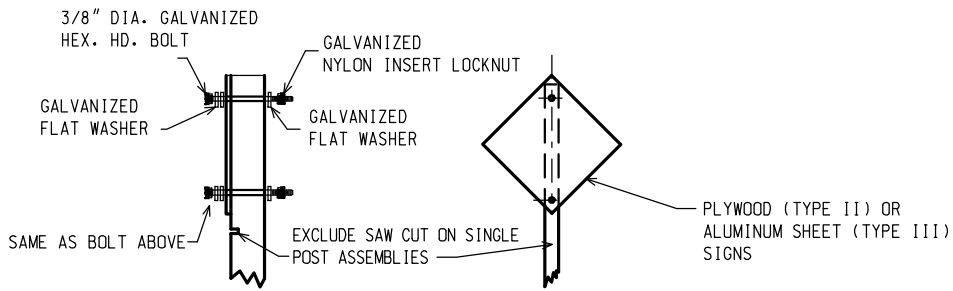

TYPE II AND TYPE III SIGNS

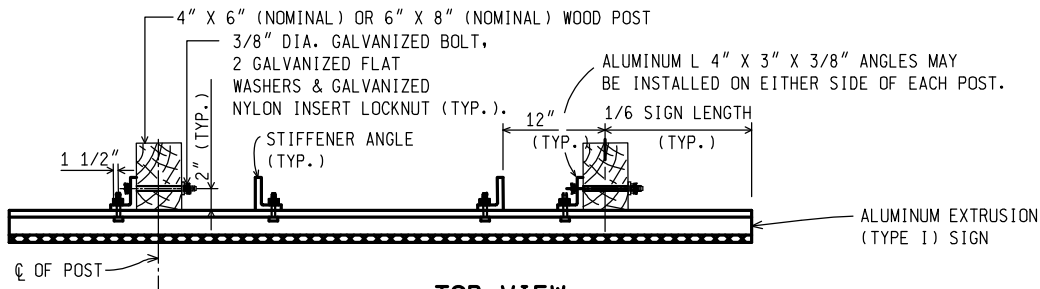

**TOP VIEW
TYPE I SIGN**

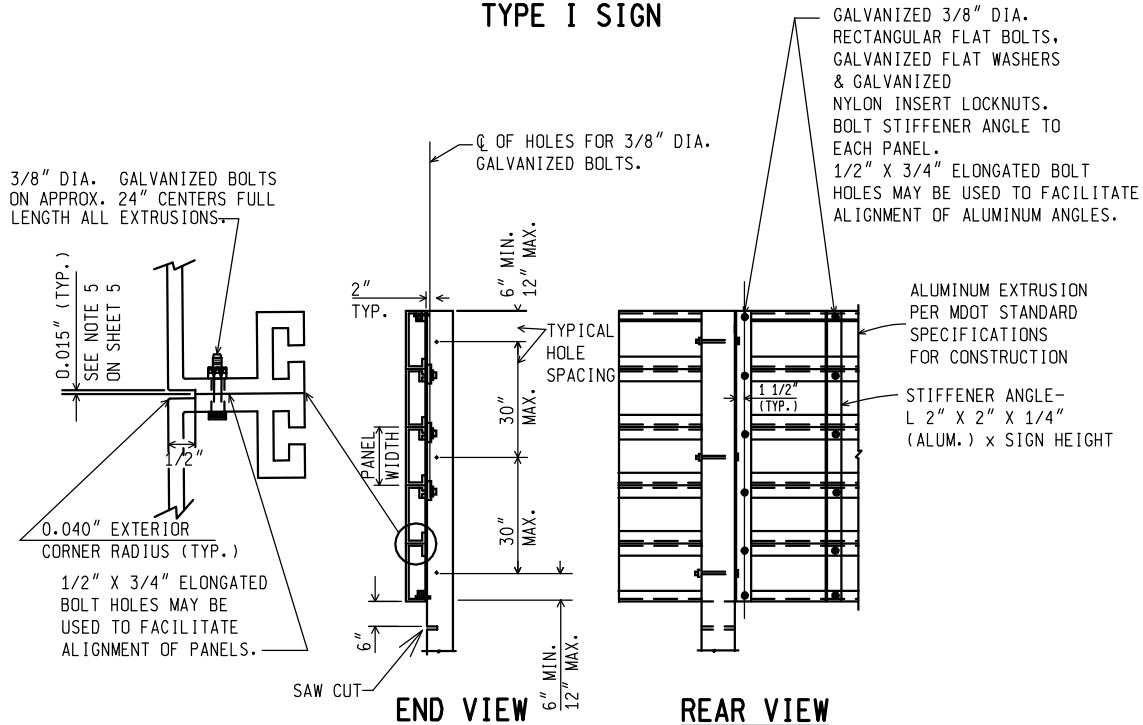

TYPE I SIGN - ERECTION DETAILS

WOOD POST CONNECTIONS

NOT TO SCALE

MICHIGAN DEPARTMENT OF TRANSPORTATION
BUREAU OF HIGHWAYS DELIVERY STANDARD PLAN

PENDING
FHWA APPROVAL DATE

8/2006

WZD-100-A

SHEET
9 of 11

File:PW/Doc/RD/T&S/Typ/Dev/Sign MainTraf D/WZD-100-A Rev. 8/21/06 ECH

PLAN DATE

NOTE: THE ORIGINAL SIGNED COPY IS KEPT ON FILE AT THE MICHIGAN DEPARTMENT OF TRANSPORTATION.

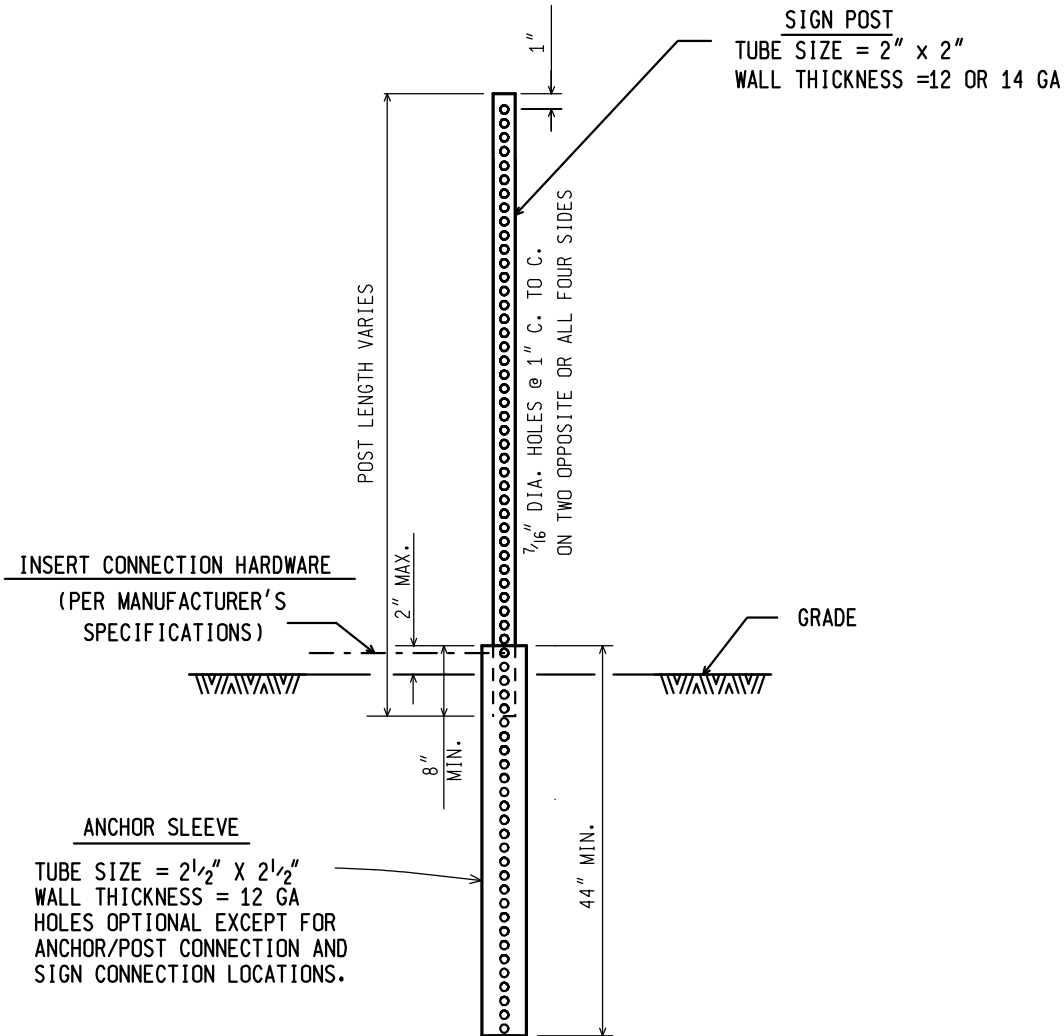

SQUARE TUBULAR STEEL POST

NOT TO SCALE

MICHIGAN DEPARTMENT OF TRANSPORTATION
 BUREAU OF HIGHWAYS DELIVERY STANDARD PLAN

PENDING
 FHWA APPROVAL DATE

8/2006
 PLAN DATE

WZD-100-A

SHEET
 10 of 11

File:PW/Doc/RD/T&S/Typ/Dev/Sign MainTraf D/WZD-100-A Rev. 8/21/06 ECH

NOTE: THE ORIGINAL SIGNED COPY IS KEPT ON FILE AT THE MICHIGAN DEPARTMENT OF TRANSPORTATION.

GENERAL NOTES:

1. A MAXIMUM OF TWO POSTS WITHIN A 7 FOOT PATH IS PERMITTED.
2. ALL SIGN POSTS SHALL COMPLY WITH NCHRP 350.
3. ALL POSTS SHALL BE EMBEDDED A MINIMUM OF 42".
4. BRACING OF POST IS NOT PERMITTED.
5. SIGN SHALL BE LEVEL, AND UPRIGHT FOR THE DURATION OF INSTALLATION.
6. ERECT POSTS SO THE SIGN FACE AND SUPPORTS DO NOT VARY FROM PLUMB BY MORE THAN 3/16" IN 3'. PROVIDE A CENTER-TO-CENTER DISTANCE BETWEEN POSTS WITHIN 2 PERCENT OF PLAN DISTANCE.
7. NO MORE THAN ONE SPLICE PER POST, AS SHOWN, WILL BE PERMITTED.
8. POST TYPES SHALL NOT BE MIXED WITHIN A SIGN SUPPORT INSTALLATION.
9. NO VERTICAL JOINTS ARE PERMITTED IN SIGN. NO HORIZONTAL JOINTS THROUGH SIGN LEGEND OR SYMBOLS ARE PERMITTED IN SIGN
10. REMOVE SIGN POSTS AND/OR POST STUBS IN THEIR ENTIRETY WHEN NO LONGER REQUIRED.
11. ALL LABOR, MATERIALS, AND EQUIPMENT, INCLUDING TEMPORARY SUPPORTS REQUIRED TO INSTALL, MAINTAIN, RELOCATE, COVER, AND/OR REMOVE THE TEMPORARY SIGN, INCLUDING SUPPORTS, ARE CONSIDERED TO BE INCLUDED IN THE COST OF THE TEMPORARY SIGN.
12. SAW CUTS IN WOOD POSTS ARE TO BE PARALLEL TO THE BOTTOM OF THE SIGN.
13. POSTS SHALL NOT EXTEND MORE THAN 4" ABOVE TOP OF SIGN.

NOT TO SCALE

MICHIGAN DEPARTMENT OF TRANSPORTATION BUREAU OF HIGHWAYS DELIVERY STANDARD PLAN	PENDING FHWA APPROVAL DATE	8/2006 PLAN DATE	WZD-100-A	SHEET 11 of 11
File:PW/Doc/RD/T&S/Typ/Dev/Sign MainTraf D/WZD-100-A Rev. 8/21/06 ECH				

NOTE: THE ORIGINAL SIGNED COPY IS KEPT ON FILE AT THE MICHIGAN DEPARTMENT OF TRANSPORTATION.

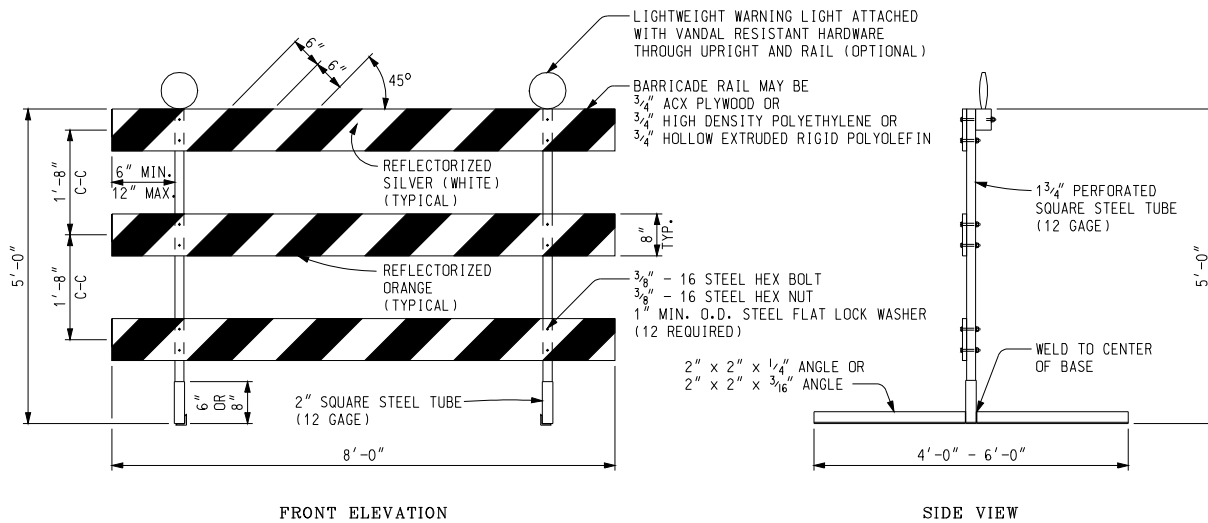

PERFORATED SQUARE STEEL TUBE OPTION

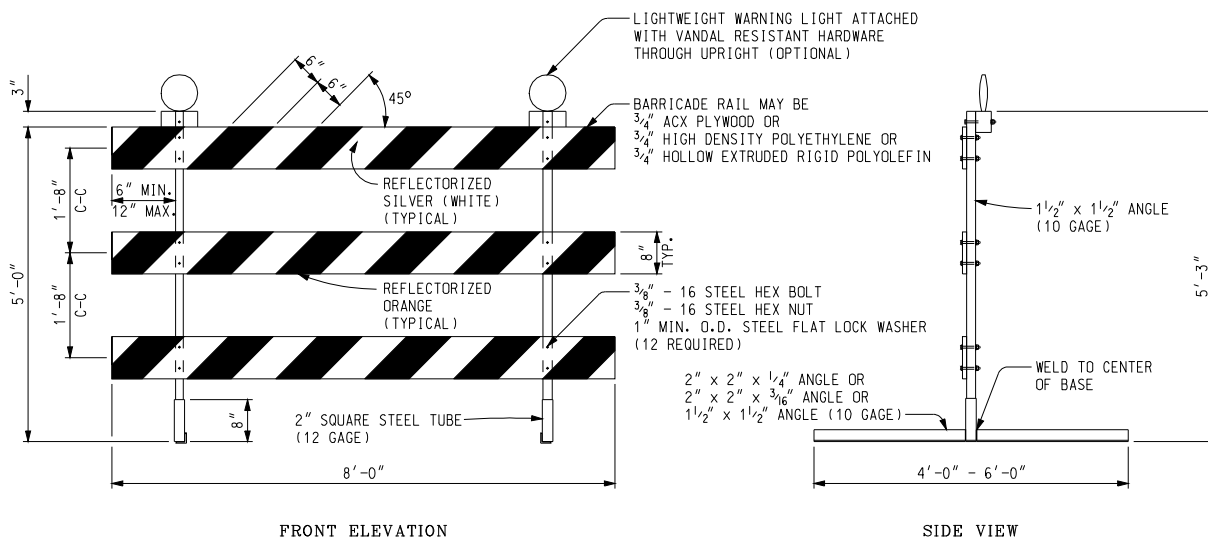

ANGLE IRON OPTION

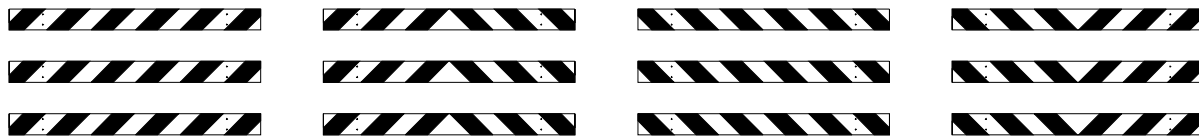

LEFT DIRECTIONAL

BI-DIRECTIONAL

RIGHT DIRECTIONAL

CLOSURES

BARRICADE RAIL SHEETING OPTIONS
TYPE III BARRICADES

Other Type III Barricades meeting current NCHRP crash worthy criteria can be found on the FHWA Safety website at

http://safety.fhwa.dot.gov/roadway_dept/road_hardware/wzd.htm

NOT TO SCALE

File: T&S/Typ/Signs/WorkZones/wzd 125 d

Rev. 09/22/09 PJ



PREPARED BY
TRAFFIC AND SAFETY

ENGINEER OF DELIVERY

ENGINEER OF DEVELOPMENT

(SPECIAL DETAIL)

FHWA APPROVAL DATE

MICHIGAN DEPARTMENT OF TRANSPORTATION
BUREAU OF HIGHWAYS DELIVERY STANDARD PLAN FOR

Temporary
Traffic Control Devices

9/22/09
PLAN DATE

WZD-125-E

SHEET
1 of 3

NOTE: THE ORIGINAL SIGNED COPY IS KEPT ON FILE AT THE MICHIGAN DEPARTMENT OF TRANSPORTATION.

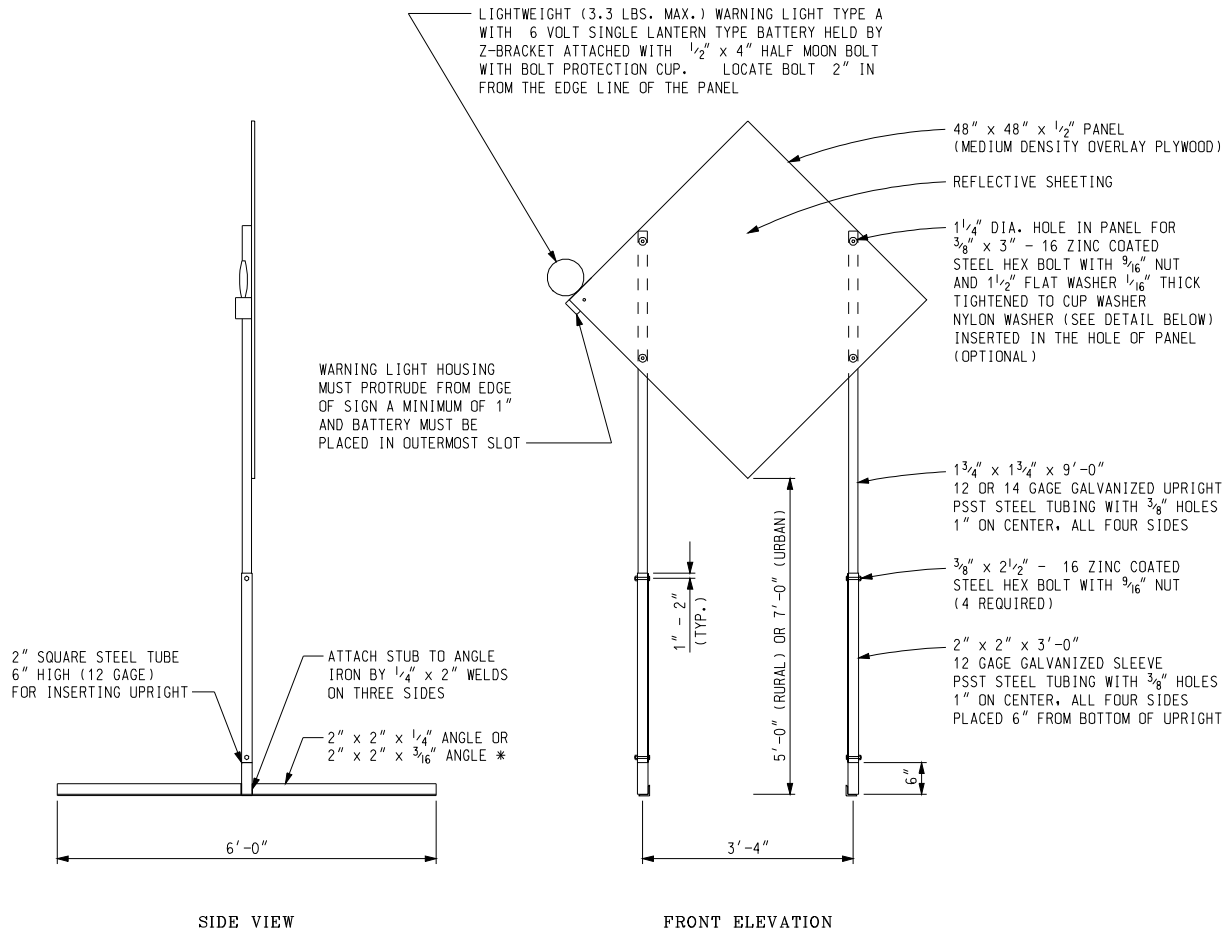

TEMPORARY SIGN SUPPORT

(WARNING LIGHT PLACED ON SIDE CLOSEST TO TRAFFIC)

- * SIGN STAND IS BALLASTED WITH FOUR OR MORE 35 LB SANDBAGS. A MINIMUM OF ONE ON EACH END.
- UPRIGHTS SHALL NOT EXTEND ABOVE THE SIGN PANEL.

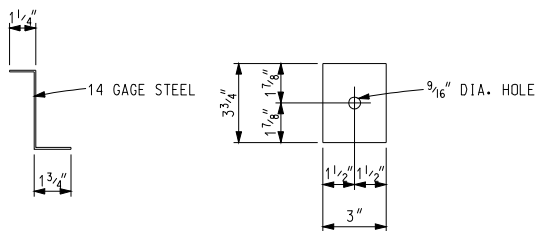

Z-BRACKET DETAIL

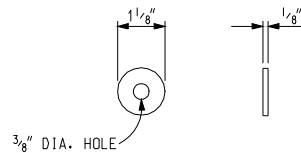

OPTIONAL NYLON WASHER

Other temporary sign supports meeting current NCHRP crash worthy criteria can be found on the FHWA Safety website at http://safety.fhwa.dot.gov/roadway_dept/road_hardware/wzd.htm

NOT TO SCALE

MICHIGAN DEPARTMENT OF TRANSPORTATION
BUREAU OF HIGHWAYS DELIVERY STANDARD PLAN

(SPECIAL DETAIL)
FHWA APPROVAL DATE

9/22/09
PLAN DATE

WZD-125-E

SHEET
2 of 3

NOTE: THE ORIGINAL SIGNED COPY IS KEPT ON FILE AT THE MICHIGAN DEPARTMENT OF TRANSPORTATION.

- PLASTIC DRUM
- ▲▲▲ PROPOSED TYPE III BARRICADE
- △△△ EXISTING TYPE III BARRICADE

SYMBOLS TO BE USED ON PLANS

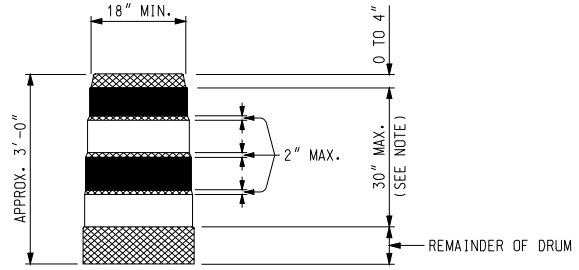

- REFLECTORIZED ORANGE
- REFLECTORIZED WHITE
- NON REFLECTORIZED ORANGE

NOTE:
 DRUMS SHALL HAVE AT LEAST 4 HORIZONTAL REFLECTORIZED STRIPES (2 ORANGE AND 2 WHITE) OF 6" UNIFORM WIDTH, ALTERNATING IN COLOR WITH THE TOPMOST REFLECTORIZED STRIPE BEING ORANGE. NON REFLECTORIZED SPACES BETWEEN THE HORIZONTAL REFLECTORIZED ORANGE AND WHITE STRIPES SHALL BE ORANGE IN COLOR AND EQUAL IN WIDTH.

PLASTIC DRUM

NOTES:

2" PERFORATED SQUARE STEEL TUBES MAY BE USED TO FABRICATE THE HORIZONTAL BASE OF THE TYPE III BARRICADE.

WARNING LIGHTS SHALL BE PLACED ACCORDING TO THE CURRENT STANDARD SPECIFICATIONS FOR CONSTRUCTION AND ALL OTHER PROVISIONS IN THE CONTRACT WHEN THEY ARE USED ON TYPE III BARRICADES.

SEE ROAD STANDARD PLANS R-113-SERIES FOR TEMPORARY CROSSOVERS FOR DIVIDED ROADWAY, AND R-126-SERIES FOR TYPICAL LOCATION AND SPACING OF PLASTIC DRUMS FOR PLACEMENT OF TEMPORARY CONCRETE BARRIER.

SIGNS, BARRICADES, AND PLASTIC DRUMS SHALL BE FACED WITH PRESSURE-SENSITIVE REFLECTIVE SHEETING ACCORDING TO THE CURRENT STANDARD SPECIFICATIONS FOR CONSTRUCTION.

SANDBAGS SHALL BE USED WHEN SUPPLEMENTAL WEIGHTS ARE REQUIRED TO ACHIEVE STABILITY OF THE BARRICADE. THE SANDBAGS SHALL BE PLACED SO THEY WILL NOT COVER OR OBSTRUCT ANY REFLECTIVE PORTION OF THE TRAFFIC CONTROL DEVICE.

NOT TO SCALE

MICHIGAN DEPARTMENT OF TRANSPORTATION BUREAU OF HIGHWAYS DELIVERY STANDARD PLAN	(SPECIAL DETAIL) FHWA APPROVAL DATE	9/22/09	WZD-125-E	SHEET 3 of 3
File: T&S/Typ/Signs/WorkZones/wzd 125 d	Rev. 09/22/09 PJ	PLAN DATE		

NOTE: THE ORIGINAL SIGNED COPY IS KEPT ON FILE AT THE MICHIGAN DEPARTMENT OF TRANSPORTATION.

CITY OF ANN ARBOR
DETAILED SPECIFICATION
FOR
MINOR TRAFFIC CONTROL

AA:DAD

1 of 4

03/15/16

a. Description. This work shall consist of protecting and maintaining vehicular and pedestrian traffic, in accordance with the City of Ann Arbor Standard Specifications for Construction sections 104.11 and 812 of the Michigan Department of Transportation (MDOT) 2012 Standard Specifications for Construction; Part 6 of the 2011 Edition of the Michigan Manual of Uniform Traffic Control Devices (MMUTCD); and, except as modified herein.

The work shall include, but is not limited to the following:

- The furnishing and operating of miscellaneous signs, warning devices, flags, and cones;
- The operation of additional signs furnished by the City;
- Furnishing and installing meter bags;
- Coordinating with the City to have meter heads removed and reinstalled;
- Maintaining pedestrian traffic;
- Temporarily covering traffic controls;
- Temporarily covering existing signs as directed;
- Any and all other miscellaneous and/or incidental items which are necessary to properly perform the work.

b. Materials. Materials and equipment shall meet the requirements specified in section 812 of the MDOT 2012 Standard Specifications for Construction.

c. Construction. The Contractor shall maintain pedestrian traffic at all times. For maintaining normal pedestrian traffic while performing sidewalk and driveway repair, Plastic Drum, High Intensity, Lighted shall be placed by the Contractor as directed by the Engineer. The Contractor, when directed by the Engineer, shall place "Sidewalk Closed" and/or "Cross Here" signs and the cost shall be included in this pay item and will not be paid for separately.

All temporary traffic/pedestrian control devices furnished by the Contractor shall remain the property of the Contractor. The City shall not be responsible for stolen or damaged signs, barricades, barricade lights or other traffic maintenance items. The Contractor shall replace missing traffic control devices immediately, at no additional cost to the Contractor or City. All existing signs, and signs erected by the City of Ann Arbor on this project shall be preserved, protected, and maintained by the Contractor. The City will repair any existing City owned signs, at the Contractor's expense, which are damaged by the Contractor during the work.

The Contractor shall temporarily cover conflicting traffic and/or parking signs when directed by the Engineer.

Parking violation citations issued to the Contractor, subcontractor, and material suppliers including each of their respective employees shall be enforced under appropriate City Code.

The work shall include: furnishing and operating of miscellaneous signs and warning devices; furnishing cones; operating additional signs furnished by the City throughout the life of the Contract; furnishing and operating pedestrian traffic control devices; maintaining a safe trench during all non-working hours; maintaining access to all drives; covering conflicting existing signs and removal of these covers; and any and all other miscellaneous and/or incidental items which are necessary to properly perform the work.

Where there is metered parking, the Contractor shall either rent and install meter bags, or, with the Engineer's authorization, coordinate with the City Field Operation Services to have meter heads removed and reinstalled.

The Contractor shall maintain vehicular and pedestrian traffic during the work by the use of traffic regulators, channelizing devices and signs as necessary, as directed by the Engineer, and in accordance with 2011 Edition of the MMUTCD. Typical applications for maintaining pedestrian traffic in accordance with the 2011 Edition of the MMUTCD are included in this detailed specification.

In order to maintain areas of on-street parking available for residents, the Engineer may direct the contractor to cover and uncover temporary "No Parking" signs within the project limits multiple times throughout the course of the project. Such repeated covering and uncovering of signs shall be included in this item of work and shall not be paid for separately.

d. Measurement and Payment. The completed work, as described, will be measured and paid for at the contract unit price for the following pay item:

<u>Pay Item</u>	<u>Pay Unit</u>
Minor Traffic Control, Max \$_____	Lump Sum

The unit price for this item of work shall include all labor, material, and equipment costs to perform all the work described by this Detailed Specification.

Costs for transporting barricades and other temporary traffic control devices shall be included in the bid prices for the individual items of work.

This item will be paid for on a pro rata basis with each progress payment. Measurement will be based on the ratio between work completed during the payment period and the total contract amount. When all of the work of this Contract has been completed, the measurement of this item shall be 1.0 Lump Sum minus any deductions incurred for inadequate performance as described herein. This amount will not be increased for any reason, including extensions of time, extras, and/or additional work.



Figure 6H-28. Sidewalk Detour or Diversion (TA-28)

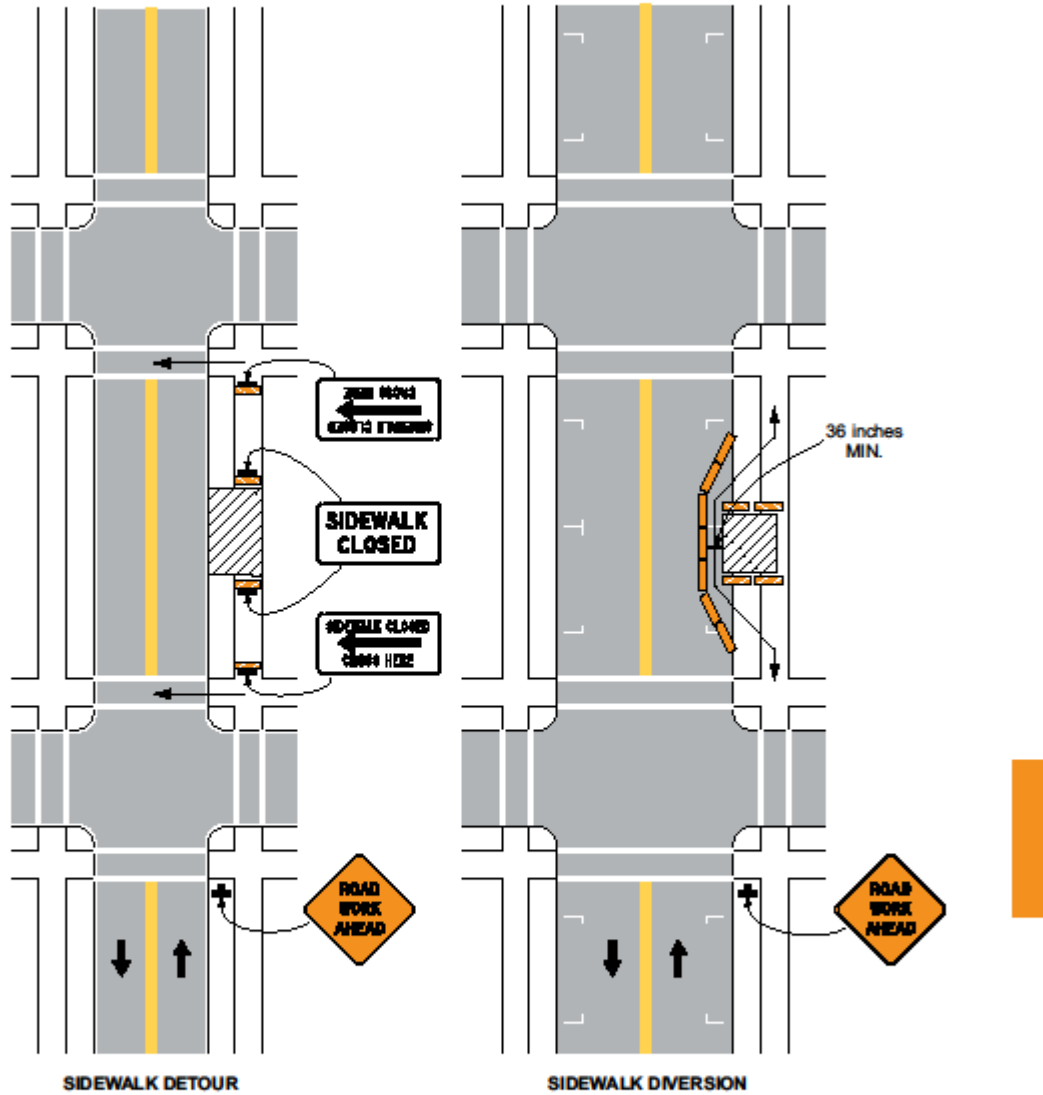

Typical Application 28

Note: See Tables 6H-2 and 6H-3 for the meaning of the symbols and/or letter codes used in this figure.

Figure 6H-29. Crosswalk Closures and Pedestrian Detours (TA-29)

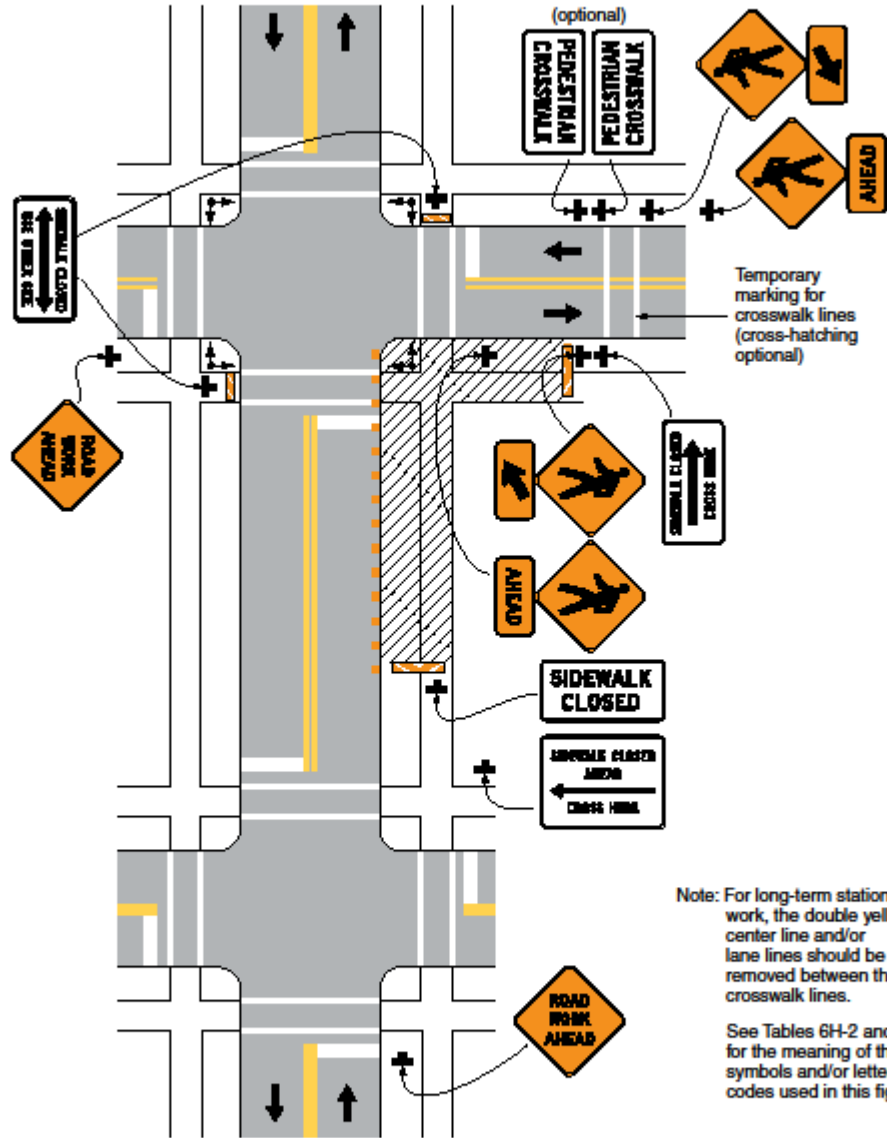

Note: For long-term stationary work, the double yellow center line and/or lane lines should be removed between the crosswalk lines.

See Tables 6H-2 and 6H-3 for the meaning of the symbols and/or letter codes used in this figure.

Typical Application 29

CITY OF ANN ARBOR
DETAILED SPECIFICATION
FOR
NO PARKING SIGNS

AA:DAD

1 of 1

04/05/15

a. Description. This work shall consist of installing, maintaining and removing of "No Parking" signs and posts as outlined herein and as referenced on the plans. "No Parking" signs shall be installed in accordance with the section 812 of the Michigan Department of Transportation (MDOT) 2012 Standard Specifications for Construction Standard Specifications and the 2011 Michigan Manual of Uniform Traffic Control Devices (MMUTCD).

b. Materials. The City will furnish "No Parking" signs to the Contractor at no cost. The Contractor shall furnish the sign support and mounting hardware materials, which materials shall be in accordance with those specified in section 919 of the MDOT 2012 Standard Specifications for Construction.

c. Construction. Prior to the commencement of any construction activity, the Contractor shall place "No Parking" signs as directed by the Engineer. The Contractor shall obtain a permit for "Temporary Permission of Reserve Parking Lane for Work Related Purposes" from the City's Project Management Services Unit. This permit shall be obtained a minimum of 5 business days prior to the posting of "No Parking" signs.

The Contractor shall securely bolt the signs to the sign supports as directed by the Engineer. The Contractor shall imbed the sign supports at least two feet into the ground, and there shall be a minimum of six feet and maximum of seven feet of clearance maintained between the bottom of the sign and the ground. The signs are to be placed at intervals no more than 75 feet, and as necessary to eliminate parking in the construction area.

The installation of "No Parking" signs shall be in accordance with the permit. "No Parking" signs shall be installed by the Contractor, as directed by the Engineer, at least 48 hours prior to the proposed start-of-work/enforcement date. "No Parking" signs shall be covered by the Contractor, thereby allowing on-street parking, until between 48 and 24 hours prior to the start of the work. "No Parking" signs shall be covered by the Contractor whenever there is no work being performed for a period of time longer than 72 hours. "No Parking" signs shall be returned to the City upon the completion of work. The cost of unreturned signs will be back charged to the Contractor.

d. Measurement and Payment. The completed work, as described, will be measured and paid for at the contract unit price for the following pay item:

<u>Pay Item</u>	<u>Pay Unit</u>
No Parking Sign	Each

The item **No Parking Sign** will be measured as the maximum number of signs installed on the project at any one time. The unit price includes the removal and return of "No Parking" signs to the City upon completion of the project. The Contractor shall be back charged for the replacement costs for damaged or unreturned signs.

CITY OF ANN ARBOR
DETAILED SPECIFICATION
FOR
PROTECTING AND PRESERVING IRRIGATION SYSTEMS

AA:DAD

1 of 1

03/15/16

a. Description. This work shall consist of all labor, materials, and equipment necessary to investigate, locate, save and protect from damage, ensure continued and proper operation during the performance of the project work, re-establish operation as necessary, and upon completion of all project work, ensure that all existing sprinkler systems located within the project limits, or those affected by the project, are functioning in a satisfactory manner as determined by the Engineer.

b. Materials. None specified.

c. Construction. The Contractor shall be aware that properties located within the project limits have underground sprinkler systems that irrigate both private property and portions of the public right-of-way. The irrigation systems have been installed by a variety of private installers and may utilize several different materials and/or suppliers of the various components. Portions of the existing irrigation systems have been installed under paved areas, extend into landscaped islands, or may be required to be located within such areas at the conclusion of the project's construction.

The contractor shall perform the necessary investigations to determine the precise location of the irrigation systems, and all affected components, prior to the commencement of construction operations, determine all impacts to the systems that will result pursuant to the project's construction, and take the needed actions to ensure that the sprinkler systems will remain functional during the project's construction, and will be re-established in such a manner at appropriate intermediate and final project milestones, that the original functionality of the system is maintained to the greatest extent possible.

The Contractor shall contact all property owners prior to the commencement of the work in order to determine the impacts to their irrigation systems and coordinate the project's work with them to ensure satisfactory operation of the irrigation systems during construction.

All work shall be approved by the Engineer and the affected property owner(s) at the conclusion of the project's work.

d. Measurement and Payment. The completed work, as described, will be measured and paid for at the contract unit price for the following pay item:

<u>Contract Item (Pay Item)</u>	<u>Pay Unit</u>
Irrigation System, Protection and Maintenance	Dollar

The unit price for this item shall include all labor, material, and equipment costs required to complete the work.

CITY OF ANN ARBOR
DETAILED SPECIFICATION
FOR
SLOPE RESTORATION

AA:DAD

1 of 2

04/05/15

a. Description. This work consists of preparing all manicured lawns and slopes on non-freeway projects designated for slope restoration on the plans or by the Engineer, and applying topsoil, fertilizer, seed, and mulch to those areas. Turf establishment shall be in accordance with section 816 of the Michigan Department of Transportation (MDOT) 2012 Standard Specifications for Construction and Standard Plan Series R-100, except as modified herein or otherwise directed by the Engineer.

b. Materials. The materials and application rates specified in sections 816 and 917 of the MDOT 2012 Standard Specifications for Construction apply unless modified by this special provision or otherwise directed by the Engineer.

1. Topsoil Surface: Place **4 inches** of topsoil in area disturbed areas to be restored. Topsoil shall be free of all stones one inch in diameter or greater.
2. Turf Seed Mixture: Use seed mixture type THM (Turf Loamy to Heavy).
3. Chemical Fertilizer Nutrient: Use Class A fertilizer.
4. Use Mulch Blankets on all areas to be restored.

c. Construction. Construction methods shall be in accordance to subsection 816.03 of the MDOT 2012 Standard Specifications for Construction. Begin this work as soon as possible after final grading of the areas designated for slope restoration but no later than the maximum time frames stated in subsection 208.03 of the Standard Specifications for Construction. It may be necessary, as directed by the Engineer, to place materials by hand.

Prior to placing topsoil, shape, compact and assure all areas to be seeded **are weed free**. Place topsoil to the minimum depth indicated above, to meet proposed finished grade. Remove any stones greater than or equal to 1 inch in diameter. If the area being restored requires more than the minimum depth of topsoil to meet finished grade, this additional depth must be filled using topsoil. Furnishing and placing this additional material is included in this item of work.

Topsoil shall be **weed and weed seed free** and friable prior to placing seed. Remove all stones from the topsoil greater than 1 inch in diameter. Apply seed mixture and fertilizer to prepared soil surface. Seed shall be incorporated into top ½ inch of topsoil.

If an area washes out after this work has been properly completed and approved by the Engineer, make the required corrections to prevent future washouts and replace the topsoil, fertilizer, seed and mulch. This replacement will be paid for as additional work using the applicable contract items.

If an area washes out for reasons attributable to the Contractor's activity or failure to take proper precautions, replacement shall be at the Contractor's expense.

The Engineer will inspect the seeded turf to ensure the end product is well established, weed free, in a vigorous growing condition, and contains the species called for in the seeding mixture. **If areas do not promote growth, the Contractor shall apply new seed at its expense.**

If weeds are determined by the Engineer to cover more than ten percent of the total area of slope restoration, the Contractor shall provide weed control in accordance to subsection 816.03.J of the MDOT 2012 Standard Specifications for Construction. Weed control shall be at the Contractor's expense with no additional charges to the project for materials, labor or equipment.

d. Measurement and Payment. The completed work, as described, will be measured and paid for at the contract unit price for the following pay item:

<u>Pay Item</u>	<u>Pay Unit</u>
Slope Restoration	Square Yard

Slope Restoration shall be performed in all areas disturbed by the Contractor to construct the Project as shown on the plans and as directed by the Engineer. The Contractor will restore areas disturbed by its operations not required by the Project at its own expense.

CITY OF ANN ARBOR
DETAILED SPECIFICATION
FOR
ELECTRICAL AND COMMUNICATION HANDHOLES

AA:DAD

1 of 2

03/15/16

a. Description. This work shall consist of furnishing and installing traffic signal handholes and communication handhole assemblies at the locations shown in the Plans, or as directed by the Engineer. All work shall be completed in accordance with the current National Electric Code (NEC), section 819 of the Michigan Department of Transportation (MDOT) 2012 Standard Specifications for Construction, except as specified herein.

b. Materials. All materials shall be new and meet the requirements of the current IEEE, NEMA, ANSI Standards as applicable, and as specified herein.

The Contractor shall submit product data sheets for all handholes, covers and other parts for Engineer approval prior to ordering materials. The manufacturer "Quazite Composites," referenced below, is located in Lenoir City, Tennessee.

12 inch x 18 inch handhole assemblies shall consist of "Quazite Composites" box. The box shall be #PG1118BA12. The cover shall be, #PG1118HA41, a locking heavy-duty bolt-down type with a logo that reads "Street Lighting." The total depth of the handhole shall be 12 inches.

17 inch x 30 inch handhole assemblies shall consist of two, stacked "Quazite Composites" boxes. The lower box shall be #PG1730BB18. The upper box shall be #PG1730BA18. The cover shall be, #PG1730HA46, a locking heavy-duty bolt-down type with a logo that reads "Traffic Signal." The total depth of the handhole shall be 36 inches.

24 inch x 36 inch handhole assemblies shall consist of "Quazite Composites" box. The box shall be #PG2436BA24. The cover shall be, #PG2436HA12, a locking heavy-duty bolt-down type with a logo that reads "Street Lighting." The total depth of the handhole shall be 24 inches.

Provide Granular Material, CI II in accordance with section 902 of the MDOT 2012 Standard Specifications for Construction.

c. Construction. Handholes shall be placed at all junctions of traffic signal or electrical conduit, and as shown on the plans. Maximum distance between any two handholes shall be as shown on the Plans, but in no case shall exceed 500 feet.

Place foundation material consisting of four (4) inches of Granular Material, CI II compacted to 95% of its maximum unit weight.

Set the handhole or stacked units to the proper depth and elevation.

Connect handholes to new and existing conduits, whether shown on the plans or not. All conduits shall be connected to the handholes in accordance with the latest revision of Article 346 of the National Electrical Code (NEC).

Backfill around the perimeter of the handhole with Granular Material, CI II compacted to 95% of its maximum unit weight.

d. Measurement and Payment. The completed work, as described, will be measured and paid for at the contract unit prices for the following pay items:

<u>Pay Item</u>	<u>Pay Unit</u>
Handhole Assembly, 12 inch x 18 inch.....	Each
Handhole Assembly, 17 inch x 30 inch.....	Each
Handhole Assembly, 24 inch x 36 inch.....	Each

Handhole Assembly, ___ inch x ___ inch shall be paid for at their contract unit prices and shall include all labor, equipment, and materials to complete the work as specified herein.

The pay item shall also include the excavation and disposal of materials, furnishing, installing and compacting Granular Material, CI II, and all work related to connecting handholes to new and existing conduits, whether shown or not shown on the plans.

CITY OF ANN ARBOR
DETAILED SPECIFICATION
FOR
PARKING METERS

AA:DAD

1 of 2

03/27/17

a. Description. This work shall consist of removing parking meter standards and installing new meter standards where directed.

b. Materials. Republic Parking will supply all standards. Standards are steel tubes 60" to 63" in length and 2" square.

All sand shall meet the gradation of MDOT Class II granular material in accordance with Section 902 of the 2012 MDOT Standard Specifications for Construction.

Concrete shall be Grade P2 in accordance with Section 601 of the MDOT 2012 Standard Specifications for Construction.

c. Construction.

1. Removal. Meter standards requiring removal will be marked by the City. Prior to removal, contact Republic Parking at (734) 761-7235 for the removal of the parking meter heads. The Contractor is not permitted to remove the meter heads, nor remove the standard with the meter head still in place.

The Contractor shall removal the standard and concrete foundation. The void is to be backfilled with Class II Granular Material or Engineer approved backfill. The standards and concrete will then become of the property of the Contractor and shall be properly disposed of offsite.

2. Installation. The City will stake the location for the new meter locations. The location is approximately 18" to 24" from curb line, and 48" from front end of stall for parallel parking.

A. Installation in sidewalk/concrete. Core an 8" diameter hole through the concrete sidewalk at the meter location points. When working in close proximity of underground lines, use caution to avoid drilling beyond the thickness of the sidewalk in order to prevent damage to lines. For installation in new sidewalk, the standard may be installed prior to placing walk, or the walk may be placed around a form in the location of the proposed standard.

After drilling through the sidewalk, excavate approximately 30" deep, with an 8" diameter opening, and tapering outward to 10" at the bottom.

Set the standards into the concrete filled holes with the REAMED END to the TOP and WEEP HOLE on LOWER END FACING THE STREET. The meter standard is to project 37" above the sidewalk level.

Check the vertical plumb with the surface level, first in one direction and then in the other and then hold the standard securely in position with forms until the concrete has set.

After the standards have been plumbed, check the vertical alignment down the street and the height uniformity, making such corrections and adjustments as necessary.

CITY OF ANN ARBOR
DETAILED SPECIFICATION
FOR
PARKING METERS

AA:DAD

2 of 2

03/27/17

B. Installation in soil. Excavate holes approximately 30” deep, with an 8” diameter opening, and tapering outward to 10” at the bottom.

Set the standards into the concrete filled holes with the REAMED END to the TOP and WEEP HOLE on LOWER END FACING THE STREET. The meter standard is to project 37” above the finished grade.

Check the vertical plumb with the surface level, first in one direction and then in the other and then hold the standard securely in position with forms until the concrete has set.

After the standards have been plumbed, check the vertical alignment down the street and the height uniformity, making such corrections and adjustments as necessary.

The Contractor is responsible for the protection of the standard until the concrete foundation has set. If the standard is not plumb upon curing of the foundation, then the standard will be removed and reset at the contractor’s expense. The Contractor shall use plastic drums and caution tape, “Wet Paint” signs, or other methods to protect the standards.

Meter heads will be installed by Republic Parking upon installation of the standards.

d. Measurement and Payment. The completed work, as described, will be measured and paid for at the contract unit prices for the following pay items:

<u>Pay Item</u>	<u>Pay Unit</u>
Remove Parking Meters.....	Each
Install Parking Meters.....	Each

Remove Parking Meters and **Install Parking Meters** will be measured and paid for at the respective contract unit prices for each meter that is removed and each meter that is installed, which price shall be payment in full for all labor, equipment and material needed to accomplish this work.

Disposal of standards, concrete foundations, and all excavated material is included in each respective unit price for the above items.

Material to backfill voids after removing the standards is included in the pay item “Remove Parking Meters”.

APPENDIX

- Notices to Bidders
- Michigan Department of Transportation (MDOT) Special Provisions
 - MDOT Supplemental Specifications
 - Geotechnical Information

CITY OF ANN ARBOR

NOTICE TO BIDDERS

AA:DAD

1 of 2

03/04/17

Utilities Coordination

The Contractor shall cooperate and coordinate construction activities with the owners of utilities as stated in subsection 104.08 of the Standard Specifications for Construction. In addition, for the protection of underground utilities, the Contractor shall follow the requirements in subsection 107.12 of the Standard Specifications for Construction. Contractor delay claims resulting from a utility will be determined based upon subsection 108.09 of the Standard Specifications for Construction.

The following Utility Owners, together with others, may have facilities located within the Right-of-Way:

<u>Utility</u>	<u>Type of Service</u>
City of Ann Arbor W.R. Wheeler Service Center 4251 Stone School Road Ann Arbor, MI 48108 734 794-6351	Sanitary Sewer (Pat Maino - ext. 43817) Water (Daniel Wooden - ext. 43324) Storm Sewer (Matthew Waldsmith - ext. 43321) Communications/Signs/Signals/Street Lighting (Chuck Fojtik - ext. 43322)
AT&T 550 South Maple Ann Arbor, MI 48103 Attn: Debora Renner 734-996-5485 debora.a.renner@att.com	Telephone/Fiber Optic
Comcast 27800 Franklin Road Southfield, MI 48034 Attn: Ron Southerland 248-359-6544 ronald_southerland@cable.comcast.com	Cable/Fiber Optic
DTE Energy 2000 2 nd Ave, Room 518 S.B. Detroit, MI 48226 Attn: Julie Gottardi 734-884-0585 gottardij@dteenergy.com	Electric
DTE Energy (Michcon) 17150 Allen Road Melvindale, MI 48122 Attn: Laurie Forrester 313-389-7261 forresterl@dteenergy.com	Gas

UtilityType of Service

MCI/Verizon
5688 W Grand River Avenue
Lansing, MI 48906
Attn: Rick Chalmers
517-318-8064
rick.chalmers@verizonbusiness.com

Telephone/Fiber Optic

For protection of underground utilities, the Contractor shall call "MISS DIG" toll free at 1-800-482-7171 or call 811 a minimum of three (3) working days prior to excavation within the project limits. The Contractor must also notify utility owners who may not be part of the "MISS DIG" system.

The Contractor shall notify the City of Ann Arbor a minimum of three (3) days prior to beginning construction.

The Owners of public or private utilities which will not interfere with the completed project and which do not present a hazard to the public or an extraordinary hazard to the Contractor's operations will not be required to move their facilities on or from the street right-of-way.

The Contractor shall verify the location and depth of all utilities through Miss Dig and coordinate with the utilities to ensure that all utilities are protected during the project.

Protection of existing utility facilities is necessary during the project. Protection may include: holding utility poles, supporting underground facilities, temporary sheeting, bracing, poles, cables, sand fill or other means to complete the work. The Contractor is responsible for furnishing all labor, equipment and materials required to protect existing facilities during construction. Costs associated with protecting existing utilities will not be paid for separately.

CITY OF ANN ARBOR

NOTICE TO BIDDERS

AA:JN

1 of 1

3/11/16

Parking Meter Removal and Covers

The proposed work and/or staging area will be along streets which contain parking meters for on-street parking. The Contractor shall coordinate directly with Republic Parking, telephone (734) 761-7235 for the removal of meter heads from standards requiring removal and for the provision of Parking Meter Covers (Meter Bags), which, when properly installed by the Contractor in a timely manner, will prohibit parking at metered parking spaces.

Parking Meter Covers

Meter Bags must be installed a minimum of 24-hours prior to the desired time of enforcement. Written documentation and/or visual inspection by City personnel may be required to adequately verify this requirement. The Parking Enforcement Office will be unable to enforce the desired "No-Parking Zone" unless the Contractor installs the Meter Bags in a proper and timely manner.

The Contractor has the sole responsibility for obtaining the Meter Bags from Republic Parking, placement, and maintenance. Delays due to on-street parking shall not be cause for any extra payments to the Contractor.

Information regarding obtaining the Meter Bags, and the temporary prohibition of on-street parking, is available from Republic Parking, telephone (734) 761-7235.

Republic Parking is waiving all Meter Bag rental fees for this project. The Contractor will be responsible for all costs associated with obtaining, installing, and maintaining the Meter Bags.

Parking Meter Removals

The project will require the removal and/or relocation of Parking Meters. The Contractor must contact Republic Parking at (734) 761-7235 at least three (3) days prior to removing the standards marked for removal. Republic Parking will remove the meter heads from the existing standards. The standards may not be removed until the meter heads have been removed by Republic Property. The Contractor may not remove the meter heads.

MICHIGAN
DEPARTMENT OF TRANSPORTATION

SPECIAL PROVISION
FOR
DEBRIS OR MATERIALS IN TRAFFIC LANES

CFS:BRZ

1 of 1

APPR:EMB:DAJ:01-10-08
FHWA:APPR:06-01-11

Delete Subsection 104.07.B.2 on page 36 of the Standard Specifications for Construction, in its entirety and replace it with the following:

- 2. Construction Safety Program.** Before beginning work on the project, the Contractor must submit a written "Construction Safety Program" that outlines the plan and procedures for preventing and mitigating accidents and fires on the project and meeting all health and safety requirements of the contract. Also in the program include provisions for meeting the requirements of subsection 812.03 and details for the materials and equipment that will be used to prevent construction related debris or materials from entering the open lanes of traffic and what actions, including traffic control measures, will be taken to immediately and safely remove the debris or material from the roadway. The Contractor must meet with the Engineer to discuss the "Construction Safety Program" and to develop mutual understandings to govern the administration and enforcement of the program.

Replace the second sentence in the first paragraph of Subsection 104.07.C.3 on page 37 of the Standard Specifications for Construction with the following:

The Contractor is responsible, at the Contractor's expense, to provide the necessary materials and equipment to prevent construction related debris or materials from entering the open lanes of traffic. This includes protection of traffic controls, removal of spilled materials or debris from the roadbed or drainage courses, and repair of damaged facilities necessary for public travel and safety.

MICHIGAN
DEPARTMENT OF TRANSPORTATION

SPECIAL PROVISION
FOR
HIGH VISIBILITY CLOTHING

SSA:JDG

1 of 1

APPR:MWB:CRB:06-18-14
FHWA:APPR:06-27-14

Add the following, to the end, of subsection 104.07.B, Safety and Health Requirements, on page 36 of the Standard Specification for Construction:

4. **Worker Visibility.** Effective November 24, 2008, all workers within the right-of-way who are exposed to traffic or to construction equipment within the work area, must wear high visibility clothing.

High visibility clothing or high visibility safety apparel is personal protective safety clothing that is intended to provide conspicuity during both daytime and nighttime usage. High Visibility safety apparel must meet the Performance Class 2 or 3 requirements of the American National Standards Institute/International Safety Equipment Association (ANSI/ISEA) 107-2004 for High-Visibility Safety Apparel and subsequent revisions thereof.

Costs incurred to comply with this requirement will be the responsibility of the Contractor.

MICHIGAN
DEPARTMENT OF TRANSPORTATION

SPECIAL PROVISION
FOR
CONSTRUCTION STAGING AREAS

DES:LFS

1 of 1

APPR:JJG:KAS:10-06-11
FHWA:APPR:10-11-11

Add the following subsection to section 107, on page 70 of the 2012 Standard Specifications for Construction:

107.22 Construction Staging Areas. The contractor must not use any public recreation area as a staging area, marshalling yard, storage facility, or for any other construction support unless it is defined in the contract.

Public recreation areas include: parks, trails, game areas, wildlife and waterfowl refuges, playgrounds, golf courses, athletic fields or similar areas which are publically owned by public school districts, local, state, or federal governments.

Any agreements negotiated between the Contractor and the owner of the public recreation area, before or after the award of the contract will not be considered valid by the Department.

If the Engineer determines the Contractor is in non-compliance with this subsection, penalties up to and including termination of the contract, in accordance with subsection 108.12, may be enacted as well as the immediate restoration of the public recreation area at the Contractor's cost.

MICHIGAN
DEPARTMENT OF TRANSPORTATION

SPECIAL PROVISION
FOR
EROSION CONTROL, INLET PROTECTION, FABRIC DROP

CFS:DMG

1 of 2

APPR:TWK:CP:08-29-16
FHWA:APPR:08-30-16

a. Description. This work consists of furnishing and installing acceptable alternatives to inlet protection devices (devices) listed in the *Soil Erosion and Sedimentation Control Manual* when the pay item Erosion Control, Inlet Protection, Fabric Drop is included in the contract.

This work consists of providing all labor, equipment and materials necessary to furnish, install, maintain, dispose of collected material and remove devices at the locations shown on the plans or as directed by the Engineer.

b. Materials. The following devices are approved for use as acceptable alternatives:

1. Siltsack Type B, Regular Flow, by ACF Environmental, Inc.
2. Inlet Pro Sediment Bag, Standard Flow, with optional foam deflector by Hanes Geo Components.
3. Dandy Curb Bag, Dandy Bag, Dandy Curb Sack, Dandy Sack, or Dandy Pop by Dandy Products, Inc.
4. Basin Bag, Regular Flow by CSI Geoturf.

Ensure provided devices are sized appropriately for the drainage structures in which they will be installed.

c. Construction. Install, maintain and remove the devices according to the manufacturer's guidelines. Remove material collected by the devices according to the manufacturer's guidelines or as directed by the Engineer.

Dispose of collected material in accordance with subsection 205.03.P of the Standard Specifications for Construction. Those devices that are no longer needed and have been removed may be reused elsewhere on the project as approved by the Engineer.

d. Measurement and Payment. The completed work, as described, will be measured and paid for at the contract unit price using the following pay item:

Pay Item	Pay Unit
Erosion Control, Inlet Protection, Fabric Drop.....	Each

Erosion Control, Inlet Protection, Fabric Drop will be paid for as one each for each time the alternate device listed herein is installed, maintained, and removed at a separate location within the project limits.

MICHIGAN
DEPARTMENT OF TRANSPORTATION

SPECIAL PROVISION
FOR
SAMPLING ASPHALT BINDER ON LOCAL AGENCY PROJECTS

CFS:MF

1 of 1

APPR:JAR:JTL:12-19-01
FHWA:CON. APPR:06-06-11

For informational purposes, original samples of asphalt binder will be taken by the Contractor and delivered to the Engineer prior to incorporation into the mixture. The frequency of sampling will be determined by the Engineer. The cost of obtaining and delivering the samples to the Engineer will be included in the hot mix asphalt (HMA) pay items.

The Contractor must certify in writing that the materials used in the HMA mixture are from the same source as the materials used in developing the HMA mixture design and the bond coat is from an approved supplier as stated in the *Material Quality Assurance Procedures Manual*.

MICHIGAN
DEPARTMENT OF TRANSPORTATION

SPECIAL PROVISION
FOR
RECYCLED HOT MIX ASPHALT MIXTURE ON LOCAL AGENCY PROJECTS

CFS:KPK

1 of 2

APPR:JWB:CJB:03-13-14
FHWA:APPR:03-13-14

Add the following subsection to subsection 501.02.A.2, on page 234 of the Standard Specifications for Construction.

- c. **Reclaimed Asphalt Pavement (RAP) and Binder Grade Selection.** The method for determining the binder grade in HMA mixtures incorporating RAP is divided into three categories designated Tier 1, Tier 2 and Tier 3. Each tier has a range of percentages that represent the contribution of the RAP binder toward the total binder, by weight. The tiers identified below apply to HMA mixtures with the following exception: Superpave mixture types E3, E3 High Stress, E10, E10 High Stress, E30, E30 High Stress, E50, and E50 High Stress used as leveling or top course must be limited to a maximum of 27 percent RAP binder by weight of the total binder in the mixture.

Recycled materials may be used as a substitute for a portion of the new materials required to produce HMA mixtures in accordance with contract.

- **Tier 1 (0% to 17% RAP binder by weight of the total binder in the mixture).** No binder grade adjustment is made to compensate for the stiffness of the asphalt binder in RAP.
- **Tier 2 (18% to 27% RAP binder by weight of the total binder in the mixture).** For all mixtures no binder grade change will occur in Tier 2 for all shoulder and temporary road mixtures.

The required asphalt binder grade must be at least one grade lower for the low temperature than the design binder grade required for the specified project mixture type. Lowering the high temperature of the binder one grade is optional. For example, if the design binder grade for the mixture type is PG 58-22, the required grade for the binder in the HMA mixture containing RAP would be a PG 52-28 or a PG 58-28.

For Marshall Mixes, no binder grade change will be required when Average Daily Traffic (ADT) is above 7000 or Commercial Average Daily Traffic (CADT) is above 700. No binder grade change will occur for LVSP, E03 and E1 mixtures used as leveling or top course.

The asphalt binder grade can also be selected using a blending chart for high and low temperatures. Supply the blending chart and the RAP test data used in determining the binder selection according to *AASHTO M 323*.

- **Tier 3 (\geq 28% RAP binder by weight of the total binder in the mixture).** The binder

grade for the asphalt binder is selected using a blending chart for high and low temperatures per *AASHTO M 323*. Supply the blending chart and the RAP test data used in determining the binder selection.

MICHIGAN
DEPARTMENT OF TRANSPORTATION

SPECIAL PROVISION
FOR
MARSHALL HOT MIX ASPHALT MIXTURE

CFS:JWB

1 of 2

APPR:EHR:CJB:09-25-06
FHWA:APPR:06-06-11

a. Description. Furnish hot mix asphalt (HMA) mixture, designed using Marshall Mixture Design Methods, in accordance with the standard specifications except as modified by this special provision.

b. Mix Design. Submit the mix design for evaluation in accordance with the Department's HMA Production Manual. Use a 50 blow Marshall hammer when compacting mixtures for developing Marshall mix designs.

c. Recycled Mixtures. Substituting reclaimed asphalt pavement (RAP) for a portion of the new material required to produce HMA mixture is allowed provided that the mixture is designed and produced to meet all criteria specified herein, unless otherwise prohibited. RAP materials must be in accordance with the standard specifications.

d. Materials. Table 1 provides the mix design criteria and volumetric properties. Table 2 provides the required aggregate properties. Use aggregates of the highest quality available to meet the minimum specifications. Use the mixture designation number shown in the contract item name when determining mix design properties from Tables 1 and 2.

e. Measurement and Payment. The completed work, as described, will be measured and paid for at the contract unit price using the following pay item:

Pay Item	Pay Unit
HMA, (type).....	Ton

Table 1: Mix Design Criteria and Volumetric Properties

	Mixture No.				
	2C	3C	4C	13A	36A
Target Air Void, % (a)	3.00	4.00	4.00	4.00	4.00
VMA (min) (b)	11.00	13.00	14.00	14.00	15.00
VFA	65-78	65-78	65-78	65-78	65-78
Fines to Binder Ratio (max) (c)	1.2	1.2	1.2	1.2	1.2
Flow (0.01 inch)	8 -16	8 -16	8 -16	8 -16	8 -16
Stability (min), lbs	1200	1200	1200	900	900
a. Lower target air voids by 1.00% if used in a separate shoulder paving operation. Consider reducing air void targets to 3.00% for lower traffic volume roadways when designing 13A and 36A mixtures for local agency use. b. VMA calculated using Gsb of the combined aggregates. c. Ratio of the weight of aggregate passing the No. 200 sieve to total asphalt binder content by weight; including fines and binder contributed by RAP.					

Table 2: Aggregate Properties

	Mixture No.				
	2C	3C	4C	13A	36A
	Percent Passing Indicated Sieve or Property Limit				
1½ inch	100				
1 inch	91-100	100			
¾ inch	90 max.	91-100	100	100	
½ inch	78 max.	90 max.	91-100	75-95	100
⅜ inch	70 max.	77 max.	90 max.	60-90	92-100
No. 4	52 max.	57 max.	67 max.	45-80	65-90
No. 8	15-40	15-45	15-52	30-65	55-75
No. 16	30 max.	33 max.	37 max.	20-50	
No. 30	22 max.	25 max.	27 max.	15-40	25-45
No. 50	17 max.	19 max.	20 max.	10-25	
No. 100	15 max.	15 max.	15 max.	5-15	
No. 200	3-6	3-6	3-6	3-6	3-10
Crushed (min), % (MTM 117)	90	90	90	25	60
Soft Particle (max), % (a)	12.0	12.0	8.0	8.0	8.0
Angularity Index (min) (b)	4.0	4.0	4.0	2.5	3.0
L.A. Abrasion (max), % loss (c)	40	40	40	40	40
Sand Ratio (max) (d)	-	-	-	50	50
<p>a. The sum of the shale, siltstone, structurally weak, and clay-ironstone particles must not exceed 8.0 percent for aggregates used in top course. The sum of the shale, siltstone, structurally weak, and clay-ironstone particles must not exceed 12.0 percent for aggregates used in base and leveling courses.</p> <p>b. The fine aggregate angularity of blended aggregates, determined by MTM 118, must meet the minimum requirement. In mixtures containing RAP, the required minimum fine aggregate angularity must be met by the virgin material. NAA fine aggregate angularity must be reported for information only and must include the fine material contributed by RAP if present in the mixture.</p> <p>c. Los Angeles abrasion maximum loss must be met for the composite mixture, however, each individual aggregate must be less than 50</p> <p>d. Sand ratio for 13A and 36A no more than 50% of the material passing the No. 4 sieve is allowed to pass the No. 30 Sieve.</p>					

MICHIGAN
DEPARTMENT OF TRANSPORTATION

SPECIAL PROVISION
FOR
ACCEPTANCE OF HOT MIX ASPHALT MIXTURE ON LOCAL AGENCY PROJECTS

CFS:KPK

1 of 7

APPR:CJB:JWB:07-05-16

FHWA:APPR:07-05-16

a. Description. This special provision provides sampling and testing requirements for local agency projects using the roller method and the nuclear density gauge testing. Provide the hot mix asphalt (HMA) mixture in accordance with the requirements of the standard specifications, except where modified herein.

b. Materials. Provide aggregates, mineral filler (if required), and asphalt binder to produce a mixture proportioned within the master gradation limits shown in the contract, and meeting the uniformity tolerance limits in Table 1.

Table 1: Uniformity Tolerance Limits for HMA Mixtures

Parameter		Top and Leveling Course		Base Course		
Number	Description	Range 1 (a)	Range 2	Range 1 (a)	Range 2	
1	% Binder Content	-0.30 to +0.40	±0.50	-0.30 to +0.40	±0.50	
2	% Passing	# 8 and Larger Sieves	±5.0	±8.0	±7.0	±9.0
		# 30 Sieve	±4.0	±6.0	±6.0	±9.0
		# 200 Sieve	±1.0	±2.0	±2.0	±3.0
3	Crushed Particle Content (b)	Below 10%	Below 15%	Below 10%	Below 15%	
a. This range allows for normal mixture and testing variations. The mixture must be proportioned to test as closely as possible to the Job-Mix-Formula (JMF). b. Deviation from JMF.						

Parameter number 2 as shown in Table 1 is aggregate gradation. Each sieve will be evaluated on one of the three gradation tolerance categories. If more than one sieve is exceeding Range 1 or Range 2 tolerances, only the one with the largest exceedance will be counted as the gradation parameter.

The master gradation should be maintained throughout production; however, price adjustments will be based on Table 1. Aggregates which are to be used in plant-mixed HMA mixtures must not contain topsoil, clay, or loam.

c. Construction. Submit a Mix Design and a JMF to the Engineer. Do not begin production and placement of the HMA until receipt of the Engineer's approval of the JMF. Maintain the binder content, aggregate gradation, and the crushed particle content of the HMA mixture within the Range 1 uniformity tolerance limits in Table 1. For mixtures meeting the definition of top or leveling course, field regress air void content to 3.5 percent with liquid asphalt cement unless

specified otherwise on HMA application estimate. For mixtures meeting the definition of base course, field regress air void content to 3.0 percent with liquid asphalt cement unless specified otherwise on HMA application estimate.

Ensure all persons performing Quality Control (QC) and Quality Assurance (QA) HMA field sampling are "Local Agency HMA Sampling Qualified" samplers. At the Pre-Production or Pre-Construction meeting, the Engineer will determine the method of sampling to be used. Ensure all sampling is done in accordance with *MTM 313 (Sampling HMA Paving Mixtures)* or *MTM 324 (Sampling HMA Paving Mixtures Behind the Paver)*. Samples are to be taken from separate hauling loads.

For production/mainline type paving, obtain a minimum of two samples, each being 20,000 grams, each day of production, for each mix type. The Engineer will sample and maintain possession of the sample. Sampling from the paver hopper is prohibited. Each sample will be divided into two 10,000 gram parts with one part being for initial testing and the other part being held for possible dispute resolution testing. Obtain a minimum of three samples for each mix type regardless of the number of days of production.

Obtain samples that are representative of the day's paving. Sample collection is to be spaced throughout the planned tonnage. One sample will be obtained in the first half of the tonnage and the second sample will be obtained in the second half of the tonnage. If planned paving is reduced or suspended, when paving resumes, the remaining sampling must be representative of the original intended sampling timing.

Ensure all persons performing testing are Bit Level One certified or Bit QA/QC Technician certified.

Ensure daily test samples are obtained, except, if the first test results show that the HMA mixture is in specification, the Engineer has the option of not testing additional samples from that day.

At the Pre-Production or Pre-Construction meeting, the Engineer and Contractor will collectively determine the test method for measuring asphalt content (AC) using *MTM 319 (Determination of Asphalt Content from Asphalt Paving Mixtures by the Ignition Method)* or *MTM 325 (Quantitative Extraction of Bitumen from HMA Paving Mixtures)*. Back calculation will not be allowed for determining asphalt content.

Ensure all labs performing local agency acceptance testing are qualified labs per the *HMA Production Manual* and participate in the MDOT round robin process, or they must be *AASHTO Materials Reference Laboratory (AMRL)* accredited for *AASHTO T 30* or *T 27*, and *AASHTO T 164* or *T 308*. Ensure on non-National Highway System (NHS) routes, Contractor labs are made available, and may be used, but they must be qualified labs as previously stated. Contractor labs may not be used on NHS routes. Material acceptance testing will be completed by the Engineer within 14 calendar days, except holidays and Sundays, for projects with less than 5,000 tons (plan quantity) of HMA and within 7 calendars days, except holidays and Sundays, for projects with 5,000 tons (plan quantity) or more of HMA, after the Engineer has obtained the samples. QA test results will be provided to the Contractor after the Engineer receives the QC test results. Failure on the part of the Engineer or the laboratory to provide Quality Assurance test results within the specified time frame does not relieve the Contractor of their responsibility to provide an asphalt mix within specifications.

The correlation procedure for ignition oven will be established as follows. Asphalt binder content based on ignition method from MTM 319. Gradation (*ASTM D 5444*) and Crushed particle content (*MTM 117*) based on aggregate from *MTM 319*. The incineration temperature will be established at the Pre-Production Meeting. The Contractor will provide a laboratory mixture sample to the acceptance laboratory to establish the correction factor for each mix. Ensure this sample is provided to the Engineer a minimum of 14 calendar days prior to production.

For production/mainline type paving, the mixture may be accepted by visual inspection up to a quantity of 500 tons per mixture type, per project (not per day). For non-production type paving defined as driveways, approaches, and patching, visual inspection may be allowed regardless of the tonnage.

The mixture will be considered out-of-specification, as determined by the acceptance tests, if for any one mixture, two consecutive tests per parameter, (for Parameter 2, two consecutive aggregate gradations on one sieve) are outside Range 1 or Range 2 tolerance limits. If a parameter is outside of Range 1 tolerance limits and the second consecutive test shows that the parameter is outside of Range 2, then it will be considered to be a Range 1 out-of-specification. Consecutive refers to the production order and not necessarily the testing order. Out-of-specification mixtures are subject to a price adjustment per the Measurement and Payment section of this special provision.

Contractor operations will be suspended when the mixture is determined to be out-of-specification, but contract time will continue to run. The Engineer may issue a Notice of Non-Compliance with Contract Requirements (Form 1165), if the Contractor has not suspended operations and taken corrective action. Submit a revised JMF or proposed alterations to the plant and/or materials to achieve the JMF to the Engineer. Effects on the Aggregate Wear Index (AWI) and mix design properties will be taken into consideration. Production and placement cannot resume until receipt of the Engineer's approval to proceed.

Pavement in-place density will be measured using one of two approved methods. The method used for measuring in-place density will be agreed upon at a pre-production or pre-construction meeting.

Pavement in-place density tests will be completed by the Engineer during paving operations and prior to traffic staging changes. Pavement in-place density acceptance testing will be completed by the Engineer prior to paving of subsequent lifts and being open to traffic.

Option 1 – Direct Density Method

Use of a nuclear density gauge requires measuring the pavement density using the Gmm from the JMF for the density control target. The required in-place density of the HMA mixture must be 92.0 to 98.0 percent of the density control target. Nuclear density testing and frequency will be in accordance with the *MDOT Density Testing and Inspection Manual*.

Option 2 – Roller Method

The Engineer may use the Roller Method with a nuclear or non-nuclear density gauge to document achieving optimal density as discussed below.

Use of the density gauge requires establishing a rolling pattern that will achieve the required in-place density. The Engineer will measure pavement density with a density gauge using the Gmm from the JMF for the density control target.

Use of the Roller Method requires developing and establishing density frequency curves, and meeting the requirements of Table 2. A density frequency curve is defined as the measurement and documentation of each pass of the finished roller until the in-place density results indicate a decrease in value. The previous recording will be deemed the optimal density. The Contractor is responsible for establishing and documenting an initial or QC rolling pattern that achieves the optimal in-place density. When the density frequency curve is used, the Engineer will run and document the density frequency curve for each half day of production to determine the number of passes to achieve the maximum density. Table 5, located at the end of this special provision, can be used as an aid in developing the density frequency curve. The Engineer will perform density tests using an approved nuclear or non-nuclear gauge per the manufacturer's recommended procedures.

Table 2: Minimum Number of Rollers Recommended Based on Placement Rate

Average Laydown Rate, Square Yards per Hour	Number of Rollers Required (a)	
	Compaction	Finish
Less than 600	1	1 (b)
601 - 1200	1	1
1201 - 2400	2	1
2401 - 3600	3	1
3601 and More	4	1
a. Number of rollers may increase based on density frequency curve.		
b. The compaction roller may be used as the finish roller also.		

After placement, roll the HMA mixture as soon after placement as the roller is able to bear without undue displacement or cracking. Start rolling longitudinally at the sides of the lanes and proceed toward the center of the pavement, overlapping on successive trips by at least half the width of the drum. Ensure each required roller is 8 tons minimum in weight unless otherwise approved by the Engineer.

Ensure the initial breakdown roller is capable of vibratory compaction and is a maximum of 500 feet behind the paving operations. The maximum allowable speed of each roller is 3 miles per hour (mph) or 4.5 feet per second. Ensure all compaction rollers complete a minimum of two complete rolling cycles prior to the mat temperature cooling to 180 degrees Fahrenheit (F). Continue finish rolling until all roller marks are eliminated and no further compaction is possible. The Engineer will verify and document that the roller pattern has been adhered to. The Engineer can stop production when the roller pattern is not adhered to.

d. Measurement and Payment. The completed work, as described, will be measured and paid for using applicable pay items as described in subsection 501.04 of the Standard Specifications for Construction, or the contract, except as modified below.

Base Price. Price established by the Department to be used in calculating incentives and adjustments to pay items and shown in the contract.

If acceptance tests, as described in section c. of this special provision, show that a Table 1 mixture parameter exceeds the Range 1, but not the Range 2, tolerance limits, that mixture parameter will be subject to a 10 percent penalty. The 10 percent penalty will be assessed based on the acceptance tests only unless the Contractor requests that the 10,000 gram sample part retained for possible dispute resolution testing be tested. The Contractor has 4 calendar days from receipt of the acceptance test results to notify the Engineer, in writing, that dispute resolution testing is requested. The Contractor's QC test results for the corresponding QA test results must result in an overall payment greater than QA test results otherwise the QA tests will not be allowed to be disputed. The Engineer has 4 calendar days to send the dispute resolution sample to the lab once dispute resolution testing is requested. The dispute resolution sample will be sent to an independent lab selected by the Local Agency, and the resultant dispute test results will be used to determine the penalty per parameter, if any. Ensure the independent lab is a MDOT QA/QC qualified lab or an AMRL HMA qualified lab. The independent lab must not have conflicts of interest with the Contractor or Local Agency. If the dispute testing results show that the mixture parameter is out-of-specification, the Contractor will pay for the cost of the dispute resolution testing and the contract base price for the material will be adjusted, based on all test result parameters from the dispute tests, as shown in Table 3 and Table 4. If the dispute test results do not confirm the mixture parameter is out-of-specification, then the Local Agency will pay for the cost of the dispute resolution testing and no price adjustment is required.

If acceptance tests, as described in section c. of this special provision, show that a Table 1 mixture parameter exceeds the Range 2 tolerance limits, the 10,000 gram sample part retained for possible dispute resolution testing will be sent, within 4 calendar days, to the MDOT Central Laboratory for further testing. The MDOT Central Laboratory's test results will be used to determine the penalty per mixture parameter, if any. If the MDOT Central Laboratory's results do not confirm the mixture parameter is out-of-specification, then no price adjustment is required. If the MDOT Central Laboratory's results show that the mixture is out-of-specification and the Engineer approves leaving the out-of-specification mixture in place, the contract base price for the material will be adjusted, based on all parameters, as shown in Table 3 and Table 4.

In the case that the Contractor disputes the results of the test of the second sample obtained for a particular day of production, the test turn-around time frames given would apply to the second test and there would be no time frame on the first test.

The laboratory (MDOT Central Laboratory or independent lab) will complete all Dispute Resolution testing and return test results to the Engineer, who will provide them to the Contractor, within 13 calendar days upon receiving the Dispute Resolution samples.

In all cases, when penalties are assessed, the penalty applies to each parameter, up to two parameters, that is out of specification.

Table 3: Penalty Per Parameter

Mixture Parameter out-of-Specification per Acceptance Tests	Mixture Parameter out-of-Specification per Dispute Resolution Test Lab	Price Adjustment per Parameter
NO	N/A	None
YES	NO	None
	YES	Outside Range 1 but not Range 2: decrease by 10%
		Outside Range 2: decrease by 25%

The quantity of material receiving a price adjustment is defined as the material produced from the time the first out-of-specification sample was taken until the time the sample leading to the first in-specification test was taken.

Each parameter of Table 1 is evaluated with the total price adjustment applied to the contract base price based on a sum of the two parameter penalties resulting in the highest total price adjustment as per Table 4. For example, if three parameters are out-of-specification, with two parameters outside Range 1 of Table 1 tolerance limits, but within Range 2 of Table 1 limits and one parameter outside of Range 2 of Table 1 tolerance limits and the Engineer approves leaving the mixture in place, the total price adjustment for that quantity of material is 35 percent.

Table 4: Calculating Total Price Adjustment

Cost Adjustment as a Sum of the Two Highest Parameter Penalties		
Number of Parameters Out-of-Specification	Range(s) Outside of Tolerance Limits of Table 1 per Parameter	Total Price Adjustment
One	Range 1	10%
	Range 2	25%
Two	Range 1 & Range 1	20%
	Range 1 & Range 2	35%
	Range 2 & Range 2	50%
Three	Range 1, Range 1 & Range 1	20%
	Range 1, Range 1 & Range 2	35%
	Range 1, Range 2 & Range 2	50%
	Range 2, Range 2 & Range 2	50%

Table 5: Density Frequency Curve Development

Tested by: _____ Date/Time: _____

Route/Location:		Air Temp:
Control Section/Job Number:		Weather:
Mix Type:	Tonnage:	Gauge:
Producer:	Depth:	Gmm:

Roller #1 Type:

Pass No.	Density	Temperature	Comments
1			
2			
3			
4			
5			
6			
7			
8			
Optimum			

Roller #2 Type:

Pass No.	Density	Temperature	Comments
1			
2			
3			
4			
5			
6			
7			
8			
Optimum			

Roller #3 Type:

Pass No.	Density	Temperature	Comments
1			
2			
3			
4			
5			
6			
7			
8			
Optimum			

Summary: _____

MICHIGAN
DEPARTMENT OF TRANSPORTATION

SPECIAL PROVISION
FOR
HOT MIX ASPHALT PRICES FOR ADJUSTMENTS

AA:DAD

1 of 1

APPR:LFS:BCW:11-25-15

a. Description. This special provision identifies the price(s) that will be used in all payment adjustments for work related to hot mix asphalt item(s) used in conjunction with this contract.

If the Contractors bid is lower than the established base price any positive adjustment will use the Contractors bid in the calculation for the adjustment. If the Contractors bid is lower than the established base price any negative adjustment will use the base price established herein in the calculation for the adjustment.

If the Contractors bid is higher than the established base price any positive adjustment will use the Contractors bid in the calculation for the adjustment. If the Contractors bid is higher than the established base price any negative adjustment will use the Contractors bid in the calculation for the adjustment.

b. Base Unit Prices. The base price(s) shown below will be used as specified above in calculating adjustments for the pay item(s) listed herein:

Pay Item Code	Pay Item Name	Unit	Base Price
5010025	Hand Patching	Ton	\$83.78
5010034	HMA, 36A	Ton	\$60.80
5010045	HMA, 3E3	Ton	\$56.48
5010051	HMA, 4E3	Ton	\$60.26
5010057	HMA, 5E3	Ton	\$62.10
5010061	HMA Approach	Ton	\$86.48
5010703	HMA, LVSP	Ton	\$54.11

MICHIGAN
DEPARTMENT OF TRANSPORTATION

SPECIAL PROVISION
FOR
LOW-TRACKING BOND COAT EMULSIFIED ASPHALT, PERMISSIVE USE

CFS:TRC

1 of 2

APPR:JWB:KPK:06-01-16
FHWA APPR:06-07-16

a. Description. This work consists of electing to furnish low-tracking bond coat emulsified asphalt in lieu of standard bond coat. Ensure all work is in accordance with section 904 of the Standard Specifications for Construction and applicable special provisions, except as modified herein. The low-tracking bond coat emulsified asphalt must conform to approved acceptance test methods and procedures described in the Materials Quality Assurance Procedures Manual. No deviations to acceptance test methods and procedures will be allowed.

b. Materials. The following types of low-tracking bond coat emulsified asphalt are allowed in lieu of the standard bond coat.

Table 1: Low-Tracking Bond Coat (LTBC) Emulsified Asphalt

Emulsified Asphalt Type	Specification Requirements
LTBC-1	Table 2
LTBC-2	Table 3

Table 2: Specification Requirements for LTBC-1

Parameter	Test Method	Minimum	Maximum
Saybolt Furol Viscosity, SFS @ 25 degrees C	AASHTO T59	15	100
Storage Stability, 24 Hrs, %	AASHTO T59	--	1
Storage Stability, 5 Days, %	AASHTO T59	--	5
Residue By Distillation, %	AASHTO T59	50	--
Oil Distillate, %	AASHTO T59	--	1
Sieve Test, %	AASHTO T59	--	0.30
Tests On Residue			
Penetration, @ 25 degrees C	AASHTO T49	--	20
Softening Point Range degrees C	AASHTO T53	60	--
Solubility, %	AASHTO T44	97.5	--

Table 3: Specification Requirements for LTBC-2

Parameter	Test Method	Minimum	Maximum
Saybolt Furol Viscosity, SFS @ 25 degrees C	AASHTO T59	15	100
Storage Stability, 5 Days, %	AASHTO T59	--	5
Residue By Distillation, %	AASHTO T59	50	--
Oil Distillate, %	AASHTO T59	--	1
Sieve Test, %	AASHTO T59	--	0.30
Tests On Residue			
Penetration, @ 25 degrees C	AASHTO T49	--	40
Solubility, %	AASHTO T44	97.5	--

c. Construction. Construct in accordance with subsection 501.03 of the Standard Specifications for Construction.

d. Measurement and Payment. When electing to substitute a low-tracking bond coat emulsified asphalt for the standard bond coat, it is with the understanding that the pay items in the original contract will not be changed and the low-tracking bond coat emulsified asphalt will be provided under those original pay items at the bid prices submitted.

MICHIGAN
DEPARTMENT OF TRANSPORTATION

SPECIAL PROVISION
FOR
RECESSED PAVEMENT MARKINGS

PMK:MKB

1 of 2

APPR:JJG:MWB:07-05-16

FHWA:APPR:07-13-16

a. Description. This work consists of providing all equipment and labor required to prepare (grooving) the pavement surface for recessed longitudinal, transverse, and turning guide line pavement markings in accordance with section 811 of the Standard Specifications for Construction, the plans, and this special provision.

b. Materials. None specified.

c. Construction. Install a recess (groove) in accordance with the pavement marking material manufacturer's installation instructions. Ensure all recessing configurations are in accordance with the *Michigan Manual of Uniform Traffic Control Devices* and the Department Pavement Marking Standards.

1. Grooving Concrete and Hot Mix Asphalt Pavement. If there are no markings on the pavement, paint a temporary tracer line (with no beads) exactly where the permanent markings will be placed. Use these lines as a template for the grooving operation.

Use equipment and methods approved by the manufacturer of the pavement marking material to be recessed for forming grooves in pavement surfaces. Dry-cut the grooves in a single pass using stacked diamond cutting heads on self-vacuuming equipment capable of producing a finished groove ready for pavement marking material installation.

Ensure that the bottom of the groove has a fine corduroy finish. If a coarse tooth pattern results, increase the number of blades and decrease the spaces on the cutting head until the required finish is achieved.

2. Groove Dimensions. Ensure grooves for recessed pavement markings are in accordance with the following:

Longitudinal Markings

Groove Width:	Material width +1 inch, ($\pm 1/8$ inch)
Groove Depth:	As recommended by the manufacturer, (± 5 mils)
Groove Position:	Center/Lane Lines: 2 inches from joint line, ($\pm 1/8$ inch)
	Edge Lines: On lane, 2-4 inches in from the joint line, ($\pm 1/8$ inch)
	Edge Lines for 14 foot paved lanes: as directed by the Engineer

Transverse Markings - Stop Bars, Crosswalks, and Cross Hatching

Groove Width:	Material width +1 inch, ($\pm 1/8$ inch)
Groove Depth:	As recommended by the manufacturer, (± 5 mils)

Groove Position: In the exact location where the transverse marking will be placed

Transverse Markings - Symbols and Legends

Groove Width: Size of the complete symbol or legend plus the width to smoothly zero out the groove depth

Groove Depth: As recommended by the manufacturer, (± 5 mils)

Groove Position: In the exact location where the transverse marking will be placed

Turning Guide Line Markings

Groove Width: Material width +1 inch, ($\pm 1/8$ inch)

Groove Depth: As recommended by the manufacturer, (± 5 mils)

Groove Position: In the exact location where the turning guide line markings will be placed

3. Placing Recessed Pavement Markings. Place the pavement marking material in the grooves within 24 hours of the grooves being made. Ensure the grooves are clean and dry prior to placing pavement marking material. Locate the groove so the entire marking can be placed within the groove.

d. Measurement and Payment. The completed work, as described, will be measured and paid for at the contract unit price using the following pay items:

Pay Item	Pay Unit
Recessing Pavt Mrkg, Longit	Foot
Recessing Pavt Mrkg, Transv	Square Foot
Recessing Pavt Mrkg, Turning Guide Line.....	Square Foot

Recessing Pavt Mrkg, Longit; Recessing Pavt Mrkg, Transv; and Recessing Pavt Mrkg, Turning Guide Line includes placing the temporary tracer line (with no beads), when required, and all work as described in this special provision.

Permanent pavement marking materials and temporary retroreflective pavement markings required for traffic control will be paid for separately using the appropriate pay items.

MICHIGAN
DEPARTMENT OF TRANSPORTATION

SPECIAL PROVISION
FOR
WET REFLECTIVE LIQUID APPLIED PAVEMENT MARKINGS

PMK:MKB

1 of 2

APPR:MWB:DBP:03-24-16

FHWA:APPR:03-24-16

a. Description. This work consists of furnishing and installing wet night retroreflective (WR) beads and/or elements and liquid applied pavement marking materials.

b. Materials.

1. Wet Night Retroreflective Beads and/or Elements. Select WR beads and/or elements from one of the following Manufacturers or a Department approved alternative that meets the requirements in Table 1:

3M Corporation
Potter's Industries
Swarco
Flex-o-Lite

Table 1: WR Markings

Average Initial Retroreflectivity at 30 meter geometry in mcd/lux/m ²		
Test Method	Color	
	White	Yellow
Dry (ASTM E 1710)	700	500
Wet Recovery (ASTM E 2177)	250	200

Ship the material to the job site in sturdy containers marked in accordance with subsection 920.01.A of the Standard Specifications for Construction.

Submit to the Engineer prior to the start of work:

A. The Manufacturer's recommended application rate of the beads/elements and the liquid applied pavement marking binder to be used on the project. If the Manufacturer's recommended application rate differs from the specified rate in Table 811-1 of the Standard Specifications for Construction, the Manufacturer's recommended rate supersedes the table values.

B. Certification from the Manufacturer that when applied according to their application recommendations the beads and/or elements meet the requirements shown in Table 1 above.

2. Binder. Provide a liquid pavement marking product of the binder type specified in the contract documents from section 811 of the Qualified Products List or as specified by special provision, or use an alternative binder as approved by the Engineer.

c. Construction. Place the binder and beads in accordance with the Manufacturers' recommendations and sections 811 and 920 of the Standard Specifications for Construction except as noted above.

d. Measurement and Payment. The completed work, as described, will be measured and paid for at contract unit prices using the following pay items:

Pay Item	Pay Unit
Pavt Mrkg, Wet Retrflec (binder), __ inch, (color)	Foot

MICHIGAN
DEPARTMENT OF TRANSPORTATION

SPECIAL PROVISION
FOR
PERMANENT PAVEMENT MARKINGS

PMK:MKB

1 of 2

APPR:MWB:CRB:07-07-16
FHWA:APPR:07-13-16

Add the following to the end of the list of materials in subsection 811.02, on page 588 of the Standard Specifications for Construction:

Modified Urethane Pavement Marking Material	920
Preformed Thermoplastic Pavement Marking Material	920

Ensure preformed thermoplastic materials have a thickness of 125 mils.

Add the following row to Table 811-1 of subsection 811.03.B, on page 591 of the Standard Specifications for Construction:

Polyurea	20	Binder (gal)	5.5	8.25	11	17	22	33	44	66
		Bead (lb)	As directed by the manufacturer							
Modified Urethane	20	Binder (gal)	5.5	8.25	11	17	22	33	44	66
		Bead (lb)	As directed by the manufacturer							

Add the following paragraph after the fifth paragraph of subsection 811.03.B, on page 592 of the Standard Specifications for Construction:

Beads are not to be placed in liquid shadow markings.

Add the following subsections after the last paragraph of subsection 811.03.D.7.c, on page 595 of the Standard Specifications for Construction:

8. **Modified Urethane.** Ensure the pavement is free of excess surface and subsurface moisture that may affect bonding. The Engineer will not decide the suitability of specific days for the application of modified urethane.

Surface preparation requirements for special, and longitudinal modified urethane pavement markings depend on surface conditions.

Prepare new HMA surfaces and HMA surfaces open to traffic for 10 days or less with no oil drips, residue, debris, or temporary or permanent markings, by cleaning the marking area with compressed air.

Prepare new PCC surfaces and PCC surfaces free of oil drips, residue, and debris, temporary, or permanent markings, by removing the curing compound from the area required for pavement markings.

Prepare existing HMA or PCC surfaces that do not have existing markings, but may have oil drip areas, debris, or both, by scarifying the marking area using non-milling grinding teeth or shot blasting. The Engineer will allow the use of water blasting to scarify the marking area on PCC surfaces.

Prepare existing HMA or PCC surfaces with existing pavement markings and that may have oil drip areas, debris, or both, by using the following methods:

- a. For existing liquid pavement markings, scarify the proposed marking area using non-milling grinding teeth or shot blast. Occasionally existing liquid pavement markings will require complete removal, which will be determined by the Engineer.
- b. For existing cold plastic markings, completely remove the existing markings.

- 9. **Preformed Thermoplastic.** Ensure the pavement is free of excess surface and subsurface moisture that may affect bonding. The Engineer will not decide the suitability of specific days for the application of preformed thermoplastic.

Heat and apply the preformed thermoplastic material as recommended by the manufacturer. Feather all edges of the material with a putty knife while the preformed thermoplastic is still soft.

Add the following rows to Table 811-2 of subsection 811.03.D, on page 596 of the Standard Specifications for Construction:

Modified Urethane	40	40	Apr. 15	Nov. 15
Preformed Thermoplastic	35	35	Apr. 15	Nov. 15

Add the following pay items to the list of pay items in subsection 811.04, on page 598 of the Standard Specifications for Construction:

- Pavt Mrkg, Modified Urethane, (symbol).....Each
- Pavt Mrkg, Modified Urethane, (legend)Each
- Pavt Mrkg, Modified Urethane, __ inch, CrosswalkFoot
- Pavt Mrkg, Modified Urethane, __ inch, Stop BarFoot
- Pavt Mrkg, Modified Urethane, __ inch, Cross Hatching (color).....Foot
- Pavt Mrkg, Modified Urethane, __ inch, (color).....Foot
- Pavt Mrkg, Ovly Cold Plastic, __ inch, Shadow Tape, Black.....Foot
- Pavt Mrkg, Ovly Cold Plastic, __ inch, Wet Reflective, (color)Foot
- Pavt Mrkg, Preformed Thermoplastic, (symbol).....Each
- Pavt Mrkg, (binder), __ inch, Shadow Liquid, Black.....Foot

MICHIGAN
DEPARTMENT OF TRANSPORTATION

SPECIAL PROVISION
FOR
**MINOR TRAFFIC DEVICES AND TRAFFIC REGULATOR CONTROL DURING AN
APPROVED EXTENSION OF TIME**

OPR:CRB

1 of 1

APPR:JJG:DBP:09-27-12

FHWA:APPR:10-04-12

Delete the first sentence of the second paragraph in subsection 812.04.U, Price Adjustments for Authorized Extensions of Time, on page 631 of the Standard Specifications for Construction and replace with the following.

The Department will not make price adjustments for temporary traffic control devices, Minor Traf Devices, and Traf Regulator Control during authorized extensions of time if liquidated damages are assessed in accordance with subsection 108.08 and subsection 108.09.

Delete the third paragraph and Formula 812-1 of subsection 812.04.U, Price Adjustments for Authorized Extensions of Time, on page 631 of the Standard Specifications for Construction, that starts with “The Department will use the following formula...” and replace with the following.

The Department will use the following formula to calculate the unit price adjustments. The adjustment for Minor Traf Devices will be at a daily rate of (a/b) not to exceed \$900.00 per calendar or work day and the adjustment for Traf Regulator Control will be at a daily rate of (a/b) not to exceed \$650.00 per calendar or work day. When calculating the adjustment, either calendar or working days will be used for both original contract time and additional days.

$a/b \times c =$ Unit price adjustment

Formula 812-1

where:

a = Original contract unit price.

b = Original contract time (For calendar date projects the original contract time will be calculated as the number of calendar days from the start date to the contract completion date as identified on the progress schedule, form 1130).

c = Additional days the item was in use or required to be on standby during the authorized extension of time.

MICHIGAN
DEPARTMENT OF TRANSPORTATION

SPECIAL PROVISION
FOR
PAYMENT FOR MINOR TRAFFIC DEVICES AND TRAFFIC REGULATOR CONTROL

OPR:JJG

1 of 1

APPR:BJO:DBP:07-19-11
FHWA:APPR:07-19-11

Delete Table 812-1 in subsection 812.04.E, on page 625 of the Standard Specifications for Construction, in its entirety and replace with the following.

Table 812-1 Partial Payment Schedule for Minor Traf Devices and Traffic Regulator Control

Percent of Original Contract Amount Earned	Total Percent of Unit Price Paid
First Use	15
25	30
50	55
75	80
90	100

MICHIGAN
DEPARTMENT OF TRANSPORTATION

SPECIAL PROVISION
FOR
SUPPORTS FOR TEMPORARY SIGNS

OPR:CRB

1 of 1

APPR:MWB:DBP:06-26-12
FHWA:APPR:08-18-12

Delete the last paragraph of subsection 812.03.D.3, on page 604 of the Standard Specifications for Construction in its entirety, and replace with the following.

Mount construction signs on portable sign support standards only if signs are to remain in place for 14 days or less, or as allowed by the Engineer if fixed supports are not possible.

MICHIGAN
DEPARTMENT OF TRANSPORTATION

SPECIAL PROVISION
FOR
SECURITY OF PORTABLE CHANGEABLE MESSAGE SIGNS

OFS:CRB

1 of 1

APPR:LWB:DBP:10-09-13
FHWA:APPR:10-09-13

a. Description. This work consists of making certain the portable changeable message sign (PCMS) is secure, and complies with the following:

1. Create unique usernames and passwords (not defaults) for access to the PCMS local controls.
2. Remove all literature (manuals, instructions, etc.) from the PCMS controller enclosure.
3. Use a padlock, keyed lock, etc to prevent access to the controller enclosure.
4. Provide the Engineer up to 3 keys, or the lock combination, as well as the usernames and passwords.
5. Provide at minimum, one classroom style training session of 2 hours, on PCMS field equipment, including but not limited to: posting and removal of messages, diagnosing field equipment malfunctions including messaging and communications errors. All training schedules, syllabus and materials are to be supplied by the Contractor and approved by the Engineer prior to delivery of training. Unless otherwise specified by the Engineer, the number of participants at each training session will be limited to a maximum of 20 individuals

MDOT reserves the right to take full messaging control of any PCMS at any time throughout the duration of the project. This includes posting any message determined to be appropriate by MDOT

MDOT may, at any time, inspect PCMS boards that are on site to verify that the security measures in this special provision are being followed.

MICHIGAN
DEPARTMENT OF TRANSPORTATION

SPECIAL PROVISION
FOR
MEASUREMENT AND PAYMENT OF TEMPORARY TRAFFIC CONTROL DEVICES

OFS:CRB

1 of 1

APPR:MWB:JJG:02-27-14

FHWA:APPR:03-04-14

Delete subsection 812.04.A.4, on page 624 of the Standard Specifications for Construction in its entirety.

Delete the second paragraph of subsection 812.04.C, on page 624 of the Standard Specifications for Construction in its entirety, and replace with the following:

The Engineer will measure **Sign, Type __, Temp, Prismatic, Furn** as the total cumulative area of the maximum number of each sign legend that is in use during the course of the project unless previously paid. The unit price for **Sign, Type __, Temp, Prismatic, Furn** includes the cost of portable or driven sign supports.

Delete the second paragraph of subsection 812.04.D, on page 624 of the Standard Specifications for Construction in its entirety, and replace with the following:

The Engineer will measure **Sign, Type __, Temp, Prismatic, Oper** as the total cumulative area of the maximum number of each sign legend that is in use during the course of the project unless previously paid.

MICHIGAN
DEPARTMENT OF TRANSPORTATION

SPECIAL PROVISION
FOR
TYPE III BARRICADES

DES:DBP

1 of 1

APPR:MWB:CRB:08-07-15
FHWA:APPR:08-23-15

Delete the first sentence for the second paragraph in subsection 812.03.D.8 on page 606 of the Standard Specifications for Construction, and replace with the following:

Light Type III barricades with two, Type C or Type D warning lights, fastened to the uprights above the top rail, provided these warning lights each weigh 3.3 pounds or less.

Delete the following pay items from the list in subsection 812.04 on page 622 of the Standard Specifications for Construction.

Barricade, Type III, High Intensity, Furn.....	Each
Barricade, Type III, High Intensity, Oper	Each
Barricade, Type III, High Intensity, Double Sided, Furn	Each
Barricade, Type III, High Intensity, Double Sided, Oper	Each

Renumber the existing subsection 812.04.A.5 on page 624 of the Standard Specifications for Construction, as follows:

4. The manufacturer's invoiced cost for damaged equipment included in a lump sum pay item for maintaining traffic.

MICHIGAN
DEPARTMENT OF TRANSPORTATION

SPECIAL PROVISION
FOR
TEMPORARY PAVEMENT MARKING REVISIONS

OFS:CGB

1 of 4

APPR:MWB:MKB:02-12-16
FHWA:APPR:02-23-16

Delete subsection 812.03.D.11.a, on page 610 of the Standard Specifications for Construction, in its entirety and replace with the following:

- a. **Temporary Pavement Marking – Wet Reflective Type R.** Use temporary wet reflective pavement marking Type R (removable tape) when temporary pavement markings must be placed on finished pavements and are not in the exact location as future permanent markings or at the discretion of the Engineer when temporary markings must be removed during the life of a project.

Ensure prior to installation the pavement surface is air blown or brushed to remove surface dust and dirt. Remove curing compound from new concrete surfaces before applying Type R Tape.

Place wet reflective Type R tape when it is used as a 4-foot dash or full length skip line as defined in the contract to temporarily mark finished pavement prior to the placement of permanent markings according to the Manufacturer's specifications for existing temperature and pavement condition. Offset it 1 foot from the permanent marking so that the permanent markings can be placed prior to the removal of the 4-foot dashes or full length skip line. Do not use 4-foot dashes or full length skip lines to temporarily mark a solid edge line. Ensure damaged or missing tape of more than 2 consecutive skip lines, is replaced at no cost to the Department within 24 hours after notification by the Engineer. Failure to replace the tape within the 24 hour time period will result in a contract price adjustment as described in the Special Provision for Traffic Control Quality and Compliance.

- i. Between April 15 and November 1, place wet reflective Type R tape not used as a skip line according to the Manufacturer's specifications for existing temperature and pavement condition. Replace wet reflective Type R tape of more than 50 cumulative feet that fails, at no cost to the Department within 24 hours after notification by the Engineer. Failure to replace the tape within the 24 hour time period will result in a contract price adjustment as described in the Special Provision for Traffic Control Quality and Compliance.
- ii. From November 2 to December 1 and March 15 to April 14, place wet reflective Type R tape for all temporary shifts and tapers when pavement surfaces are dry and air temperatures are 40 degrees Fahrenheit and rising. All wet reflective Type R tape placed during these times must be placed during approved daytime hours negotiated between the Engineer and the Contractor or daytime hours required in the contract. Do not place wet reflective Type R tape within 24 hours of predicted precipitation, or 24 hours after any precipitation. The Contractor will be paid to

repair locations that fail during these times unless the Engineer determines the failure is due to improper surface preparation, or failure to follow these requirements. Repairs, if required, will be paid for at a negotiated price between the Engineer and the Contractor for the associated work.

- iii. Use temporary wet reflective pavement marking Type NR paint, for all tapers and shifts when ambient air temperature is less than 40 degrees Fahrenheit. To remove the wet reflective Type NR paint, use the least abrasive technique as directed by the Engineer to minimize scarring. If the approved pavement marking removal pay item is not part of the contract, the cost of the removal of Type NR pavement markings will be negotiated between the Engineer and the Contractor.
- iv. Wet reflective Type R tape is not to be placed between December 2 and March 14.

Delete subsection 812.03.D.11.b, on page 610 of the Standard Specifications for Construction, in its entirety and replace with the following:

b. Temporary Pavement Marking.

- i. **Wet Reflective Type NR Paint.** Use temporary pavement marking Wet Reflective Type NR paint when temporary pavement markings must be placed on pavement to be removed or replaced during construction. They also must be used when temporary markings line up exactly with the placement of permanent markings and may be grooved out prior to recessing permanent markings. The temporary pavement marking material must be compatible with the material specified for the permanent markings if permanent markings are to be placed on top of temporary markings.

Place Wet Reflective Type NR paint in accordance with section 811. Place the material at a thickness of 18 mils while driving at a maximum rate of 8 miles per hour. Drop WR optics from the forward most bead applicator gun at a rate of 4 pounds per gallon. Drop glass beads at a rate of 6 pounds per gallon from the rear bead applicator gun.

Place Wet Reflective Type NR paint, used as a 4-foot dash or full length skip line as defined in the contract, to temporarily mark finished pavement prior to the placement of permanent markings, in the exact location as the permanent marking such that its removal is not necessary. Only use Wet Reflective Type NR markings compatible with the permanent pavement marking material specified on the project as a 4-foot dash or full length skip line. Do not use 4-foot dashes or full length skip lines to temporarily mark a solid edgeline.

- ii. **Type NR Tape.** Use temporary pavement marking Type NR Tape as a 4 foot dash or full length skip line as defined in the contract to temporarily mark a white skip line or yellow centerline on base or leveling course of pavement. Type NR tape must not be used to temporarily mark a solid edgeline. Type NR tape is not to be used on the wearing course of asphalt or on existing pavement.

Place Type NR tape in accordance with section 811.

Delete the following pay items from the list of pay items in subsection 812.04, on page 623 of the Standard Specifications for Construction:

Pavt Mrkg, Type R, 4 inch, (color), TempFoot
 Pavt Mrkg, Type NR, Paint, 4 inch, (color), TempFoot

Add the following pay items to the list of pay items in subsection 812.04, on page 623 of the Standard Specifications for Construction:

Pavt Mrkg, Wet Reflective, Type R, Tape, 4 inch, (color), TempFoot
 Pavt Mrkg, Wet Reflective, Type NR, Paint, 4 inch, (color), TempFoot

Delete subsection 812.04.N.2, on page 629 of the Standard Specifications for Construction, in its entirety and replace with the following:

2. **Non-Removable (Type NR) Pavement Markings.** The unit price for the relevant **Pavt Mrkg, Wet Reflective, Type NR, Paint, Temp** and **Pavt Mrkg, Type NR, Tape, Temp** pay items include the cost of providing and placing temporary pavement markings.

Delete subsection 812.04.N.3, on page 629 of the Standard Specifications for Construction, in its entirety and replace with the following:

3. **Removable (Type R) Pavement Markings.** The unit prices for **Pavt Mrkg, Wet Reflective, Type R, Tape, 4 inch, (color), Temp** and **Pavt Mrkg Cover, Type R, (color)** include the cost of providing, placing, maintaining, removing and disposing of temporary pavement marking. Payment will be per foot measured along the length of the placed pavement marking except for 8 inch gore markings and double solid lines which will be two times their measured length.

Delete subsection 922.06.A.1 on page 937 of the Standard Specifications for Construction in its entirety and replace with the following:

1. **Pavement Marking, Wet Reflective, Type R.** Provide wet reflective Type R temporary pavement marking as preformed tape. Select wet reflective Type R markings from the Qualified Products List (922.06A). Apply and remove preformed tape in accordance with the manufacturer's instructions. The tape must remain flexible and conform to the texture of the pavement surface during use.

Delete subsection 922.06.A.2, on page 937 of the Standard Specifications for Construction, in its entirety and replace with the following:

2. **Pavement Marking, Wet Reflective, Type NR Paint.** Provide Wet Reflective Type NR temporary pavement markings as paint reflectorized with glass beads and wet

reflective optics, as required.

- a. **Wet Night Retro Reflective Optics.** Select WR optics from one of the following Manufacturers or a Department approved alternative that meets or exceeds the requirements in Table 922-2:

3M Corporation
Potter's Industries
Swarco

Table 922-2 Temporary Wet Reflective Type NR Pavement Markings		
Average Initial Retro reflectivity at 30 meter geometry in mcd/lux/sq m with flow of placement		
Test Method	Color	
	White	Yellow
Dry (<i>ASTM E 1710</i>)	700	500
Wet Recovery (<i>ASTM E 2177</i>)	250	200

Ship the material to the job site or Contractor's yard in sturdy containers marked in accordance with subsection 920.01.A.

Select glass beads for corresponding materials in accordance to subsection 920.02.

Submit to the Engineer prior to the start of work a general certification from the Manufacturer that when applied according to the construction methods herein, the glass beads and optics will meet the minimum requirements shown in Table 922-2.

- b. **Binder Material for Temporary Wet Reflective Type NR Pavement Markings.** Select the liquid applied pavement marking from one of the following materials from the Qualified Products List to use as a binder for the WR optics or use an alternative as approved by the Engineer:

811.03D1 Waterborne, Liquid Pavement Marking Material
811.03D2 Low Temperature Waterborne, Liquid Pavement Marking Material
811.03D3 Regular Dry Paint, Liquid Pavement Marking Material

3. **Pavement Marking, Type NR Tape.** Provide Type NR temporary pavement markings as preformed tape reflectorized with glass beads, as required. The tape must remain flexible and conform to the texture of the pavement surface during use. Select Type NR tape from the Qualified Products List (922.06A).

MICHIGAN
DEPARTMENT OF TRANSPORTATION

SPECIAL PROVISION
FOR
CRUSHED CONCRETE NEAR WATER

CFS:JFS

1 of 1

APPR:KAS:DBP:02-24-12
FHWA:APPR:02-24-12

Add the following paragraph after the first paragraph of Subsection 902.05 on page 743 of the Standard Specifications for Construction:

The use of crushed concrete is prohibited on the project within 100 feet of any water course (stream, river, county drain, etc.) and lake, regardless of the application or location of the water course or lake relative to the project limits.

Add the following paragraph after the first paragraph of Subsection 902.06 on page 743 of the Standard Specifications for Construction:

The use of crushed concrete is prohibited on the project within 100 feet of any water course (stream, river, county drain, etc.) and lake, regardless of the application or location of the water course or lake relative to the project limits.

Add the following paragraph after the fourth paragraph of Subsection 902.07 on page 744 of the Standard Specifications for Construction:

The use of crushed concrete is prohibited on the project within 100 feet of any water course (stream, river, county drain, etc.) and lake, regardless of the application or location of the water course or lake relative to the project limits.

MICHIGAN
DEPARTMENT OF TRANSPORTATION

SPECIAL PROVISION
FOR
ALTERNATIVE GRANULAR MATERIALS FOR FILL AND SUBBASE

CFS:SAB

1 of 1

APPR:JFS:DMG:04-03-12
FHWA:APPR:04-09-12

Delete subsection 902.07.A, on page 744, of the Standard Specifications for Construction, in its entirety and replace with the following:

A. Class I, Class IIAA, or Dense-Graded Aggregate 21A, 21AA and 22A material for Class II material;

Delete subsection 902.07.B, on page 744, of the Standard Specifications for Construction, in its entirety and replace with the following:

B. Class I, Class II, Class IIA, Class IIAA, Class IIIA or Dense-Graded Aggregate 21A, 21AA and 22A material for Class III material;

Delete subsection 902.07.C, on page 744, of the Standard Specifications for Construction, in its entirety and replace with the following:

C. Class I material for Class IIAA material; and

Add the following subsection to Section 902.07, on page 744, of the Standard Specifications for Construction.

D. Dense-Graded Aggregate 21A, 21AA and 22A material for Class IIA.

MICHIGAN
DEPARTMENT OF TRANSPORTATION

SPECIAL PROVISION
FOR
SUPERPAVE FINAL AGGREGATE BLEND REQUIREMENTS

CFS:KPK

1 of 2

APPR:JFS:CJB:04-03-15

FHWA:APPR:04-07-15

a. Description. This special provision establishes the Superpave final aggregate blend gradation requirements and the Superpave final aggregate blend physical requirements.

b. Materials. Replace Table 902-5 and Table 902-6 of the Standard Specifications for Construction with the following tables.

Table 902-5						
Superpave Final Aggregate Blend Gradation Requirements						
Standard Sieve	Percent Passing Criteria (control points)					
	Mixture Number					
	5	4	3 Leveling Course	3 Base Course	2	LVSP (a)
1½ inch	—	—	—	—	100	—
1 inch	—	—	100	100	90–100	—
¾ inch	—	100	90–100	90–100	≤90	100
½ inch	100	90–100	≤90	≤90	—	75–95
⅜ inch	90–100	≤90	—	—	—	60–90
No. 4	≤90	—	—	—	—	45–80
No. 8	47-67	39-58	35-49	23-49	19-45	30-65
No. 16	—	—	—	—	—	20-50
No. 30	—	—	—	—	—	15-40
No. 50	—	—	—	—	—	10-25
No. 100	—	—	—	—	—	5-15
No. 200	2.0–10.0	2.0–10.0	2.0–8.0	2.0–8.0	1.0–7.0	3–6
a. For LVSP, less than 50 percent of the material passing the No. 4 sieve may pass the No. 30 sieve.						

**Table 902-6
Superpave Final Aggregate Blend Physical Requirements**

Est. Traffic (million ESAL)	Mix Type	Percent Crushed Minimum Criteria		Fine Aggregate Angularity Minimum Criteria		% Sand Equivalent Minimum Criteria		Los Angeles Abrasion % Loss Maximum Criteria		% Soft Particles Maximum Criteria (a)		% Flat and Elongated Particles Maximum Criteria (b)	
		Top & Leveling Courses	Base Course	Top & Leveling Courses	Base Course	Top & Leveling Courses	Base Course	Top & Leveling Courses	Base Course	Top & Leveling Courses	Base Course	Top & Leveling Courses	Base Course
< 0.3	LVSP	55/—	—	—	—	40	40	45	45	10	10	—	—
< 0.3	E03	55/—	—	—	—	40	40	45	45	10	10	—	—
≥0.3 - <1.0	E1	65/—	—	40	—	40	40	40	45	10	10	—	—
≥1.0 - < 3	E3	75/—	50/—	43	40	40	40	35	40	5	5	10	10
≥3 - <10	E10	85/80	60/—	45	40	45	45	35	40	5	5	10	10
≥10 - <30	E30	95/90	80/75	45	40	45	45	35	35	3	4.5	10	10
≥30 - <100	E50	100/100	95/90	45	45	50	50	35	35	3	4.5	10	10

(a) Soft particles maximum is the sum of the shale, siltstone, ochre, coal, clay-ironstone and particles that are structurally weak or are non-durable in service.
(b) Maximum by weight with a 1 to 5 aspect ratio.

Note: "85/80" denotes that 85 percent of the coarse aggregate has one fractured face and 80 percent has at least two fractured faces.

MICHIGAN
DEPARTMENT OF TRANSPORTATION

SPECIAL PROVISION
FOR
PHYSICAL REQUIREMENTS FOR GEOTEXTILES

CFS:RBE

1 of 1

APPR:DMG:RWS:08-06-15

FHWA:APPR:08-11-15

Delete Table 910-1 on page 813 of the Standard Specifications for Construction in its entirety and replace with the following:

Table 910-1: Physical Requirements for Geotextiles

Geotextile Category	Property				
	Grab Tensile Strength (minimum) (pounds)	Trapezoid Tear Strength (minimum) (pounds)	CBR Puncture Strength (minimum) (pounds)	Permittivity per second (minimum)	Apparent Opening Size (maximum) (millimeters)
	Test Method				
	<i>ASTM D 4632</i>	<i>ASTM D 4533</i>	<i>ASTM D 6241</i>	<i>ASTM D 4491</i>	<i>ASTM D 4751</i>
Geotextile Blanket (a)	90	45	230	0.5	0.21
Geotextile Liner	200	75	440	0.5	0.21
Heavy Geotextile Liner	270	100	620	0.5	0.21
Woven Geotextile Separator (<50% elongation)	270	100	620	0.05	0.425
Non-Woven Geotextile Separator (>50% elongation)	200	75	440	0.05	0.425
Stabilization Geotextile	270	100	620	0.05	0.50
Silt Fence	100 (b)	45	---	0.1	0.60
Drainage Geocomposites	90	45	230	0.5	0.21
<p>a. For pipe wrap where backfill around the pipe meets granular material Class IIAA requirements; geotextiles, including knitted polyester sock, which meet the following minimum requirements in the applied condition are permitted: Mass/Unit Area: 3.0 oz/yd²; Mullen burst strength: 100 psi; maximum apparent opening size must be 0.30 mm for pavement and foundation underdrains, and 0.60 mm in other areas. The fluid displacement rate for the Mullen burst test equipment must be 170 mL/min ±5 mL/min. Subtract tare strength from the ultimate burst strength as specified in <i>ASTM D 3786</i>.</p> <p>b. Elongation at the specified grab tensile strength no greater than 40% for silt fence.</p>					

MICHIGAN
DEPARTMENT OF TRANSPORTATION

SPECIAL PROVISION
FOR
ELECTRICAL AND LIGHTING CONDUIT

UTL:SJU

1 of 1

APPR:MWB:LWB:01-13-15
FHWA:APPR:01-27-15

Delete the first sentence in subsection 918.01, on page 857 of the Standard Specifications for Construction, and replace with the following:

Provide conduits listed and appropriately labeled by a Nationally Recognized Testing Laboratory (NRTL), as recognized by the Occupational Safety and Health Administration (OSHA), with ultraviolet protection and manufactured for use at temperatures of at least 194 degrees F unless otherwise required.

Delete the second sentence in subsection 918.01.A, on page 857 of the Standard Specifications for Construction, and replace with the following:

Provide galvanized steel conduit manufactured in accordance with UL 6.

MICHIGAN
DEPARTMENT OF TRANSPORTATION

SPECIAL PROVISION
FOR
PERMANENT PAVEMENT MARKING MATERIALS

PMK:MKB

1 of 1

APPR:MWB:CRB:07-07-16
FHWA:APPR:07-13-16

Delete the first paragraph of subsection 920.01, on page 890 of the 2012 Standard Specifications for Construction in its entirety and replace it with the following:

Select pavement marking materials from the Qualified Products List unless specified otherwise by special provision in the contract. For black liquid shadow markings and blue markings used in parking areas, either choose a product of the specified binder material and color from the Qualified Products List or select a white product of the specified binder material from the Qualified Products List and tint the product to the appropriate color.

Use liquid applied pavement marking materials manufactured in the previous 12 months or within the shelf-life directed by the manufacturer, whichever is less. Use solid applied materials within the shelf-life directed by the manufacturer. Provide certification that liquid and solid applied pavement marking materials have been stored per the manufacturer's requirements. Materials not in compliance will be rejected and removed at the Contractor's expense.

Delete the second paragraph from subsection 920.02.A, on page 891 of the Standard Specifications for Construction in its entirety and replace it with the following:

Glass beads must meet the general requirements of subsection 920.02.B, and the applicable requirements for specific applications of subsection 920.02.C. All glass beads meeting subsections 920.02.B and 920.02.C to be used on Federal-aid projects must contain no more than 200 parts per million of arsenic or lead, as determined in accordance with *Environmental Protection Agency* testing methods 3052, 6010B, or 6010C.

Add the following after the last paragraph of subsection 920.02.C, on page 892 of the 2012 Standard Specifications for Construction:

6. **Modified Urethane.** The type, gradation, and application rates for glass beads used with modified urethane marking material must meet the modified urethane manufacturer's recommendation.

Use a double drop system of large and standard glass beads, a double drop system of ceramic elements and standard glass beads, or an Engineer-approved alternate for recessed longitudinal markings. Ensure large glass beads meet federal specification TTB-1325 for a Type 4 glass bead.

MICHIGAN
DEPARTMENT OF TRANSPORTATION

SPECIAL PROVISION
FOR
GLASS BEADS USED FOR PAVEMENT MARKINGS

PMK:MKB

1 of 1

APPR:MWB:HZ:10-26-12
FHWA:APPR:11-05-12

Delete the second paragraph from subsection 920.02.A, on page 891 of the Standard Specifications for Construction in its entirety and replace it with the following:

Glass beads must meet the general requirements of subsection 920.02.B, and the applicable requirements for specific applications of subsection 920.02.C. All glass beads meeting subsections 920.02.B and 920.02.C to be used on Federal-aid projects must contain no more than 200 parts per million of arsenic or lead, as determined in accordance with *Environmental Protection Agency* testing methods 3052, 6010B, or 6010C.

MICHIGAN
DEPARTMENT OF TRANSPORTATION

SUPPLEMENTAL SPECIFICATION
FOR
ERRATA TO THE 2012 STANDARD SPECIFICATIONS

1 of 29

07-29-16

Page	Subsection	Errata
3	101.02	Modify the abbreviation reading "AIS" to read "AIS1".
4	101.02	Delete the following abbreviations and the long forms MDELEG MDNRE Add the following abbreviations and the long forms MDNR Michigan Department of Natural Resources MDEQ Michigan Department of Environmental Quality MDLARA Michigan Department of Licensing and Regulatory Affairs NESC National Electrical Safety Code
27	103.02.B.2	Change the last sentence of the first paragraph to read "For decreases below 75 percent, the maximum allowable payment for work performed, including any adjustment, will not exceed an amount equal to 75 percent of the original contract quantity times the contract unit price."
34	104.05	The first sentence of this subsection should read "If the Contractor performs unauthorized work (work performed without the inspections required by the contract, extra work performed without Department approval, work performed contrary to the inspectors direction, or work performed while under suspension by the inspector), the Engineer may reject the unauthorized work."
46	104.12	Add the following to the end of the first paragraph "The use of right-of-way in wetlands and floodplains, or the crossing of water courses by construction equipment is prohibited."
53	105.09	Add the following to the end of the second paragraph "Any specifically produced material not purchased by the Department, will remain the Contractors and must be removed from the project prior to final acceptance."
56	107.02.B.2	This sentence should read "U.S.Army Corps of Engineers' Section 404, Dredge and Fill; and Section 10, Navigable Waterway."
56	107.02.B	Add the subsection reading as follows: "3. U.S. Coast Guard Section 9, Navigable Waterway." Change "MDNRE" to "MDEQ" in this subsection.

Page	Subsection	Errata		
64	107.12	Change the first sentence of the first paragraph to read: "For protection of underground utilities and in accordance with 2013 PA 174, the Contractor must notify Miss Dig at least 3 work days, excluding Saturdays, Sundays and holidays, before beginning each excavation in areas where public utilities have not been previously located."		
65	107.15.A	Change "MDNRE" to "MDEQ" in four instances in this subsection.		
66	107.15.A.3	Add the following to the end of the paragraph "Note that a burn permit from the MDNR is required for any open burning whenever the ground is not snow covered. Any individuals that allow a fire to escape will be in violation of the Natural Resources and Environmental Protection Act and will be required to reimburse the costs of suppressing the wild fire."		
67*	107.16	The third sentence should read "In State Forests, the Contractor must contact the local Unit Manager, Forest Management Division, MDNR, regarding the work to be performed within or adjacent to the forest land." Delete the last sentence of the first paragraph of this subsection.		
80	108.08.F	Delete the second paragraph in its entirety.		
80	108.08.G	Add the following new subsection: "G. The Contractor may propose and the Engineer may approve another equitable method, supported by an acceptable rationale to determine time extensions for any of the excusable delays listed in subsection 108.08.		
83	108.10.C	Change the last sentence of the first paragraph to read: "The liquidated damages may contain one or more components of damages added together."		
83	108.10.C.1	In Table 108-1 delete the last row of the table and replace it with the following: <table border="1" style="margin-left: 40px;"> <tr> <td style="padding: 2px;">≥50,000,000</td> <td style="padding: 2px;">4,500</td> </tr> </table>	≥50,000,000	4,500
≥50,000,000	4,500			
102	109.05.E.1	Change the second sentence of the third paragraph to read: "Provide the content specified in subsection 109.05.D.11 for the applicable items in this statement and as follows:"		
107	150.04	Change the following pay item reading "Mobilization, Max ___" to read "Mobilization, Max (dollar)" at nine locations throughout the subsection.		
112	201.03.A.3.b	Change "MDNRE" to "MDNR" in three instances in this subsection.		
150	208.01	Change "MDNRE" to "MDEQ" in this subsection.		
180	308.03.A	Change the first sentence of the second paragraph to read:		

Page	Subsection	Errata
		"Do not operate equipment required to place backfill directly on geotextile products."
185	401.03.A	Change the first sentence of the second paragraph to read: Where unstable soil conditions, or obstructions other than rock, require excavation of the trench below the elevation detailed on the plans; undercut, backfill, and compact the trench as directed by the Engineer.
188	401.03.H	Change the second sentence of the paragraph to read "Jack steel pipes in place in accordance with subsection 401.03.G".
189	401.03.N	Add the following sentence to the end of the first paragraph "Where possible, maintain the stream flow thru a temporary channel or temporary culvert." The second sentence of the second paragraph should read "Direct water from the dewatering operations through a filter bag before discharging to an existing drainage facility."
190	401.04	Change the fourth pay item from the end of the list to read as follows: "Steel Casing Pipe, __ inch, Tr Det __."
195	402.03.C	Change the third sentence of the first paragraph to read as follows: "Wrap pipe joints, with a diameter greater than 24 inches, using geotextile blanket."
200	402.04	Change the third pay item from the top of the list to read as follows: "Sewer, CI __, __ inch, Jacked in Place"
200	402.04.A	Change the last sentence of the subsection to read as follows: "The unit price for Sewer and Sewer, Reinf Conc, Ellip includes the cost of excavation, backfill, geotextile blanket and mandrel testing."
201*	402.04.H	Change the last sentence of the first paragraph to read "The Department will not make an adjustment in the pay items of Minor Traf Devices or Traf Regulator Control ."
208	403.04.D.3	Change the sentence to read: "Removing and replacing pavement adjacent to the adjusted cover per Standard Plan R-37 Series."
218	406.03.A.2	Change the first sentence of the first paragraph to read: "Design precast box culverts less than 10 feet in span length measured along the centerline of the roadway in accordance with current AASHTO LRFD Bridge Design Specifications and ASTM C 1577." Add the following sentence to the end of the first paragraph: "Design precast box culverts greater than or equal to 10 feet in span length measured along the centerline of the roadway for HL-93 Modified live load."

Page	Subsection	Errata
219	406.03.B	Change the first sentence of the first paragraph to read: “Submit shop drawings for culverts greater than or equal to 10 feet in span length measured along the centerline of the roadway to the Engineer, for review and approval in accordance with subsection 104.02.”
219	406.03.C.1	Change the second sentence of the first paragraph to read: “Before manufacture, perform load ratings on precast three-sided, arch or box culverts greater than or equal to 10 feet in span length measured along the centerline of the roadway, in accordance with the AASHTO Manual of Bridge Evaluation, Section 6, Part A, the Michigan Bridge Analysis Guide current at the time load rating is performed, and the Michigan Structure Inventory and Appraisal Guide.”
223	406.03.G	Add the following after the first sentence of the second paragraph: “Where possible, maintain the stream flow thru the existing channel, temporary channel, or temporary culvert.”
224	406.03.G	Replace the fifth paragraph of this subsection with the following: “The Contractor may use cast-in-place wing walls, headwalls, and aprons, as alternatives to precast wing walls, headwalls, and aprons. Attach cast-in-place wing walls or headwalls as shown on the shop drawings.”
225	406.03.G.2	Change the third sentence of the first paragraph to read: “Before placing the open-graded aggregate 34R, compact the coarse aggregate 6A using at least three passes of a vibrating plate compactor.”
226	406.03.G.2	Change the first sentence of the second paragraph of this subsection to read: “Fill the space between the box culvert joints during placement of box sections with closed-cell rubber extrusion type gaskets in accordance with ASTM C 990.”
226	406.04.A.9	Change the sentence to read: “Providing plan modifications including design, additional plan quantities and pay items to accommodate any changes to the precast units as shown on the plans.”
226*	406.04.A	Add the following paragraph after the last paragraph of the subsection: “The substructure design is specific to the three-sided or arch culvert detailed on the plans. The Contractor must use approved MDOT service vendors qualified in Hydraulics, Geotechnical Engineering Services, and Short and Medium Span Bridges to perform the required design and plan modifications, as directed by the Engineer, if the Contractor selects a culvert shape different than shown on the plans.”
227	406.04.B	Add the following new item in the list of items in this subsection:

Page	Subsection	Errata
		<p>2. Headwalls, wingwalls, aprons, and curtain walls, precast or cast-in-place;</p> <p>Renumber the exist items 2 through 4 in this list to read 3 through 5.</p> <p>Delete existing item numbered 5 and replace with the following:</p> <p>6. Inserts for bars and connection hardware; and</p> <p>Renumber the existing item 6 in this list to read 7.</p>
227	406.04.B	<p>Delete the first and second paragraphs following the list of items in this subsection and replace with the following: “The Department will pay separately for cast-in-place concrete, other than for culvert segments, wing walls, and headwalls; excavation; protective coating; providing and placing backfill material; by plan quantity in accordance with subsection 109.01.A.”</p>
239	501.03.C.6	<p>The first sentence of this subsection should read "Except as specified in subsection 501.03.C.4, removing HMA surface applies to removing HMA overlying a material designated for removal or that is required to remain in place."</p>
247	501.03.O	<p>Change footnote e in Table 501-5 to read: "Flushing severe enough to significantly affect surface friction (Friction Number <35)."</p>
249	501.04.H	<p>The first sentence of this subsection should read "The Engineer will measure, and the Department will pay for removing HMA surface, no greater than 12 inches thick, overlying a material designated for removal or that is required to remain in place, as HMA Surface, Rem."</p> <p>The second paragraph of this subsection should read "The Engineer will measure, and the Department will pay for removing HMA surface, greater than 12 inches thick, overlying a material designated for removal or that is required to remain in place, as Pavt, Rem in accordance with subsection 204.04."</p>
257	503.03.E	<p>Delete this subsection in its entirety.</p>
265	504.03.E.3	<p>Delete this subsection in its entirety.</p>
269	504.04.A	<p>This subsection should read "The unit prices for Micro-Surface, regardless of the type required, include cleaning existing pavement; applying a bond coat; temporary pavement markings; stationing; corrective action; and traffic control to complete corrective action."</p>
299	601.04	<p>In table 601-2 delete the row for Grade P-NC concrete in its entirety.</p>
300	601.04	<p>In table 601-2, the first sentence of footnote b. should read: “Use coarse aggregate 6A, 6AA or 6AAA for Grades P1, P2 and M.”</p>

Page	Subsection	Errata
		In table 601-2, footnote c. should read: "The mix design basis for bulk volume (dry, loose) of course aggregate per unit volume of concrete is 72% for Grade P1; 74% for Grade P2."
308	602.03.F	Note c. in Table 602-1 should read "Refer to Section D6 of the Materials Quality Assurance Procedures Manual for inspection procedure."
320	602.04.C.3	The last paragraph in this subsection should read "If the Engineer approves a substitution of a higher concrete grade for a lesser grade (e.g., P1 for P2), the Department will pay for the higher grade of concrete using the original bid and pay items of the lesser grade."
327	603.02	Change the second material in the list to read: "Concrete, Grade P-NC.....603" Change the third material in the list to read: "Base Course Aggregate, 4G, 21AA, 22A.....902"
334	603.03.B.10	Change the last sentence of the second paragraph to read "Apply the required curing compound in two coats, at a rate of at least 1 gallon per 25 square yards for each coat."
342	603.04.G.3	Change "D1" to "W" in two instances in this subsection.
351	701.04	Replace Tables 701-1A and 701-1B with the Table 701-1 below.
372	705.03.C.1	Add the following sentence after the first paragraph of this subsection: "Do not drive piles within a radius of 25 feet of newly placed concrete until the concrete attains at least 75 percent of its specified minimum strength."
374	705.03.C.2.c	Change the last sentence of the second paragraph to read "Drive test piles to the minimum pile length or practical refusal, whichever is greater".
379	705.04	Change the fifth item down the list to read: "Pile, Galv (Structure No.)"
380	705.04	Change the last item in the list to read: "Pile Driving Equipment, Furn (Structure No.)"
383	706.02	The fourth paragraph following the list of materials should read "Provide AASHTO M 270, Grade 36 steel, meeting the requirements of ASTM A 786, galvanized in accordance with section 707, for expansion joint cover plates. Provide plates at least 3/8 inch thick. Use plates with a slip resistance equal to or greater than those meeting the requirements of ASTM A 786 and must be approved by the Engineer. Provide ASTM F 593 (Type 304) stainless steel, 3/4-inch or 1/2-inch diameter, flathead

Page	Subsection	Errata
		countersunk screws with 3/4-inch or 1/2-inch diameter inserts for use in expansion joint cover plates."
389	706.03.D.4.b	Change the first sentence of the fourth paragraph to read "Design forms, form supports, and attachments to carry dead loads, and resultant horizontal loads due to forming of cantilever overhangs."
390	706.03.E.4	Change the forth sentence of the first paragraph to read: "Use wire ties to secure all bar intersections for the top mat. Use wire ties to secure all bar intersections for other mats where the product of the length and width of bar intersection spacing exceeds 120 square inches."
391	706.03.E.8	Change the first sentence of the second paragraph of this subsection to read: "Patch sawed or sheared ends and visible defects in accordance with ASTM A 775."
392	706.03.E.8	Change the last sentence of the third paragraph of this subsection to read: "Coat mechanical splices after splice installation in accordance with ASTM A 775 for patching damaged epoxy coating."
394	706.03.H.1	Delete the last paragraph on page 394 and replace it with the following: "Do not cast sidewalk, curb, or barrier pours until the deck concrete attains at least the minimum specified 7-day flexural or compressive strength, and after completion of the 7-day continuous wet cure. The forming of succeeding portions may occur, provided the wet cure is maintained."
406*	706.03.N.1.b	Add the following to the end of the last paragraph of the subsection: "Do not discontinue wet cure nor cast succeeding portions onto the bridge deck prior to completion of the 7-day two-phase continuous wet cure. Ensure excess or ponding cure water is removed prior to casting of succeeding structure portions."
416	707.03.C.1	Change the title of the subsection from "Shop Plans to read "Shop Drawings". Change the second sentence of this subsection to read: "Do not use design drawings in lieu of shop drawings."
426	707.03.C.17	Change the second sentence in the first paragraph of this subsection to read: "Tap oversized galvanized nuts in accordance with ASTM A 563 or AASHTO M 292 and meet Supplementary Requirement S1 of ASTM A 563 or AASHTO M 292."
430	707.03.D.7.b	Delete the first sentence of the last paragraph of this subsection.

Page	Subsection	Errata
430*	707.03.D.7.b	Change the title of the Table 707-4 to read: "Minimum Bolt Tension for ASTM A 325 Bolts"
430	707.03.D.7.b	Change "104,000" to "103,000" in the last row under the column titled Minimum Bolt Tension.
431	707.03.D.7.c	Add the following sentence to the end of the first paragraph of this subsection: "If using impact wrenches, provide wrenches sufficient to tighten each bolt in approximately 10 seconds."
431*	707.03.D.7.c	Change the first sentence of the second paragraph to read: "Do not reuse ASTM A 325 bolts and nuts."
434	707.04.A	Change the first sentence of the first paragraph of this subsection to read: "The Engineer will measure structural steel by the calculated weight of metal in the finished structure, excluding filler metal in welding, as shown on the shop drawings or working drawings."
438	708.03.A.2	Change the title of the subsection from "Shop Plans to read "Shop Drawings". Change the first sentence to read: "Submit shop drawings in accordance with subsection 104.02." Change the fourth sentence to read: "Do not start production until the Engineer approves the shop drawings."
441*	708.03.A.11	Change the last sentence of the first paragraph to read "Cure concrete at temperatures from 70 °F to 150 °F until concrete attains the release strength shown on the shop drawings".
441	708.03.A.11	Change the fourth sentence of the fourth paragraph to read "Do not exceed a maximum concrete temperature of 150 °F during the curing cycle."
458	711.03.A	Change the first sentence in the first paragraph to read: "Shop drawings for structural steel and pipe railings are not required."
460	711.04.A	Change the second sentence of the first paragraph to read: "The unit price for Bridge Barrier Railing includes the cost of placing steel reinforcement, providing and placing concrete, constructing joints, and forming, finishing, curing and protecting the concrete."
461	711.04.F	The title of this subsection should read " Reflective Marker, Permanent Barrier. "
467	712.03.C	Add the following to the end of the third paragraph of the subsection:

Page	Subsection	Errata
		<p>“Notify the Engineer of any saw cuts in the top flange. Saw cuts equal to or less than 1/32 inch deep in steel beams must be repaired by grinding, to a surface roughness no greater than 125 micro-inches per inch rms, and tapering to the original surface using a 1:10 slope. Saw cuts in excess of 1/32 inch deep in steel beams require a welded repair to be submitted to the Engineer for approval. Weld in accordance with subsection 707.03.D.8 and provide adequate notice to allow the Engineer to witness the repair work. Inspect and test all saw cut repairs (including grinding repairs) using ultrasonic testing in accordance with 707.03.D.8.c at no additional cost to the Department.”</p>
471	712.03.J	<p>Add the following to the end of the second paragraph of the subsection: “Select adhesive anchor systems from the Qualified Products List.”</p>
471	712.03.J.1	<p>Delete the first paragraph in this subsection and replace it with the following: “Propose complete details of drilling, cleaning, and bonding systems for anchoring reinforcement and submit for the Engineer’s approval before use. The minimum embedment depth must be nine times the anchor diameter for threaded rod or bolt and twelve times the anchor diameter for reinforcing bar. Propose a drilling method that does not cut or damage existing reinforcing steel. Prepare at least three proof tests per anchor diameter and type in the same orientation in which they will be installed on the existing structure, on a separate concrete block, in the presence of the Engineer. The Engineer will proof test the proposed systems. The Engineer will base approval of the anchoring system on the following criteria:”</p>
471	712.03.J.2	<p>Change the third sentence of the first paragraph to read: “Use a tension testing device for unconfined testing, in accordance with ASTM E 488.”</p>
473	712.03.L.2	<p>Change the first sentence in the second paragraph of this subsection to read: “If using epoxy coated steel reinforcement, epoxy coat mechanical reinforcement splices in accordance with ASTM A 775.”</p>
473	712.03.L.3	<p>Delete the existing first sentence in the first paragraph.</p>
473	712.03.L.3	<p>Change the third sentence of the first paragraph to read “Provide two test splices on the largest bar size.”</p>
473*	712.03.L.3	<p>Change the sentence beginning “Demonstrate to the.... to read: “Demonstrate to the Engineer that splices have a tensile strength of 125 percent of the bar yield strength and high strength splices have a tensile strength of 150 percent of the bar yield strength.”</p>
488	713.02	<p>Add the following as subsection 713.02.C: “C. Structural Steel for Retrofitting and Welded Repairs. Structural steel material used for retrofitting and welded repairs of primary</p>

Page	Subsection	Errata
		members as defined in subsection 707.01.B must meet longitudinal Charpy V-Notch impact test requirements."
501	715.02	Add the following material reference above the two existing items: "Sealant for Perimeter of Beam Plates713"
508	715.03.D.1	Add the following sentence after the second paragraph of the subsection: "Apply sealant for perimeter of beam plates in accordance with subsection 713.03.F."
515	716.03.A	Delete the second paragraph of this subsection in its entirety. Change the last sentence of the last paragraph of this subsection to read: "Provide a primer dry film thickness for the top flange between 4 mils and 10 mils."
519	716.04	Change the second sentence of the first paragraph of this subsection to read: "The unit price for Field Repair of Damaged Coating (Structure No.) includes the costs of making field repairs to the shop applied coating system; prime coat surfaces and exposed surfaces of bolts, nuts, and washers; and repairing stenciling."
521	717.04.B	This subsection should read "The unit price for Drain Casting Assembly includes the cost of providing and installing the downspout and, if necessary, the lower bracket to the drain casting."
522	718.02	Change the section number "906" in the third material in the list to read "919."
533	718.04	Delete the following pay item from the list: Temp CasingFoot
533	718.04.B.2	Delete this subsection in its entirety.
533	718.04.B.3	Renummer this subsection as follows: "2. Permanent Casing. "
540	802.04	Change "Non reinf" in the last pay item of the list with "Nonreinf".
545*	803.04.E	Change the second sentence of the second paragraph to read: "The unit price for Railing for Steps includes the cost of providing, fabricating, installing, and grouting the railing."
560	807.04	Delete the following pay item from the list: Guardrail Buffered EndEach
560	807.04.B	Change the fifth paragraph of this subsection to read:

Page	Subsection	Errata
		"The Engineer will measure Guardrail Salv and Guardrail, Mult, Salv along the face of the rail (one face for multiple beams), including terminals and end shoes."
567	808.04.C	Change the first paragraph of this subsection to read: "The Department will not pay separately for protective fence required in accordance with subsection 104.07."
569	809.04.A	Change the first sentence to read: "The unit price for Field Office, CI ___ includes the cost of setup, providing access, grading, maintaining, plowing snow, and utility hook-up charges."
570	809.04.B	Delete the existing second and third sentences in the first paragraph and replace them with the following: "The unit price for Field Office, Utility Fees includes the cost of monthly usage fees for electricity, gas, telephone service and charges, fuel for the stove, monthly water and sanitary service."
570	809.04.B	Change the existing fourth sentence in the first paragraph to read: "The Department will reimburse the Contractor for monthly usage fees for electricity, gas, telephone, water and sanitary charges incurred by the Department."
575	810.03.K	Change the subsection to read "K. Drilled Piles for Cantilever and Truss Foundations. Construct drilled piles for cantilever and truss foundations in accordance with section 718."
578	810.03.N.2	Add the following sentence after the first sentence of the second paragraph on this page: "Mark each nut and bolt to reference the required rotation."
584	810.04	Delete the last pay item in the list: Truss Fdn Anchor Bolts, Replace.....Each
596	811.03.G	Delete this subsection in its entirety.
597*	811.03.H	Rename this subsection as follows: "G. Raised Pavement Marker (RPM) Removal. "
597*	811.04	Change "Crosshatching" in the last pay item of the list on this page to "Cross Hatching".
598*	811.04	Delete the following pay items from the list: Pavt Mrkg, (material), 4 inch, SRSM, (color).....Foot Pavt Mrkg, (material), 4 inch, SRSM, 2 nd Application, (color).....Foot Add the following pay items to the list: "Pavt Mrkg, Polyurea, (legend).....Each

Page	Subsection	Errata
		Pavt Mrkg, Polyurea, (symbol).....Each”
		Change the sixth item down the list to read: “Pavt Mrkg, Polyurea, __ inch, Cross Hatching, (color)”
		Change the eleventh item down the list to read: “Rem Curing Compound, for Longit Mrkg, __ inch.....Foot”
		Change the last item in the list to read: “Witness, Log, Layout, \$1000.00”
599	811.04.B	Delete this subsection in its entirety.
599	811.04	Rename the following subsections as follows: “B. Call Back. C. Pavement Marking Removal. D. Material Deficiency. ”
602	812.03.D	Change the first sentence to read "Provide and maintain traffic control devices meeting the requirements in the ATSSA Quality Guidelines for Work Zone Traffic Control Devices and Features."
603	812.03.D.1	The last sentence on this page should read "Lay the sign behind the guardrail, with the uprights pointing downstream from the traffic, and place the support stands and ballasts close to the guardrail."
604	812.03.D.2	The first sentence of the fourth paragraph should read "Do not use burlap or similar material to cover Department or Local Government owned signs."
604	812.03.D.5	The fifth sentence of the first paragraph should read "Do not mix drums and cones within a traffic channeling sequence."
605	812.03.D.6.b	Change the first sentence of the first paragraph to read: “The Department will allow the nighttime use of 42-inch channelizing devices, in the tangent area only, on CPM and pavement marking of any duration where the use of plastic drums restricts proposed lane widths to less than 11 feet, including shy distance.”
605	812.03.D.7	Add the following sentence after the first sentence of the first paragraph: “Place a shoulder closure taper in advance of the lighted arrows placed on the shoulders.”
607	812.03.D.9	Delete the second paragraph of this subsection and replace with the following: “Link sections together to fully engage the connection between sections. Maintain the barrier with end-attachments engaged and within 2 inches of the alignment shown on the plans.”
608	812.03.D.10.b	Delete the second sentence of the second paragraph of this subsection beginning with "Install sand module attenuators..."

Page	Subsection	Errata
608	812.03.D.10.b	Add the following sentence after the second paragraph of this subsection: "Install impact attenuation devices as shown on the plans, as directed by the Engineer, or both."
609	812.03.D.10.e	Delete the second paragraph of this subsection.
613	812.03.D.14.a.iii	Change the sentence in this subsection to read "Place an ET Type or SKT Type extruder guardrail ending on both blunt guardrail ends."
615	812.03.F	The second sentence of the second paragraph of this subsection should read: "The Contractor may use a Type R temporary pavement marking cover, per subsection 812.03.D.12 when authorized by the Engineer."
616	812.03.F.2	The last sentence of the first paragraph should read: "If the removal equipment cannot collect all removal debris, operate a self-propelled sweeper capable of continuously vacuuming up the removal debris immediately behind the removal equipment."
617	812.03.G.3	The first sentence of the second paragraph should read: "Sweep the shoulder and remove debris prior to placing traffic on the shoulder and throughout the time the shoulder is used to maintain traffic."
617	812.03.G.4.a	Delete "48 inch by 48 inch" from the first sentence of this subsection.
618*	812.03.G.7	The first sentence of the first paragraph should read: "Clean barrier reflectors, plastic drums, 42 inch channelizing devices, tubular markers, signs, barricades, and attached lights in operation on the project to ensure they meet required luminosity."
619	812.03.G.8	The second sentence of the third paragraph from the end of the subsection should read: "Illuminate traffic regulator stations at night per subsection 812.03.H."
621	812.03.I.6	Delete "48 inch by 48 inch" from the second sentence of this subsection.
622*	812.03.J	The second paragraph should read "Apply one 2-inch wide horizontal stripe of red and white conspicuity tape along at least 50 percent of each side of, and across the full width of the rear of the vehicle or equipment."
622	812.04	Change the second item down the list to read: "Traf Regulator Control" Change the sixth item down the list to read: "Sign Cover, Type I"
626	812.04.I	Change the reference "812.04.E" in the first sentence to "812.04.D".
628	812.04.M.4	Add the following as the first sentence of this subsection:

Page	Subsection	Errata
		"The Engineer will not measure a temporary barrier ending move as Conc Barrier Ending, Temp, Relocated if it involves work defined in subsection 812.04.M.3."
629	812.04.N.1	Change the reference "811.04.D" in the second paragraph of this subsection to read "811.04.C".
630	812.04.S	Change the first sentence to read: "The Department will not make additional payments for traffic regulating, signing, arrow boards, and lighting systems for traffic regulator stations operated at night due to a temporary PTS system failure."
634	813.03.C.3	Change the reference "903.07.A" in the paragraph of this subsection to read "907.07.B".
646	815.04	Change the first, third and fourth pay items in the list to read: "Site Preparation, Max (dollar) Lump Sum Watering and Cultivating, First Season, Min (dollar)..... Lump Sum Watering and Cultivating, Second Season, Min (dollar) Lump Sum"
646	815.04.C.1	Change the following pay item reading: "Watering and Cultivating, First Season, Min. (dollar)" to read "Watering and Cultivating, First Season, Min (dollar)" at two locations throughout the subsection.
646	815.04.C.1.b	Delete this subsection in its entirety.
646	815.04.C.1.c	Rename this subsection to read: "b. Removal and disposal of unacceptable plants."
646	815.04.C.2	Change the following pay item reading: "Watering and Cultivating, Second Season, Min. (dollar)" to read "Watering and Cultivating, Second Season, Min (dollar)" at three locations throughout the subsection.
647	815.04.C.2	Change the last paragraph of this subsection to read: "For each unacceptable plant identified, the Engineer will calculate a 50 percent reduction in the unit price for the relevant (Botanical Name) pay item, and will process a negative assessment for each unacceptable plant for that amount."
650	816.03.B	Delete the first paragraph of this subsection and replace with the following: "Conduct soil tests when called for in the contract or when directed by the Engineer. Provide soils tests results to the Engineer when testing is required. Provide and place fertilizer as indicated below and as indicated in the soils tests, if required."
650	816.03.B.1	Change the sentence to read: "For Class A fertilizer, evenly apply 176 pounds of chemical fertilizer nutrient per acre on a prepared seed bed."

Page	Subsection	Errata
650	816.03.B.2	Change the sentence to read: "For Class B fertilizer, evenly apply 120 pounds of chemical fertilizer nutrient per acre on a prepared seed bed."
650*	816.03.B.3	Change the sentence to read: "For Class C fertilizer, evenly apply 80 pounds of chemical fertilizer nutrient per acre on established turf."
663*	819.01	<p>Delete the first paragraph in the subsection and replace it with the following:</p> <p>"This work consists of providing operating electrical and lighting units; removing, salvaging, or disposing of existing electrical and lighting components; excavating, backfilling, restoring the site in accordance with section 816; and disposing of waste excavated materials. Complete this work in accordance with this section, section 820, and the contract and to the requirements of the NEC, the National Electrical Safety Code, and the MDLARA for those items not identified in the contract."</p> <p>Change the third sentence of the second paragraph in this subsection to read:</p> <p>"Contact the MDLARA for electrical service inspection and pay the applicable fees."</p>
671	819.03.F.1	<p>Change the paragraph to read:</p> <p>"Install light standard foundations as shown on the plans and the standard plans, as applicable."</p>
673	819.03.G.4.b	<p>Change the last sentence of the first paragraph to read:</p> <p>"Tighten the anchor bolts to a snug tight condition as described in the third paragraph of subsection 810.03.N.2 ensuring the lock washer is completely compressed."</p>
673	819.03.G.4.b	<p>Delete the first two sentences of the second paragraph and replace with the following:</p> <p>"Tighten bolts connecting the pole to the frangible base to a snug tight condition. Snug tight is the tightness attained by a few impacts of an impact wrench, or the full effort of a person using an ordinary spud wrench. The lock washers must be fully compressed."</p>
678*	819.04	<p>Delete the last item in the list on this page reading:</p> <p>"DB Cable, in Conduit, 600 Volt, (number) 1/C# (size) Foot"</p>
680	819.04	<p>Change the first paragraph to read:</p> <p>"Unless otherwise required, the unit prices for the pay items listed in this subsection include the cost of excavation, granular material, backfill, and disposal of waste excavated material. If the contract does not include pay items for restoring the site in kind in accordance with section 816, the Department will consider the cost of restoration included in the pay items listed in this subsection."</p>
680	819.04.A	Add the following paragraph after the first paragraph of the subsection.

Page	Subsection	Errata
		<p>“The unit prices for Conduit, Rem include the cost of removing the type, number, and size of conduit shown on the plans.”</p> <p>Change the third paragraph of the subsection to read: “The unit prices for Conduit, (type), __ inch and Conduit, DB, (number), __ inch include the cost of installing the type, number, and size of conduit shown on the plans, and installing marking tape.”</p>
681	819.04.B	<p>Change the last paragraph of the subsection to read: “The unit price for DB Cable, in Conduit, Rem includes the cost of removing all cables from the existing conduit measured per lineal foot of conduit.”</p>
681	819.04.C	<p>Change the first paragraph of the subsection to read: “The unit prices for Cable, Rem and Cable, (type), Rem include the cost of dead ending, circuit cutting, installing guying, work required to leave circuits operable, and disposing of the removed cables, wire, hardware, and other appurtenances.”</p>
681	819.04.D	<p>Change the first paragraph of the subsection to read: “The unit price for Cable, Pole, (type), Disman includes the cost of dismantling and off-site disposal of the following:”</p>
685	820.01.D	<p>Change the sentence to read: “Excavate, backfill, restore the site in kind in accordance with section 816, and dispose of excess or unsuitable material;”</p>
688	820.03.C	<p>Change the seventh paragraph of this subsection to read: “Tighten top anchor bolt nuts, snug, in accordance with the first four paragraphs of subsection 810.03.N.2, except beeswax will not be required.”</p>
696	820.04	<p>Add the following pay items to the list: “Pedestal, Pushbutton, Alum.....Each Pedestal, Pushbutton, Rem.....Each”</p>
697	820.04.A.2	<p>Change the sentence to read: “If the contract does not include pay items for restoring the site in kind in accordance with section 816, the Department will consider the cost of restoration included in the pay items listed in this subsection.”</p>
698	820.04.B	Delete the second paragraph of this subsection found on this page.
698	820.04.C	Change " Fdns " to read " Fdn " in four instances in this subsection.
701	820.04.J.3	Change the sentence to read: "Installing wires in the saw slots and to the handholes;"
701.	820.04.J	Add the following as a new subsection:

Page	Subsection	Errata
		"7. A 3/4 inch minimum flexible conduit (non-metallic and rated for underground use) from the pavement to the handhole."
706	821.01.B	Change the website address listed after the second paragraph on this page to read: <u>"http://www.ngs.noaa.gov/heightmod/GuidelinesPublications.shtml"</u>
711	822.03.B	Change the second paragraph to read: "If corrugations are required on concrete shoulders and the method of installation is not shown on the plans or directed by the Engineer, construct corrugations by grinding, or cutting."
720	823.04	Change the pay item seventh from the bottom of the list to read: "Water Shutoff, Adj, Temp, Case ___"
730	824.03.Q	Change the third sentence of the fourth paragraph to read: "Ensure placement of monumentation in accordance with section 821."
730	824.03.Q	Change the first sentence of the last paragraph to read: "The Department will not pay for work dependent on lost or destroyed stakes until the Contractor replaces the stakes."
732	824.04	Change the first sentence of the first paragraph following the list of pay items to read: "If the Engineer determines the Contractor will perform staking as extra work, the Department will pay for staking in accordance with section 103."
733	824.04	Change the left column header in Table 824-2 to read: "Percent of Original Contract Amount Earned"
739	902.02	Change the last aggregate testing description to read: "Determining Specific Gravity and Absorption of Fine Aggregates.....MTM 321"
742	902.03.C.1.a	Change the sentence to read: "Coarse aggregate includes all aggregate particles greater than or retained on the 3/4-inch sieve."
742	902.03.C.2.a	Change the sentence to read: "Intermediate aggregate includes all aggregate particles passing the 3/4-inch sieve through those retained on the No. 4 sieve."
742	902.03.C.2.b.iii	Change the sentence to read as follows: "Maximum Loss by Washing per MTM 108 of 3.0 percent".
744	902.07	Delete the fourth paragraph of the subsection and replace it with the following: "The Engineer will only allow the use of granular material produced from crushed portland cement concrete for embankment and as trench

Page	Subsection	Errata
		backfill for non-metallic culvert and sewer pipes without associated underdrains. However, granular material produced from crushed portland cement concrete is not permitted as swamp backfill, nor within the top 3 feet below subgrade regardless of the application.
746*	902.11	<p>Change the Item of Work by Section Number column in Table 902-1 for the 6AA row to read: "406, 601, 602, 706, 708, 806".</p> <p>Change the Item of Work by Section Number column in Table 902-1 for the 6A row to read: "206, 401, 402, 406, 601, 602, 603, 706, 806".</p> <p>Change the Item of Work by Section Number column in Table 902-1 for the 34R row to read: "401, 404, 406".</p>
751*	902.11	Replace Table 902-6 with the Table 902-6 below.
751	Table 902-7	Under the Material column in the fourth row change the "FA2" to read "2FA".
751	Table 902-7	Under the Material column in the fifth row change the "FA3" to read "3FA".
752	Table 902-8	Under the Material column in the fourth row change the "FA2" to read "2FA".
752	Table 902-8	Under the Material column in the fifth row change the "FA3" to read "3FA".
761	Table 904-2	Delete the footnote f and any other reference to footnote f from the table.
767	905.03	Change the first sentence of the first paragraph to read: "Deformed bars, must meet the requirements of ASTM A 706, ASTM A 615, or ASTM A 996 (Type R or Type A only) for Grade 60 steel bars, unless otherwise required".
767*	905.03	Change the first sentence of the second paragraph to read: "Unless otherwise specified, spiral reinforcement must meet the requirements of plain or deformed Grade 40 steel bars of ASTM A 615, ASTM A 996 (Type A), or the requirements of cold-drawn wire of ASTM A 1064".
767	905.03	Change the first sentence of the third paragraph to read: "Bar reinforcement for prestressed concrete beams must meet the requirements of ASTM A 996 (Type R) for Grade 60 steel bars, except the Engineer will allow bar reinforcement that meets the requirements of ASTM A 615 or ASTM A 996 (Type A) for Grade 40 steel bars for stirrups in prestressed concrete beams".
768	905.03.C	Change the first sentence in the subsection to read:

Page	Subsection	Errata
		"Epoxy coated steel reinforcement, if required, must be coated in accordance with ASTM A 775, with the following exceptions and additions."
768	905.03.C.3	Change the first sentence of this subsection to read: "Include written certification that the coated reinforcing bars were cleaned, coated, and tested in accordance with ASTM A 775 with the coating applicator."
768	905.05	Change the first sentence of the first paragraph to read: "Deformed steel bars must meet the requirements of ASTM A 706 or the requirements for Grade 40, Grade 50, or Grade 60 of ASTM A 615 or ASTM A 996 (Type R or Type A only)".
768	905.06	Delete this subsection in its entirety and replace it with the following: "Deformed wire fabric for prestressed concrete and fabric for concrete pavement reinforcement must meet the requirements of ASTM A 1064 and fabricated as required."
772	906.07	Change the first paragraph to read: "High-strength bolt fasteners for structural joints must meet the requirements of ASTM A 325 Type 1 bolts. High-strength nuts for structural joints must meet the requirements of ASTM A 563 Grade DH or AASHTO M 292 Grade 2H. High-strength washers for structural joints must meet the requirements of ASTM F 436 Type 1 for circular, beveled, clipped circular, and clipped beveled washers." Change the second sentence of the second paragraph of this subsection to read: "Galvanized nuts must be tapped oversize in accordance with ASTM A 563 and meet Supplementary Requirements S1, Lubricant and Rotational Capacity Test for Coated Nuts and S2, Lubricant Dye."
777*	907.03.D.2.a	Change the first sentence of the second paragraph to read: "Angle sections must be nominal 2½ inch by 2½ inch by ¼ inch."
777*	907.03.D.2.b	Change the first sentence of the first paragraph to read: "Angle section braces must be nominal 1¾ inch by 1¾ inch by ¼ inch or nominal 2 inch by 2 inch 3/16 inch."
782	908.04	Change the first sentence of the first paragraph of this subsection to read: "Steel castings for steel construction must meet the requirements of ASTM A 148 for Grade 60/90 carbon steel castings, as shown on the plans, unless the Engineer approves an alternate in writing."
783*	908.09.A	Change the title of this subsection and the first sentence to read "A. Base Plates, Angle, and Non-Tubular Post Elements. Galvanized base plates, angle, rail splice elements, and non-tubular

Page	Subsection	Errata
		post elements must meet the requirements of ASTM A 36 and ASTM A 123".
783*	908.09.B	Change the title of this subsection and the first sentence to read "B. Rail Elements and Tubular Post Elements. Rail elements and tubular post elements must meet the requirements of ASTM A 500, for Grade B and subsection 908.09.B and be galvanized in accordance with ASTM A 123".
784*	908.09.C	Change this subsection to read: "C. Hardware. Railing anchor studs must meet the requirements of ASTM A 449. Heavy hex nuts must meet the requirements of ASTM A 563. Bolts, used as rail fasteners, must meet the requirements of ASTM A 325, Type 1. Where called for, round head bolts must meet the requirements of ASTM A 449. The material for the railing hand hole screws must meet the requirements of ASTM A 276, Type 304. All nuts must meet the requirements of ASTM A 563 Grade DH or AASHTO M 292 Grade 2H. All flat washers must meet the requirements of ASTM F 436. Lock washers must be steel, regular, helical spring washers meeting the requirements of ANSI B18.21.1 - 1972. Bolts, nuts, washers and other hardware must be hot-dip galvanized in accordance with AASHTO M 232. Galvanized nuts must be tapped oversize in accordance with ASTM A 563, and meet Supplementary Requirements S1, Lubricant and Rotational Capacity Test for Coated Nuts, and S2, Lubricant Dye."
785	908.11.B	Change the second paragraph to read: "Bolts, nuts, and round washers for guardrail, other than at bridge barrier railings, must meet the requirements of ASTM A 307, ASTM A 563 (Grade A with Supplementary Requirements S1 of ASTM A 563), and ASTM F 436, respectively." Change the third paragraph to read: "Washers, other than round washers, for guardrail must meet the requirements for circular washers in ASTM F 436 except that the dimensions must be as shown on the plans." Change the fifth paragraph to read: "Bolts, nuts, and washers for connections at bridge barrier railings must conform to ASTM A 325 Type 1 galvanized high-strength structural bolts with suitable nuts and hardened washers."
787	908.14.B	Add the following sentence to the end of the third paragraph of this subsection: "Exposed threaded ends of anchor bolts must be galvanized a minimum of 20 inches." Change the sixth paragraph in this subsection to read: "Provide washers meeting the requirements of ASTM F 436 for circular washers."

Page	Subsection	Errata
787	908.14.B	Change the second sentence of the fourth paragraph to read "After coating, the maximum limit of pitch and major diameter for bolts with a diameter no greater than 1 inch may exceed the Class 2A limit by no greater than 0.021 inch, and by no greater than 0.031 inch for bolts greater than 1 inch in diameter".
787*	908.14.C	Change the first paragraph to read "Provide either four or six high strength anchor bolts per the contract plans, meeting the mechanical requirements of ASTM F 1554, for Grade 105, with each standard. Anchor bolts for traffic signal strain poles must meet the requirements of subsection 908.14.B with the following exceptions and additions:"
789	909.03	Change the second sentence of the second paragraph to read: "As an alternative to the AASHTO M 36 requirements for metal pipe, the Contractor may use gasket material meeting the low temperature flexibility and elevated temperature flow test requirements of ASTM C 990, excluding the requirements for softening point, flashpoint and fire point."
793	909.06	Change the first sentence of the second paragraph of this subsection to read: "Provide Corrugated Polyvinyl Chloride Pipe (CPV) and required fittings meeting the requirements of AASHTO M 304."
793*	909.05.D	Change the second sentence of the paragraph to read "Provide a continuous welded joint to create a watertight casing that is capable of withstanding handling and installation stresses. Perform field welding by the SMAW process using E7018 electrodes."
794*	909.08.A	Change the first sentence to read: "Provide bridge deck downspouts of PE pipe meeting the requirements of ASTM F 714, PE 4710, DR 26."
804	Table 909-9	In the note area at the bottom of the table change the designation of the second note from "c." to "b."
811	910.04	Add the following sentence to the end of this subsection: "Fabricate silt fence according to subsection 916.02."
814	Table 911-1	In the 4 th row of the 5 rows in the table change the Property listed as "Total Organic Content (TOC)" to read "Total Organic Carbon (TOC)".
829*	912.08.K	Replace Table 912-10 with the Table 912-10 below.
833*	913.03.B	Change the first sentence of the first paragraph to read: "Clay brick, to construct manholes, catch basins, and similar structures, must meet the requirements of ASTM C 32, for Grade MS."
837*	914.04	Add the following as subsection 914.04.C:

Page	Subsection	Errata
		“C. Lubricant-Adhesive for Neoprene Joint Seals. The lubricant-adhesive must be a single-component moisture-curing polyurethane and aromatic hydrocarbon solvent mixture meeting ASTM D 2835, Type I. Ship in containers plainly marked with the lot or batch number of the material and date of manufacture. Store at temperatures between 58 and 80°F. Do not exceed 12 months shelf-life prior to use.”
840	914.08	Change the first sentence of the second paragraph to read: “Straight tie bars for end-of-pour joints must consist of bars of the diameter and length shown on the plans meeting the requirements of ASTM A 615, ASTM A 706, or ASTM A 996 (Type R or Type A only)”.
840*	914.09.A	Change the first sentence of the first paragraph to read: “Straight tie bars for longitudinal pavement joints must consist of bars of the diameter and length shown on the plans meeting the requirements of ASTM A 615, ASTM A 706, or ASTM A 996 (Type R or Type A only)”.
840	914.09.B	Change the first sentence of the first paragraph to read: “Bent tie bars for bulkhead joints must consist of bars of the diameter and length shown on the plans.”
841	914.12	In the first sentence of this subsection change "AASHTO Division II" to read "AASHTO LRFD Bridge Construction Specifications".
841*	914.13	In the first sentence of this subsection change "ASTM D 1248, for Type III, Class B" to read "ASTM D 4976, Group 2, Class 4, Grade 4".
844	916.01.A	Change the first sentence to read: "Cobblestone must consist of rounded or semi-rounded rock fragments with an average dimension from 3 inches to 10 inches."
845	916.01.D.1	Change the second sentence to read: "Checkdams for ditch grades 2 percent or greater must be constructed using cobblestone or broken concrete ranging from 3 inches to 10 inches in size."
851*	917.10.B.1	Delete the paragraph and replace it with the following: “1. Class A. Provide and apply Class A chemical nutrient fertilizer either according to MSU Soil Testing Lab Recommendations for Phosphorus Applications to Turfgrass, except the maximum single application rate of nutrient will be 48 pounds per acre, when soil tests are required or as indicated in subsections 917.10.B.1.a and 917.10.B.1.b.”
851	917.10.B.1	Add the MSU Soil Testing Lab Recommendations for Phosphorus Applications to Turfgrass, found below, after the first paragraph of this subsection.
853	917.15.B.1	Change the second sentence of the subsection to read:

Page	Subsection	Errata
		“The net must meet the requirements of subsection 917.15.D and be capable of reinforcing the blanket to prevent damage during shipping, handling, and installation.”
857	918.01	Add the following two paragraphs following the first paragraph of this subsection: “Wall thickness and outside diameter dimensions must conform to ASTM D 1785 for smooth-wall schedule 40 and 80 PVC conduit material. The Department will allow no more than 3 percent deviation from the minimum wall thickness specified. Wall thickness range must be within 12 percent in accordance with ASTM D 3035 for smooth-wall coilable schedule 40 and 80 PE conduit.”
858	918.01.E	Delete the first three sentences of the second paragraph shown on page 858.
863	918.06.F.1	Delete the third paragraph in this subsection in its entirety and replace it with the following: "Provide smooth or deformed welded wire fabric in accordance with ASTM A 1064."
864	918.07.C	Change the first sentence of the first paragraph to read: “Provide anchor bolts, nuts, and washers meeting the requirements of subsection 908.14.A and subsection 908.14.B.”
864	918.07.C	Delete the second sentence of the second paragraph.
864	918.07.C	Change the third sentence to read: “Provide anchor bolts threaded 4 inches beyond the anchor bolt projection shown on the plans.”
867	918.08.C	Change the last sentence of the first paragraph on this page to read: “Galvanize bolts, nuts, washers, and lock washers as specified in subsection 908.14.B.”
867	918.08.C	Change the last sentence of the subsection to read: “Provide each frangible base with manufacturer access covers as shown on the plans.”
867*	918.08.D	Delete this subsection in its entirety and replace with the following: "Provide galvanized anchor bolts, studs, nuts, couplings, and washers in accordance with subsection 908.14."
879	918.10.J	Change the third sentence of the second paragraph of this subsection to read: "Provide anchor bolts and associated nuts, washers, and hardware meeting the requirements of subsection 908.14."
887	919.06	Change the second paragraph to read:

Page	Subsection	Errata
		“Shims must be fabricated from brass shim stock or brass strip meeting the requirements of ASTM B 36, for copper alloy UNS No. C26000, half-hard rolled temper, or fabricated from galvanized sheeting meeting the requirements of ASTM A 653, for Coating Designation G 90.”
887	919.07.C	Change the sentence to read: “Galvanized high-strength steel bolts, nuts, and washers for connecting arm connection flanges must meet the requirements of subsection 906.07.”
903	921.03.D	Delete the last three sentences of the first paragraph of this subsection.
914	921.05.D	Change the first sentence of this subsection to read: "Provide anchor bolts meeting the requirements of subsection 908.14.C, including elongation and reduction of area requirements."
916	921.07	Change the first sentence of the first paragraph to read: "Provide LED case signs internally illuminated by LEDs and changeable message case signs internally illuminated with LED light sources."
936	922.04.B	In the first sentence of the first paragraph change the "R-52" to "R-126".
936	922.04.B	Add the following to the end of the first paragraph: “Hardware used to connect the end section to the barrier must meet the requirements of NCHRP 350 or MASH (Test Level 3 or higher).”
936	922.04.B	In the first sentence of the second paragraph delete "R-52".
936	922.04.B	Change the fourth paragraph of this subsection to read as follows: For all endings requiring impact attenuators provide a NCHRP-350 Test Level 3 or MASH Test Level 3 approved impact attenuation system, unless otherwise approved by the Engineer.
953*	Pay Item Index	Delete the following pay item reading: “DB Cable, in Conduit, 600 Volt, (number) 1/C# (size)678 819”
957	Pay Item Index	Delete the following pay item from the list: Guardrail Buffered End560 807
960	Pay Item Index	Change the following pay item to read: “Mobilization, Max (dollar)107 150”
961	Pay item Index	Delete the following pay items from the list: Pavt Mrkg, (material), 4 inch, SRSM, (color).....598.....811 Pavt Mrkg, (material), 4 inch, SRSM, 2 nd Application, (color).....598.....811
961	Pay Item Index	Change the following pay items in the list to read: Pavt Mrkg, Ovly Cold Plastic, 12 inch, Cross Hatching, (color) Pavt Mrkg, Polyurea, __ inch, Cross Hatching, (color)

Page	Subsection	Errata
		Add the following pay items to the list: "Pavt Mrkg, Polyurea, (legend).....598.....811 Pavt Mrkg, Polyurea, (symbol).....598.....811 Pedestal, Pushbutton, Alum.....696.....820 Pedestal, Pushbutton, Rem.....696.....820"
962	Pay Item Index	Change the following pay items in the list to read: "Pile Driving Equipment, Furn (Structure No.) Pile, Galv (Structure No.)"
963	Pay Item Index	Change the following pay item to read: "Rem Curing Compound, for Longit Mrkg, __ inch598 811"
964	Pay Item Index	Change the following pay item to read: "Sewer, CI __, __ inch, Jacked in Place200 402" "Sign Cover, Type I.....622 812"
965*	Pay Item Index	Change the following pay item in the list to read: "Steel Casing Pipe, __ inch, Tr Det __ Site Preparation, Max (dollar)646 815"
966	Pay Item Index	Delete the following pay item form the list; Temp Casing.....533.....718
967*	Pay Item Index	Delete the following pay item from the list; Truss Fdn Anchor Bolts, Replace.....584.....810
967	Pay Item Index	Change the following pay item in the list to read: "Traf Regulator Control"
968*	Pay item Index	Change the following pay item in the list to read: "Water Shutoff, Adj, Temp, Case __ Watering and Cultivating, First Season, Min (dollar).....646 815 Watering and Cultivating, Second Season, Min (dollar)646 815"
969	Pay item Index	Change the following pay item in the list to read: "Witness, Log, Layout, \$1000.00"
993	General Index	Change "Shop Plans (see Plans and Working Drawings)" to read "Shop Drawings (see Plans and Working Drawings)".

**Table 701-1
Concrete Structure Mixtures**

		Cement Content per cyd (b,c)		Slump (inches)			Minimum Strength of Concrete (f)					
Concrete Grade (e,h)	Section Number Reference (i)			Type A, D or no Admixture	Type MR, F, or G Admixtures (g)		Flexural (psi)			Compressive (psi)		
		lb	sack		Before Admixture	After Admixture (Type MR)	After Admixture (Type F or G)	7 Day	14 Day	28 Day (Class Design Strength)	7 Day	14 Day
D (a)	706, 711, 712	658 (d)	7.0	0 - 3	0 - 6	0 - 7	625	700	725	3,200	4,000	4,500
S1	705	611	6.5	3 - 5	3 - 6	3 - 7	600	650	700	3,000	3,500	4,000
T	705, 706	611	6.5	3 - 7	3 - 7	3 - 8	550	600	650	2,600	3,000	3,500
S2 (a)	401, 705, 706, 712, 713, 801, 802, 803, 810	564	6.0	0 - 3	0 - 6	0 - 7	550	600	650	2,600	3,000	3,500
S3	402, 403, 803, 804, 806	517	5.5	0 - 3	0 - 6	0 - 7	500	550	600	2,200	2,600	3,000
		489 (d)	5.2									

a. Unless otherwise required, use Coarse Aggregate 6AA or 17A for exposed structural concrete in bridges, retaining walls, and pump stations.

b. Do not place concrete mixtures containing supplemental cementitious materials unless the local average minimum temperature for the next 10 consecutive days is forecast to be above 40 °F. Adjustments to the time required for opening to construction or vehicular traffic may be necessary. Cold weather protection may be required, as described in the quality control plan. The restriction does not apply to Grade S1 concrete in foundation piling below ground level or Grade T concrete in tremie construction.

c. Type III cement is not permitted.

d. Use admixture quantities specified by the Qualified Products Lists to reduce mixing water. Admixture use is required for Grade D, Grade S2, and Grade S3, concrete with a reduced cement content. Use a water-reducing retarding admixture at the required dosage for Grade D concrete to provide the setting retardation required. When the maximum air temperature is not forecast to exceed 60 °F for the day, the Contractor may use a water-reducing admixture or a water-reducing retarding admixture. Ensure Grade D concrete in concrete diaphragms contains a water-reducing admixture, or a water-reducing retarding admixture. For night casting, the Contractor may use a water-reducing admixture in lieu of water-reducing retarding admixture, provided that the concrete can be placed and finished prior to initial set.

e. The mix design basis for bulk volume (dry, loose) of coarse aggregate per unit volume of concrete is 68% for Grade S1, and 70% for Grade D, Grade S2, Grade T, and Grade S3.

f. The Contractor may use flexural strength to determine form removal. Use compressive strength for acceptance in other situations.

g. MR = Mid-range.

h. The Engineer will allow the use of an optimized aggregate gradation as specified in section 604.

i. Section Number Reference:

401	Culverts	711	Bridge Railings	803	Concrete Sidewalk, Sidewalk Ramps, and Steps
402	Storm Sewers	712	Bridge Rehabilitation-Concrete	804	Concrete Barriers and Glare Screens
403	Drainage Structures	713	Bridge Rehabilitation-Steel	806	Bicycle Paths
705	Foundation Piling	801	Concrete Driveways	810	Permanent Traffic Signs and Supports
706	Structural Concrete Construction	802	Concrete Curb, Gutter and Dividers		

An asterisk (*) indicates an entry which has been revised from an earlier version of this Supplemental Specification.

**Table 902-6
Superpave Final Aggregate Blend Physical Requirements**

Est. Traffic (million ESAL)	Mix Type	Percent Crushed Minimum Criteria		Fine Aggregate Angularity Minimum Criteria		% Sand Equivalent Minimum Criteria		Los Angeles Abrasion % Loss Maximum Criteria		% Soft Particles Maximum Criteria (b)		% Flat and Elongated Particles Maximum Criteria (c)	
		Top & Leveling Courses	Base Course	Top & Leveling Courses	Base Course	Top & Leveling Courses	Base Course	Top & Leveling Courses	Base Course	Top & Leveling Courses	Base Course	Top & Leveling Courses	Base Course
< 0.3	LVSP	55/—	—	—	—	40	40	45	45	10	10	—	—
< 0.3	E03	55/—	—	—	—	40	40	45	45	10	10	—	—
≥0.3 - <1.0	E1	65/—	—	40	—	40	40	40	45	10	10	—	—
≥1.0 - < 3	E3	75/—	50/—	40(a)	40(a)	40	40	35	40	5	5	10	10
≥3 - <10	E10	85/80	60/—	45	40	45	45	35	40	5	5	10	10
≥10 - <30	E30	95/90	80/75	45	40	45	45	35	35	3	4.5	10	10
≥30 - <100	E50	100/10 0	95/90	45	45	50	50	35	35	3	4.5	10	10

(a) For an E3 mixture type that enters the restricted zone as defined in Table 902-5, the minimum is 43. If these criteria are satisfied, acceptance criteria and associated incentive/disincentive or pay adjustment tied to this gradation restricted zone requirement included in contract, do not apply. Otherwise, final gradation blend must be outside of the restricted zone.

(b) Soft particles maximum is the sum of the shale, siltstone, ochre, coal, clay-ironstone and particles that are structurally weak or are non-durable in service.

(c) Maximum by weight with a 1 to 5 aspect ratio.

Note: "85/80" denotes that 85 percent of the coarse aggregate has one fractured face and 80 percent has at least two fractured faces.

Table 912-10				
Minimum Retention Requirements				
Preservative	Minimum Retention, (pcf)			AWPA Standard
	Guardrail Posts	Sign Posts	Blocks	
Pentachlorophenol	0.60	0.50	0.40	A6
CCA, ACZA	0.60	0.50	0.40	A11
ACQ (a)	0.60	Not Allowed	0.40	A11
CA-B (a)	0.31	Not Allowed	0.21	A11
CA-A (a)	0.31	Not Allowed	0.15	A11
Other Waterborne preservatives	AWPA Commodity Specification A, Table 3.0, Use Category 4B	Not Allowed	AWPA Commodity Specification A, Table 3.0, Use Category 4A	A11
a. Non-Metallic washers or spacers are required for timber and lumber treated with ACQ or CA placed in direct contact with aluminum. Do not use with sign posts.				

MSU Soil Testing Lab Recommendations for Phosphorus Applications to Turfgrass
3/8/2012

		Sand based rootzone establishment	Golf greens and tees est. or mature; Kentucky bluegrass or perennial ryegrass athletic fields est. or mature; sand based rootzone mature	Lawns, golf course fairways; establishment or mature	Establishment without soil test
Bray P1, Mehlich 3 Soil Test Value (ppm): pH<7.4	Olsen Soil Test Value (ppm) pH>7.4	Recommendation (lbs. P ₂ O ₅ /1000 ft. ²)	Recommendation (lbs. P ₂ O ₅ /1000 ft. ²)	Recommendation (lbs. P ₂ O ₅ /1000 ft. ²)	Recommendation (lbs. P ₂ O ₅ /1000 ft. ²)
0	0	4.4	3.4	2.5	2.5 lbs. year (Maximum single application of 1.5 lbs.)
2	1.3	4.1	3.1	2.2	
4	2.7	3.9	2.7	1.9	
6	4	3.6	2.4	1.6	
8	5.3	3.4	2.0	1.3	
10	6.7	3.1	1.7	1.0	
12	8	2.8	1.4	0.7	
14	9.3	2.6	1.0	0.4	
16	10.7	2.3	0.7	0.1	
18	12	2.1	0.3	0.0	
20	13.3	1.8	0.0		
22	14.7	1.5			
24	16	1.3			
26	17.3	1.0			
28	18.7	0.8			
30	20	0.5			
32	21.3	0.2			
34	22.7	0.0			

Web resources: www.turf.msu.edu or www.bephosphorusmart.msu.edu

**GEOTECHNICAL INVESTIGATION
MISCELLANEOUS GEOTECHNICAL SERVICES –
NORTH AREA BORINGS
ANN ARBOR, MICHIGAN
CTI PROJECT NO. 3122040060-1**

NOVEMBER 13, 2012

Prepared for:

**City of Ann Arbor
Public Services Area - Project Management
301 E. Huron Street
P.O. Box 8647
Ann Arbor, Michigan 48104-8647**

Prepared by:

**CTI and Associates, Inc.
51331 W. Pontiac Trail
Wixom, Michigan 48393
248-486-5100**



November 13, 2012

Mr. Nicholas Hutchinson, P.E., Project Engineer
City of Ann Arbor
Public Services Area - Project Management
301 E. Huron Street
P.O. Box 8647
Ann Arbor, Michigan 48104-8647

**RE: Geotechnical Investigation
Miscellaneous Geotechnical Services –
North Area Borings
Ann Arbor, Michigan
CTI Project No. 3122040060-1**

Dear Mr. Hill:

As requested, CTI and Associates, Inc. (CTI) has completed a geotechnical investigation as part of the Miscellaneous Geotechnical Services contract for the “North Area” soil borings. This phase of work included performing a total of 114 soil borings on seventeen different streets within Ann Arbor city limits. The majority of the soil borings were performed for the design phase of the City of Ann Arbor’s Street Resurfacing program. The remaining borings were performed to support utility design projects.

The enclosed report presents the results of our findings and an engineering interpretation of these with respect to the soil related phases of the project including pavement and construction recommendations. Based on the soils encountered, we anticipate subgrade improvement will be necessary on Depot Street and several isolated areas on the remaining streets. The specific areas requiring subgrade improvement should be anticipated during the design phase, based on the information contained in this report, and further defined during the construction phase.

The pavement cores and soil samples will be retained in our laboratory for a period of thirty (30) days, unless instructed otherwise, and may be examined upon request.

We appreciate the opportunity to be of service to you on this project. If you have any questions regarding this report or if we can be of further assistance, such as providing field monitoring and quality control inspection services during construction, please contact our office.

Sincerely,

CTI and Associates, Inc.

Theresa M. Marsik, P.E., LEED AP
Senior Project Engineer

Kevin Foye, Ph.D., P.E.
Project Engineer

TABLE OF CONTENTS

1.0	INTRODUCTION	1
1.1.	General.....	1
1.2.	Purpose and Scope	1
2.0	SITE CONDITIONS AND PROJECT DESCRIPTION	3
2.1.	Project Description.....	3
2.2.	Site Conditions	4
3.0	INVESTIGATION PROCEDURES	5
3.1.	Field Investigation.....	5
3.2.	Laboratory Testing.....	6
4.0	GENERAL SUBSURFACE CONDITIONS	8
4.1.	Pavement and Soil Conditions	8
4.1.1.	W. Ann Street	8
4.1.2.	Barton Drive	8
4.1.3.	Depot Street.....	9
4.1.4.	S. Division Street	9
4.1.5.	Geddes Avenue	9
4.1.6.	Green Road	10
4.1.7.	Hiscock Street.....	10
4.1.8.	Miller Avenue	11
4.1.9.	Moore Street	11
4.1.10.	Newport Road	12
4.1.11.	Penberton Court/Penberton Drive	12
4.1.12.	Rock Creek Drive/Court	13
4.1.13.	S. State Street.....	13
4.1.14.	N. Thayer Street.....	14
4.1.15.	Yellowstone Drive	14
4.2.	Groundwater Conditions	16
5.0	ANALYSIS AND DESIGN RECOMMENDATIONS	17
5.1.	Site Preparation and Engineered Fill Placement.....	17
5.2.	Pavement Design Considerations.....	20
6.0	GENERAL CONSTRUCTION PROCEDURES / RECOMMENDATIONS	23
6.1.	General.....	23
6.2.	Groundwater Control	23

APPENDIX

Boring Logs, Summary of Laboratory Test Results, General Notes for Soil Classification



**GEOTECHNICAL INVESTIGATION
MISCELLANEOUS GEOTECHNICAL SERVICES –
NORTH AREA BORINGS
ANN ARBOR, MICHIGAN
CTI PROJECT NO. 3122040060-1**

NOVEMBER 13, 2012

1.0 INTRODUCTION

1.1. General

This report presents the results of the geotechnical investigation performed by CTI and Associates, Inc. (CTI) for the “North Area” soil borings as part of the Miscellaneous Geotechnical Services contract. The majority of the soil borings were performed for the design phase of the City of Ann Arbor’s Street Resurfacing program. The remaining borings were performed to support utility design projects.

Recommendations for the construction observation and preparation of the encountered subgrade soils to make them suitable for pavement construction are included in the report sections that follow. Of particular concern is the poor-draining nature of the encountered soils and fill materials in the subgrade. These materials may not be suitable for direct pavement support and will require further evaluation and improvement as detailed below.

Our evaluation was performed in general accordance with the scope of services outlined in the CTI Proposal No. 112PR02040-100 dated July 12, 2012 and the Professional Services Agreement between the City of Ann Arbor and CTI dated August 1, 2012. Purchase Order No. 2013-00000194 was issued by City of Ann Arbor on September 17, 2012.

1.2. Purpose and Scope

The purpose of this study was to determine the general subsurface conditions at the site by performing pavement cores and drilling test borings, and to evaluate these conditions with respect to pavement support requirements for the proposed project. Specifically, the report presents our evaluations and recommendations regarding the following items:

- A. General subsurface (soil and groundwater) conditions at the site.
- B. Design recommendations: These include recommendations for support of pavement, including pavement design parameters as they relate to the encountered soils.
- C. Construction recommendations: These include site preparation and earthwork operations, groundwater conditions and controls, potential construction problems and recommendations dealing with quality control during construction.

The evaluations and recommendations discussed in this report are based on the soil conditions encountered in the test borings performed at the specific locations on the date indicated on the boring logs. The soil conditions may vary at locations other than those encountered at the soil boring locations. These variations may not become evident until the time of construction.

If variations in the reported soil conditions are encountered, CTI should be contacted immediately. In such a case, it may be necessary for CTI to reevaluate the recommendations of this report. Such a reevaluation may be possible from on-site observations or may require additional investigations. If any such variations are revealed, they may result in increased construction costs. A contingency should be provided in the project budget to accommodate such variations.

CTI's authorized scope of services included a geotechnical study of the subject site and did not include an environmental assessment for determining the presence or absence of hazardous or toxic materials in the soil or groundwater at, below or around the site. The presence or absence of contaminated material is not implied, inferred or suggested by this report or the results of this study. Any statement contained within this report or presented on the soil boring logs regarding odors, colors or unusual items are strictly for informational purposes only. If any recognized environmental concerns are identified for this site, the evaluations and/or recommendations presented in this report may require amendment.

2.0 SITE CONDITIONS AND PROJECT DESCRIPTION

2.1. Project Description

CTI was awarded the “North Area” borings on September 14, 2012. Additional borings were added to the scope and boring depths were modified through October 1, 2012. This phase of work included performing a total of 114 soil borings on seventeen different streets within Ann Arbor city limits. The proposed boring locations were marked in the field by the City of Ann Arbor personnel prior to our field activities. CTI was notified on September 25, 2012 that all of the boring locations were marked. Once we were notified that the boring locations had been marked, CTI requested the Miss Dig service to locate the existing underground utility locations at each boring location. Several borings were off-set from the marked location due to conflicts with underground utilities, overhead obstructions (trees and overhead electric lines) and/or to maintain traffic flow. Table 1 presents the specific breakdown of the number of borings per street, the boring depths, and the limits of exploration.

Table 1. Summary of Geotechnical Investigation Scope

Street Name	Limits	Number of Borings	Boring Depth (ft)
W. Ann Street	First Avenue to N. Main Street	2	5
Barton Drive	Pontiac Trail to Plymouth Road	8	5
Depot Street	N. Main Street to Carey Street	4	5
S. Division Street	Huron Street to Packard Street	9	5
Geddes Avenue	Observatory Street to Highland Drive	10	5
Green Road	Nixon Road to Burbank Road	18	5
Hiscock Street	Brooks Street to Spring Street	6	5
Miller Avenue	City Limits to Maple Road	9	5
Moore Street	Pontiac Trail to Broadway	2	5
Newport Road	City Limits to Warrington	9	5
Penberton Court	3925 to 3935 Penberton Court	1	5
Penberton Drive	Fox Hunt to Waldenwood	7	5
Pontiac Trail	City Limits to Skydale Drive	7	25
Rock Creek Drive/Ct.	Northern End to Huntington Drive	6	7.5
S. State Street	Washington Street to S. University Avenue	6	5
N. Thayer Street	Huron Street to Kingsley Street	5	5
Yellowstone Drive	Bluett to Bluett	5	5

The recommendations presented in this report are based on the provided and/or assumed project information and the results of our geotechnical exploration. If any of the above noted project information is considered incorrect or is changed, CTI should be informed in writing so that a review can be performed and any necessary revisions to our recommendations can be made.

2.2. Site Conditions

At the time of our field investigation, the existing roadway surfaces consisted of asphalt pavement. No information was provided regarding the age of the existing asphalt pavement.

3.0 INVESTIGATION PROCEDURES

3.1. Field Investigation

Our field investigation consisted of drilling 114 soil borings on seventeen different streets within Ann Arbor city limits. The approximate as-drilled locations of the borings are listed on the boring logs, included with this report. As requested, the majority of the borings were extended to a depth of approximately 5 feet below the top of pavement. Those borings performed on Rock Creek Drive/Court were extended to a depth of 7½ feet, and those borings performed on Pontiac Trail were extended to a depth of 25 feet below the existing grade.

Several boring locations on Pontiac Trail were in conflict with overhead and underground utilities. Miss Dig was contacted and all utilities were supposed to have been marked by September 28, 2012. During the drilling operations on October 12, 2012, a utility marking company arrived at the site to mark fiber optic lines which had not previously been marked, and they informed CTI and Stearns Drilling personnel that a high voltage underground electric line was present at the site which had also not been marked. CTI made several telephone calls to the various utilities – both through the Miss Dig system and directly – but the marking was not completed. Therefore, drilling activities have not been completed for Pontiac Trail. The information from the seven borings for Pontiac Trail will be transmitted separately once drilling on Pontiac Trail has been completed.

The borings were located in the field by City of Ann Arbor personnel prior to the drilling activities. The drilling operations were performed by Stearns Drilling, under direction of CTI personnel between October 3 and October 12, 2012. Prior to drilling the soil borings, the pavement structure was explored with a core drill equipped with a four-inch nominal diameter core barrel. After extraction of the cores at each location, the core samples were measured and labeled. The soil borings were drilled with a CME-1050 rotary drill rig using continuous flight hollow stem augers. Soil samples were obtained at select intervals by the Standard Penetration Test Method (ASTM D-1586), whereby a 2-inch outside diameter split-barrel sampler is driven into the soil with a 140-pound weight falling freely through a distance of 30 inches. The sampler is generally driven three successive 6-inch increments, with the number

of blows for each increment being recorded. The number of blows required to advance the sampler from 6 to 18 inches is termed the Standard Penetration Resistance, N. An additional grab sample was obtained of the aggregate base material directly below the pavement for visual classification purposes.

The soil samples obtained with the split-barrel sampler were sealed in glass jar containers and transported to our laboratory along with the pavement core samples for further classification and testing. After completion of the drilling operations, the boreholes were backfilled with excavated soil (i.e., auger cuttings) and patched with a cold bituminous patching mix.

Soil and groundwater conditions observed in the test borings have been evaluated and are presented on the boring logs included in the Appendix. To aid in understanding the data presented on the boring logs, "General Notes for Soil Classification," describing nomenclature used in soil descriptions, are also included in the Appendix. It should be noted that the soil descriptions reported on the test boring logs are based upon field logs prepared by experienced drillers with modifications made based on the results of laboratory testing and engineering review.

3.2. Laboratory Testing

The laboratory testing program was directed towards determining the general soil classification and physical properties of the soil pertinent for pavement design and site preparation. All laboratory testing was performed in general accordance with applicable ASTM test method standards. The laboratory testing consisted of visual soil classification of every sample, and natural moisture content and loss-on-ignition (organic) testing of selected samples. The unconfined compressive strength of selected cohesive samples was also estimated based on the resistance to a calibrated spring-loaded hand penetrometer. In addition, corrosivity testing, including pH determination, Laboratory Resistivity testing and Oxidation-Reduction Potential testing, was performed on samples from Yellowstone Drive.

The soil samples were visually classified in general accordance with the Unified Soil Classification System (USCS). The estimated USCS group symbol is shown in parentheses following the written description of the various strata on the boring logs. The results of all

laboratory tests are indicated on the boring logs at the depths the samples were obtained and/or on the "Summary of Laboratory Test Results" included in the Appendix, with the exception of the corrosivity testing which is presented in Table 2 of this report.

4.0 GENERAL SUBSURFACE CONDITIONS

The following paragraphs present generalized pavement, soil and groundwater conditions encountered at the test boring locations. For a more detailed description of the subsurface conditions encountered at the site, please refer to the individual soil boring logs.

4.1. Pavement and Soil Conditions

4.1.1. W. Ann Street

Two borings were performed on Ann Street to a depth of 5 feet. Approximately 3 to 4 inches of asphalt pavement was encountered, underlain by 8 to 10 inches of concrete pavement. The concrete pavement was underlain by 0 to 5 inches of sand and gravel aggregate base material. Below the aggregate base material, granular fill material containing trace amounts of organics was encountered to depths of 2 to 3 feet below the pavement surface. The native subgrade soils consisted of silty sand with occasional stiff clay layers. The Standard Penetration Test (SPT) resistance (N) values recorded for the native granular soils ranged from 3 to 24 blows per foot, indicating very loose to medium dense relative densities.

4.1.2. Barton Drive

Eight borings were performed on Barton Drive to a depth of 5 feet. A pavement section consisting of approximately 4 to 6 inches of asphalt with 6 to 12 inches of sand and gravel aggregate base material was typically encountered. The aggregate base at the location of Boring B-8 consisted of 10 inches of crushed limestone. Granular fill materials were encountered to the explored depth of B-2 and to depths of 2¼ to 4 feet within B-4 and B-6 through B-8. The native subgrade soils predominantly consisted of sand with varying amounts of silt and clay. The N-values within the native granular soils typically ranged from 2 to 11 blows per foot, indicating very loose to medium dense relative densities. The relative density of the sand decreased with depth. At the location of B-1, the native subgrade soils consisted of clay. N-values for the native clay

soils ranged from 7 to 10 blows per foot. The unconfined compressive strength of the tested samples typically ranged from 6,000 pounds per square foot (psf) to 7,000 psf, indicating a very stiff consistency.

4.1.3. Depot Street

Four borings were performed on Depot Street to a depth of 5 feet. A pavement section consisting of approximately 7 to 8 inches of asphalt with 4 to 8 inches of sand and gravel aggregate base material was encountered. The pavement sections were underlain by granular fill to depths of about 3 to 4½ feet. The native subgrade soils typically consisted of loose to medium dense silty sand, with N-values in the range of 9 to 22 blows per foot. The native subgrade soils encountered within B-1 through B-3 contained some organics. Loss-on-Ignition (organic content) of the subgrade soils encountered within B-2 was 8.4 percent.

4.1.4. S. Division Street

Nine borings were performed on S. Division Street to a depth of 5 feet. Approximately 2 to 14 inches of asphalt pavement was encountered, underlain by 0 to 12 inches of concrete pavement. Below the concrete pavement, 4 to 10 inches of crushed limestone aggregate base was typically encountered, with the exceptions of Borings B-1, B-2 and B-8 where 6 inches of sand and gravel aggregate base materials were encountered. Below the aggregate base materials encountered within B-1 and B-4, clay fill containing trace amounts of organics was encountered to depths of about 3½ to 4 feet. The native subgrade soils typically consisted of loose to medium dense sand with varying amounts of silt and isolated layers of stiff clay. The N-values recorded within the native granular soils ranged from 5 to 25 blows per foot, indicating loose to medium dense relative densities.

4.1.5. Geddes Avenue

Ten borings were performed on Geddes Avenue to a depth of 5 feet. Approximately 3 to 12 inches of asphalt pavement was encountered, underlain by 0 to 9 inches of concrete pavement. Below the concrete pavement, 3 to 18 inches of sand and gravel

aggregate base materials were typically encountered. The aggregate base material at B-7 consisted of 30 inches of crushed limestone. No aggregate base course was encountered at the location of Borings B-8 and B-9. The native subgrade soils typically consisted of clay and/or sand with varying amounts of silt. N-values for the native clay soils ranged from 6 to 24 blows per foot. The unconfined compressive strength of the tested samples typically ranged from 2,000 psf to more than 9,000 psf, indicating stiff to hard consistencies. The N-values recorded within the native granular soils ranged from 10 to 13 blows per foot, indicating loose to medium dense relative densities.

4.1.6. Green Road

Eighteen borings were performed on Green Road to a depth of 5 feet. Pavement sections consisting of approximately 4 to 8 inches of asphalt with 7 to 12 inches of crushed limestone aggregate base materials were encountered. The pavement sections were underlain by granular fill to depths of about 2 to 2½ feet. The aggregate base and/or granular fill materials encountered at the location of Boring B-1 through B-5, B-7, B-9 and B-15 were underlain by apparently native granular soils to a depth of 2 to 3 feet. N-values ranged from 8 to 22 blows per foot within the native granular soils, indicating loose to medium dense relative densities. The remaining native subgrade soils encountered below the granular fill and native granular subgrade soils typically consisted of clay. The N-values recorded within the native clay soils ranged from 4 to 20 blows per foot. The unconfined compressive strength of the tested samples typically ranged from 1,500 psf to more than 9,000 psf, indicating medium stiff to hard consistencies.

4.1.7. Hiscock Street

Six borings were performed on Hiscock Street to a depth of 5 feet. Approximately 4 to 7 inches of asphalt pavement was encountered. At the location of Boring B-1, the asphalt was underlain by 4 inches of red brick. Approximately 5 to 14 inches of sand and gravel aggregate base material was encountered within the borings. Clay fill was encountered to a depth of about 4 feet within Boring B-4. The native subgrade soils encountered below the clay fill in B-4 and below the aggregate base course in the

remaining borings consisted of sand with varying amounts of silt and clay. The N-values recorded within the native sand layers typically ranged from 7 to 20 blows per foot, indicating loose to medium dense relative densities.

4.1.8. Miller Avenue

Nine borings were performed on Miller Avenue to a depth of 5 feet. Approximately 3 to 12 inches of asphalt pavement was encountered. At the location of Borings B-1, B-8 and B-9, approximately 6 to 16 inches of sand and gravel aggregate base material was encountered; a defined aggregate base course was not observed within the remaining Miller Avenue borings. Below the aggregate base materials encountered within B-8 and B-9, and below the asphalt pavement encountered at B-2 through B-7, granular fill materials were encountered to depths of about 2½ to 4½ feet. Below the aggregate base course encountered within B-1 and below the granular fill materials encountered within the remaining borings, apparently native clay was encountered to the final explored depth of the borings. N-values for the native clay soils typically ranged from 7 to 15 blows per foot. The unconfined compressive strength of the tested samples typically ranged from 4,500 psf to more than 9,000 psf, indicating very stiff to hard consistencies. Within Boring B-6, the unconfined compressive strength was approximately 1,000 psf, indicating a stiff consistency. Trace amounts of organics (Loss-on-Ignition values ranging from 1.6 to 1.8 percent) were observed within the clay subgrade soils at the location of B-1 and B-6.

4.1.9. Moore Street

Two borings were performed on Moore Street to a depth of 5 feet. Approximately 9 to 10 inches of asphalt pavement was encountered. A defined aggregate base course was not observed within the test borings. Below the asphalt pavement, granular fill materials were encountered to depths of about 2½ to 3 feet. The native subgrade soils encountered below the granular fill materials consisted of loose to medium dense sand, with N-values ranging from 4 to 10 blows per foot.

Auger refusal was encountered within Boring B-2 at a depth of about 3 feet. The boring was offset approximately 4 feet from the original borehole and re-drilled.

4.1.10. Newport Road

Nine borings were performed on Newport Road to a depth of 5 feet. Pavement sections consisting of approximately 4 to 7 inches of asphalt with 5 to 20 inches of crushed limestone aggregate base materials were encountered. The pavement sections encountered at the location of Borings B-2, B-4, B-5 and B-9 were underlain by granular fill to depths of about 1½ to 4 feet. The pavement section at the location of B-1 was underlain by granular fill to the final explored depth of the boring. Below the pavement section at the location of Boring B-3, apparently native medium stiff clay containing trace amounts of organics (Loss-on-Ignition value of 3.6 percent) was encountered to a depth of about 4 feet. The native subgrade soils consisted of sand with varying amounts of silt and clay, with isolated layers of clay. The N-values recorded within the native granular soils ranged from 7 to 26 blows per foot, indicating loose to medium dense relative densities. N-values for the native clay soils ranged from 6 to 17 blows per foot. The unconfined compressive strength of the tested samples ranged from 1,000 psf to 1,500 psf, indicating a medium stiff consistency.

4.1.11. Penberton Court/Penberton Drive

One boring was performed on Penberton Court and seven borings were performed on Penberton Drive to a depth of 5 feet. Pavement sections consisting of approximately 4 to 10 inches of asphalt with 4 to 8 inches of sand and gravel aggregate base materials were typically encountered. No defined aggregate base course was observed within Borings B-2, B-4 and B-7 on Penberton Drive. The sand and gravel aggregate base course was underlain by approximately 5 inches of crushed limestone at the location of Penberton Court Boring B-1. At the location of Penberton Court Boring B-1 and B-3, B-5 and B-6 on Penberton Drive, clay fill materials were encountered to 1½ to 3 feet. The native subgrade soils typically consisted of clayey silt/clay, with the exception of Penberton Drive B-6 and B-7 where sand with varying amounts of silt was encountered. The N-values recorded within the native clay soils ranged from 5 to 21

blows per foot. The unconfined compressive strength of the tested samples ranged from 3,000 psf to more than 9,000 psf, indicating stiff to hard consistencies. Within the granular soils, N-values ranged from 12 to 25 blows per foot, indicating a medium dense relative density.

4.1.12. Rock Creek Drive/Court

Six borings were performed on Rock Creek to a depth of 7½ feet. Pavement sections consisting of approximately 2 to 3 inches of asphalt with 9 to 15 inches of sand and gravel aggregate base materials were encountered. The pavement sections at the locations of Borings B-2 and B-4 through B-6 were underlain by sand and clay fill to depths of about 3 to 4 feet. The native subgrade soils consisted of clay and/or sand with varying amounts of silt and clay. N-values for the native clay soils ranged from 9 to 25 blows per foot. The unconfined compressive strength of the tested samples ranged from 3,500 psf to more than 9,000 psf, indicating stiff to hard consistencies. The N-values recorded within the native granular soils ranged from 6 to 15 blows per foot, indicating loose to medium dense relative densities.

4.1.13. S. State Street

Six borings were performed on S. State Street to a depth of 5 feet. At the location of Borings B-1 and B-4 through B-6, 9 to 18 inches of asphalt pavement was encountered. The aggregate base course within B-1, B-5 and B-6 was comprised of 4 to 6 inches of sand and gravel; 9 inches of crushed limestone was encountered below the asphalt pavement at the location of Boring B-4. At the location of Borings B-2 and B-3, approximately 3 to 6 inches of asphalt pavement was encountered, underlain by 4 inches of red brick. The brick was underlain by 3 to 17 inches of sand and gravel aggregate base material. The aggregate base course encountered within B-2 was underlain by 4 inches of concrete pavement. Sand and clay fill materials were encountered to depths of about 4 to 5 feet within B-1, B-5 and B-6. The native subgrade soils consisted of clay and/or sand with varying amounts of silt. The N-values recorded within the native clay soils ranged from 11 to 14 blows per foot. The unconfined compressive strength of the tested samples ranged from 3,000 psf to 6,500

psf, indicating stiff to very stiff consistencies. Within the granular soils, N-values ranged from 4 to 17 blows per foot, indicating loose to medium dense relative densities.

4.1.14. N. Thayer Street

Five borings were performed on N. Thayer Street to a depth of 5 feet. Approximately 3 to 6 inches of asphalt pavement was encountered. Below the asphalt at the location of B-4, approximately 12 inches of concrete pavement was encountered. The asphalt and concrete pavement at the location of Borings B-1, B-4 and B-5 was underlain by 8 to 12 inches of sand and gravel aggregate base material. At the remaining boring locations, the aggregate base course consisted of 3 to 19 inches of crushed limestone. The aggregate base course encountered within B-3 was underlain by granular fill material to a depth of about 4 feet. The native subgrade soils typically consisted of clay and/or sand with varying amounts of silt and clay. N-values for the native clay soils ranged from 5 to 9 blows per foot. The unconfined compressive strength of the tested samples ranged from 1,500 psf to 2,500 psf, indicating medium stiff to stiff consistencies. The N-values recorded within the native granular soils ranged from 5 to 37 blows per foot, indicating loose to dense relative densities.

4.1.15. Yellowstone Drive

Five borings were performed on Yellowstone Drive to a depth of 5 feet. The purpose of these borings was to gather subgrade information pursuant to developing a solution to the recent outbreak of water main breaks in this area. The proposed boring locations were within the lawn extensions (between the sidewalk and the roadway). However, due to utility conflicts, the borings were offset into the roadway.

Approximately 5 to 9 inches of asphalt pavement was encountered at the boring locations. The aggregate base course within B-1 and B-3 through B-5 consisted of 3 to 9 inches of sand and gravel; 7 inches of crushed limestone was encountered below the asphalt pavement at the location of Boring B-2. Clay fill materials were encountered within Borings B-2 and B-4 to depths of about 2 to 3 feet. The fill encountered within B-4 was underlain by 3 inches of wood (possible root), followed by possible clay fill

containing trace amounts of organics. Below the clay fill encountered within B-2 and below the aggregate base course in the remaining borings, native subgrade soils consisting of clay were encountered to the final explored depth of the borings. The N-values recorded within the native clay ranged from 4 to 9 blows per foot. The unconfined compressive strength of the tested samples ranged from 3,000 psf to more than 9,000 psf, indicating stiff to hard consistencies.

Corrosivity testing consisting of pH determination, resistivity testing and oxidation-reduction potential testing were performed in our laboratory on the samples collected at depths between 3½ to 5 feet. The American Water Works Association (AWWA) developed an American National Standard – ANSI/AWWA C105/A21.5 – that addressed the need for polyethylene encasement for ductile iron pipes. The corrosivity testing was performed in accordance with the Soil Survey Tests and Observations section of that standard, which assigns a number of points based on the results of the corrosivity testing. If a soil meets or exceeds a score of 10 points, the standard states that the soils are corrosive to ductile iron pipe and protection is needed. The results of our laboratory corrosivity tests are presented in Table 2 below, along with the points assigned by the standard based on the test results.

Table 2. Corrosivity Test Results for Yellowstone Drive						
Boring Number	Resistivity (ohm-cm)	pH	Oxidation-Reduction Potential (mV)	Sulfides (Negative, Trace or Positive)	Moisture (Poor, Fair or Good Drainage)	Total Points per ANSI/AWWA C105/A21.5
B-1	6,200	6.4	211	Not Tested	Poor	2
B-2	5,100	6.7	243	Not Tested	Poor	2
B-3	5,400	7.0	196	Not Tested	Poor	2
B-4	3,800	6.5	238	Not Tested	Poor	2
B-5	4,800	7.1	251	Not Tested	Poor	2

As directed, the presence of sulfides in the soil samples was not tested. If the soil tests positive for sulfides, the maximum additional points that would be assigned would be 3.5. Therefore, the maximum total point value based on these test results would be 5.5

if sulfides are present in the soil. While indicative of low to moderate corrosivity, this score would not meet the 10 point threshold requiring protection that is presented in the referenced standard.

The above generalized subsurface descriptions are intended to highlight the major stratification features and material characteristics. The individual boring logs should be reviewed for specific information. The stratification depths shown on the boring logs represent the soil conditions at the actual boring locations only. Variations may occur between and/or beyond the boring locations. The nature and extent of any variations may not become evident until the time of construction. In consideration of the current use and previous development of the sites, including utility installations, it would not be unusual for other deposits of fill to be present at the site which were not discovered by the borings. The composition and/or depth of the fill material at this site is expected to be random and may vary in localized areas from the conditions reported herein. If significant variations in the soil conditions or fill material depths are discovered during construction, it should be immediately brought to the attention of CTI before removal.

4.2. Groundwater Conditions

Groundwater observations were conducted during the drilling operations and shortly after completion of the borings. Groundwater seepage was not observed within the test borings either during or after drilling.

The groundwater levels, including perched groundwater accumulations, should be expected to fluctuate seasonally, based on variations in precipitation, evaporation, surface run-off and other factors not evident at the time of our investigation. Typically, groundwater levels and volumes are expected to be higher in the winter and spring seasons compared to the summer and fall months. The actual groundwater levels at the time of construction may vary from those provided herein.

The above soil and groundwater conditions represent a generalized summary of the subsurface conditions and material characteristics. The individual Test Boring Logs should be reviewed for specific information and details relating to specific areas of the site.

5.0 ANALYSIS AND DESIGN RECOMMENDATIONS

At the time this report was prepared, the overall project was in the planning and design stage. The following recommendations have been developed based on the previously assumed/described project characteristics and subsurface conditions. If there is any significant change in the project characteristics from those presented earlier, a review should be made by CTI to determine if any modifications in the evaluations and recommendations included in this report will be required.

As noted previously, several boring locations on Pontiac Trail were staked in direct conflict with utilities. Due to incomplete utility markings, four of the seven borings on Pontiac Trail have been postponed. The information from the seven borings for Pontiac Trail will be transmitted separately once drilling has been completed.

In general, granular and cohesive fill materials containing trace amounts of organics were encountered to varying depths across portions of every explored street. The presence and thickness of fill materials and/or organic-containing soils may vary across the site. If the owner is willing to assume the risks related to decreased pavement life/serviceability by doing so, some or all of the fill could be left in place for pavement support, following proper subgrade preparation activities described in Section 5.1 of this report.

5.1. Site Preparation and Engineered Fill Placement

At the start of earthwork operations, the existing pavement and any other deleterious materials are to be stripped from the new roadway areas. The thickness of the existing pavement, aggregate base and near surface fill layer (where present) should be expected to vary across the site. The depth of unsuitable soil removal should be determined by a representative of CTI at the time of stripping and rough grading.

On Depot Street, the fill was typically underlain by apparently native soils containing some (greater than 5 percent) organics. The subgrade soils on Depot Street will likely require some measure of improvement to provide adequate, long-term pavement support. Improvement measures such as undercutting the upper unsuitable soils and replacing them with engineered

fill or stabilizing the existing subgrade soils with geotextile reinforcement, without performing significant undercuts, should be considered.

Proper evaluation and conditioning (if necessary) of the subgrade should be performed prior to any engineered fill placement. After stripping and excavating to the proposed subgrade level, and after removing any unsuitable materials and underground objects, the rough graded pavement area should be proofrolled with a loaded tandem-axle dump truck or similar rubber-tired vehicle. The purpose of proofrolling operations is to locate areas of excessively loose, soft or weak subgrade soils which may be present at the time of construction. Soils that are observed to rut or deflect excessively during proofrolling should be stabilized by conventional methods such as disking, drying and re-compacting.

If it is not feasible to dry and re-compact the unsuitable subgrade soils due to unfavorable weather conditions, scheduling, etc., it may be necessary to remove such soils and replace them with engineered fill. The thickness of the undercut will depend on the severity of the unstable soils encountered at specific locations. A layer of crushed aggregate may be necessary to stabilize the subgrade before placement of the selected engineered fill material. The use of a geotextile material (e.g. geogrid or fabric) below the crushed aggregate layer could also be considered to provide additional subgrade stability.

It should be noted that the actual locations and depths of any undercutting and/or stabilization should be established in the field at the time of construction. The extent to which yielding subgrades may be a problem is difficult to predict beforehand since it is dependent upon several factors including seasonal conditions, precipitation, construction practices, etc.

Once the site has been evaluated, proofrolled and/or stabilized, the inspected area should not be allowed to remain exposed to wet conditions more than one day or subjected to construction traffic, otherwise a re-evaluation should be made. The site earthwork operations should be carried out during a period of dry weather, if possible. This should minimize potential subgrade problems, although they may not be eliminated. The severity of subgrade instability will depend to a high degree on the weather conditions prevailing during construction.

After subgrade preparation and observation have been completed, any fill placement required to bring the site to the design subgrade level (i.e. the bottom of the proposed aggregate base course) may begin. Any fill placed below the proposed pavement area should be an approved material that is free of topsoil, organics, frozen soil or any other unsuitable material. If granular soils containing greater than 12 percent fines (i.e., silt or clay) are used as fill, close moisture content control will be required to achieve the recommended degree of compaction. Any fill materials encountered at locations other than the boring locations can be further evaluated during site preparation to determine if some of the soils can be reused as engineered fill.

The engineered fill should be placed in uniform horizontal layers not exceeding 8 to 12 inches in loose thickness for clean granular soils and 4 to 6 inches in loose thickness for clay soils (or clayey granular soils exhibiting cohesive characteristics), depending on the type and size of compaction equipment used. The lift thickness for sands that have an appreciable amount of fines should be decreased accordingly. The engineered fill should be compacted to achieve a density of not less than 95 percent of the maximum dry density as determined by the Modified Proctor Compaction Test (ASTM D1557). Also, the upper 12 inches of the subgrade soils should be compacted, prior to any fill placement, to achieve a density of not less than 95 percent of the maximum dry density as determined by the Modified Proctor test. The as-compacted moisture content of the engineered fill should be within 2 to 3 percent of the optimum moisture content for the soil. The placement and testing of engineered fill should be observed and properly documented in the field by CTI.

We recommend that the contract specifications include provisions for moisture conditioning of any on-site soils that are to be used as engineered fill. Some of the natural soils may require moisture conditioning to allow for proper compaction. The success of aeration and drying of clay soils will be dependent on the time of year, the prevailing weather conditions and the contractor's effort. During cold and/or wet periods of the year, the saturated or disturbed clay soils will be more difficult to dry. In this case, the contractor may have to use drier on-site soils or imported sand.

If site grading or other construction activity is planned during cold weather, it is recommended that proper winter construction practices are followed. All snow and ice should be removed

from cut and fill areas prior to grading. Frozen materials should not be used as engineered fill and no fill or pavement should be placed on soils that are frozen or contain frozen material.

5.2. Pavement Design Considerations

The subgrade soils for support of the pavement sections should be prepared in accordance with the methods presented in Section 5.1 of this report. It appears the existing soils and anticipated newly placed engineered fill will be adequate to support the majority of the pavement sections following site preparation activities. Proper evaluation of the subgrade soils should be performed during construction to verify that suitable soil conditions exist for support of the pavement.

The long-term performance of the pavement will typically be a function of the quality of the subgrade soil at the time of construction along with the quality, thickness and strength of the overall pavement section. The most critical portion of the subgrade is the 3 feet immediately beneath the pavement section, which provides the primary strength needed for pavement section support. Soils in a saturated condition, uncontrolled fill and/or organic materials present within the upper 2 to 3 feet of the pavement subgrade can be detrimental if the design does not account for this substandard soil condition, especially during the spring freeze-thaw cycles.

The pavement system should be properly drained to reduce the potential for weakening the subgrade. Provisions should be made to prevent surface run-off water from accumulating within the aggregate base course of the pavement. The pavement and underlying subgrade should be suitably crowned or sloped to promote effective surface drainage and prevent water ponding.

We anticipate that the pavement surface will drain via storm sewers (where present) and via run-off methods where storm sewers are not available. Where the reconstruction project includes the installation of a storm sewer system, finger drains should be installed at all catch basin locations to provide drainage for surface water that may become trapped in the pavement aggregate base course. At a minimum, a system of finger drains or stub drains should be placed around all catch basins within the pavement areas to minimize the accumulation of water in the frost susceptible subgrade soils. These under drains should be installed below the

aggregate base course layer of the pavement system and be properly protected with free-draining coarse aggregate material and filter fabric.

All pavements require regular maintenance and occasional repairs to keep them in a serviceable condition. Of particular value is timely sealing of joints and cracks, which if left unrepaired, can serve to permit water to enter the pavement section and cause rapid deterioration of the pavement during freeze-thaw cycles. The need for such routine maintenance and repair is not necessarily indicative of premature pavement failure. However, if appropriate maintenance and repairs are not performed on a timely basis, the serviceable life of the pavement can be reduced significantly.

Actual pavement section thickness should be provided by the design civil engineer based on design traffic loads and volume and the owner's design life requirements. All pavement materials and procedures should conform to standard MDOT, City of Ann Arbor or appropriate local municipal agency requirements.

Based on the results of the soil borings performed, Resilient Modulus values (M_r) for the encountered soils have been estimated and are presented in Table 3, along with a summary of the encountered pavement and subgrade conditions.

Table 3. Summary of Encountered Conditions and Estimated Soil Properties

Street	Limits	Pavement Thickness (in)		Aggregate Base Thickness (in)		Subgrade Soil Description	Estimated Resilient Modulus, M_r (psi)
		Asphalt	Concrete	Natural Aggregate	Crushed Limestone		
W. Ann	First Avenue to N. Main	3-4	8-10	0-5	0	Sand Fill	7,500
Barton	Pontiac Trail to Plymouth	4-6	0	6-12	10 (at B-8)	Sand Fill/Sand	7,500
Depot	N. Main to Carey	7-8	0	4-8	0	Sand Fill/ Sand and Clay with organics	3,500
S. Division	E. Huron to Packard	2-14	0-12	6 (B-1, B-2 & B-8)	4-10	Silty Sand/Clay	6,000
Geddes	Observatory to Highland	3-12	0-9	0-18	30 (B-7)	Clay Fill/Clay/ Silty Sand	6,000
Green	Nixon to 3344 Green Rd	4-8	0	0	7-12	Sand Fill/Sand/Clay	6,000
Hiscock	Brooks to Spring	4-7	(4 of brick at B-1)	5-14	0	Clay Fill (B-4)/ Sand/Clayey Sand	5,500
Miller	City Limits to Maple	3-12	0	0-16	0	Sand Fill/Clay	6,000
Moore	Pontiac Trail to Broadway	9-10	0	0	0	Sand Fill/Sand	6,500
Newport	City Limits to Warrington	4-7	0	0	5-20	Sand Fill/Sand/Clay	4,000
Penberton Ct	Addresses 3925 to 3935	5	0	5	5	Clay Fill	4,000
Penberton Dr	Fox Hunt to Waldenwood (east)	4-10	0	0-8	0	Clay Fill/Clay/ Clayey Silt/Sand	4,500
Rock Creek	Northern End to Huntington	2-3	0	9-15	0	Sand Fill/Clay Fill/ Clay/Sand	5,500
S. State	Washington to S. University	3-18	(4 of brick at B-2 and B-3)	3-17	9 (B-4)	Sand Fill/Clay Fill/ Clay/Sand	5,500
N. Thayer	E. Huron to Kingsley	3-6	12 (at B-4)	8-12 (B-1, B-4 & B-5)	3-19 (B-2 & B-3)	Sand Fill/Clay/ Silty & Clayey Sand	6,000
Yellowstone	Bluett to Bluett	5-9	0	3-9	7 (B-2_)	Clay Fill/Clay	4,500

6.0 GENERAL CONSTRUCTION PROCEDURES / RECOMMENDATIONS

6.1. General

Experience indicates that variations in soil conditions are encountered during construction. In order to permit correlation between the soil boring data and the actual soil conditions encountered during construction, it is recommended that a continuous inspection and review of the soil related phases of construction work be carried out. We recommend the site preparation activities, engineered fill placement and pavement construction be observed by a qualified engineering technician. The technician should perform the appropriate type and number of field tests needed to verify compliance with construction specifications and that the pavement subgrade soils are suitable.

The existing silty soils at the site could be potentially troublesome for some earthwork operations, depending on the prevailing moisture content. These soils have relatively poor drainage characteristics and are susceptible to ponding, subsequent softening and pumping due to construction traffic. During a wet season or periods of heavy precipitation, the silty and clayey subgrade soils may become unstable and provide limited support for some rubber-tired construction equipment. If pumping of the subgrade occurs due to construction traffic, an evaluation of the site and construction procedures should be made by a geotechnical engineer.

6.2. Groundwater Control

Based on the observed groundwater conditions in the test borings, no significant groundwater related problems are anticipated during pavement construction. However, the conditions encountered at the majority of the boring locations are conducive to the development of perched water accumulations within the granular soils. If perched accumulations occur, some groundwater seepage could be encountered.

Proper groundwater control measures should be maintained during all earthwork activities in order to limit the disturbance of the subgrade soils. These measures should include a provision of temporary drainage ditches to discharge any perched water outside the construction area.

For relatively shallow excavations, it appears that minor perched groundwater accumulations, if encountered, should be controllable by conventional pumping methods from standard sump pits extending into the natural clay soils.

Any groundwater related problems should be evaluated in the field by a qualified geotechnical engineer so that the best remedial measures can be determined.

APPENDIX

Boring Logs
Summary of Laboratory Test Results
General Notes for Soil Classification

Boring Logs



CTI and Associates Inc

BORING NUMBER: Division B-1

PAGE 1 OF 1

CLIENT City of Ann Arbor
PROJECT NUMBER 3122040060-1
DATE STARTED 10/10/12 **COMPLETED** 10/10/12
DRILLING CONTRACTOR Stearns Drilling
DRILLING METHOD 2-1/4 inch HSA
LOGGED BY G. Geerlings **CHECKED BY** T. Marsik
NOTES Boring backfilled with auger cuttings and patched.

PROJECT NAME 2012 Ann Arbor Misc. Geotechnical Services - North Area Borings
PROJECT LOCATION Ann Arbor, Michigan
GROUND ELEVATION N/A
GROUND WATER LEVELS:
DURING DRILLING None
AFTER DRILLING None
COLLAPSE DEPTH 3' 6"

DEPTH (ft)	GRAPHIC LOG	MATERIAL DESCRIPTION	SAMPLE TYPE NUMBER	RECOVERY % (RQD)	BLOW COUNTS (N VALUE)	POCKET PEN. (tsf) UNC. STRENGTH (psf)	NATURAL MOISTURE CONTENT (%)	▲ SPT N VALUE ▲		
								20	40	60
0.0		6 inches of ASPHALT PAVEMENT								
		6 inches of CONCRETE PAVEMENT								
		6 inches of brown moist fine to medium SAND with some gravel and silt - (FILL)								
2.5		Reddish-brown moist loose silty fine SAND with some gravel and clay - (SM)	SS 1	100	5-3-7 (10)					
5.0			SS 2	56	3-3-2 (5)					

Bottom of borehole at 5.0 feet.

Boring performed 8' east of curb, 50' north of Washington Street



CTI and Associates Inc

BORING NUMBER: Division B-2

PAGE 1 OF 1

CLIENT City of Ann Arbor
PROJECT NUMBER 3122040060-1
DATE STARTED 10/10/12 **COMPLETED** 10/10/12
DRILLING CONTRACTOR Stearns Drilling
DRILLING METHOD 2-1/4 inch HSA
LOGGED BY G. Geerlings **CHECKED BY** T. Marsik
NOTES Boring backfilled with auger cuttings and patched.

PROJECT NAME 2012 Ann Arbor Misc. Geotechnical Services - North Area Borings
PROJECT LOCATION Ann Arbor, Michigan
GROUND ELEVATION N/A
GROUND WATER LEVELS:
DURING DRILLING None
AFTER DRILLING None
COLLAPSE DEPTH 3' 6"

DEPTH (ft)	GRAPHIC LOG	MATERIAL DESCRIPTION	SAMPLE TYPE NUMBER	RECOVERY % (RQD)	BLOW COUNTS (N VALUE)	POCKET PEN. (tsf) UNC. STRENGTH (psf)	NATURAL MOISTURE CONTENT (%)	▲ SPT N VALUE ▲										
								20	40	60	80							
0.0		6 inches of ASPHALT PAVEMENT																
		6 inches of CONCRETE PAVEMENT																
		6 inches of brown moist fine to medium SAND with some gravel and silt - (FILL)																
2.5		Brown moist medium dense silty fine SAND with some gravel and clay and occasional clay lenses - (SM)	SS 1	100	5-6-4 (10)													
5.0			SS 2	61	4-4-6 (10)													

Bottom of borehole at 5.0 feet.

Boring performed 10' east of curb, 90' north of Liberty Street



CTI and Associates Inc

BORING NUMBER: Division B-3

PAGE 1 OF 1

CLIENT City of Ann Arbor
PROJECT NUMBER 3122040060-1
DATE STARTED 10/10/12 **COMPLETED** 10/10/12
DRILLING CONTRACTOR Stearns Drilling
DRILLING METHOD 2-1/4 inch HSA
LOGGED BY G. Geerlings **CHECKED BY** T. Marsik
NOTES Boring backfilled with auger cuttings and patched.

PROJECT NAME 2012 Ann Arbor Misc. Geotechnical Services - North Area Borings
PROJECT LOCATION Ann Arbor, Michigan
GROUND ELEVATION N/A
GROUND WATER LEVELS:
DURING DRILLING None
AFTER DRILLING None
COLLAPSE DEPTH 3' 6"

DEPTH (ft)	GRAPHIC LOG	MATERIAL DESCRIPTION	SAMPLE TYPE NUMBER	RECOVERY % (RQD)	BLOW COUNTS (N VALUE)	POCKET PEN. (tsf) UNC. STRENGTH (psf)	NATURAL MOISTURE CONTENT (%)	▲ SPT N VALUE ▲	
								PL	MC LL
0.0		4 inches of ASPHALT PAVEMENT						20	40 60 80
		10 inches of CONCRETE PAVEMENT						20	40 60 80
		10 inches of gray moist crushed LIMESTONE - (FILL)	SS 1	100	11-8-9 (17)				
2.5		Brown moist medium dense fine to medium SAND with some gravel and trace of silt - (SP)							
			SS 2	100	10-5-6 (11)				
5.0									

Bottom of borehole at 5.0 feet.

Boring performed 8' west of curb, at 307 S. Division Street



CTI and Associates Inc

BORING NUMBER: Division B-4

PAGE 1 OF 1

CLIENT City of Ann Arbor
PROJECT NUMBER 3122040060-1
DATE STARTED 10/10/12 **COMPLETED** 10/10/12
DRILLING CONTRACTOR Stearns Drilling
DRILLING METHOD 2-1/4 inch HSA
LOGGED BY G. Geerlings **CHECKED BY** T. Marsik
NOTES Boring backfilled with auger cuttings and patched.

PROJECT NAME 2012 Ann Arbor Misc. Geotechnical Services - North Area Borings
PROJECT LOCATION Ann Arbor, Michigan
GROUND ELEVATION N/A
GROUND WATER LEVELS:
DURING DRILLING None
AFTER DRILLING None
COLLAPSE DEPTH 3' 6"

DEPTH (ft)	GRAPHIC LOG	MATERIAL DESCRIPTION	SAMPLE TYPE NUMBER	RECOVERY % (RQD)	BLOW COUNTS (N VALUE)	POCKET PEN. (tsf) UNC. STRENGTH (psf)	NATURAL MOISTURE CONTENT (%)	▲ SPT N VALUE ▲		
								20	40	60
0.0		4 inches of ASPHALT PAVEMENT								
		8 inches of CONCRETE PAVEMENT								
		6 inches of gray moist crushed LIMESTONE - (FILL)								
2.5		Brown moist medium dense fine to medium SAND with some gravel and trace of silt - (SP)	SS 1	100	8-9-8 (17)					
5.0		Brown moist medium dense silty fine to medium SAND with some gravel and clay - (SM)	SS 2	67	6-8-10 (18)					

Bottom of borehole at 5.0 feet.

Boring performed 8' west of curb, at 321 S. Division Street



CTI and Associates Inc

BORING NUMBER: Division B-5

PAGE 1 OF 1

CLIENT City of Ann Arbor
PROJECT NUMBER 3122040060-1
DATE STARTED 10/10/12 **COMPLETED** 10/10/12
DRILLING CONTRACTOR Stearns Drilling
DRILLING METHOD 2-1/4 inch HSA
LOGGED BY G. Geerlings **CHECKED BY** T. Marsik
NOTES Boring backfilled with auger cuttings and patched.

PROJECT NAME 2012 Ann Arbor Misc. Geotechnical Services - North Area Borings
PROJECT LOCATION Ann Arbor, Michigan
GROUND ELEVATION N/A
GROUND WATER LEVELS:
DURING DRILLING None
AFTER DRILLING None
COLLAPSE DEPTH 3' 6"

DEPTH (ft)	GRAPHIC LOG	MATERIAL DESCRIPTION	SAMPLE TYPE NUMBER	RECOVERY % (RQD)	BLOW COUNTS (N VALUE)	POCKET PEN. (tsf) UNC. STRENGTH (psf)	NATURAL MOISTURE CONTENT (%)	▲ SPT N VALUE ▲		
								20	40	60
0.0		2 inches of ASPHALT PAVEMENT 12 inches of CONCRETE PAVEMENT								
		5 inches of moist gray crushed LIMESTONE - (FILL)								
2.5		Brown moist medium dense fine to medium SAND with some gravel and trace of silt - (SP)	SS 1	100	8-13-12 (25)					
5.0			SS 2	89	4-5-5 (10)					

Bottom of borehole at 5.0 feet.

Boring performed 8' west of curb, 10' south of driveway to 335 S. Division Street



CTI and Associates Inc

BORING NUMBER: Division B-6

PAGE 1 OF 1

CLIENT City of Ann Arbor
PROJECT NUMBER 3122040060-1
DATE STARTED 10/10/12 **COMPLETED** 10/10/12
DRILLING CONTRACTOR Stearns Drilling
DRILLING METHOD 2-1/4 inch HSA
LOGGED BY G. Geerlings **CHECKED BY** T. Marsik
NOTES Boring backfilled with auger cuttings and patched.

PROJECT NAME 2012 Ann Arbor Misc. Geotechnical Services - North Area Borings
PROJECT LOCATION Ann Arbor, Michigan
GROUND ELEVATION N/A
GROUND WATER LEVELS:
DURING DRILLING None
AFTER DRILLING None
COLLAPSE DEPTH 3' 6"

DEPTH (ft)	GRAPHIC LOG	MATERIAL DESCRIPTION	SAMPLE TYPE NUMBER	RECOVERY % (RQD)	BLOW COUNTS (N VALUE)	POCKET PEN. (tsf) UNC. STRENGTH (psf)	NATURAL MOISTURE CONTENT (%)	▲ SPT N VALUE ▲	
								PL	MC LL
0.0		8 inches of ASPHALT PAVEMENT						20	40 60 80
		4 inches of CONCRETE PAVEMENT						20	40 60 80
		6 inches of dark gray moist crushed LIMESTONE - (FILL)						20	40 60 80
2.5		Reddish-brown moist stiff sandy CLAY with silt and some gravel - (CL)	SS 1	100	7-3-4 (7)		13		
5.0		Brown moist loose clayey fine to medium SAND with some gravel - (SC)	SS 2	17	3-3-6 (9)				

Bottom of borehole at 5.0 feet.

Boring performed 18' west of curb, at 413 S. Division Street



CTI and Associates Inc

BORING NUMBER: Division B-7

CLIENT City of Ann Arbor
PROJECT NUMBER 3122040060-1
DATE STARTED 10/10/12 **COMPLETED** 10/10/12
DRILLING CONTRACTOR Stearns Drilling
DRILLING METHOD 2-1/4 inch HSA
LOGGED BY G. Geerlings **CHECKED BY** T. Marsik
NOTES Boring backfilled with auger cuttings and patched.

PROJECT NAME 2012 Ann Arbor Misc. Geotechnical Services - North Area Borings
PROJECT LOCATION Ann Arbor, Michigan
GROUND ELEVATION N/A
GROUND WATER LEVELS:
DURING DRILLING None
AFTER DRILLING None
COLLAPSE DEPTH 3' 6"

DEPTH (ft)	GRAPHIC LOG	MATERIAL DESCRIPTION	SAMPLE TYPE NUMBER	RECOVERY % (RQD)	BLOW COUNTS (N VALUE)	POCKET PEN. (tsf) UNC. STRENGTH (psf)	NATURAL MOISTURE CONTENT (%)	▲ SPT N VALUE ▲						
								20	40	60	80			
0.0		14 inches of ASPHALT PAVEMENT												
2.5		6 inches of dark brown moist fine to medium SAND with some gravel and silt - (FILL) Dark brown to reddish-brown moist sandy CLAY with silt, some gravel and traces of sand and organics - (FILL)	SS 1	100	2-2-2 (4)									
5.0		Brown moist loose fine to medium SAND with some gravel and silt - (SP-SM)	SS 2	89	2-3-4 (7)									

Bottom of borehole at 5.0 feet.

Boring performed 18' west of curb, at entrance to 443 S. Division Street



CTI and Associates Inc

BORING NUMBER: Division B-8

PAGE 1 OF 1

CLIENT City of Ann Arbor
PROJECT NUMBER 3122040060-1
DATE STARTED 10/10/12 **COMPLETED** 10/10/12
DRILLING CONTRACTOR Stearns Drilling
DRILLING METHOD 2-1/4 inch HSA
LOGGED BY G. Geerlings **CHECKED BY** T. Marsik
NOTES Boring backfilled with auger cuttings and patched.

PROJECT NAME 2012 Ann Arbor Misc. Geotechnical Services - North Area Borings
PROJECT LOCATION Ann Arbor, Michigan
GROUND ELEVATION N/A
GROUND WATER LEVELS:
DURING DRILLING None
AFTER DRILLING None
COLLAPSE DEPTH 3' 6"

DEPTH (ft)	GRAPHIC LOG	MATERIAL DESCRIPTION	SAMPLE TYPE NUMBER	RECOVERY % (RQD)	BLOW COUNTS (N VALUE)	POCKET PEN. (tsf) UNC. STRENGTH (psf)	NATURAL MOISTURE CONTENT (%)	▲ SPT N VALUE ▲									
								20	40	60	80						
0.0		8 inches of ASPHALT PAVEMENT															
		6 inches of CONCRETE PAVEMENT															
		4 inches of dark gray moist crushed LIMESTONE - (FILL)															
		Brown moist loose fine to coarse SAND with gravel and some silt - (SP-SM)	SS 1	94	6-5-4 (9)												
2.5																	
			SS 2	33	3-3-3 (6)												
5.0																	

Bottom of borehole at 5.0 feet.

Boring performed 18' west of curb, 15' south of driveway to 522 S. Division Street



CTI and Associates Inc

BORING NUMBER: Division B-9

PAGE 1 OF 1

CLIENT City of Ann Arbor
PROJECT NUMBER 3122040060-1
DATE STARTED 10/10/12 **COMPLETED** 10/10/12
DRILLING CONTRACTOR Stearns Drilling
DRILLING METHOD 2-1/4 inch HSA
LOGGED BY G. Geerlings **CHECKED BY** T. Marsik
NOTES Boring backfilled with auger cuttings and patched.

PROJECT NAME 2012 Ann Arbor Misc. Geotechnical Services - North Area Borings
PROJECT LOCATION Ann Arbor, Michigan
GROUND ELEVATION N/A
GROUND WATER LEVELS:
DURING DRILLING None
AFTER DRILLING None
COLLAPSE DEPTH 3' 6"

DEPTH (ft)	GRAPHIC LOG	MATERIAL DESCRIPTION	SAMPLE TYPE NUMBER	RECOVERY % (RQD)	BLOW COUNTS (N VALUE)	POCKET PEN. (tsf) UNC. STRENGTH (psf)	NATURAL MOISTURE CONTENT (%)	▲ SPT N VALUE ▲	
								20	40 60 80
0.0		5 inches of ASPHALT PAVEMENT						PL	MC LL
		12 inches of CONCRETE PAVEMENT						20 40 60 80	
		7 inches of gray moist crushed LIMESTONE - (FILL)	SS 1	100	6-7-7 (14)				
2.5		Brown moist medium dense fine to coarse SAND with gravel and some silt - (SP-SM)							
		Brown moist medium density silty fine to medium SAND with some gravel and clay - (SM)	SS 2	100	4-7-10 (17)				
5.0									

Bottom of borehole at 5.0 feet.

Boring performed 4' west of curb, at entrance to Krazy Jim's Blimpy Burger

**CITY OF ANN ARBOR
PREVAILING WAGE DECLARATION OF COMPLIANCE**

The "wage and employment requirements" of Section 1:320 of Chapter 14 of Title I of the Ann Arbor City Code mandates that the city not enter any contract, understanding or other arrangement for a public improvement for or on behalf of the city unless the contract provides that all craftsmen, mechanics and laborers employed directly on the site in connection with said improvements, including said employees of subcontractors, shall receive the prevailing wage for the corresponding classes of craftsmen, mechanics and laborers, as determined by statistics for the Ann Arbor area compiled by the United States Department of Labor. Where the contract and the Ann Arbor City Code are silent as to definitions of terms required in determining contract compliance with regard to prevailing wages, the definitions provided in the Davis-Bacon Act as amended (40 U.S.C. 278-a to 276-a-7) for the terms shall be used. Further, to the extent that any employees of the contractor providing services under this contract are not part of the class of craftsmen, mechanics and laborers who receive a prevailing wage in conformance with section 1:320 of Chapter 14 of Title I of the Code of the City of Ann Arbor, employees shall be paid a prescribed minimum level of compensation (i.e. Living Wage) for the time those employees perform work on the contract in conformance with section 1:815 of Chapter 23 of Title I of the Code of the City of Ann Arbor.

At the request of the city, any contractor or subcontractor shall provide satisfactory proof of compliance with this provision.

The Contractor agrees:

- (a) To pay each of its employees whose wage level is required to comply with federal, state or local prevailing wage law, for work covered or funded by this contract with the City,
- (b) To require each subcontractor performing work covered or funded by this contract with the City to pay each of its employees the applicable prescribed wage level under the conditions stated in subsection (a) or (b) above.
- (c) To provide to the City payroll records or other documentation within ten (10) business days from the receipt of a request by the City.
- (d) To permit access to work sites to City representatives for the purposes of monitoring compliance, and investigating complaints or non-compliance.

The undersigned states that he/she has the requisite authority to act on behalf of his/her employer in these matters and has offered to provide the services in accordance with the terms of the wage and employment provisions of the Chapter 14 of the Ann Arbor City Code. The undersigned certifies that he/she has read and is familiar with the terms of Section 1:320 of Chapter 14 of the Ann Arbor City Code and by executing this Declaration of Compliance obligates his/her employer and any subcontractor employed by it to perform work on the contract to the wage and employment requirements stated herein. The undersigned further acknowledges and agrees that if it is found to be in violation of the wage and employment requirements of Section 1:320 of the Chapter 14 of the Ann Arbor City Code it shall have been deemed a material breach of the terms of the contract and grounds for termination of same by the City.

CADILLAC ASPHALT LLC
Company Name
[Signature] 3/30/17
Signature of Authorized Representative Date
WANDA DWYER, AREA MGR.
Print Name and Title
857 S. WAGNER RD, ANN ARBOR, MI 48103
Address, City, State, Zip
(734) 216-1006 / WANDA.DWYER@mipmc.com
Phone/Email address

Questions about this form? Contact Procurement Office City of Ann Arbor Phone: 734/794-6500

**CITY OF ANN ARBOR
LIVING WAGE ORDINANCE**

RATE EFFECTIVE APRIL 30, 2017 - ENDING APRIL 29, 2018

\$13.13 per hour

If the employer provides health care benefits*

\$14.65 per hour

If the employer does **NOT** provide health care benefits*

Employers providing services to or for the City of Ann Arbor or recipients of grants or financial assistance from the City of Ann Arbor for a value of more than \$10,000 in a twelve-month period of time must pay those employees performing work on a City of Ann Arbor contract or grant, the above living wage.

ENFORCEMENT

The City of Ann Arbor may recover back wages either administratively or through court action for the employees that have been underpaid in violation of the law. Persons denied payment of the living wage have the right to bring a civil action for damages in addition to any action taken by the City.

Violation of this Ordinance is punishable by fines of not more than \$500/violation plus costs, with each day being considered a separate violation. Additionally, the City of Ann Arbor has the right to modify, terminate, cancel or suspend a contract in the event of a violation of the Ordinance.

* Health Care benefits include those paid for by the employer or making an employer contribution toward the purchase of health care. The employee contribution must not exceed \$.50 an hour for an average work week; and the employer cost or contribution must equal no less than \$1/hr for the average work week.

The Law Requires Employers to Display This Poster Where Employees Can Readily See It.

**For Additional Information or to File a Complaint Contact:
Colin Spencer at 734/794-6500 or cspencer@a2gov.org**

**CITY OF ANN ARBOR
LIVING WAGE ORDINANCE DECLARATION OF COMPLIANCE**

The Ann Arbor Living Wage Ordinance (Section 1:811-1:821 of Chapter 23 of Title I of the Code) requires that an employer who is (a) a contractor providing services to or for the City for a value greater than \$10,000 for any twelve-month contract term, or (b) a recipient of federal, state, or local grant funding administered by the City for a value greater than \$10,000, or (c) a recipient of financial assistance awarded by the City for a value greater than \$10,000, shall pay its employees a prescribed minimum level of compensation (i.e., Living Wage) for the time those employees perform work on the contract or in connection with the grant or financial assistance. The Living Wage must be paid to these employees for the length of the contract/program.

Companies employing fewer than 5 persons and non-profits employing fewer than 10 persons are exempt from compliance with the Living Wage Ordinance. If this exemption applies to your company/non-profit agency please check here No. of employees

The Contractor or Grantee agrees:

- (a) To pay each of its employees whose wage level is not required to comply with federal, state or local prevailing wage law, for work covered or funded by a contract with or grant from the City, no less than the Living Wage. The current Living Wage is defined as \$13.13/hour for those employers that provide employee health care (as defined in the Ordinance at Section 1:815 Sec. 1 (a)), or no less than \$14.65/hour for those employers that do not provide health care. The Contractor or Grantor understands that the Living Wage is adjusted and established annually on April 30 in accordance with the Ordinance and covered employers shall be required to pay the adjusted amount thereafter to be in compliance (Section 1:815(3)).

Check the applicable box below which applies to your workforce

Employees who are assigned to any covered City contract/grant will be paid at or above the applicable living wage without health benefits

Employees who are assigned to any covered City contract/grant will be paid at or above the applicable living wage with health benefits

- (b) To post a notice approved by the City regarding the applicability of the Living Wage Ordinance in every work place or other location in which employees or other persons contracting for employment are working.
- (c) To provide to the City payroll records or other documentation within ten (10) business days from the receipt of a request by the City.
- (d) To permit access to work sites to City representatives for the purposes of monitoring compliance, and investigating complaints or non-compliance.
- (e) To take no action that would reduce the compensation, wages, fringe benefits, or leave available to any employee covered by the Living Wage Ordinance or any person contracted for employment and covered by the Living Wage Ordinance in order to pay the living wage required by the Living Wage Ordinance.

The undersigned states that he/she has the requisite authority to act on behalf of his/her employer in these matters and has offered to provide the services or agrees to accept financial assistance in accordance with the terms of the Living Wage Ordinance. The undersigned certifies that he/she has read and is familiar with the terms of the Living Wage Ordinance, obligates the Employer/Grantee to those terms and acknowledges that if his/her employer is found to be in violation of Ordinance it may be subject to civil penalties and termination of the awarded contract or grant of financial assistance.

CADILLAC ASPHALT LLC 857 S. WAGNER RD
 Company Name Street Address

[Signature] 3/30/17 ANN ARBOR, MI 48103
 Signature of Authorized Representative Date City, State, Zip

WANDA DWYER, AREA MGR. (734) 216-7006/WANDA.DWYER@mipmc.com
 Print Name and Title Phone/Email address



Vendor Conflict of Interest Disclosure Form

All vendors interested in conducting business with the City of Ann Arbor must complete and return the Vendor Conflict of Interest Disclosure Form in order to be eligible to be awarded a contract. Please note that all vendors are subject to comply with the City of Ann Arbor's conflict of interest policies as stated within the certification section below.

If a vendor has a relationship with a City of Ann Arbor official or employee, an immediate family member of a City of Ann Arbor official or employee, the vendor shall disclose the information required below.

1. No City official or employee or City employee's immediate family member has an ownership interest in vendor's company or is deriving personal financial gain from this contract.
2. No retired or separated City official or employee who has been retired or separated from the City for less than one (1) year has an ownership interest in vendor's Company.
3. No City employee is contemporaneously employed or prospectively to be employed with the vendor.
4. Vendor hereby declares it has not and will not provide gifts or hospitality of any dollar value or any other gratuities to any City employee or elected official to obtain or maintain a contract.
5. Please note any exceptions below:

Conflict of Interest Disclosure*	
Name of City of Ann Arbor employees, elected officials or immediate family members with whom there may be a potential conflict of interest.	<input type="checkbox"/> Relationship to employee <input type="checkbox"/> Interest in vendor's company <input type="checkbox"/> Other (please describe in box below)
NONE	

*Disclosing a potential conflict of interest does not disqualify vendors. In the event vendors do not disclose potential conflicts of interest and they are detected by the City, vendor will be exempt from doing business with the City.

I certify that this Conflict of Interest Disclosure has been examined by me and that its contents are true and correct to my knowledge and belief and I have the authority to so certify on behalf of the Vendor by my signature below:		
CADILLAC ASPHALT LLC	(734) 216-7006	
Vendor Name	Vendor Phone Number	
	3/30/17	WANDA DWYER
Signature of Vendor Authorized Representative	Date	Printed Name of Vendor Authorized Representative

Questions about this form? Contact Procurement Office City of Ann Arbor Phone: 734/794-6500, procurement@a2gov.org

CITY OF ANN ARBOR NON-DISCRIMINATION ORDINANCE

Relevant provisions of Chapter 112, Nondiscrimination, of the Ann Arbor City Code are included below. You can review the entire ordinance at [www. a2gov.org/departments/city-clerk](http://www.a2gov.org/departments/city-clerk)

Intent: It is the intent of the city that no individual be denied equal protection of the laws; nor shall any individual be denied the enjoyment of his or her civil or political rights or be discriminated against because of actual or perceived age, arrest record, color, disability, educational association, familial status, family responsibilities, gender expression, gender identity, genetic information, height, HIV status, marital status, national origin, political beliefs, race, religion, sex, sexual orientation, source of income, veteran status, victim of domestic violence or stalking, or weight.

Discriminatory Employment Practices: No person shall discriminate in the hire, employment, compensation, work classifications, conditions or terms, promotion or demotion, or termination of employment of any individual. No person shall discriminate in limiting membership, conditions of membership or termination of membership in any labor union or apprenticeship program.

Discriminatory Effects: No person shall adopt, enforce or employ any policy or requirement which has the effect of creating unequal opportunities according to actual or perceived age, arrest record, color, disability, educational association, familial status, family responsibilities, gender expression, gender identity, genetic information, height, HIV status, marital status, national origin, political beliefs, race, religion, sex, sexual orientation, source of income, veteran status, victim of domestic violence or stalking, or weight for an individual to obtain housing, employment or public accommodation, except for a bona fide business necessity. Such a necessity does not arise due to a mere inconvenience or because of suspected objection to such a person by neighbors, customers or other persons.

Nondiscrimination by City Contractors: All contractors proposing to do business with the City of Ann Arbor shall satisfy the contract compliance administrative policy adopted by the City Administrator in accordance with the guidelines of this section. All city contractors shall ensure that applicants are employed and that employees are treated during employment in a manner which provides equal employment opportunity and tends to eliminate inequality based upon any classification protected by this chapter. All contractors shall agree not to discriminate against an employee or applicant for employment with respect to hire, tenure, terms, conditions, or privileges of employment, or a matter directly or indirectly related to employment, because of any applicable protected classification. All contractors shall be required to post a copy of Ann Arbor's Non-Discrimination Ordinance at all work locations where its employees provide services under a contract with the city.

Complaint Procedure: If any individual has a grievance alleging a violation of this chapter, he/she has 180 calendar days from the date of the individual's knowledge of the allegedly discriminatory action or 180 calendar days from the date when the individual should have known of the alleged discriminatory action to file a complaint with the city's Human Rights Commission. If an individual fails to file a complaint alleging a violation of this chapter within the specified time frame, the complaint will not be considered by the Human Rights Commission. The complaint should be made in writing to the Human Rights Commission. The complaint may be filed in person with the City Clerk, by e-mail (hrc@a2gov.org), by phone (734-794-6141) or by mail (Ann Arbor Human Rights Commission, PO Box 8647, Ann Arbor, MI 48107). The complaint must contain information about the alleged discrimination, such as name, address, phone number of the complainant and location, date and description of the alleged violation of this chapter.

Private Actions For Damages or Injunctive Relief: To the extent allowed by law, an individual who is the victim of discriminatory action in violation of this chapter may bring a civil action for appropriate injunctive relief or damages or both against the person(s) who acted in violation of this chapter.

THIS IS AN OFFICIAL GOVERNMENT NOTICE AND
MUST BE DISPLAYED WHERE EMPLOYEES CAN READILY SEE IT.

**CITY OF ANN ARBOR
DECLARATION OF COMPLIANCE**

Non-Discrimination Ordinance

The "non discrimination by city contractors" provision of the City of Ann Arbor Non-Discrimination Ordinance (Ann Arbor City Code Chapter 112, Section 9:158) requires all contractors proposing to do business with the City to treat employees in a manner which provides equal employment opportunity and does not discriminate against any of their employees, any City employee working with them, or any applicant for employment on the basis of actual or perceived age, arrest record, color, disability, educational association, familial status, family responsibilities, gender expression, gender identity, genetic information, height, HIV status, marital status, national origin, political beliefs, race, religion, sex, sexual orientation, source of income, veteran status, victim of domestic violence or stalking, or weight. It also requires that the contractors include a similar provision in all subcontracts that they execute for City work or programs.

In addition the City Non-Discrimination Ordinance requires that all contractors proposing to do business with the City of Ann Arbor must satisfy the contract compliance administrative policy adopted by the City Administrator. A copy of that policy may be obtained from the Purchasing Manager

The Contractor agrees:

- (a) To comply with the terms of the City of Ann Arbor's Non-Discrimination Ordinance and contract compliance administrative policy.
- (b) To post the City of Ann Arbor's Non-Discrimination Ordinance Notice in every work place or other location in which employees or other persons are contracted to provide services under a contract with the City.
- (c) To provide documentation within the specified time frame in connection with any workforce verification, compliance review or complaint investigation.
- (d) To permit access to employees and work sites to City representatives for the purposes of monitoring compliance, or investigating complaints of non-compliance.

The undersigned states that he/she has the requisite authority to act on behalf of his/her employer in these matters and has offered to provide the services in accordance with the terms of the Ann Arbor Non-Discrimination Ordinance. The undersigned certifies that he/she has read and is familiar with the terms of the Non-Discrimination Ordinance, obligates the Contractor to those terms and acknowledges that if his/her employer is found to be in violation of Ordinance it may be subject to civil penalties and termination of the awarded contract.

CADILLAC ASPHALT LLC

Company Name

Wanda Dwyer 3/30/17

Signature of Authorized Representative

Date

WANDA DWYER, AREA MGR.

Print Name and Title

857 S. WAGNER RD, ANN ARBOR

Address, City, State, Zip

(734) 216-7006 / WANDA.DWYER@miPMC.com

Phone/Email address

Questions about the Notice or the City Administrative Policy, Please contact:
Procurement Office of the City of Ann Arbor
(734) 794-6500

Date _____

I, _____ (Name of Signatory Party) _____ (Title)

do hereby state:

(1) That I pay or supervise the payment of the persons employed by

_____, (Contractor or Subcontractor) _____ on the _____ day of _____, and ending the _____ day of _____, that during the payroll period commencing on the _____ day of _____, _____ (Building or Work) _____ all persons employed on said project have been paid the full weekly wages earned, that no rebates have been or will be made either directly or indirectly to or on behalf of said _____ (Contractor or Subcontractor) _____ from the full

weekly wages earned by any person and that no deductions have been made either directly or indirectly from the full wages earned by any person, other than permissible deductions as defined in Regulations, Part 3 (29 C.F.R. Subtitle A), issued by the Secretary of Labor under the Copeland Act, as amended (48 Stat. 948, 63 Stat. 108, 72 Stat. 967; 76 Stat. 357; 40 U.S.C. § 3145), and described below:

(2) That any payrolls otherwise under this contract required to be submitted for the above period are correct and complete; that the wage rates for laborers or mechanics contained therein are not less than the applicable wage rates contained in any wage determination incorporated into the contract; that the classifications set forth therein for each laborer or mechanic conform with the work he performed.

(3) That any apprentices employed in the above period are duly registered in a bona fide apprenticeship program registered with a State apprenticeship agency recognized by the Bureau of Apprenticeship and Training, United States Department of Labor, or if no such recognized agency exists in a State, are registered with the Bureau of Apprenticeship and Training, United States Department of Labor.

(4) That:

(a) WHERE FRINGE BENEFITS ARE PAID TO APPROVED PLANS, FUNDS, OR PROGRAMS

— in addition to the basic hourly wage rates paid to each laborer or mechanic listed in the above referenced payroll, payments of fringe benefits as listed in the contract have been or will be made to appropriate programs for the benefit of such employees, except as noted in section 4(c) below.

(b) WHERE FRINGE BENEFITS ARE PAID IN CASH

— Each laborer or mechanic listed in the above referenced payroll has been paid, as indicated on the payroll, an amount not less than the sum of the applicable basic hourly wage rate plus the amount of the required fringe benefits as listed in the contract, except as noted in section 4(c) below.

(c) EXCEPTIONS

EXCEPTION (CRAFT)	EXPLANATION

REMARKS:

NAME AND TITLE	SIGNATURE
THE WILLFUL FALSIFICATION OF ANY OF THE ABOVE STATEMENTS MAY SUBJECT THE CONTRACTOR, OR SUBCONTRACTOR TO CIVIL OR CRIMINAL PROSECUTION. SEE SECTION 1001 OF TITLE 18 AND SECTION 231 OF TITLE 31 OF THE UNITED STATES CODE.	