

PLANNING AND DEVELOPMENT SERVICES STAFF REPORT

For Planning Commission Meeting of November 19, 2013

**SUBJECT: Germain Motors Site Plan for City Council Approval
(2575 South State Street)
File No. SP13-048**

PROPOSED CITY PLANNING COMMISSION MOTION

The Ann Arbor City Planning Commission hereby recommends that the Mayor and City Council approve the Germain Motors Site Plan, subject to variances for parking lot and landscape modifications being granted by the Zoning Board of Appeals.

PROPOSED CITY PLANNING COMMISSION MOTION

The Ann Arbor City Planning Commission hereby approves the proposed landscape modifications in order to use existing vegetation to count toward the interior parking lot landscaping requirements and eliminate the requirement for depressed landscape islands, according to Chapter 62 (Landscape and Screening Ordinance), Section 5:608(2)(c).

STAFF RECOMMENDATION

Staff recommends that the rezoning and site plan be **postponed** to give the petitioner an opportunity to address staff comments.

LOCATION

The site is located on east side of South State Street at the corner of Oakbrook (South Area, Malletts Creek Watershed).

DESCRIPTION OF PETITION

The petitioner seeks to construct additions to two of the three existing buildings on the site and construct an additional 248 vehicle parking spaces. The three buildings on site are composed of auto showrooms and service functions for Porsche/Audi, Volkswagen and Honda. As part of this project, some of the dealerships will switch buildings: Volkswagen will occupy the northernmost building; Porsche/Audi will occupy the middle building; and Honda will remain in the southernmost building.

The petitioner is proposing a 4,877 sf addition to the Volkswagen building, for a total building size of 18,722 sf. A 6,429 sf addition is proposed to the Porsche/Audi building, for a total building size of 31,097 sf. The Honda building will not have any building additions and will remain 36,101 sf.

The site currently contains 791 vehicle parking spaces, with an additional 248 parking spaces proposed for a total of 1,039 parking spaces. The majority of the site's parking spaces are used for vehicle display and storage. The additional vehicle parking spaces will be located along the southern half of the S. State Street frontage, along the Oakbrook Drive frontage and in the rear car storage lots. The vehicle storage area located in the rear of the site is comprised of two large parking areas divided by an engineered vegetated slope and retaining wall.

The petitioner is requesting three variances from Chapter 59 (Off-Street Parking) in order to allow tandem parking, reduced aisle widths and exceed the maximum percentage (30%) of small car parking spaces. The petitioner is also requesting one variance from Chapter 62 to eliminate the requirement for required interior landscape islands in the car inventory and display areas.

A total of 28 bicycle spaces are required: 14 Class C bicycle spaces and 14 Class A spaces. All Class C spaces will be provided near the three building entrances, and the Class A spaces will be provided inside each building.

There currently are three curb cuts on South State Street providing access to the site; no modifications to the drives are proposed. Pedestrian connections have been added from the South State Street sidewalk to building entrances, as well as internal sidewalks in between buildings and customer parking areas on the site.

There are existing storm water facilities on the east side of the site and an adjacent site (same owner) across Boardwalk to the east of the site. The storm water facilities are under the jurisdiction of the Washtenaw County Water Resources Commissioner (WCWRC). Based on the total of impervious surface on the site, the petitioner is required to provide first flush, bankfull and 100 year storm detention capacity. The WCWRC has reviewed and approved the storm water plan, which includes minor modifications to the existing system and maintenance items to be addressed during construction.

There are four landmark trees located on the north side of the site, and three of these are proposed to be removed. The landmark trees are being removed for the expansion of the parking area and are not impacted by the proposed building additions. The alternatives analysis provided indicates that in order to preserve the three landmark trees and provide the amount of parking desired, a parking structure would need to be constructed. Eleven additional trees will be planted as mitigation for the landmark tree removal. There are no other natural features on the site.

The petitioner is requesting a landscape modification in order to reduce the total number of trees provided (95 provided, 103 required) within interior landscape islands and eliminate the requirement for depressed landscape islands. The petitioner's Landscape Modification Request application and justification are attached.

The project is proposed to be completed in three phases. The first phase will consist of building and parking modifications to the center building (Porsche/Audi) and the southern building

(Honda). The second phase will be the building addition and parking lot modifications to the northern building (Volkswagen). The final phase will consist of construction of the additional parking areas in the rear of the site. The estimated cost of construction will be \$5.5 million.

As required by the Citizen Participation Ordinance, the petitioner mailed out postcard notification. There were no comments submitted by the public in response to the mailing. Staff has not received any feedback from the public in regards to this petition.

COMPARISON CHART

		EXISTING	PROPOSED	REQUIRED
Zoning		M1A (Limited Light Industrial District)	M1A (Limited Light Industrial District)	M1A (Limited Light Industrial District)
Gross Lot Area		426,017 sq ft (9.78 acres)	426,017 sq ft (9.78 acres)	13,000 sq ft MIN
Maximum Gross Land Coverage of Structure		13.9%	16.1%	40% MAX
Maximum Useable Floor Area in % of Lot Area		17.5% (74,614 sq ft)	20.2% (85,920 sq ft)	75% MAX (319,512 sq ft)
Setbacks	Front – State Street (center building)	63 ft	54 ft	15 ft MIN No maximum
	Front-Oakbrook	118 ft	118 ft	15 ft MIN No maximum
	Front – Boardwalk	600+ ft	600+ ft	15 ft MIN No maximum
	Side	31 ft 6 in(north)	1 ft 9 in(north)	None
Height		24 ft MAX	24 ft	35 ft MAX
Parking – Automobiles*		331 spaces – Regular 460 spaces – Small Car 791 total spaces*	188 spaces – Regular 851 spaces – Small Car 1,039 total spaces**	430 spaces MIN No maximum
Parking – Bicycle		6 Class C	14 Class A 14 Class C	14 Class A MIN 14 Class C MIN

Note: There is no rear setback because the site has frontage on three public streets; the remaining property lines are classified as sides.

* Variances granted, May 2005

** Variances requested, December 2013 (expected ZBA meeting date)

SURROUNDING LAND USES AND ZONING

	LAND USE	ZONING
NORTH	Public School Transportation Facility and Office	M1 (Limited Industrial District)
EAST	Storm Water Facility, Railroad, Industrial	M1A (Limited Light Industrial District) and M1 (Limited Industrial District)
SOUTH	Office	O (Office District) and ORL (Office, Research and Limited Industrial District)
WEST	UM Commuter Parking Lot	O (Office District)

HISTORY

The site, with the existing Volkswagen dealership building, was annexed into the City in 1968. A site plan for the Honda dealership building was approved in February 1971. The Zoning Board of Appeals approved variances in July 1972 to allow parking in the front setback, and in August 1976 for a 24-inch tall screen and five-foot wide landscape buffer at State Street. Revised site plans were approved in September 1979 to expand the showroom and in August 1986 to expand the Honda service area. The site plan was administratively amended in November 1986 to shift the location of the detention area to the southeast corner of the site. The Zoning Board of Appeals (ZBA) granted variances in December 2000 to allow reduced aisle widths, stall dimensions, an excess of small car spaces and stacked parking only in the vehicle storage area and a revised site plan was approved in February 2001 to expand the Honda dealership. Construction was never initiated, however. In December 2003, a site plan was approved to construct a new automobile dealership building (replacing an existing structure), to add a carwash facility (for the dealership's use only), to expand the parking and vehicle storage areas, and to establish a storm water management system for the entire 12.37 acres. This construction was completed in 2004.

In April of 2005, Planning Commission denied a proposal to construct 13 stacked parking spaces within the Oakbrook Drive front setback and two vehicle display pads within the State Street front setback. The proposed project did not meet City Code requirements and could not be approved without variances from the ZBA. After Planning Commission action, the petitioner applied to the ZBA for the necessary variances to permit the modifications requested. In May 2005, the ZBA granted a variance to allow the stacked parking within the Oakbrook Drive front setback, reducing the setback from 52.70 feet to 34.48 feet. At the ZBA meeting, the petitioner indicated that due to the installation of Oakbrook Drive, the setback along the southern property line was changed from a side setback (25 feet minimum) to a front setback (52.70 feet minimum) presenting the petitioner with an unreasonable hardship. The ZBA concluded that because of the nature of this change in required setbacks, a hardship did exist and subsequently granted the requested variance. At that same meeting, the ZBA denied the variance requested to install two vehicle display pads within the front setback of State Street.

The petitioner submitted a new plan for Planning Commission approval in June of 2005. The new plan proposed adding only the 13 additional stacked parking spaces and not the vehicle display pads. This plan was approved and proposed construction was completed in 2005.

In January 2011, revisions were approved to Chapter 55(Zoning) which reduced the front setback requirement from 40 feet to 15 feet.

PLANNING BACKGROUND

This site was included in the recent South State Street Corridor Plan and recommended for office, research and limited industrial uses in the future and ORL zoning (Area 1 land use recommendations). The Plan recommends enhanced non-motorized access to buildings and addition of “gateway” features to prominent sites along the corridor. In addition, the Plan states specific recommendations for Resource Management within the corridor. The recommendations include integrating better stormwater management methods (as identified in the Mallett’s Creek Restoration Plan) and ensuring future development is consistent with the adopted Natural Features regulations.

The Non-Motorized Plan recommends improved pedestrian connections between the buildings and the street. Bicycle lanes are available along South State Street in front of this location.

STAFF COMMENTS

Systems Planning (Engineering) – Adequate utilities exist to serve the site. No footing drain disconnects will be required. Petitioner must record an easement over the existing sanitary sewer main.

Planning – The proposed additions and renovations to the existing buildings will be a significant upgrade to the site and improve building appearance from South State Street. The addition of pedestrian connections to the buildings and added bicycle parking are consistent with intent of the Master Plan: Land Use Element and the South State Street Corridor Plan.

Planning staff has concerns regarding the amount of parking proposed to be constructed and the additional impervious surface, as well as the impact on the landmark trees. The parking and display area on the southern half of the site will be moved 32 feet closer to State Street than currently exists. While still remaining behind the required front setback (15 feet), a variance is required to provide tandem parking in this location. Staff does not support the granting of a variance for the expansion of this parking area.

Staff acknowledges that the area in the rear functions differently than a typical parking lot and in general would support reduced aisle widths and tandem parking, consistent with past ZBA approvals of similar requests for this site. However, staff encourages the petitioner to take additional steps to reduce impervious surface and/or provide alternative methods that would allow for an increase of car storage while reducing the expansion of paving.

Natural Resources (Landscaping) – Staff does not support the requested landscape modification or variances as proposed. The petitioner has not provided significant justification to satisfy the standards for impact to the landmark trees. Staff acknowledges that the car storage area in the rear of the site functions differently than a typical parking lot, however the intent of landscape islands is more than just aesthetic or pedestrian value. Landscape islands are intended to reduce the impervious surface, assist in storm water function and help reduce the heat island effect of large paved surfaces.

Malletts Creek Coordinating Committee (MCCC) – The MCCC met in early October to discuss the project and offered the following recommendations:

In the process of recognizing the Malletts Creek Restoration Plan, April 2000, on October 3, 2000 the City Planning Commission specifically resolved to minimize impervious area within the Malletts Creek watershed. This development proposal and the requested variance to exceed the parking maximums in Chapter 59 are in direct opposition of the recommendation of the Malletts Creek Restoration Plan and the City Planning Commission resolution. The Malletts Creek Coordinating Committee (MCCC) is not supportive of the request for a variance from the Landscape Ordinance (Chapter 62), requirement to have landscape islands every 15 spaces. Varying from this requirement will result in more impervious area, and thus more runoff will be contributed to Malletts Creek.

The Malletts Creek Coordinating Committee (MCCC) is not supportive of the request for a variance from the Landscape Ordinance (Chapter 62), requirement to have depressed bioswales within the interior landscaping of the parking lot. The purpose of this requirement is partially storm water quality driven. The variance could possibly be justified and/or mitigated if the petitioner provided a similar amount of storm water management throughout the site in the form of green roofs, sand filters, level spreaders, or other low impact development techniques.

Prepared by Matt Kowalski
Reviewed by Wendy Rampson

Attachments: Parcel/Zoning Map
Aerial Photo
Site Plan
Landscape Plan
Elevations
Landscape Modification Application

c: Petitioner: Robert Wanty
Washtenaw Engineering Company
3526 W Liberty Road, Suite 400
Ann Arbor, MI 48103

Owner: Car Ger MI Ann Arbor LLC
8270 Greensboro Dr. Suite 950
McLean, VA 22102

Systems Planning
File No. SP13-048

2575 S State St -Zoning Map-

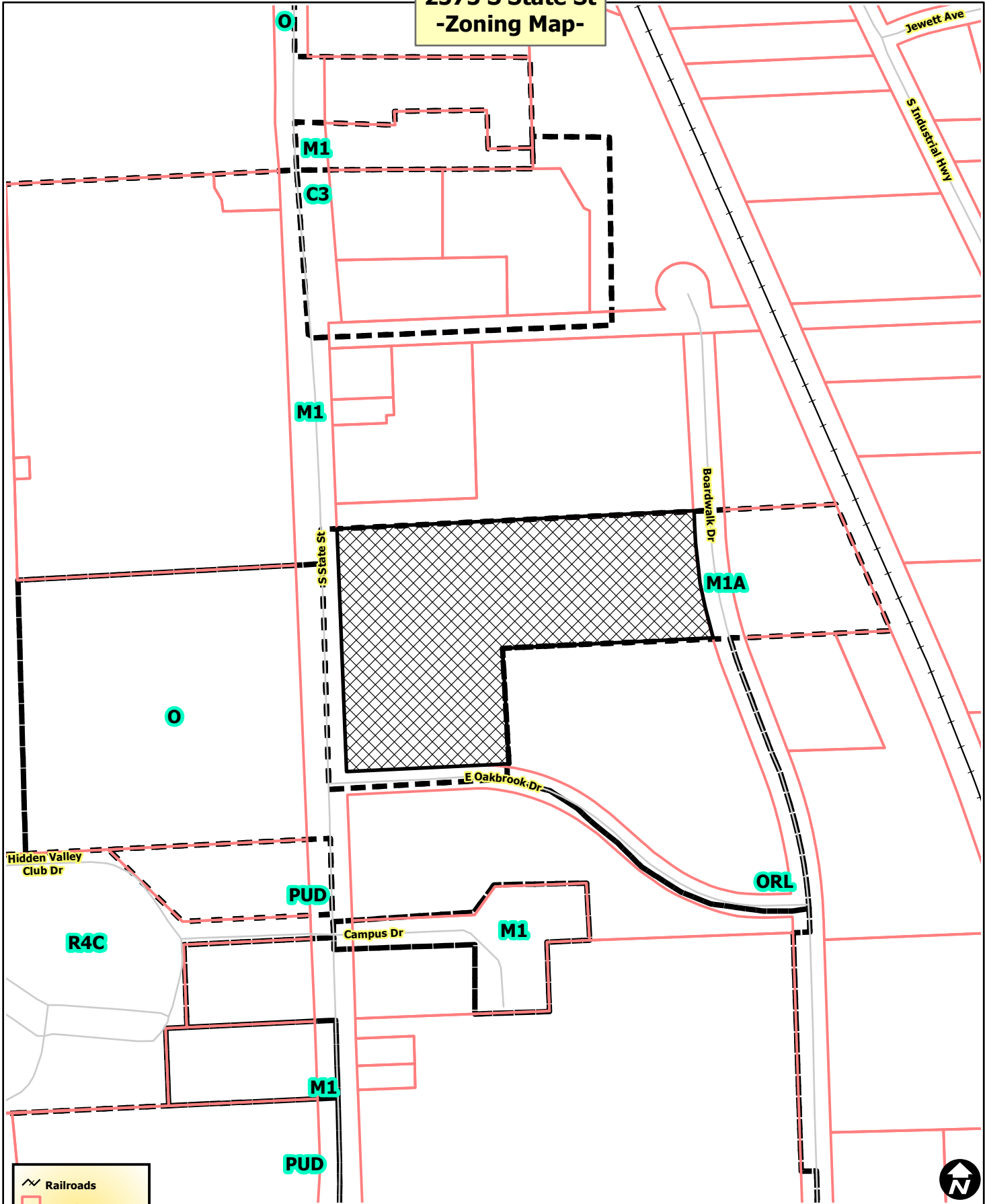

Legend

- Railroads
- Parcels
- Zoning**
- Township Islands
- Zoning Districts



City of Ann Arbor Map Disclaimer:
 No part of this product shall be reproduced or transmitted in any form or by any means, electronic or mechanical, for any purpose, without prior written permission from the City of Ann Arbor.
 This map complies with National Map Accuracy Standards for mapping at 1 Inch = 100 Feet. The City of Ann Arbor and its mapping contractors assume no legal representation for the content and/or inappropriate use of information on this map.
 Map Created: 8/16/2013

**2575 S State St
-Aerial Map-**

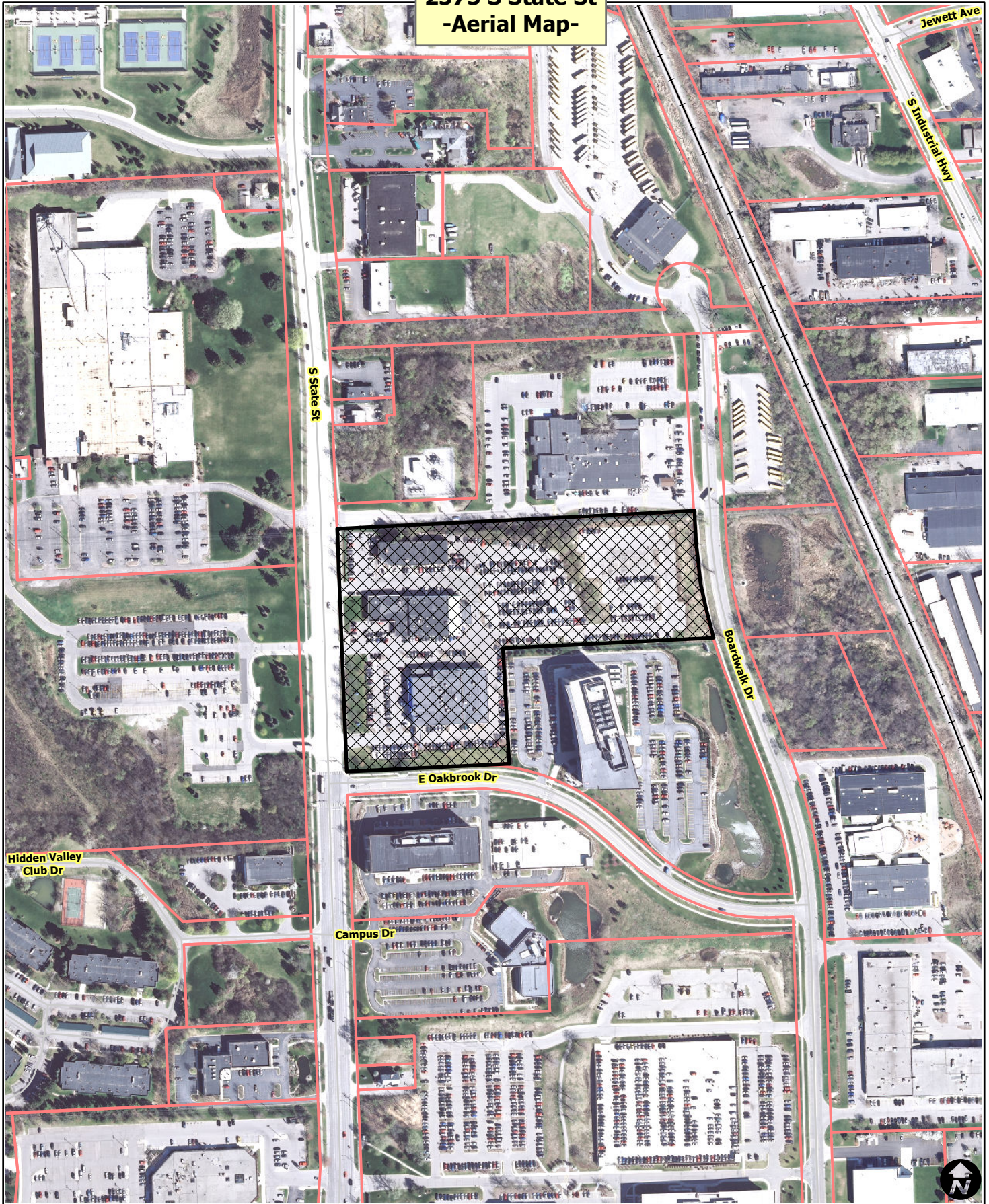

 Railroads
 Parcels



City of Ann Arbor Map Disclaimer:
 No part of this product shall be reproduced or transmitted in any form or by any means, electronic or mechanical, for any purpose, without prior written permission from the City of Ann Arbor.
 This map complies with National Map Accuracy Standards for mapping at 1 Inch = 100 Feet. The City of Ann Arbor and its mapping contractors assume no legal representation for the content and/or inappropriate use of information on this map.
 Map Created: 8/16/2013

2575 S State St -Aerial Map-



 Railroads
 Parcels



City of Ann Arbor Map Disclaimer:
No part of this product shall be reproduced or transmitted in any form or by any means, electronic or mechanical, for any purpose, without prior written permission from the City of Ann Arbor.
This map complies with National Map Accuracy Standards for mapping at 1 Inch = 100 Feet. The City of Ann Arbor and its mapping contractors assume no legal representation for the content and/or inappropriate use of information on this map.
Map Created: 8/16/2013

PREVIOUS VARIANCES:
 1. DECEMBER 20, 2000 - GRANTED A VARIANCE FROM THE OFF-STREET PARKING ORDINANCE TO ALLOW THE EAST PARKING AREA (AUTO STORAGE) TO HAVE (1) STACKED PARKING, (2) 20-FT. AISLE-WAYS AND (3) 8-FT. X 16-FT. SPACES FOR THE STORAGE OF AUTOMOBILES. (1) IN THE CASE OF STACKED PARKING, A VARIANCE TO ALLOW 114 STACKED SPACES. (2) IN THE CASE OF 20-FT. AISLE-WAYS, A VARIANCE OF 4-FT. FROM THE 24-FT. AISLE-WAY TO ALLOW 20-FT. AISLE-WAYS IN THIS STORAGE AREA. (3) IN THE CASE OF SPACE SIZE, A VARIANCE OF 28% FROM THE 30% PERMITTED SMALL CAR SPACES TO ALLOW 58% OF PARKING TO BE SMALL CAR, MANY WITHIN THIS STORAGE AREA.
 2. AUGUST 27, 2003 - GRANTED A VARIANCE OF 1 FT. FROM THE 9 FT. PARKING STALL WIDTH, 2 FT. FROM THE PARKING AISLE WIDTH AND TO ALLOW STACKED PARKING PER SITE PLAN FOR THIS AUTOMOBILE SALES STORAGE AREA.
 3. MAY 25, 2005 - GRANTED A VARIANCE FROM THE REQUIRED FRONT YARD SETBACK TO ALLOW STACKED PARKING AT A LOCATION WHERE IT REQUIRES A VARIANCE OF 20.2 FEET FROM THE OAKBROOK SETBACK WHERE 52.7 FEET WOULD BE REQUIRED. THE VARIANCE IS GRANTED FOR 13 PARKING SPACES IN THE FRONT SETBACK THAT DID PREVIOUSLY EXIST. POROUS PAVERS WILL BE USED IN THE ENTIRE FRONT STACKED AREA.

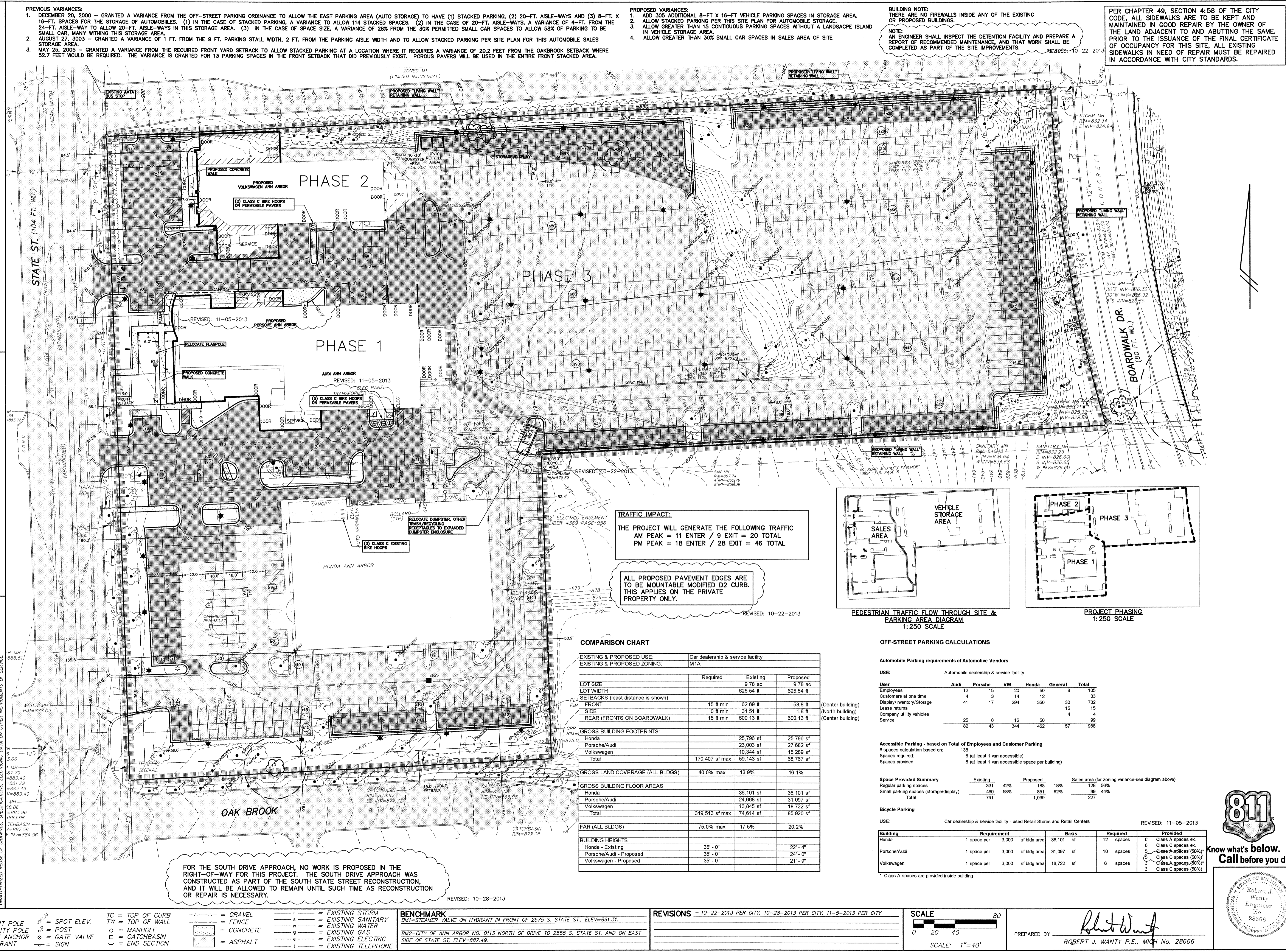

- PROPOSED VARIANCES:
 1. ADD 305 ADDITIONAL 8-FT X 16-FT VEHICLE PARKING SPACES IN STORAGE AREA.
 2. ALLOW STACKED PARKING PER THIS SITE PLAN FOR AUTOMOBILE STORAGE.
 3. ALLOW GREATER THAN 15 CONTIGUOUS PARKING SPACES WITHOUT A LANDSCAPE ISLAND IN VEHICLE STORAGE AREA.
 4. ALLOW GREATER THAN 30% SMALL CAR SPACES IN SALES AREA OF SITE

BUILDING NOTE:
 THERE ARE NO FIREWALLS INSIDE ANY OF THE EXISTING OR PROPOSED BUILDINGS.
 NOTE:
 AN ENGINEER SHALL INSPECT THE DETENTION FACILITY AND PREPARE A REPORT OF RECOMMENDED MAINTENANCE, AND THAT WORK SHALL BE COMPLETED AS PART OF THE SITE IMPROVEMENTS.

PER CHAPTER 49, SECTION 4-5B OF THE CITY CODE, ALL SIDEWALKS ARE TO BE KEPT AND MAINTAINED IN GOOD REPAIR BY THE OWNER OF THE LAND ADJACENT TO AND ABUTTING THE SAME. PRIOR TO THE ISSUANCE OF THE FINAL CERTIFICATE OF OCCUPANCY FOR THIS SITE, ALL EXISTING SIDEWALKS IN NEED OF REPAIR MUST BE REPAIRED IN ACCORDANCE WITH CITY STANDARDS.

TRAFFIC IMPACT:
 THE PROJECT WILL GENERATE THE FOLLOWING TRAFFIC
 AM PEAK = 11 ENTER / 9 EXIT = 20 TOTAL
 PM PEAK = 18 ENTER / 28 EXIT = 46 TOTAL

ALL PROPOSED PAVEMENT EDGES ARE TO BE MOUNTABLE MODIFIED D2 CURB. THIS APPLIES TO THE PRIVATE PROPERTY ONLY.

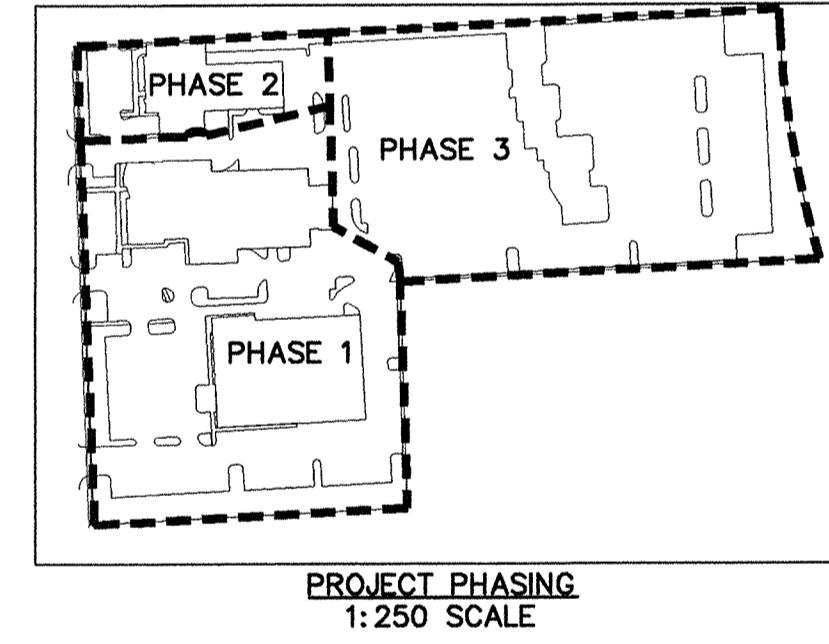
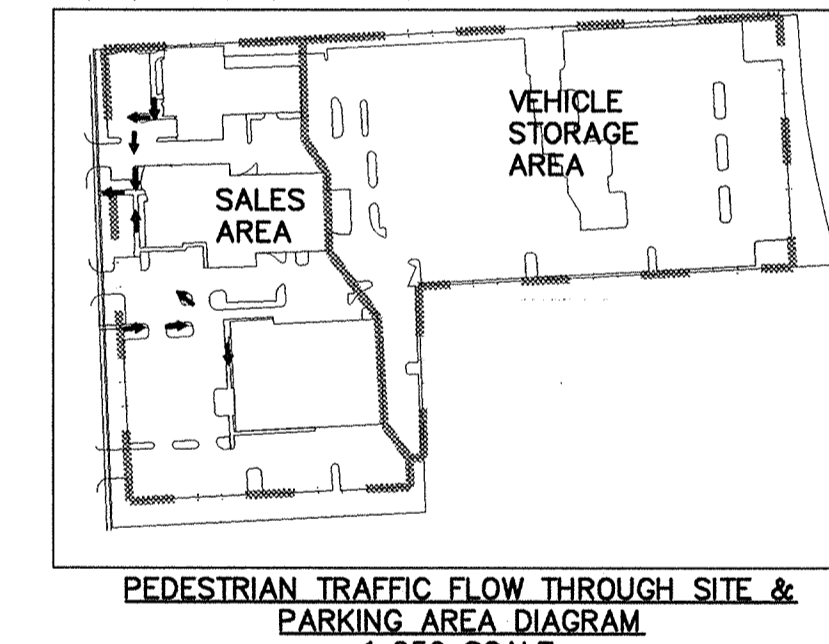

COMPARISON CHART

EXISTING & PROPOSED USE:	Car dealership & service facility		
	Required	Existing	Proposed
LOT SIZE	9.78 ac	9.78 ac	9.78 ac
LOT WIDTH	625.54 ft	625.54 ft	625.54 ft
SETBACKS (least distance is shown)			
FRONT	15 ft min	62.69 ft	53.8 ft
SIDE	0 ft min	31.51 ft	1.8 ft
REAR (FRONTS ON BOARDWALK)	15 ft min	600.13 ft	600.13 ft
GROSS BUILDING FOOTPRINTS:			
Honda		25,796 sf	25,796 sf
Porsche/Audi		23,003 sf	27,682 sf
Volkswagen		10,344 sf	15,289 sf
Total	170,407 sf max	59,143 sf	68,767 sf
GROSS LAND COVERAGE (ALL BLDGS)	40.0% max	13.9%	16.1%
GROSS BUILDING FLOOR AREAS:			
Honda		36,101 sf	36,101 sf
Porsche/Audi		24,668 sf	31,097 sf
Volkswagen		13,845 sf	18,722 sf
Total	319,513 sf max	74,614 sf	85,920 sf
FAR (ALL BLDGS)	75.0% max	17.8%	20.2%
BUILDING HEIGHTS			
Honda - Existing	35' - 0"		22' - 4"
Porsche/Audi - Proposed	35' - 0"		24' - 0"
Volkswagen - Proposed	35' - 0"		21' - 0"

OFF-STREET PARKING CALCULATIONS

Automobile Parking requirements of Automotive Vendors

USE: Automobile dealership & service facility

User	Audi	Porsche	VW	Honda	General	Total
Employees	12	15	20	50	8	105
Customers at one time	4	3	14	12	3	33
Display/Inventory/Storage	41	17	294	350	30	732
Lease return					15	15
Company utility vehicles					4	4
Service	25	8	16	50		99
	82	43	344	462	57	988

Accessible Parking - based on Total of Employees and Customer Parking

spaces calculation based on:

Spaces required: 5 (at least 1 van accessible)
 Spaces provided: 6 (at least 1 van accessible space per building)

Space Provided Summary

	Existing	Proposed	Required	Percent
Regular parking spaces	331	42%	188	128 59%
Small parking spaces (storage/display)	460	58%	851	62% 99 44%
Total	791	1,039		

Bicycle Parking

Building	Required	Provided
Honda	1 space per 5,000 sf bldg area	36,101 sf
Porsche/Audi	1 space per 3,000 sf bldg area	31,097 sf
Volkswagen	1 space per 3,000 sf bldg area	18,722 sf

FOR THE SOUTH DRIVE APPROACH, NO WORK IS PROPOSED IN THE RIGHT-OF-WAY FOR THIS PROJECT. THE SOUTH DRIVE APPROACH WAS CONSTRUCTED AS PART OF THE SOUTH STATE STREET RECONSTRUCTION, AND IT WILL BE ALLOWED TO REMAIN UNTIL SUCH TIME AS RECONSTRUCTION OR REPAIR IS NECESSARY.

- LEGEND
- = LIGHT POLE
 - = UTILITY POLE
 - = GUY ANCHOR
 - = HYDRANT
 - = SPOT ELEV.
 - = POST
 - = GATE VALVE
 - = SIGN
 - = GRAVEL
 - = FENCE
 - = CONCRETE
 - = ASPHALT
 - = EXISTING STORM
 - = EXISTING SANITARY
 - = EXISTING WATER
 - = EXISTING GAS
 - = EXISTING ELECTRIC
 - = EXISTING TELEPHONE

- BENCHMARK
- BM1=STEAMER VALVE ON HYDRANT IN FRONT OF 2575 S. STATE ST., ELEV=891.31.
- BM2=CITY OF ANN ARBOR NO. 0113 NORTH OF DRIVE TO 2555 S. STATE ST. AND ON EAST SIDE OF STATE ST., ELEV=887.49.

REVISIONS - 10-22-2013 PER CITY, 10-28-2013 PER CITY, 11-5-2013 PER CITY

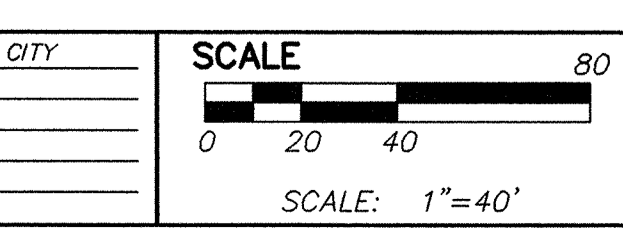

PREPARED BY: Robert J. Wanty, P.E., MICH No. 28666

CIVIL ENGINEERS
 PLANNERS & SURVEYORS
 LANDSCAPE ARCHITECTS
 3528 W. LIBERTY RD.
 SUITE 400
 ANN ARBOR, MI 48103
 TEL: 734-761-8800
 FAX: 734-761-4899
 WWW.WASHTENAWENGINEERING.COM

ARCHITECTURAL ALLIANCE
 165 NORTH FIFTH ST
 COLUMBUS, OH 43215
 TEL: 614-459-0000
 WWW.CRALL.COM

CLIENT

SHEET

PROJECT

SECTION 4 TOWN 3 SOUTH RANGE 6 EAST
 CITY OF ANN ARBOR
 WASHTEWATON COUNTY, MICHIGAN
 JOB NO. 31667
 DWG NO. 667-5-518
 FIELD BOOK 556, 649
 FILE NO. 10027

GERMAIN OF ANN ARBOR CAMPUS IMPROVEMENTS

811 Know what's below. Call before you dig.

Robert J. Wanty
 Engineer No. 28666

5 SHEET

SITE PLAN

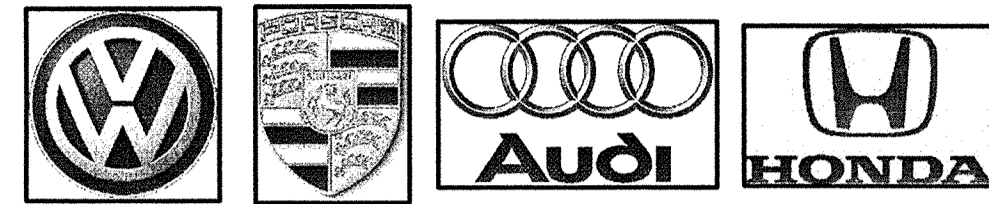

GERMAIN OF ANN ARBOR CAMPUS IMPROVEMENTS

A PART OF THE SOUTHWEST 1/4 SECTION 4, T2S, R6E,
CITY OF ANN ARBOR, WASHTENAW COUNTY, MICHIGAN

COMMUNITY IMPACT

- THE PROPOSED IMPROVEMENTS TO THE SITE WILL HAVE MINIMAL IMPACT ON THE NEIGHBORS AND OVERALL COMMUNITY.
- AS IT IS NOT A HOUSING PROJECT, THERE WILL BE NO IMPACT ON AREA SCHOOLS.
 - THE ENTRIES ARE NOT CHANGING SIGNIFICANTLY AND THERE IS PROJECTED TO BE 20 ADDITIONAL AM PEAK TRIPS AND 46 ADDITIONAL PM PEAK TRIPS AS A RESULT OF THIS PROJECT. INCREASE IN TRAFFIC (VEHICLE STORAGE AREAS HAVE NO EFFECT ON TRAFFIC GENERATION).
 - THE ADDITIONAL VEHICLE STORAGE AREAS WILL BE SCREENED BY LANDSCAPING.
 - THE EXISTING STORM WATER DETENTION POND HAS SUFFICIENT CAPACITY TO HANDLE THE PROPOSED NEW IMPERVIOUS SURFACE WITH NO CHANGES SO RUNOFF WILL NOT NEGATIVELY IMPACT THE NEIGHBORS OR OUTLET.
 - THE BUILDING APPEARANCE AND LANDSCAPING ALONG STATE STREET WILL BE IMPROVED TO BENEFIT PASSERSBY.
 - NEW BENCHES WILL BE LOCATED ALONG STATE STREET FOR PEDESTRIAN USE.
 - THERE ARE NO HISTORIC FEATURES ON THE PROPERTY SO THERE WILL BE NO NEGATIVE ARCHAEOLOGICAL IMPACTS FROM THE DEVELOPMENT.
 - THE ONLY NEGATIVE IMPACTS ON NATURAL FEATURES WILL BE TWO LANDMARK BOXELDER TREES THAT WILL BE REMOVED, AND SOME MAN-CREATED STEEP SLOPES WILL BE IMPACTED BY EXPANSION OF THE PARKING AREAS.

CONSTRUCTION NOTES

- ALL WORK ON THIS SITE WILL BE IN ACCORDANCE WITH ALL APPLICABLE CURRENT STANDARDS & SPECIFICATIONS OF THE CITY OF ANN ARBOR EXCEPT AS HEREIN MODIFIED.
- IT IS ESSENTIAL THAT THE CONTRACTOR FAMILIARIZE HIMSELF WITH THE SITE PRIOR TO SUBMITTING PROPOSAL.
- IT SHALL BE THE CONTRACTORS RESPONSIBILITY TO VERIFY AND/OR OBTAIN ANY INFORMATION NECESSARY REGARDING THE PRESENCE OF UNDERGROUND UTILITIES WHICH MIGHT AFFECT THIS JOB.
- CONTRACTOR SHALL BE RESPONSIBLE FOR DAMAGE TO AND THE REPAIR OF ANY EXISTING UTILITY LINE IN THE CONSTRUCTION ZONE.
- AT LEAST 72 HOURS PRIOR TO ANY EXCAVATION, THE CONTRACTOR SHALL CALL "MISS DIG" (1-800-482-7171) FOR UTILITY LOCATIONS.
- LOCATION OF EXISTING UTILITIES WERE TAKEN FROM EXISTING PLANS. LOCATIONS WERE FIELD VERIFIED WHERE POSSIBLE.
- CONTRACTOR MUST OBTAIN AN EROSION CONTROL PERMIT FROM THE CITY OF ANN ARBOR PRIOR TO BEGINNING EARTH MOVING. CONTRACTOR WILL BE RESPONSIBLE FOR OBTAINING ALL NECESSARY PERMITS PRIOR TO BEGINNING CONSTRUCTION.
- CONTRACTOR SHALL BE RESPONSIBLE FOR INSTALLATION, MAINTENANCE AND REMOVAL OF ALL TEMPORARY EROSION CONTROL MEASURES PER THIS APPROVED PLAN.
- ANY CONDITIONS EXISTING ON THE SITE THAT ARE NOT CONSISTENT WITH THE PLANS OR SOIL EROSION SEDIMENTATION PERMIT WILL RESULT IN A STOP WORK ORDER AND REVOCATION OF THE SOIL EROSION SEDIMENTATION CONTROL PERMIT.
- ALL FILL MATERIAL MUST BE PLACED IN LIFTS NOT EXCEEDING 12 INCHES AND COMPACTED TO 95% OF THE MAXIMUM UNIT WEIGHT.
- THE CONTRACTOR WILL BE REQUIRED TO PROOF ROLL (WITH A HEAVY RUBBER Tired VEHICLE) ALL FILL AREAS PRIOR TO PLACING ADDITIONAL FILL AND ALL CUT AREAS UPON COMPLETION OF THE CUT AND PRIOR TO PLACING SUBBASE MATERIAL. IF THE PROOF ROLLING INDICATES UNSTABLE AREAS THE UNSTABLE MATERIAL MUST BE REMOVED AND REPLACED WITH MATERIAL MATCHING THE ADJACENT SOILS TO THE ELEVATION OF THE SUB-GRADE.
- THE FINISHED SUBGRADE MUST BE GRADED WITH A TOLERANCE OF ± 0.1 FEET OF DESIGN GRADE COMPACTED TO NOT LESS THAN 95% OF THE MAXIMUM UNIT WEIGHT TO A DEPTH OF 9 INCHES AND APPROVED BY THE OWNERS REPRESENTATIVE PRIOR TO PLACEMENT OF THE SUBBASE.
- THE FINISHED SUBBASE MUST BE GRADED WITH A TOLERANCE OF ± 3/4 INCH OF THE DESIGN GRADE AND APPROVED BY THE OWNERS REPRESENTATIVE PRIOR TO PLACEMENT OF THE AGGREGATE BASE. FINE GRADING PRIOR TO THE PLACEMENT OF THE AGGREGATE BASE MATERIAL SHALL BE INCLUDED IN THE COST OF FURNISHING AND PLACING THE SUBBASE.
- THE WORK OF CONSTRUCTING ON AGGREGATE BASE COURSE SHALL CONFORM TO MDT SPECIFICATION 3.01 EXCEPT THAT FINE GRADING PRIOR TO PLACEMENT OF OF THE BITUMINOUS SURFACING SHALL BE INCLUDED IN THE COST OF FURNISHING AND PLACING THE AGGREGATE BASE.
- ALL PAVEMENT GRADES SHOWN REPRESENT TOP OF PAVEMENT AND EDGE OF METAL UNLESS OTHERWISE NOTED.
- ALL CONSTRUCTION TRAFFIC CONTROL SHALL BE SIGNED PER THE MANUAL OF UNIFORM TRAFFIC CONTROL DEVICES. CONTRACTOR SHALL MAINTAIN ACCESS FOR EMERGENCY VEHICLES AT ALL TIMES.

OWNER:
CAR GER MI ANN ARB L.L.C.
8270 GREENSBORO DR. #950
McLEAN, VA 22102-4909

FOR:

CAR GER MI ANN ARB L.L.C. (OWNER)
8270 GREENSBORO DR. #950
McLEAN, VA 22102-4909

SEPTEMBER, 2013

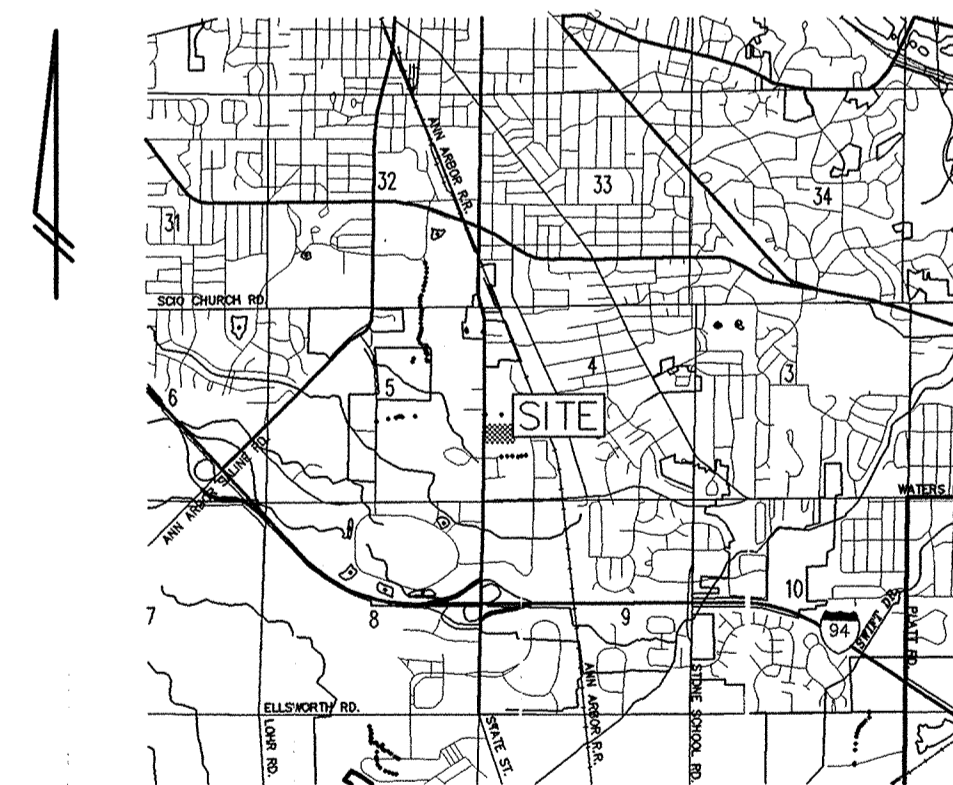

VICINITY MAP
NOT TO SCALE

ARCHITECT



GENERAL CONTRACTOR



CIVIL ENGINEER / PETITIONER

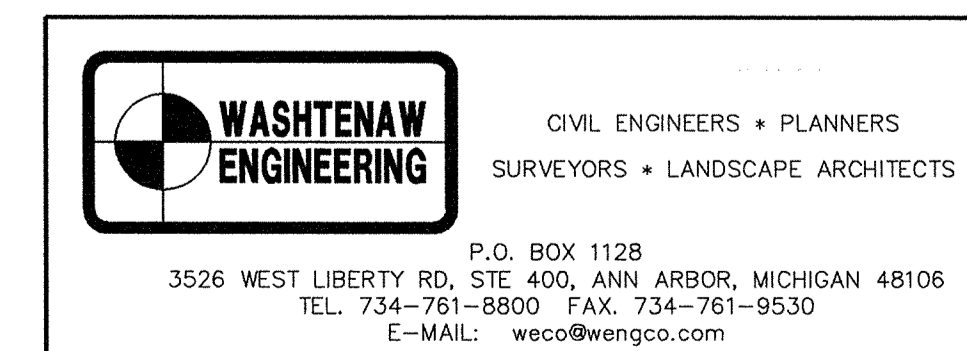

STATEMENT OF INTEREST IN THE LAND

ALL LAND ENCOMPASSED IN THE SCOPE OF THIS SUBMITTAL IS WITHIN THE PROPERTY LINES OF THE CURRENT SITE AND WILL REMAIN UNDER THE SAME OWNERSHIP. THE PROPOSED BUILDING REMODELS AND INCREASED PARKING ON SITE WILL FURTHER STREAMLINE ALL BUSINESS PROCESSES RESULTING IN AN ENHANCED CUSTOMER EXPERIENCE THAT WILL GENERATE MORE REVENUE FOR THE BUSINESS AND THE CITY OF ANN ARBOR.

DEVELOPMENT PROGRAM

THE SITE IS AN EXISTING AUTOMOBILE SALES AND SERVICE DEALERSHIP, SERVING FOUR DIFFERENT AUTOMAKERS - AUDI, HONDA, PORSCHE AND VOLKSWAGEN. THIS PROJECT PROPOSES THE EXPANSION AND REMODELING OF TWO OF THE THREE BUILDINGS ON THE SITE (6,429 SF EXPANSION OF THE PORSCHE/AUDI BUILDING AND 4,877 SF EXPANSION OF THE VOLKSWAGEN BUILDING). IT ALSO INCLUDES THE EXPANSION OF THE CUSTOMER AND EMPLOYEE PARKING AND AUTOMOBILE INVENTORY EXTERIOR DISPLAY AND STORAGE ON THE SITE. THESE ARE NEEDED TO MAINTAIN AND UPGRADE THE QUALITY OF THE SITE'S FACILITIES, ENHANCE THE CUSTOMER EXPERIENCE, AND MEET THE REQUIREMENTS OF THE AUTOMOBILE MANUFACTURERS REPRESENTED BY GERMAIN.

THE EXPANSIONS WILL NOT REQUIRE ANY MODIFICATION TO THE STORM WATER DETENTION FACILITIES OR THE WETLAND MITIGATION AREA ON THE EAST SIDE OF BOARDWALK SO NO CHANGES OF ANY KIND ARE PROPOSED IN THAT AREA.

THE PROJECT WILL BE COMPLETED IN THREE PHASES. A DIAGRAM OF THOSE PHASES CAN BE FOUND ON SHEET #5 (SITE PLAN).

LANDSCAPING ALONG STATE STREET WILL BE SIGNIFICANTLY ENHANCED TO PROVIDE AN ATTRACTIVE VIEW FOR PASSERSBY ON STATE STREET AND WILL ALSO PROVIDE BENCHES ALONG THE STATE STREET SIDEWALK FOR PEDESTRIAN USE. DUE TO DIFFICULT SLOPE AND SOIL CONDITIONS IN THE LARGE INTERIOR ISLAND, A REQUEST FOR MODIFICATION FROM THE LANDSCAPE REQUIREMENTS WILL BE PART OF THIS APPLICATION FOR SOME OF THE REQUIRED INTERIOR LANDSCAPE TREES THAT CAN'T BE PLANTED.

IT IS ANTICIPATED THAT THE PROJECT WILL COST APPROXIMATELY \$5,475,000.

SHEET TITLE

SHEET NO.

COVER SHEET	1
TOPOGRAPHICAL SURVEY	2
NATURAL FEATURES ANALYSIS	3
REMOVAL PLAN	4
SITE PLAN	5
GRADING & SOIL EROSION CONTROL PLAN	6
SOIL EROSION CONTROL NOTES AND DETAILS	7
UTILITY PLAN	8
DRAINAGE AREA PLAN AND CALCULATIONS	9
LANDSCAPE PLAN	10
DETAILS	11
ARCHITECTURAL PLANS	
AERIAL VIEW	A1.01
EXTERIOR ELEVATIONS	A1.02 & A1.03
FLOOR PLANS	A2.02 & A2.03
PHOTOMETRIC PLAN	SL1.01 & SL1.02

NOTE:

PRE-APPLICATION MEETING WITH WENDY RAMPSON - 9/27/13

PREPARED BY

ROBERT J. WANTY P.E., MICH. No. 28666

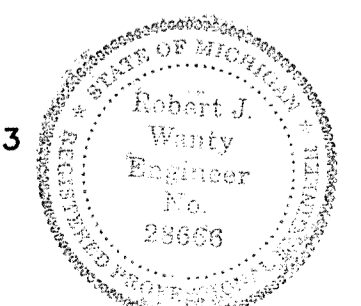

REVISED: 11-05-13
REVISED: 10-22-13
ORIGINAL: 9-30-13

GERMAIN OF ANN ARBOR CAMPUS IMPROVEMENTS

THE UNDERGROUND UTILITIES SHOWN HAVE BEEN LOCATED FROM FIELD SURVEY INFORMATION AND EXISTING RECORDS. THE SURVEYOR MAKES NO WARRANTY AS TO THE ACCURACY OF THE INFORMATION PROVIDED. THE SURVEYOR HAS NOT PHYSICALLY LOCATED THE UNDERGROUND UTILITIES. THE SURVEYOR FURTHER DOES NOT WARRANT THAT THE UNDERGROUND UTILITIES SHOWN ARE IN THE EXACT LOCATION INDICATED, ALTHOUGH THE SURVEYOR HAS USED REASONABLE CARE TO LOCATE THEM AS ACCURATELY AS POSSIBLE FROM THE INFORMATION AVAILABLE. THE SURVEYOR HAS NOT PHYSICALLY LOCATED THE UNDERGROUND UTILITIES.

THE OWNER SHALL NOT USE OR AUTHORIZE ANY OTHER PERSON TO USE THE DRAWINGS, SPECIFICATIONS, ELECTRONIC DATA AND ANY OTHER INFORMATION CONTAINED HEREIN FOR ANY OTHER PROJECT WITHOUT THE WRITTEN CONSENT OF WASHTENAW ENGINEERING COMPANY, INC. NO REPRODUCTION SHALL BE MADE WITHOUT PRIOR WRITTEN CONSENT OF WASHTENAW ENGINEERING COMPANY, INC.

THE OWNER SHALL NOT USE OR AUTHORIZE ANY OTHER PERSON TO USE THE DRAWINGS, SPECIFICATIONS, ELECTRONIC DATA AND ANY OTHER INFORMATION CONTAINED HEREIN FOR ANY OTHER PROJECT WITHOUT THE WRITTEN CONSENT OF WASHTENAW ENGINEERING COMPANY, INC. NO REPRODUCTION SHALL BE MADE WITHOUT PRIOR WRITTEN CONSENT OF WASHTENAW ENGINEERING COMPANY, INC.

WASHTENAW COUNTY SOIL SURVEY CLASSIFICATION
MdA - MATHERTON SANDY LOAM, 0 TO 4 PCT SLOPES
MoB - MORLEY LOAM, 2 TO 6 PCT SLOPES
MoC - MORLEY LOAM, 6 TO 12 PCT SLOPES
Sb - SEWABO LOAM
 - SOILS BOUNDARY
 SOILS ARE BASED ON USDA SOIL SURVEY OF WASHTENAW COUNTY.

= LANDMARK TREE WITH CRITICAL ROOT ZONE

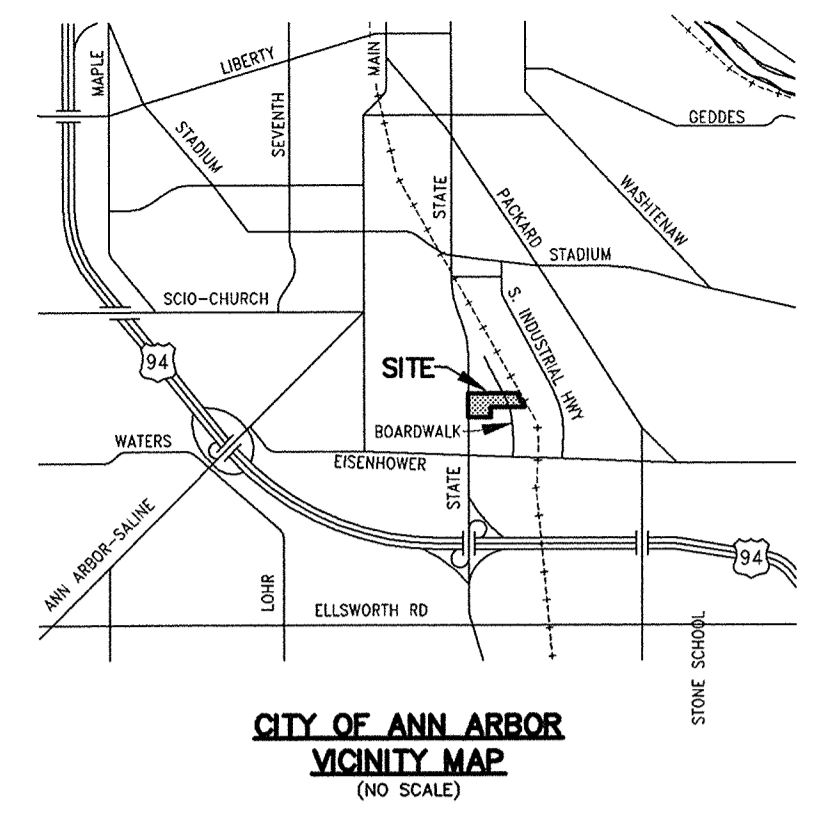

EXISTING TREES

West Parcel

Tree #	LAND-MARK	Scientific name	Common name	Size (in dbh)
12	N	Populus deltoides	Cottonwood	6
13	N	Rhamnus cathartica	Common buckthorn	6,5,4,3
14	N	Acer negundo	Boxelder	12
15	N	Juniperus virginiana	Eastern redcedar	6
16	N	Pyrus sp.	Pear	6
21	N	Populus deltoides	Cottonwood	6
22	N	Populus deltoides	Cottonwood	8,6
23	N	Populus deltoides	Cottonwood	7
24	N	Acer negundo	Boxelder	12,8
25	N	Acer negundo	Boxelder	6
26	N	Juniperus virginiana	Eastern redcedar	6
27	N	Ulmus americana	American elm	12,6
28	N	Prunus velutina	Black cherry	6
29	N	Acer negundo	Boxelder	8
30	N	Acer negundo	Boxelder	7
31	N	Rhamnus cathartica	Common buckthorn	6,4,3
32	N	Rhamnus cathartica	Common buckthorn	6
33	N	Acer negundo	Boxelder	8
34	N	Acer negundo	Boxelder	12
35	N	Acer negundo	Boxelder	5
36	N	Morus alba	White mulberry	12
46	N	Acer negundo	Boxelder	8
66	N	Acer negundo	Boxelder	6
68	N	Acer negundo	Boxelder	6
69	N	Acer negundo	Boxelder	14
70	N	Acer negundo	Boxelder	12
71	N	Acer negundo	Boxelder	12
72	Y	Acer negundo	Boxelder	12,12
73	N	Acer negundo	Boxelder	6
75	N	Acer saccharinum	Silver Maple	10,5,5
76	Y	Acer negundo	Boxelder	14,14
77	N	Acer negundo	Boxelder	8
79	N	Acer negundo	Boxelder	10
80	N	Acer negundo	Boxelder	12
87	N	Populus deltoides	Cottonwood	15
88	N	Populus deltoides	Cottonwood	14
90	N	Robinia pseudoacacia	Black locust	10
106	N	Robinia pseudoacacia	Black locust	6
132	N	Populus deltoides	Cottonwood	10
133	N	Populus deltoides	Cottonwood	10,10
134	N	Salix amygdaloides	Peachleaf willow	9
138	N	Populus deltoides	Cottonwood	18
146	N	Populus deltoides	Cottonwood	17
147	N	Acer negundo	Boxelder	12
148	N	Populus deltoides	Cottonwood	18
149	N	Populus deltoides	Cottonwood	12
150	Y	Acer negundo	Boxelder	16
151	N	Populus deltoides	Cottonwood	4,7
174	N	Populus deltoides	Cottonwood	14,14

Tree #	LAND-MARK	Scientific name	Common name	Size (in dbh)
175	Y	Acer negundo	Boxelder	6,10,12
176	N	Acer negundo	Boxelder	8
243	N	Ailanthus altissima	Tree-of-Heaven	12,12
244	N	Ailanthus altissima	Tree-of-Heaven	18
245	N	Acer negundo	Boxelder	7
246	N	Acer negundo	Boxelder	11
247	N	Acer negundo	Boxelder	7
248	N	Morus alba	White mulberry	8,12,12
249	N	Picea pungens	Colorado blue spruce	12
250	N	Picea pungens	Colorado blue spruce	12
251	N	Picea pungens	Colorado blue spruce	12
252	N	Picea pungens	Colorado blue spruce	13
253	N	Acer negundo	Boxelder	10
254	N	Picea pungens	Colorado blue spruce	11
255	N	Tilia cordata	Littleleaf linden	12
256	N	Tilia cordata	Littleleaf linden	12
257	N	Tilia cordata	Littleleaf linden	12
258	N	Tilia cordata	Littleleaf linden	4
259	N	Tilia cordata	Littleleaf linden	7
260	N	Tilia cordata	Littleleaf linden	12
261	N	Tilia cordata	Littleleaf linden	6
262	N	Tilia cordata	Littleleaf linden	8
263	N	Tilia cordata	Littleleaf linden	12
264	N	Tilia cordata	Littleleaf linden	10
265	N	Tilia cordata	Littleleaf linden	12
266	N	Tilia cordata	Littleleaf linden	10
267	N	Tilia cordata	Littleleaf linden	10
268	N	Tilia cordata	Littleleaf linden	10
269	N	Tilia cordata	Littleleaf linden	6
270	N	Tilia cordata	Littleleaf linden	10
273	Y	Gleditsia triacanthos	Honeylocust	24
300	N	Acer negundo	Boxelder	12
301	N	Acer negundo	Boxelder	8
302	N	Acer negundo	Boxelder	13
303	N	Acer negundo	Boxelder	8,5,5
304	N	Acer negundo	Boxelder	7
305	N	Acer negundo	Boxelder	11
306	N	Acer negundo	Boxelder	8,5,5
307	N	Juglans nigra	Black walnut	12
308	N	Ailanthus altissima	Tree-of-Heaven	7
309	N	Acer negundo	Boxelder	10
310	Y	Acer negundo	Boxelder	16,10
311	Y	Acer negundo	Boxelder	16,8
312	N	Acer negundo	Boxelder	7
313	N	Acer negundo	Boxelder	7
314	N	Acer negundo	Boxelder	8
315	N	Acer negundo	Boxelder	6
316	N	Acer negundo	Boxelder	12

PARCEL I
 Commencing at the Southwest corner of Section 4, T3S, R6E, City of Ann Arbor, Washtenaw County, Michigan; thence N01°53'00"W 250.00 feet along the West line of said Section; thence N87°09'00"E 51.25 feet to a point on the East line of State Street; thence along said East line N02°03'20"W 1261.81 feet to the POINT OF BEGINNING; thence continuing along said East line N02°03'20"W 625.54 feet; thence N87°05'00"E 913.86 feet to a point on the Westerly line of Boardwalk Drive; thence along said Westerly line in the following two courses: S02°59'30"E 26.05 feet and Southerly 305.38 feet along the arc of a 1290.90 foot radius circular curve to the left through a central angle of 13°33'15" having a chord that bears S09°46'05"E 304.67 feet; thence S87°01'00"W 546.42 feet; thence S01°53'00"E 295.86 feet; thence S87°01'00"W 407.90 feet to the Point of Beginning. Being a part of the Southwest 1/4 of Section 4, T3S, R6E, City of Ann Arbor, Washtenaw County, Michigan and containing 9.78 acres of land, more or less. Being subject to easements and restrictions of record, if any.

PARCEL II
 Commencing at the Southwest corner of Section 4, T3S, R6E, City of Ann Arbor, Washtenaw County, Michigan; thence N01°53'00"W 250.00 feet along the West line of said Section; thence N87°09'00"E 51.25 feet to a point on the East line of State Street; thence along said East line N02°03'20"W 1261.81 feet; thence N87°01'00"E 407.90 feet; thence N01°53'00"W 295.86 feet; thence N87°01'00"E 628.87 feet to a point on the Easterly line of Boardwalk Drive, said point being the POINT OF BEGINNING; thence along said Easterly line in the following two courses: Northerly 305.79 feet along the arc of a 1210.90 foot radius circular curve to the right through a central angle of 14°28'09" having a chord that bears N10°13'32"W 304.98 feet and N02°59'30"W 26.74 feet; thence N87°05'00"E 290.46 feet to a point on the Westerly line of the Ann Arbor Railroad; thence along said Westerly line S24°07'30"E 352.69 feet; thence S87°01'00"W 379.22 feet to the Point of Beginning. Being a part of the Southwest 1/4 of Section 4, T3S, R6E, City of Ann Arbor, Washtenaw County, Michigan and containing 2.59 acres of land, more or less. Being subject to easements and restrictions of record, if any.

NOTE:
 SINCE NO WORK WILL BE DONE ON EAST PARCEL (PARCEL II), TREE INVENTORY WAS NOT COMPLETED AND IS NOT SHOWN HERE.

NOTE:
 "EXISTING" CONTOURS IN AREAS OUTSIDE OF NEW CONSTRUCTION FROM APPROVED PLANS, NOT FIELD VERIFIED.

NOTE:
 EASEMENT LOCATION, LIBER AND PAGE INFORMATION FROM ALTA SURVEY BY MILLMAN SURVEYING, INC. 8-29-2012

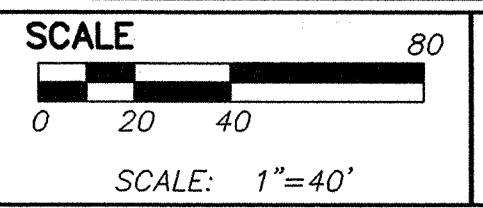

PREPARED BY *Thomas L. Sutherland*
 THOMAS L. SUTHERLAND P.S., MICH No. 24620

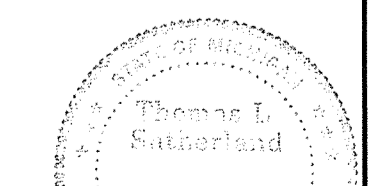
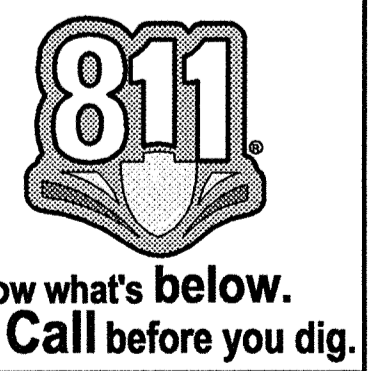

- LEGEND**
- = LIGHT POLE
 - = UTILITY POLE
 - = GUY ANCHOR
 - = HYDRANT
 - = SPOT ELEV.
 - = POST
 - = GATE VALVE
 - = SIGN
 - = TOP OF CURB
 - = TOP OF WALL
 - = MANHOLE
 - = CATCHBASIN
 - = END SECTION
 - = GRAVEL
 - = FENCE
 - = CONCRETE
 - = ASPHALT
 - = EXISTING STORM
 - = EXISTING SANITARY
 - = EXISTING WATER
 - = EXISTING GAS
 - = EXISTING ELECTRIC
 - = EXISTING TELEPHONE

BENCHMARK
 BM1=STEAMER VALVE ON HYDRANT IN FRONT OF 2575 S. STATE ST., ELEV=891.31.
 BM2=CITY OF ANN ARBOR NO. 0113 NORTH OF DRIVE TO 2555 S. STATE ST. AND ON EAST SIDE OF STATE ST., ELEV=887.49.

REVISIONS - 10-22-2013 PER CITY, 10-28-2013 PER CITY, 11-5-2013 PER CITY

CIVIL ENGINEERS
 PLANNERS & SURVEYORS
 LANDSCAPE ARCHITECTS
 3528 W. LIBERTY RD.
 ANN ARBOR, MI 48103
 TEL: 734-761-8800
 FAX: 734-761-8800
 WWW.WASHTENAWENGINEERING.COM

WASHTENAW ENGINEERING

ARCHITECTURAL ALLIANCE
 165 NORTH FIFTH ST
 COLUMBUS, OH 43215
 TEL: 614-469-7500
 FAX: 614-469-0500
 WWW.AAARCHIT.COM

CLIENT

PROJECT

SECTION 4 TOWN 3 SOUTH RANGE 6 EAST
 CITY OF ANN ARBOR
 WASHTENAW COUNTY - MICHIGAN

DATE 9-30-13
 JOB NO. 31667
 DWG NO. 667-2-1090
 FIELD BOOK 556 649
 FILE NO. 70227

2 SHEET

BOUNDARY & TOPOGRAPHICAL SURVEY

GERMAIN OF ANN ARBOR CAMPUS IMPROVEMENTS

THE UNDERGROUND UTILITIES SHOWN HAVE BEEN LOCATED FROM FIELD SURVEY INFORMATION AND EXISTING RECORDS. THE SURVEYORS MAKE NO GUARANTEE THAT THE UNDERGROUND UTILITIES SHOWN COMPARE ALL SUCH UTILITIES IN THE AREA, EITHER IN SERVICE OR ABANDONED. THE SURVEYOR FURTHER DOES NOT WARRANT THAT THE UNDERGROUND UTILITIES SHOWN ARE IN THE EXACT LOCATION INDICATED. ALTHOUGH THE SURVEYOR HAS MADE EVERY EFFORT TO LOCATE ALL UTILITIES AS ACCURATELY AS POSSIBLE FROM INFORMATION AVAILABLE, THE SURVEYOR HAS NOT PHYSICALLY LOCATED THE UNDERGROUND UTILITIES.

COPYRIGHT © 2013 WASHTENAW ENGINEERING COMPANY, INC. NO REPRODUCTION SHALL BE MADE WITHOUT PRIOR WRITTEN CONSENT OF WASHTENAW ENGINEERING COMPANY, INC.

THE OWNER SHALL NOT USE OR AUTHORIZE ANY OTHER PERSON TO USE THE DRAWINGS, SPECIFICATIONS, ELECTRONIC DATA AND ANY OTHER INFORMATION CONTAINED HEREIN FOR ANY PURPOSES WITHOUT THE WRITTEN CONSENT OF WASHTENAW ENGINEERING COMPANY, INC. ANY OTHER PERSON SHALL BE RESPONSIBLE FOR OBTAINING ALL NECESSARY PERMITS AND FOR OBTAINING ALL NECESSARY INFORMATION FROM THE CITY OF ANN ARBOR AND FROM THE STATE OF MICHIGAN. THE SURVEYOR HAS MADE EVERY EFFORT TO LOCATE ALL UTILITIES AS ACCURATELY AS POSSIBLE FROM INFORMATION AVAILABLE, BUT THE SURVEYOR HAS NOT PHYSICALLY LOCATED THE UNDERGROUND UTILITIES.

ANN ARBOR PUBLIC SCHOOLS ADMIN BLDG & PARKING LOT BUILDING

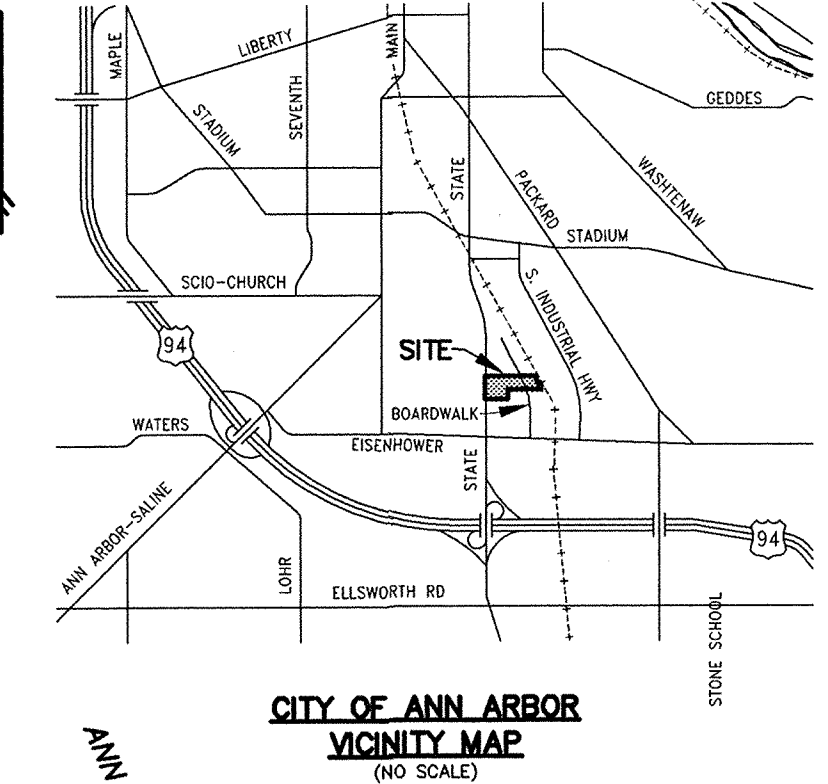
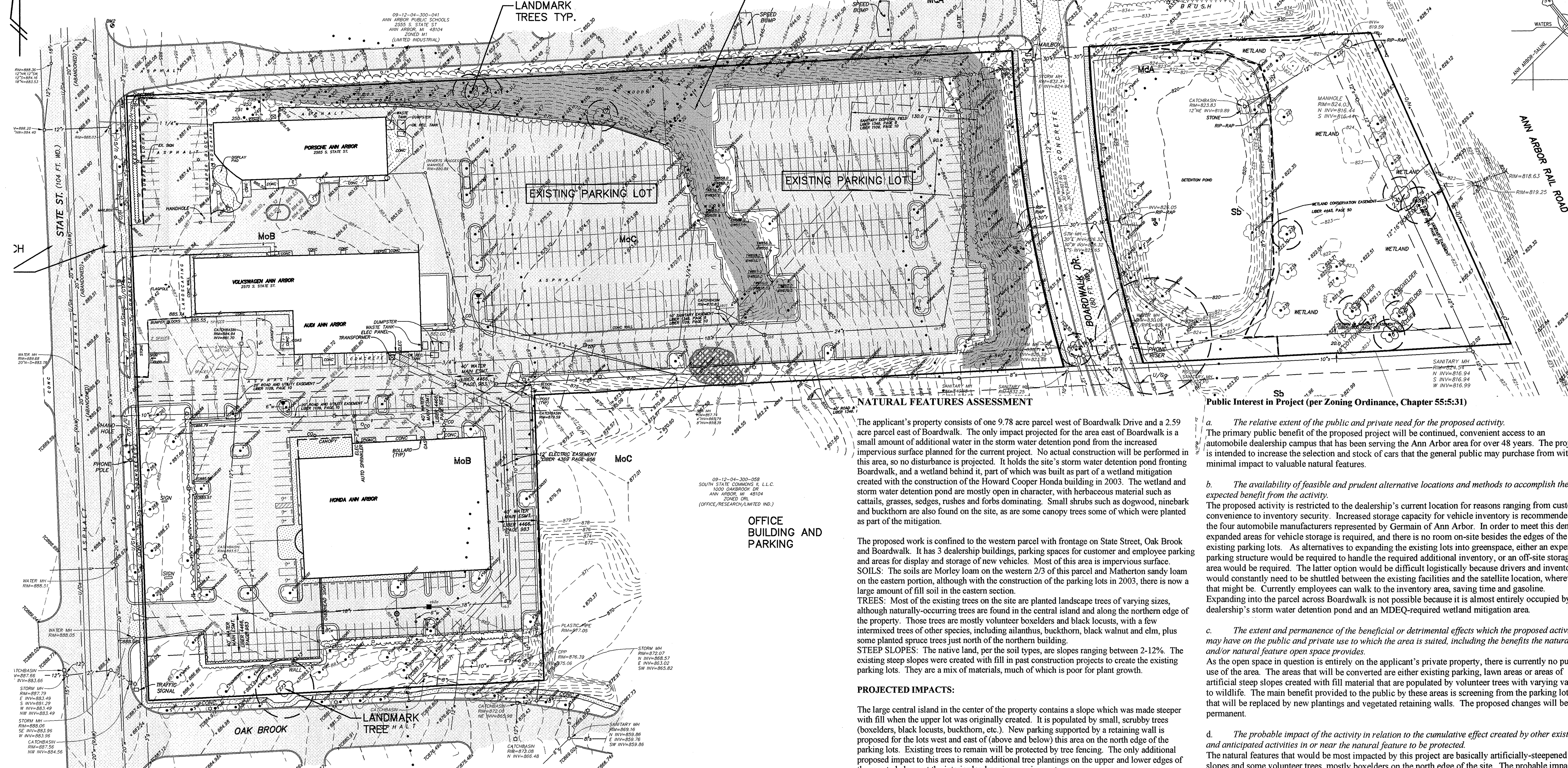

NATURAL FEATURES ASSESSMENT
Public Interest in Project (per Zoning Ordinance, Chapter 55:5:31)

a. The relative extent of the public and private need for the proposed activity. The primary public benefit of the proposed project will be continued, convenient access to an automobile dealership campus that has been serving the Ann Arbor area for over 48 years. The project is intended to increase the selection and stock of cars that the general public may purchase from with minimal impact to valuable natural features.

b. The availability of feasible and prudent alternative locations and methods to accomplish the expected benefit from the activity. The proposed activity is restricted to the dealership's current location for reasons ranging from customer convenience to inventory security. Increased storage capacity for vehicle inventory is recommended by the four automobile manufacturers represented by Germain of Ann Arbor. In order to meet this demand, expanded areas for vehicle storage is required, and there is no room on-site besides the edges of the existing parking lots. As alternatives to expanding the existing lots into greenspace, either an expensive parking structure would be required to handle the required additional inventory, or an off-site storage area would be required. The latter option would be difficult logistically because drivers and inventory would constantly need to be shuttled between the existing facilities and the satellite location, wherever that might be. Currently employees can walk to the inventory area, saving time and gasoline. Expanding into the parcel across Boardwalk is not possible because it is almost entirely occupied by the dealership's storm water detention pond and an MDEQ-required wetland mitigation area.

c. The extent and permanence of the beneficial or detrimental effects which the proposed activity may have on the public and private use to which the area is suited, including the benefits the natural and/or natural feature open space provides. The open space in question is entirely on the applicant's private property, there is currently no public use of the area. The areas that will be converted are either existing parking, lawn areas or areas of artificial steep slopes created with fill material that are populated by volunteer trees with varying value to wildlife. The main benefit provided to the public by these areas is screening from the parking lot, and that will be replaced by new plantings and vegetated retaining walls. The proposed changes will be permanent.

d. The probable impact of the activity in relation to the cumulative effect created by other existing and anticipated activities in or near the natural feature to be protected. The natural features that would be most impacted by this project are basically artificially-steepened slopes and some volunteer trees, mostly boxelders on the north edge of the site. The probable impact would be to fill some of the slopes and build retaining walls to support the increased vehicle storage areas. This impact basically continues a process begun years ago of changing the existing natural slope downhill from State Street toward the railroad tracks. The natural condition of the areas to be converted is poor.

e. The probable impact on recognized historical, cultural, scenic, ecological or recreational values, and on fish, wildlife and public health. The slopes and trees areas that will be most impacted by the proposed activity have little ecological value. The slopes are covered by volunteer black locust, buckthorn, boxelder and other trees and shrubs with low ecological value. Due to the poor soil and heavy shade there is little to no groundcover vegetation. There are no historical, cultural, scenic, ecological or recreational values on the site where development activity is proposed. The existing storm water detention pond is large enough to handle all of the proposed new impervious surface, so plants and animals depending on the storm water detention pond or adjacent wetland would also not be negatively impacted by this project.

The applicant's property consists of one 9.78 acre parcel west of Boardwalk Drive and a 2.59 acre parcel east of Boardwalk. The only impact projected for the area east of Boardwalk is a small amount of additional water in the storm water detention pond from the increased impervious surface planned for the current project. No actual construction will be performed in this area, so no disturbance is projected. It holds the site's storm water detention pond fronting Boardwalk, and a wetland behind it, part of which was built as part of a wetland mitigation created with the construction of the Howard Cooper Honda building in 2003. The wetland and storm water detention pond are mostly open in character, with herbaceous material such as cattails, grasses, sedges, rushes and forbs dominating. Small shrubs such as dogwood, ninebark and buckthorn are also found on the site, as are some canopy trees some of which were planted as part of the mitigation.

The proposed work is confined to the western parcel with frontage on State Street, Oak Brook and Boardwalk. It has 3 dealership buildings, parking spaces for customer and employee parking and areas for display and storage of new vehicles. Most of this area is impervious surface. SOILS: The soils are Morley loam on the western 2/3 of this parcel and Matherton sandy loam on the eastern portion, although with the construction of the parking lots in 2003, there is now a large amount of fill soil in the eastern section. TREES: Most of the existing trees on the site are planted landscape trees of varying sizes, although naturally-occurring trees are found in the central island and along the northern edge of the property. Those trees are mostly volunteer boxelders and black locusts, with a few intermixed trees of other species, including ailanthus, buckthorn, black walnut and elm, plus some planted spruce trees just north of the northern building. STEEP SLOPES: The native land, per the soil types, are slopes ranging between 2-12%. The existing steep slopes were created with fill in past construction projects to create the existing parking lots. They are a mix of materials, much of which is poor for plant growth.

PROJECTED IMPACTS:
The large central island in the center of the property contains a slope which was made steeper with fill when the upper lot was originally created. It is populated by small, scrubby trees (boxelders, black locusts, buckthorn, etc.). New parking supported by a retaining wall is proposed for the lots west and east of (above and below) this area on the north edge of the parking lots. Existing trees to remain will be protected by tree fencing. The only additional proposed impact to this area is some additional tree plantings on the upper and lower edges of the area to help meet the interior landscaping requirements.

A steep (non-natural) slope on the north side of the property will be impacted by the expansion of the northern building and vehicle storage parking behind it. Most of the trees on that slope that will be removed for the expansion are non-landmark-sized volunteers but there are three multi-stem boxelders (*Acer negundo*) that have a total equivalent dbh of 52.8in. Landscape trees along the Honda dealership's State Street, Boardwalk and Oak Brook Street parking lots will also be removed with the expansion of those lots. New trees will be planted to replace them. Retaining walls will be built on the steep slopes to support the additional parking. Those walls will be "living walls" which allow for plants to be planted within the wall to provide a more aesthetic appearance.

NATURAL FEATURES PROTECTION/MITIGATION
The three landmark multiple stem boxelder trees on the north side of the site would be removed to expand the upper parking lot to the north. Their total equivalent size is 52.8" dbh. Five Blackgum (*Nyssa sylvatica*), three (3) Hackberry (*Celtis occidentalis*) and three (3) Tuliptrees (*Liriodendron tulipifera*) are proposed as mitigation in the setback between the parking lot and Boardwalk, which will create additional screening of the parking lot. In addition, there is a landmark honeylocust tree near the site's southwest corner and three other landmark boxelders on the site that will be saved. They will be protected by tree fencing with this project, and no negative impact to it is expected as the proposed work is further than 10' from its trunk. Should any of these trees die within three years of the project, per city ordinance, they will be replaced with a combination of Blackgum, Hackberry and Swamp White Oak (*Quercus bicolor*).

ALTERNATIVES CONSIDERED TO MINIMIZE IMPACTS
The primary source of impact on the site's natural features is the expansion of the parking lots for storage of vehicles. In order to gain the number of parking spaces provided by this plan, a parking deck would have to be built. To provide the number of spaces proposed for this project, a three story structure with a footprint of approximately 75,000 square feet (shown on this plan) would be required. The cost of a parking deck would be approximately \$18,000 per space (source: <http://www.reedconstructiondata.com/rsmems/models/garage/>), which is far beyond the available budget for this project. As a result, this option was not considered as viable.

The only other option to gain the number of spaces needed would be to purchase another property off-site for the additional capacity. This would require a large inefficiency in operations and use of resources as vehicles and employees would have to be shuttled back and forth between sites, and the amount of total impervious surface would be no less.

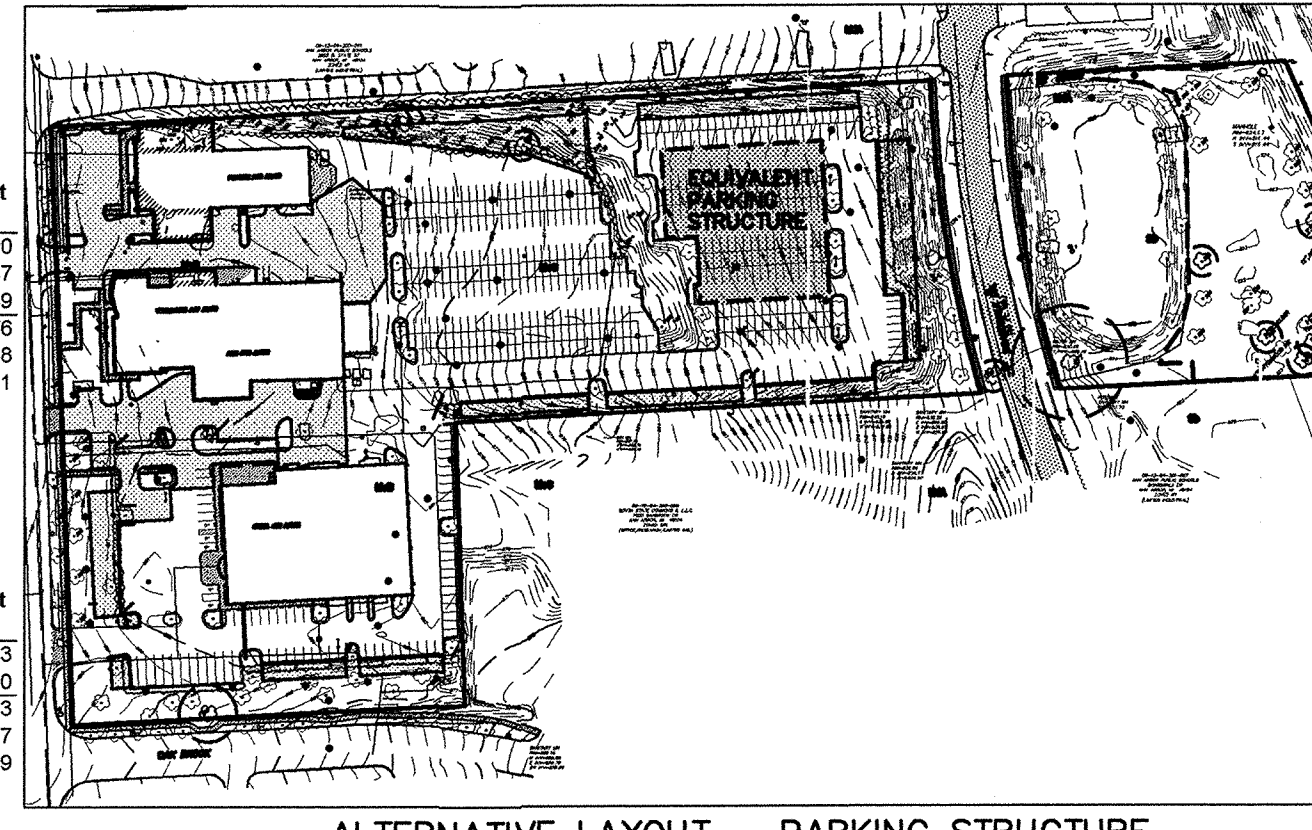

LANDMARK TREE MITIGATION CALCULATIONS
(Mitigation trees shown on Landscape Plan)

Scientific name	Common name	Tree #	Size (in dbh)	Equivalent dbh
<i>Acer negundo</i>	Boxelder	150	15"	18.00
<i>Acer negundo</i>	Boxelder	310	16", 10"	18.87
<i>Acer negundo</i>	Boxelder	311	16", 8"	17.89
Required mitigation				52.76
# 2.5" cal. Mitigation trees required				11

Mitigation trees proposed:
 (3) 2.5" cal. Nyssa sylvatica (Blackgum)
 (3) 2.5" cal. Celtis occidentalis (Hackberry)
 (3) 2.5" cal. Liriodendron tulipifera (Tuliptree)

TREES WITH WORK IN CRITICAL ROOT ZONE TO BE SAVED

Scientific name	Common name	Tree #	Size (in dbh)	Equivalent dbh
<i>Acer negundo</i>	Boxelder	175	12", 10", 6"	16.73
<i>Gleditsia triacanthos</i>	Honeylocust	273	24"	40.73
Required mitigation (maximum)				20.37
# Mitigation trees required (maximum)				9

LOCATION OF MITIGATION TREES TO BE PLANTED ARE SHOWN ON LANDSCAPE PLAN.

ALTERNATIVE LAYOUT - PARKING STRUCTURE
SCALE: 1"=200'

WASHTENAW COUNTY SOIL SURVEY CLASSIFICATION

- MdA - MATHERTON SANDY LOAM, 0 TO 4 PCT SLOPES
- MdC - MORLEY LOAM, 2 TO 6 PCT SLOPES
- MdD - MORLEY LOAM, 6 TO 12 PCT SLOPES
- Sb - SEWABO LOAM
- - SOILS BOUNDARY

SOILS ARE BASED ON USDA SOIL SURVEY OF WASHTENAW COUNTY.



LEGEND

○ = LIGHT POLE	● = SPOT ELEV.	--- = GRAVEL	--- = EXISTING STORM
○ = UTILITY POLE	○ = POST	--- = FENCE	--- = EXISTING SANITARY
○ = GUY ANCHOR	○ = GATE VALVE	--- = CONCRETE	--- = EXISTING WATER
○ = HYDRANT	○ = SIGN	--- = ASPHALT	--- = EXISTING GAS
			--- = EXISTING ELECTRIC
			--- = EXISTING TELEPHONE

BENCHMARK
BM1-STEAMER VALVE ON HYDRANT IN FRONT OF 2575 S. STATE ST., ELEV=891.31
BM2-CITY OF ANN ARBOR NO. 0113 NORTH OF DRIVE TO 2555 S. STATE ST. AND ON EAST SIDE OF STATE ST., ELEV=887.49

REVISIONS - 10-22-2013 PER CITY, 10-28-2013 PER CITY, 11-5-2013 PER CITY

NO.	DATE	DESCRIPTION

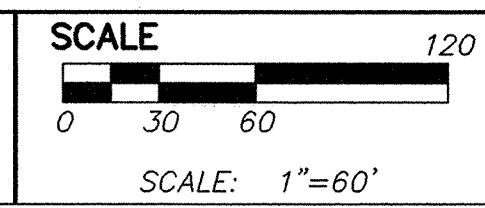

PREPARED BY: Robert J. Wanty
ROBERT J. WANTY P.E., MICH No. 28666



Know what's below. Call before you dig.

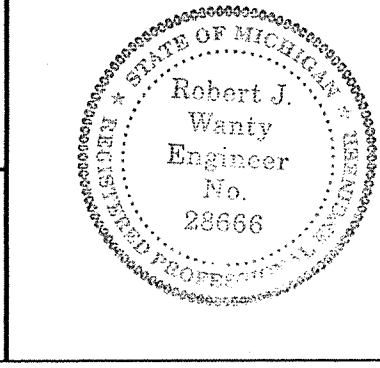

WASHTENAW ENGINEERING
CIVIL ENGINEERS
PLANNERS • SURVEYORS
LANDSCAPE ARCHITECTS
3526 W. LIBERTY RD
ANN ARBOR, MI 48103
TEL: 734-761-9530
FAX: 734-761-9530
WWW.WASHTENAWENGINEERING.COM

ARCHITECTURAL ALLIANCE
165 NORTH PLYMOUTH ST
ANN ARBOR, MI 48106
TEL: 734-469-7500
FAX: 734-469-0500
www.archall.com

NATURAL FEATURES ANALYSIS

GERMAIN OF ANN ARBOR CAMPUS IMPROVEMENTS

SECTION 4 TOWN 3 SOUTH RANGE 6 EAST
CITY OF ANN ARBOR
WASHTENAW COUNTY - MICHIGAN
JOB NO. 37667
DWS NO. 667-3-NATEAT
FIELD BOOK 556, 649
FILE NO. 10027

DATE 9-30-13
SHEET 3

THE UNDERGROUND UTILITIES SHOWN HAVE BEEN LOCATED FROM FIELD SURVEY INFORMATION AND EXISTING RECORDS. THE SURVEYOR MAKES NO GUARANTEE THAT THE UNDERGROUND UTILITIES SHOWN COMPRISE ALL SUCH UTILITIES IN THE AREA. EITHER IN-SERVICE OR ABANDONED. THE SURVEYOR HAS NOT WARRANTEED THAT THE UNDERGROUND UTILITIES SHOWN ARE IN THE EXACT LOCATION INDICATED. ALL UTILITIES SHOWN ARE TO BE REMOVED UNLESS OTHERWISE NOTED. THE SURVEYOR HAS NOT PHYSICALLY LOCATED THE UNDERGROUND UTILITIES.

THE OWNER SHALL NOT USE ANY INSTRUMENTS OR OTHER RECORDS IN THE DESIGN OR CONSTRUCTION OF THIS PROJECT WITHOUT THE WRITTEN CONSENT OF WASHTEANAW ENGINEERING COMPANY, INC. ANY INSTRUMENTS OR OTHER RECORDS FOR THIS PROJECT OR FOR COMPLETION OF THE PROJECT BY OTHERS SO LONG AS WASHTEANAW ENGINEERING COMPANY (WECO) IS NOT ADDED TO BE IN DEFAULT UNDER THIS AGREEMENT. THE SURVEYOR SHALL BE RESPONSIBLE FOR THE DESIGN AND CONSTRUCTION OF THIS PROJECT. THE SURVEYOR SHALL BE RESPONSIBLE FOR THE DESIGN AND CONSTRUCTION OF THIS PROJECT. THE SURVEYOR SHALL BE RESPONSIBLE FOR THE DESIGN AND CONSTRUCTION OF THIS PROJECT.

WASHTEANAW ENGINEERING COMPANY, INC.
 3526 W. LIBERTY RD.
 SUITE 400
 ANN ARBOR, MI 48103
 TEL 734-761-9530
 FAX 734-761-9530
 WWW.WASHTEANAWENGINEERING.COM

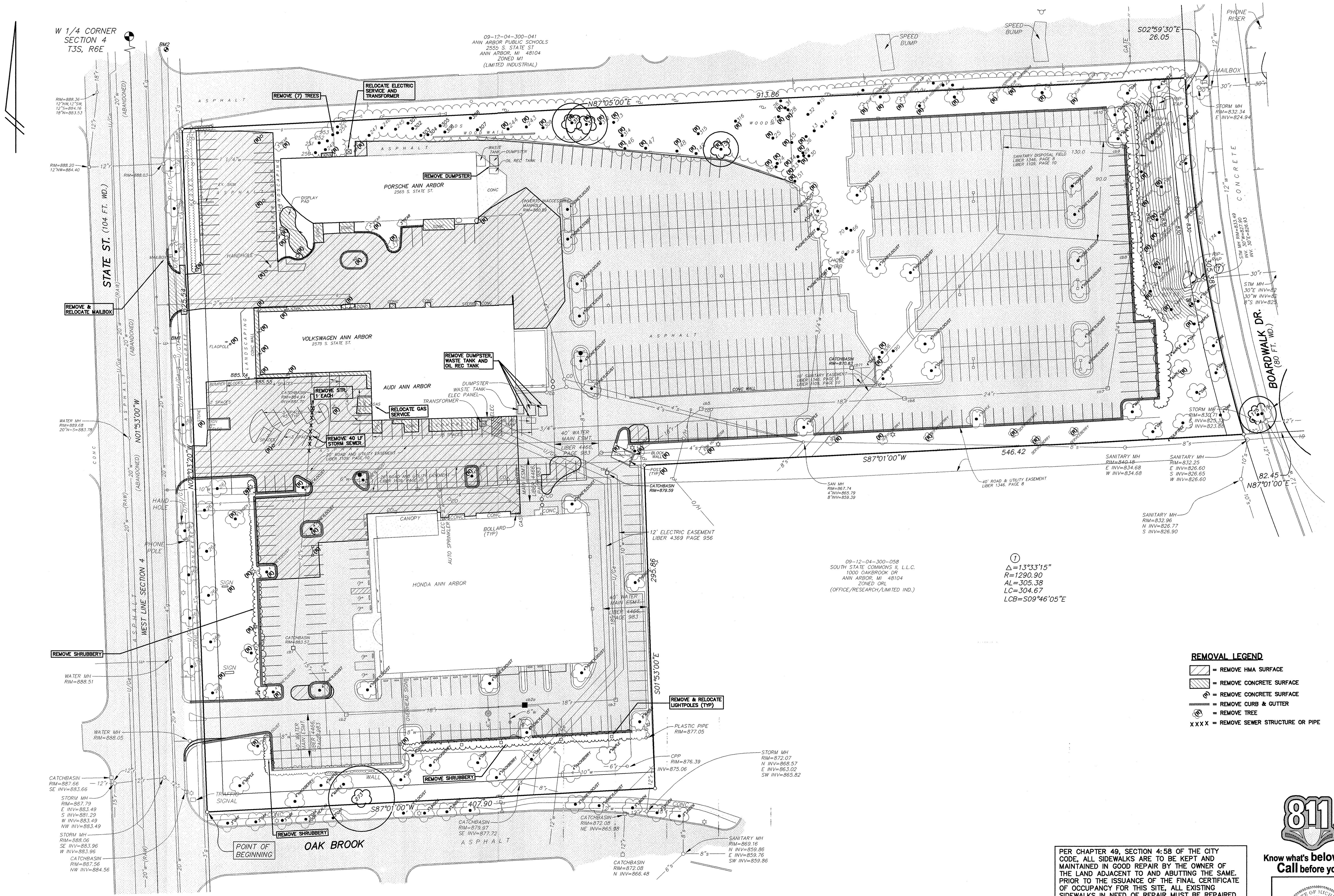

LEGEND	<ul style="list-style-type: none"> ☉ = LIGHT POLE ☉ = UTILITY POLE ☉ = GUY ANCHOR ☉ = HYDRANT ● = SPOT ELEV. ⊙ = POST ⊙ = GATE VALVE ⊙ = SIGN TC = TOP OF CURB TW = TOP OF WALL --- = GRAVEL --- = FENCE --- = CONCRETE --- = ASPHALT f = EXISTING STORM w = EXISTING SANITARY g = EXISTING GAS e = EXISTING ELECTRIC t = EXISTING TELEPHONE
---------------	---

BENCHMARK
 BM1-STEAMER VALVE ON HYDRANT IN FRONT OF 2575 S. STATE ST., ELEV=891.31.
 BM2-CITY OF ANN ARBOR NO. 0113 NORTH OF DRIVE TO 2555 S. STATE ST. AND ON EAST SIDE OF STATE ST., ELEV=887.49.

REVISIONS - 10-22-2013 PER CITY, 10-28-2013 PER CITY, 11-5-2013 PER CITY

NO.	DATE	DESCRIPTION

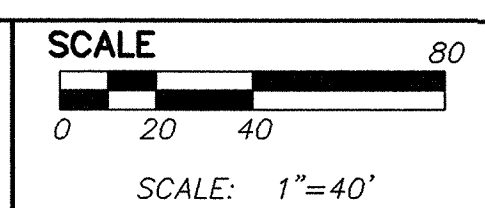

PER CHAPTER 49, SECTION 4-58 OF THE CITY CODE, ALL SIDEWALKS ARE TO BE KEPT AND MAINTAINED IN GOOD REPAIR BY THE OWNER OF THE LAND ADJACENT TO AND ABUTTING THE SAME. PRIOR TO THE ISSUANCE OF THE FINAL CERTIFICATE OF OCCUPANCY FOR THIS SITE, ALL EXISTING SIDEWALKS IN NEED OF REPAIR MUST BE REPAIRED IN ACCORDANCE WITH CITY STANDARDS.

PREPARED BY: *Robert J. Wanty*
 ROBERT J. WANTY P.E., MICH. NO. 28666

811
 Know what's below.
 Call before you dig.

GERMAIN OF ANN ARBOR CAMPUS IMPROVEMENTS

SECTION 4 TOWN 3 SOUTH RANGE 6 EAST
 CITY OF ANN ARBOR
 WASHTEANAW COUNTY, MICHIGAN
 DATE 9-30-13 JOB NO. 31667
 DWS NO. 667-4-rem FIELD BOOK 556, 649
 FILE NO. 10027

REMOVAL PLAN

ARCHITECTURAL ALLIANCE
 165 NORTH FEHL ST
 COLUMBUS, OH 43215
 TEL 614-469-7500
 FAX 614-469-0500
 www.archall.com

PROJECT SHEET

PREVIOUS VARIANCES:
 1. DECEMBER 20, 2000 - GRANTED A VARIANCE FROM THE OFF-STREET PARKING ORDINANCE TO ALLOW THE EAST PARKING AREA (AUTO STORAGE) TO HAVE (1) STACKED PARKING, (2) 20-FT. AISLE-WAYS AND (3) 8-FT. X 16-FT. SPACES FOR THE STORAGE OF AUTOMOBILES. (1) IN THE CASE OF STACKED PARKING, A VARIANCE TO ALLOW 114 STACKED SPACES. (2) IN THE CASE OF 20-FT. AISLE-WAYS, A VARIANCE OF 4-FT. FROM THE 24-FT. AISLE-WAY TO ALLOW 20-FT. AISLE-WAYS IN THIS STORAGE AREA. (3) IN THE CASE OF SPACE SIZE, A VARIANCE OF 28% FROM THE 30% PERMITTED SMALL CAR SPACES TO ALLOW 58% OF PARKING TO BE SMALL CAR, MANY WITHIN THIS STORAGE AREA.
 2. AUGUST 27, 2003 - GRANTED A VARIANCE OF 1 FT. FROM THE 9 FT. PARKING STALL WIDTH, 2 FT. FROM THE PARKING AISLE WIDTH AND TO ALLOW STACKED PARKING PER SITE PLAN FOR THIS AUTOMOBILE SALES STORAGE AREA.
 3. MAY 25, 2005 - GRANTED A VARIANCE FROM THE REQUIRED FRONT YARD SETBACK TO ALLOW STACKED PARKING AT A LOCATION WHERE IT REQUIRES A VARIANCE OF 20.2 FEET FROM THE OAKBROOK SETBACK WHERE 52.7 FEET WOULD BE REQUIRED. THE VARIANCE IS GRANTED FOR 13 PARKING SPACES IN THE FRONT SETBACK THAT DID PREVIOUSLY EXIST. POROUS PAVERS WILL BE USED IN THE ENTIRE FRONT STACKED AREA.

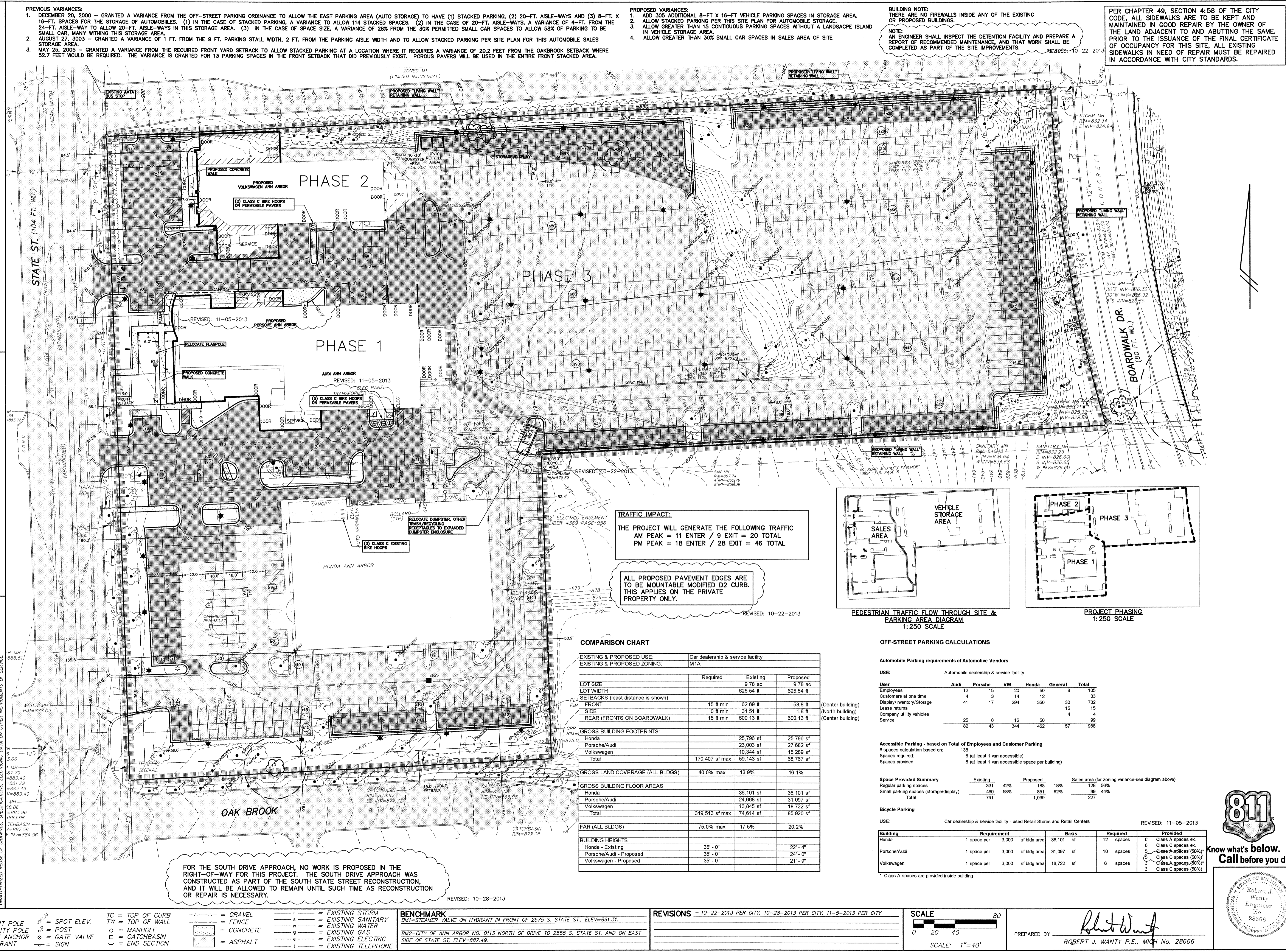

- PROPOSED VARIANCES:
 1. ADD 305 ADDITIONAL 8-FT X 16-FT VEHICLE PARKING SPACES IN STORAGE AREA.
 2. ALLOW STACKED PARKING PER THIS SITE PLAN FOR AUTOMOBILE STORAGE.
 3. ALLOW GREATER THAN 15 CONTIGUOUS PARKING SPACES WITHOUT A LANDSCAPE ISLAND IN VEHICLE STORAGE AREA.
 4. ALLOW GREATER THAN 30% SMALL CAR SPACES IN SALES AREA OF SITE

BUILDING NOTE:
 THERE ARE NO FIREWALLS INSIDE ANY OF THE EXISTING OR PROPOSED BUILDINGS.
 NOTE:
 AN ENGINEER SHALL INSPECT THE DETENTION FACILITY AND PREPARE A REPORT OF RECOMMENDED MAINTENANCE, AND THAT WORK SHALL BE COMPLETED AS PART OF THE SITE IMPROVEMENTS.

PER CHAPTER 49, SECTION 4-5B OF THE CITY CODE, ALL SIDEWALKS ARE TO BE KEPT AND MAINTAINED IN GOOD REPAIR BY THE OWNER OF THE LAND ADJACENT TO AND ABUTTING THE SAME. PRIOR TO THE ISSUANCE OF THE FINAL CERTIFICATE OF OCCUPANCY FOR THIS SITE, ALL EXISTING SIDEWALKS IN NEED OF REPAIR MUST BE REPAIRED IN ACCORDANCE WITH CITY STANDARDS.

TRAFFIC IMPACT:
 THE PROJECT WILL GENERATE THE FOLLOWING TRAFFIC
 AM PEAK = 11 ENTER / 9 EXIT = 20 TOTAL
 PM PEAK = 18 ENTER / 28 EXIT = 46 TOTAL

ALL PROPOSED PAVEMENT EDGES ARE TO BE MOUNTABLE MODIFIED D2 CURB. THIS APPLIES TO THE PRIVATE PROPERTY ONLY.

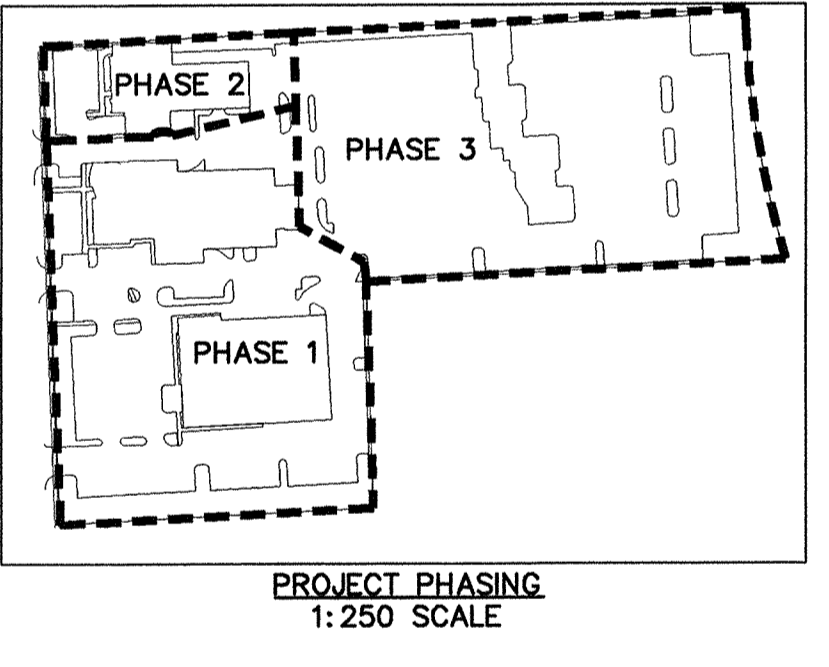
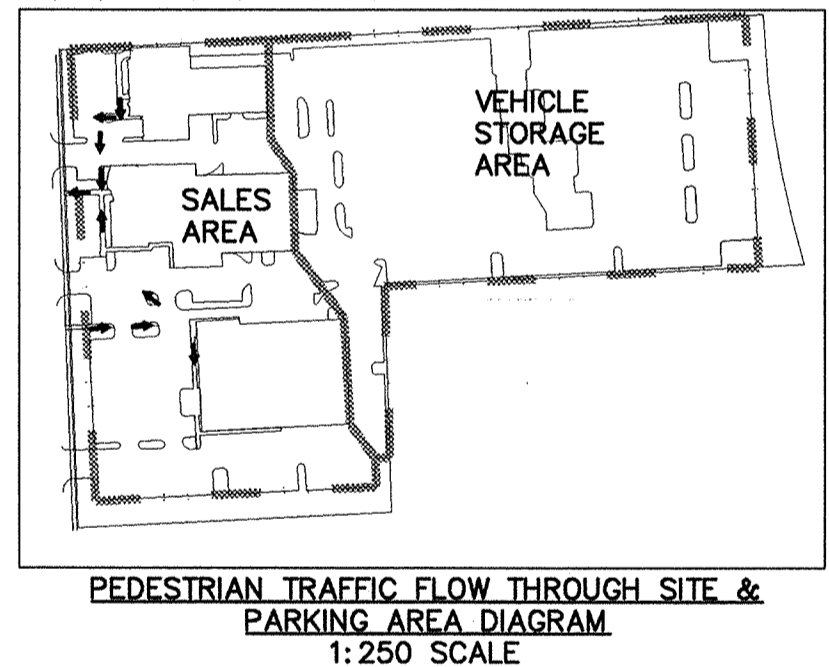

COMPARISON CHART

EXISTING & PROPOSED USE: EXISTING & PROPOSED ZONING:	Car dealership & service facility M1A		
	Required	Existing	Proposed
LOT SIZE		9.78 ac	9.78 ac
LOT WIDTH		625.54 ft	625.54 ft
SETBACKS (least distance is shown)			
FRONT	15 ft min	62.69 ft	53.8 ft
SIDE	0 ft min	31.51 ft	1.8 ft
REAR (FRONTS ON BOARDWALK)	15 ft min	600.13 ft	600.13 ft
GROSS BUILDING FOOTPRINTS:			
Honda		25,796 sf	25,796 sf
Porsche/Audi		23,003 sf	27,682 sf
Volkswagen		10,344 sf	15,289 sf
Total	170,407 sf max	59,143 sf	68,767 sf
GROSS LAND COVERAGE (ALL BLDGS)	40.0% max	13.9%	16.1%
GROSS BUILDING FLOOR AREAS:			
Honda		36,101 sf	36,101 sf
Porsche/Audi		24,668 sf	31,097 sf
Volkswagen		13,845 sf	18,722 sf
Total	319,513 sf max	74,614 sf	85,920 sf
FAR (ALL BLDGS)	75.0% max	17.8%	20.2%
BUILDING HEIGHTS			
Honda - Existing	35' - 0"		22' - 4"
Porsche/Audi - Proposed	35' - 0"		24' - 0"
Volkswagen - Proposed	35' - 0"		21' - 0"

OFF-STREET PARKING CALCULATIONS

Automobile Parking requirements of Automotive Vendors

USE: Automobile dealership & service facility

User	Audi	Porsche	VW	Honda	General	Total
Employees	12	15	20	50	8	105
Customers at one time	4	3	14	12	33	33
Display/Inventory/Storage	41	17	294	350	30	732
Lease return				15	15	15
Company utility vehicles				4	4	4
Service	25	8	16	50	99	99
	82	43	344	462	57	988

Accessible Parking - based on Total of Employees and Customer Parking

spaces calculation based on:
 Spaces required: 5 (at least 1 van accessible)
 Spaces provided: 6 (at least 1 van accessible space per building)

Space Provided Summary	Existing	Proposed	Required	Percentage
Regular parking spaces	331	42%	188	57%
Small parking spaces (storage/display)	460	58%	851	54%
Total	791	1,039	99	44%

Bicycle Parking

USE: Car dealership & service facility - used Retail Stores and Retail Centers

Building	Requirement	Basis	Required	Provided
Honda	1 space per 5,000 sf bldg area	36,101 sf	7	6 Class A spaces ex. 6 Class C spaces ex.
Porsche/Audi	1 space per 3,000 sf bldg area	31,097 sf	10	5 Class A spaces (50%) 5 Class C spaces (50%)
Volkswagen	1 space per 3,000 sf bldg area	18,722 sf	6	3 Class A spaces (60%) 3 Class C spaces (40%)

FOR THE SOUTH DRIVE APPROACH, NO WORK IS PROPOSED IN THE RIGHT-OF-WAY FOR THIS PROJECT. THE SOUTH DRIVE APPROACH WAS CONSTRUCTED AS PART OF THE SOUTH STATE STREET RECONSTRUCTION, AND IT WILL BE ALLOWED TO REMAIN UNTIL SUCH TIME AS RECONSTRUCTION OR REPAIR IS NECESSARY.

LEGEND

- Light Pole
- Utility Pole
- Guy Anchor
- Hydrant
- Spot Elev.
- Post
- Gate Valve
- Sign
- Top of Curb
- Top of Wall
- Gravel
- Fence
- Manhole
- Catchbasin
- End Section
- Existing Storm
- Existing Sanitary
- Existing Water
- Existing Gas
- Existing Electric
- Existing Telephone

BENCHMARK
 BM1=STEAMER VALVE ON HYDRANT IN FRONT OF 2575 S. STATE ST., ELEV=891.31.
 BM2=CITY OF ANN ARBOR NO. 0113 NORTH OF DRIVE TO 2555 S. STATE ST. AND ON EAST SIDE OF STATE ST., ELEV=887.49.

REVISIONS - 10-22-2013 PER CITY, 10-28-2013 PER CITY, 11-5-2013 PER CITY

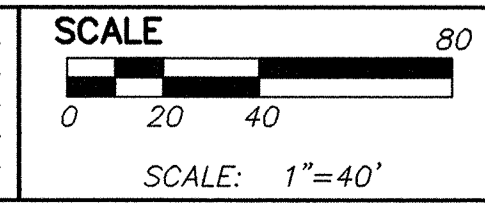

PREPARED BY: Robert J. Wanty, P.E., MICH No. 28666

811 Know what's below. Call before you dig.

Robert J. Wanty, P.E., MICH No. 28666

SECTION 4 TOWN 3 SOUTH RANGE 6 EAST
 CITY OF ANN ARBOR
 WASHINGTON COUNTY, MICHIGAN
 JOB NO. 31667
 DATE 9-30-13
 DWG NO. 667-5-518
 FIELD BOOK 556, 649
 FILE NO. 10027

PROJECT: GERMAIN OF ANN ARBOR CAMPUS IMPROVEMENTS

SHEET: 5

CLIENT: ARCHITECTURAL ALLIANCE
 165 NORTH FIFTH ST
 COLUMBUS, OH 43215
 TEL: 614-459-0000
 www.aalliance.com

WASHTENAW ENGINEERING
 CIVIL ENGINEERS SURVEYORS
 LANDSCAPE ARCHITECTS
 3528 W. LIBERTY RD.
 SUITE 400
 ANN ARBOR, MI 48103
 TEL: 734-761-8800
 FAX: 734-761-8800
 www.washtenawengineering.com

CIVIL ENGINEERS
PLANNERS • SURVEYORS
LANDSCAPE ARCHITECTS
3528 W. LIBERTY RD
SUITE 400
ANN ARBOR, MI 48103
TEL 734-761-8800
FAX 734-761-8830
WWW.WASHTENAWENGINEERING.COM

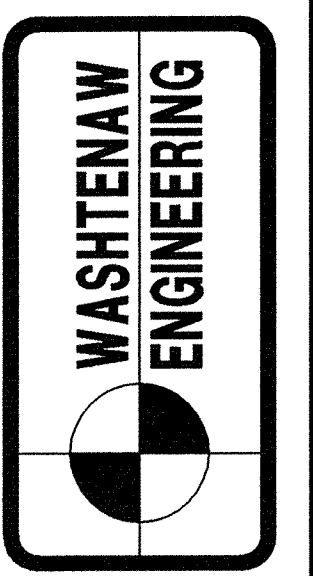

ARCHITECTURAL ALLIANCE
165 NORTH FIFTH ST
COLUMBUS, OH 43215
TEL 614-469-7500
FAX 614-469-0500
www.aacall.com

CLIENT
GRADING AND SOIL EROSION CONTROL PLAN

SHEET
GERMAIN OF ANN ARBOR CAMPUS IMPROVEMENTS

PROJECT
SECTION 4 TOWN 3 SOUTH RANGE 6 EAST
CITY OF ANN ARBOR
WASHTENAW COUNTY • MICHIGAN
JOB NO. 31667
DATE 9-30-13
FIELD BOOK 556, 649
FILE NO. 10027
SHEET 6

W 1/4 CORNER SECTION 4 T3S, R6E

STATE ST. (104 FT. WD.)

BOARDWALK DR. (80 FT. WD.)

OAK BROOK

ANN ARBOR PUBLIC SCHOOLS
2555 S. STATE ST.
ANN ARBOR, MI 48104
ZONED M1 (LIMITED INDUSTRIAL)

REVISIONS - 10-22-2013 PER CITY, 10-28-2013 PER CITY, 11-5-2013 PER CITY

SCALE 1"=40'

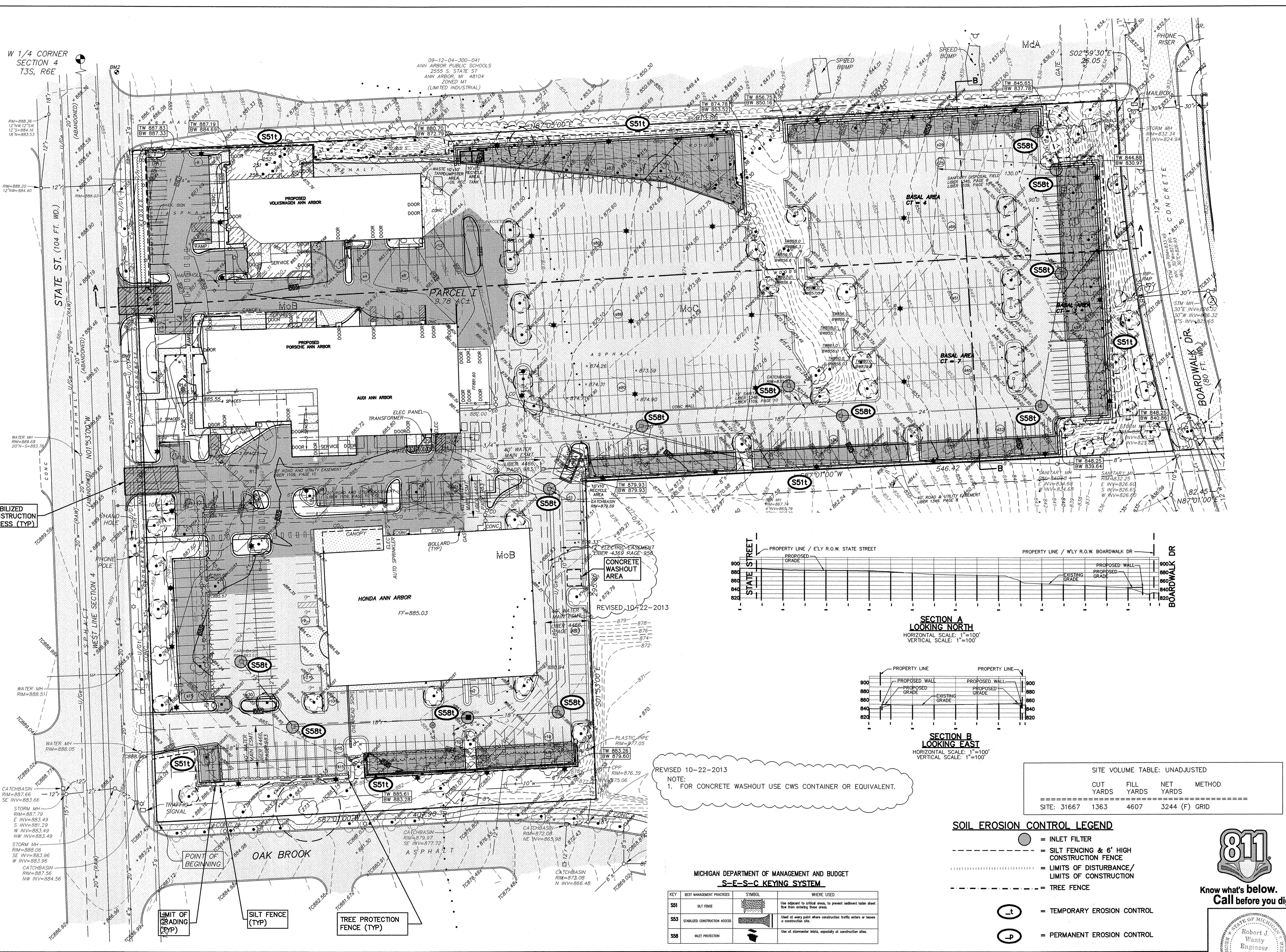

STABILIZED CONSTRUCTION ACCESS (TYP)

CONCRETE WASHOUT AREA

SECTION A LOOKING NORTH

SECTION B LOOKING EAST

SOIL EROSION CONTROL LEGEND

KEY	BEST MANAGEMENT PRACTICES	SYMBOL	WHERE USED
S51	SILT FENCE	[Symbol]	Use adjacent to critical areas, to prevent sediment from sheet flow striking these areas.
S53	STABILIZED CONSTRUCTION ACCESS	[Symbol]	Used at every point where construction traffic enters or leaves a construction site.
S58	INLET PROTECTION	[Symbol]	Use of stormwater inlets, especially at construction sites.

NOTE:
1. FOR CONCRETE WASHOUT USE CWS CONTAINER OR EQUIVALENT.

SITE VOLUME TABLE: UNADJUSTED

CUT YARDS	FILL YARDS	NET YARDS	METHOD
31667	1363	4607	3244 (F) GRID

MICHIGAN DEPARTMENT OF MANAGEMENT AND BUDGET
S-E-S-C KEYING SYSTEM

REVISIONS - 10-22-2013 PER CITY, 10-28-2013 PER CITY, 11-5-2013 PER CITY

SCALE 1"=40'

PREPARED BY
ROBERT J. WANTY P.E., MICH No. 28666

Know what's below.
Call before you dig.

Robert J. Wanty
Engineer No. 28666

STATE OF MICHIGAN
Robert J. Wanty
Engineer No. 28666

THE UNDERGROUND UTILITIES SHOWN HAVE BEEN LOCATED FROM FIELD SURVEY, INFORMATION AND EXISTING RECORDS. THE SURVEYOR MAKES NO GUARANTEE THAT THE UNDERGROUND UTILITIES SHOWN COMPARE TO THE ACTUAL UTILITIES IN THE AREA, EITHER IN SERVICE OR ABANDONED. THE SURVEYOR DOES NOT WARRANT THAT THE UTILITIES SHOWN ARE ACCURATELY LOCATED AS SHOWN OR THAT THERE ARE NO OTHER UTILITIES IN THE AREA. THE SURVEYOR HAS NOT PHYSICALLY LOCATED THE UNDERGROUND UTILITIES.

THE OWNER SHALL NOT USE OR ALLOW ANY OTHER PERSON TO USE THE SERVICES, INFORMATION, ELECTRONIC DATA, AND OTHER INSTRUMENTS OF SERVICE ON OTHER PROJECTS, FOR ADDITION TO THIS PROJECT OR FOR COMPLETION OF THE PROJECT. BY OTHERS SO LONG AS WASHTENAW ENGINEERING COMPANY (WEC) IS NOT ADVISED TO BE IN DEFAULT UNDER THIS AGREEMENT. WEC SHALL BE RESPONSIBLE FOR THE PROTECTION OF ALL UTILITIES SHOWN ON THIS PLAN. THE SURVEYOR SHALL BE RESPONSIBLE FOR THE PROTECTION OF ALL UTILITIES SHOWN ON THIS PLAN. THE SURVEYOR SHALL BE RESPONSIBLE FOR THE PROTECTION OF ALL UTILITIES SHOWN ON THIS PLAN.

THE SURVEYOR SHALL NOT BE RESPONSIBLE FOR THE PROTECTION OF ANY UTILITIES NOT SHOWN ON THIS PLAN. THE SURVEYOR SHALL NOT BE RESPONSIBLE FOR THE PROTECTION OF ANY UTILITIES NOT SHOWN ON THIS PLAN. THE SURVEYOR SHALL NOT BE RESPONSIBLE FOR THE PROTECTION OF ANY UTILITIES NOT SHOWN ON THIS PLAN.

LEGEND
 * = LIGHT POLE
 ○ = UTILITY POLE
 ⊕ = GUY ANCHOR
 ⊕ = HYDRANT
 ● = SPOT ELEV.
 ○ = POST
 ⊕ = GATE VALVE
 ⊕ = SIGN

TC = TOP OF CURB
 TW = TOP OF WALL
 ○ = MANHOLE
 □ = CATCHBASIN
 ⊕ = END SECTION

--- = GRAVEL
 --- = FENCE
 --- = CONCRETE
 --- = ASPHALT

f = EXISTING STORM
 s = EXISTING SANITARY
 w = EXISTING WATER
 g = EXISTING GAS
 e = EXISTING ELECTRIC
 t = EXISTING TELEPHONE

BENCHMARK
 BM1=STEAMER VALVE ON HYDRANT IN FRONT OF 2575 S. STATE ST., ELEV=891.31
 BM2=CITY OF ANN ARBOR NO. 0113 NORTH OF DRIVE TO 2555 S. STATE ST. AND ON EAST SIDE OF STATE ST., ELEV=887.49

SOIL EROSION AND SEDIMENTATION CONTROL NOTES GENERAL

- The contractor shall implement and maintain the soil erosion control measures as shown on the plans at all times during construction on this project. Any modifications or additions to the soil erosion control measures due to construction or changed conditions, shall be complied with as required or directed by the Owner, Project Engineer or the City of Ann Arbor.
- All soil erosion and sedimentation control work shall conform to the permit requirements of the City of Ann Arbor and the laws of the State of Michigan.
- A NPDES Construction Activity Permit is required for all sites with soil disturbance greater than 5 acres.
- Daily inspections shall be made by the Contractor. Periodic inspections may be made by the Owner/Project Engineer/Township to determine the effectiveness of erosion and sedimentation control measures. Any necessary corrections shall be made without delay.
- Erosion and sedimentation from work on the site shall be contained on the site and not be allowed to collect on any off-site areas or in waterways.
- All mud/dirt tracked onto roads from the site due to construction, shall be promptly removed by the Contractor. External streets will be cleaned of any tracked mud immediately following each mud-tracking occurrence.
- Restoration of all disturbed areas, including placement of topsoil, seed, fertilizer and mulch and/or sod shall be done within 15 days of the completion of final grade.
- Construction operations shall be scheduled and performed so that preventive soil erosion control measures are in place prior to excavation in critical areas and temporary stabilization measures are in place immediately following backfilling operations.
- Special precautions will be taken in the use of construction equipment to prevent situations that promote erosion.
- Proper dust control shall be maintained during construction by use of water trucks and/or chloride as required.
- The Contractor shall be responsible for maintaining all temporary soil erosion control measures and removal of some upon authorized completion of project. Completion of project will not be authorized until all site work, home building, road work and utility construction is complete and all soils are stabilized.

CONSTRUCTION SEQUENCE

- JAN. 17, 2014 - SOIL EROSION AND SEDIMENTATION CONTROL PRE-GRADING MEETING
- PHASE 1
 - JAN. 20, 2014 - INSTALL SILT FENCE, INLET FILTERS
 - JAN. 22, 2014 - REMOVE PAVEMENT, WALKS, CURB, LIGHTS
 - FEB. 3, 2014 - PLACE STABILIZED CONSTRUCTION ACCESS
 - FEB. 4, 2014 - GRADE SITE TO BOTTOM OF STONE & EXCAVATE FOR BUILDING
 - FEB. 10, 2014 - INSTALL BUILDING FOOTINGS AND START BUILDING CONSTRUCTION
 - FEB. 17, 2014 - PLACE CURB AND PAVEMENT
 - FEB. 24, 2014 - INSTALL LIGHTS, LANDSCAPING, SEED AND MULCH
 - MAR. 3, 2014 - REMOVE SEDIMENT FROM STORM WATER MANAGEMENT SYSTEM
 - MAR. 4, 2014 - REMOVE ALL TEMPORARY SOIL EROSION CONTROL MEASURES
- PHASE 2
 - MAR. 5, 2014 - INSTALL SILT FENCE, INLET FILTERS
 - MAR. 10, 2014 - REMOVE PAVEMENT, WALKS, CURB, LIGHTS
 - MAR. 17, 2014 - PLACE STABILIZED CONSTRUCTION ACCESS
 - MAR. 18, 2014 - GRADE SITE TO BOTTOM OF STONE & EXCAVATE FOR BUILDING
 - MAR. 24, 2014 - INSTALL BUILDING FOOTINGS AND START BUILDING CONSTRUCTION
 - MAR. 31, 2014 - PLACE CURB AND PAVEMENT
 - APR. 6, 2014 - INSTALL LIGHTS, LANDSCAPING, SEED AND MULCH
 - APR. 13, 2014 - REMOVE SEDIMENT FROM STORM WATER MANAGEMENT SYSTEM
 - APR. 14, 2014 - REMOVE ALL TEMPORARY SOIL EROSION CONTROL MEASURES
- PHASE 3
 - APR. 15, 2014 - INSTALL SILT FENCE, INLET FILTERS
 - APR. 16, 2014 - REMOVE PAVEMENT, WALKS, CURB, LIGHTS
 - APR. 28, 2014 - GRADE SITE TO BOTTOM OF STONE AND INSTALL LIVING WALL SYSTEM.
 - MAY 19, 2014 - PLACE CURB AND PAVEMENT
 - MAY 26, 2014 - INSTALL LIGHTS, LANDSCAPING, SEED AND MULCH
 - JUNE 2, 2014 - REMOVE SEDIMENT FROM STORM WATER MANAGEMENT SYSTEM
 - JUNE 3, 2014 - REMOVE ALL TEMPORARY SOIL EROSION CONTROL MEASURES

CONSTRUCTION SEQUENCE NOTES:

- HYDRANTS PROVIDING PROTECTION COVERAGE FOR THE BUILDINGS SHALL BE IN SERVICE AND APPROVED BY BOTH ENGINEERING AND FIRE DEPARTMENT BEFORE FIRE DEPARTMENT WILL SUPPORT PERMIT ISSUANCE FOR NEW CONSTRUCTION PHASE AND BEFORE COMBUSTIBLE MATERIAL ARE PLACED ON THE JOB SITE.
- STORAGE AREA FOR CONSTRUCTION MATERIALS SHALL NOT INTERFERE WITH FIRE/EMERGENCY SITE ACCESS.
- IF SITE ACCESS IS TO BE RESTRICTED DURING CONSTRUCTION, A KNOX BOX LOOK FOR THE GATE IS TO BE PROVIDED. ANY OTHER MEANS MUST BE APPROVED BY THE FIRE MARSHALL.

REVISED 10-22-2014

CLIENT LOCATION FOR	Architectural Alliance City of Ann Arbor Germain Ann Arbor	ENGINEER'S OPINION OF PROBABLE COSTS	DATE: 9-27-2013	JOB # 31667	Prepared By: Seth Gamer
ITEM No.	ITEM DESCRIPTION	ESTIMATED QUANTITIES	UNIT USED	UNIT PRICE	AMOUNT
Soil Erosion Controls					
1	Inlet Filters	12	EA	\$82.88	\$994.56
2	Silt Fence	2214	LF	\$1.40	\$3,099.60
3	Stabilized Construction Access	2	LS	\$585.00	\$1,170.00
4	Dust Emission Control (Sweeping)	2	LS	\$2,000.00	\$4,000.00
5	Earth Fill	3244	CY		
Total Cost					\$9,264.16
Protection of all exposed soil surfaces from erosion should work discontinue					
1	Restoration - includes topsoil distribution, mulch & seed	125873	SF	\$0.27	\$33,985.71
Total Cost					\$33,985.71
Phase 1					
73560 SF					\$19,861.20
Phase 2					
15450 SF					\$4,171.50
Phase 3					
36863 SF					\$9,953.01

CONSTRUCTION MAINTENANCE TASKS AND SCHEDULE									
GERMAIN OF ANN ARBOR CITY OF ANN ARBOR WASHTENAW COUNTY, MI									
Tasks	Collection System				Storm Water Management Basin				Scheduled Frequency
	Storm Sewer System	Catch Basin Sumps	Catch Basin Inlets	Ditches & Swales	Outlet Structure	Sedimentation Basin	Storm Detention Area	Emergency Overflow	
Inspect for Sediment Accumulation	X	X	X	X	X	X	X	X	Weekly
Removal of Sediment Accumulation	X	X							As Needed ^[1] & prior to Acceptance
Inspect for floatables and debris			X	X	X	X	X	X	Weekly
Removal of floatables and debris			X	X	X	X	X	X	As Needed & prior to Acceptance
Inspect for erosion				X	X	X	X	X	Weekly
Re-establish permanent vegetation on eroded slopes				X		X	X	X	As Needed & prior to Acceptance
Replacement of stone					X				As Needed & prior to Acceptance
Inspect during wet weather & after major storms	X	X	X	X	X	X	X	X	As Needed
Repair Storm Damage to System and Erosion Control	X	X	X	X	X	X	X	X	As Needed

The Contractor will be responsible for installation and maintenance during construction.
[1] As Needed means when sediment has accumulated to a maximum of one foot.

PERMANENT MAINTENANCE TASKS AND SCHEDULE									
GERMAIN OF ANN ARBOR CITY OF ANN ARBOR WASHTENAW COUNTY, MI									
Tasks	Collection System				Storm Water Management Basin				Scheduled Frequency
	Storm Sewer System	Catch Basin Sumps	Catch Basin Inlets	Ditches & Swales	Outlet Structure	Sedimentation Basin	Storm Detention Area	Emergency Overflow	
Inspect for Sediment Accumulation	X	X	X	X	X	X	X	X	Annually
Removal of Sediment Accumulation	X	X							As Needed ^[1]
Inspect for floatables and debris			X	X	X	X	X	X	Annually
Removal of floatables and debris			X	X	X	X	X	X	As Needed ^[1]
Inspect for erosion				X	X	X	X	X	Annually
Re-establish permanent vegetation on eroded slopes				X		X	X	X	As Needed
Replacement of stone					X				Every 3-5 years as Needed
Mowing				X		X	X	X	0-2 Times per year
Inspection comparing to as-built records after major storms by a Professional Engineer	X	X	X	X	X	X	X	X	Minimum Annually and As Needed
Repair Storm Damage to System and Permanent Erosion Control	X	X	X	X	X	X	X	X	As Needed
Keep records on site of all maintenance inspections, actions and costs									Annually

CAR GER MI ANN ARB L.L.C. will be responsible for maintenance after construction.
[1] As Needed means when sediment has accumulated to a maximum of one foot.

MAINTENANCE PLAN BUDGET		
GERMAIN OF ANN ARBOR CITY OF ANN ARBOR WASHTENAW COUNTY, MI		
Item No.	Description	Annual Cost
1	Annual Inspection for sediment accumulation	\$90.00
2	Removal of sediment accumulation every 2 years as needed	\$2,200.00
3	Inspect for floatables & debris annually and after major storms	\$120.00
4	Removal of floatables and debris annually and after major storms	\$250.00
5	Inspect for erosion	\$120.00
6	Re-establish permanent vegetation on eroded slopes	\$200.00
7	Replacement of stone	\$250.00
8	Mowing	\$400.00
9	Wet Weather Inspections and Report by Professional Engineer	\$180.00
10	Records Maintenance	\$90.00
Estimated Annual Maintenance Cost		\$3,900.00

REVISED 10-22-2013

PORTABLE CONCRETE WASHOUT CONTAINER

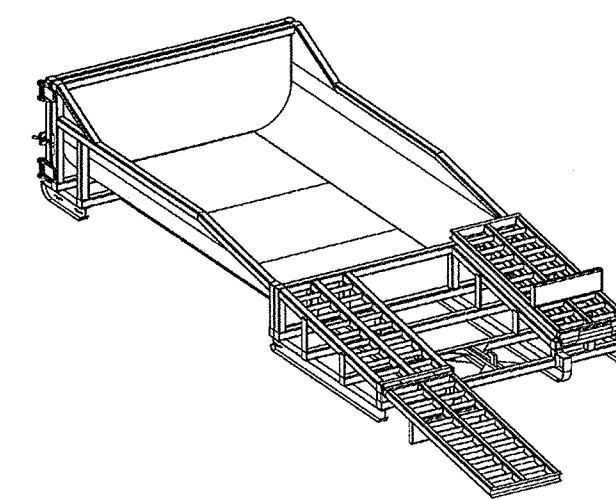

PO Box 2604
Carmichael, CA 95609
Phone: 1.877.232.7468
Fax: 1.916.244.0403
info@concretewashout.com
www.concretewashout.com
Patent Pending

DESCRIPTION
A portable, self-contained and watertight container affixed with ramps that controls, captures and contains caustic concrete wastewater and washout material.

PURPOSE & OBJECTIVE
Allows trade personnel to easily washout concrete trucks, pumps and other equipment associated with cement on site and allows easy off site recycling of the same concrete materials and wastewater.

APPLICATION
Construction projects where concrete, stucco, mortar, grout and cement are used as a construction material or where cementitious wastewater is created.

MAINTENANCE
Inspect and clean out when 3/4 full, not allowing the container to overflow.
Inspect wastewater level and request a vacuum if needed.
Inspect subcontractors to ensure that proper housekeeping measures are employed when washing out equipment.

SPECIFICATIONS
The container must be portable and temporary, watertight, equipped with ramps and have a holding capacity to accept washout from approximately 350 yards of poured concrete. A vacuum service must accompany washout container and be used by site superintendent as needed. A rampless container may be used in conjunction with a ramped container or by itself if a concrete pump is not needed. The washwater must be disposed of or treated and recycled in an environmentally safe manner and in accordance with federal, state or local regulatory guidelines.

TARGETED POLLUTANTS
Caustic wastewater (high pH level near 12 units)
Suspended solids
Assorted Metals; Chromium VI, Nickel, Sulfate, Potassium, Magnesium and Calcium Compounds

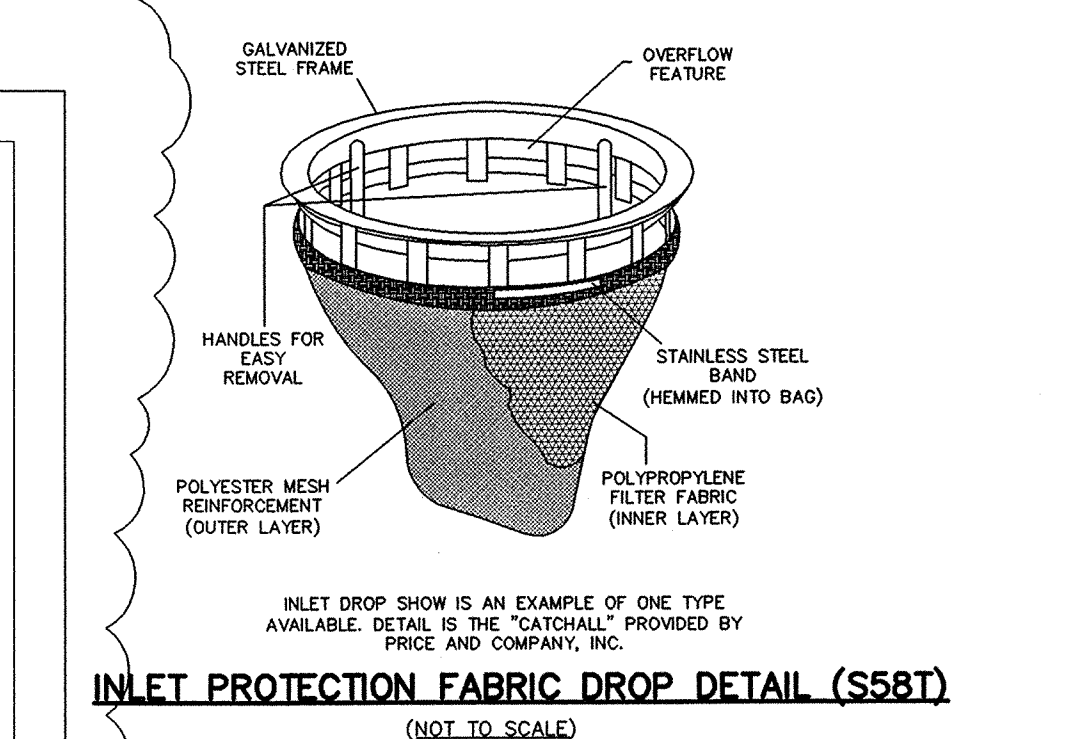
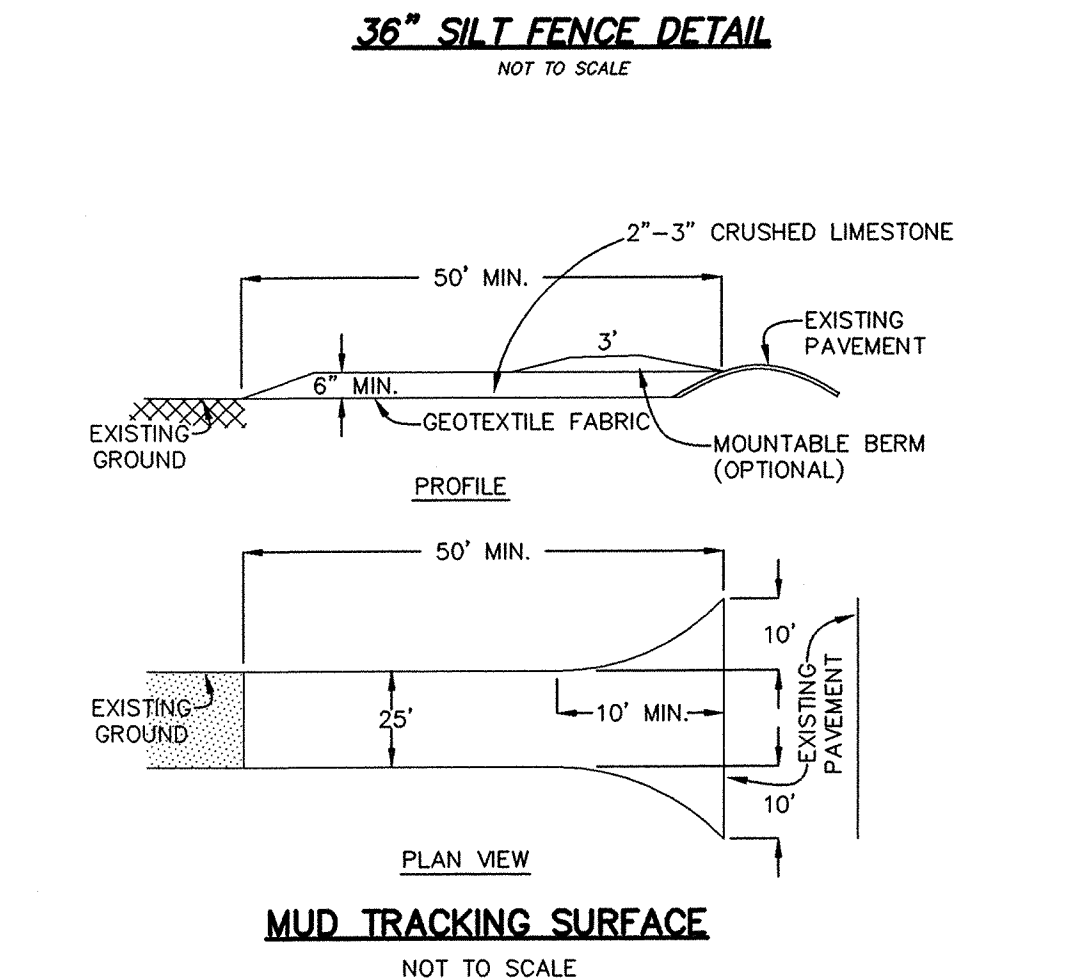
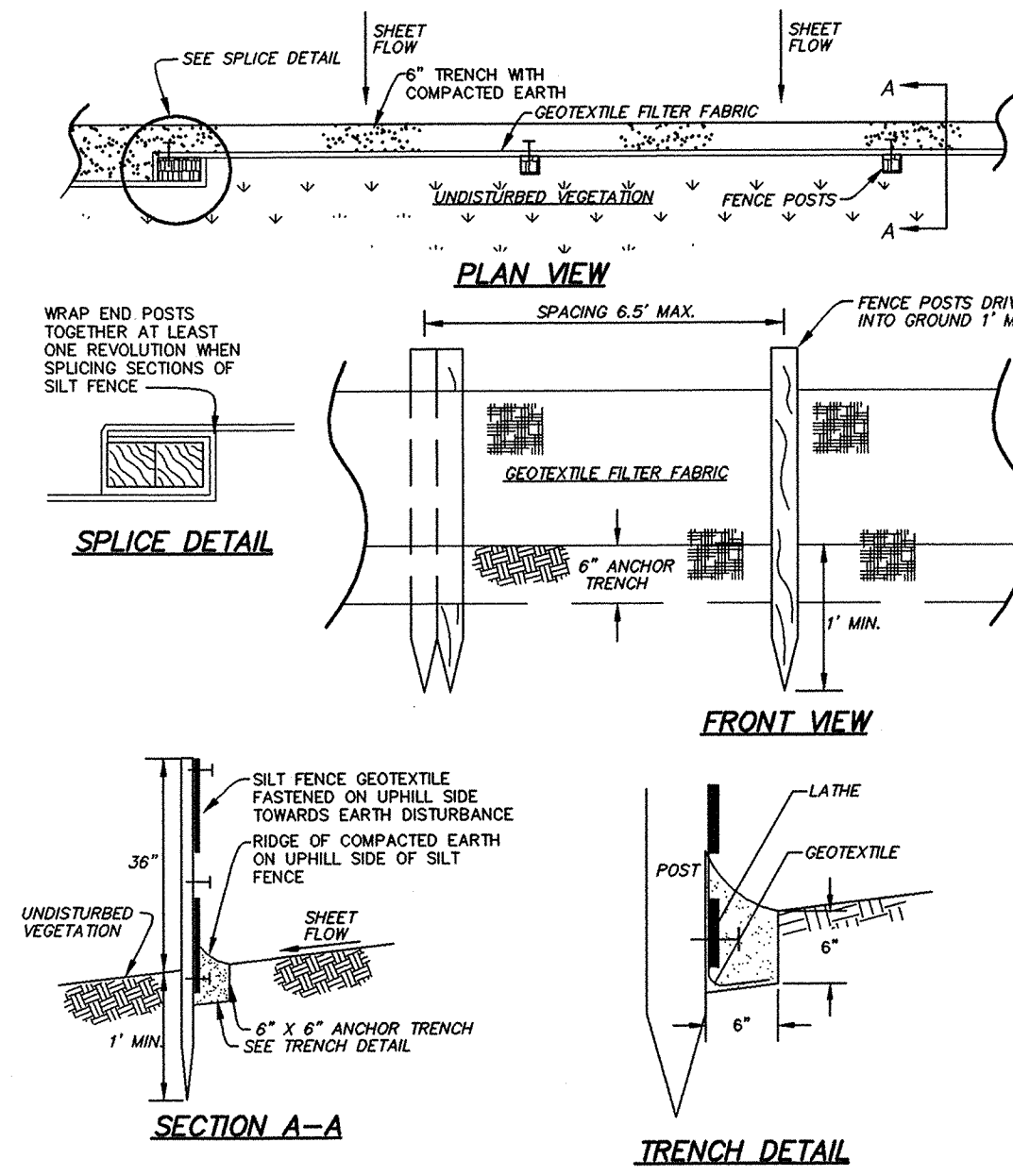

THE UNDERGROUND UTILITIES SHOWN HAVE BEEN LOCATED FROM FIELD SURVEY INFORMATION AND EXISTING RECORDS. THE SURVEYOR MAKES NO GUARANTEES THAT THE UNDERGROUND UTILITIES SHOWN COMPARE TO THE ACTUAL UTILITIES IN THE AREA, EITHER IN SERVICE OR ABANDONED. THE SURVEYOR DOES NOT WARRANT THAT THE UTILITIES SHOWN ARE ACCURATELY LOCATED AS SHOWN ON THIS PLAN. THE SURVEYOR HAS NOT PHYSICALLY LOCATED THE UNDERGROUND UTILITIES.

COPYRIGHT © 2013 WASHTENAW ENGINEERING COMPANY, INC. NO REPRODUCTION SHALL BE MADE WITHOUT PRIOR WRITTEN CONSENT OF WASHTENAW ENGINEERING COMPANY, INC.

THE OWNER SHALL NOT USE OR REPRODUCE ANY OTHER PERSON TO USE THE DRAWINGS, SPECIFICATIONS, ELECTRONIC DATA, AND OTHER INSTRUMENTS OF SERVICE ON OTHER PROJECTS, FOR ADDITION TO THIS PROJECT OR FOR COMPLETION OF THE PROJECT. ANY OTHERS SO LONG AS WASHTENAW ENGINEERING COMPANY (WECO) IS NOT ADVISED TO BE IN DEFAULT UNDER THIS AGREEMENT. THE OWNER SHALL INDEMNIFY AND HOLD HARMLESS WECO, WECO'S CONSULTANTS AND EMPLOYEES OF ANY OF THEM FROM AND AGAINST CLAIMS, DAMAGES, LOSSES AND EXPENSES, INCLUDING BUT NOT LIMITED TO ATTORNEY'S FEES, ARISING OUT OF UNAUTHORIZED REUSE OF DRAWINGS, SPECIFICATIONS, ELECTRONIC DATA OR OTHER INSTRUMENTS OF SERVICE.

- LEGEND**
- Light Pole
 - Spot Elev.
 - Post
 - Gate Valve
 - Hydrant
 - Top of Curb
 - Top of Wall
 - Manhole
 - Catchbasin
 - End Section
 - Gravel
 - Fence
 - Concrete
 - Asphalt
 - Existing Storm
 - Existing Sanitary
 - Existing Water
 - Existing Gas
 - Existing Electric
 - Existing Telephone

BENCHMARK
BM1=STEAMER VALVE ON HYDRANT IN FRONT OF 2575 S. STATE ST., ELEV=891.31
BM2=CITY OF ANN ARBOR NO. 0113 NORTH OF DRIVE TO 2555 S. STATE ST. AND ON EAST SIDE OF STATE ST., ELEV=887.49

REVISIONS - 10-22-2013 PER CITY, 10-28-2013 PER CITY, 11-5-2013 PER CITY

SCALE
NO SCALE

PREPARED BY: Robert J. Wanty, P.E., MICH No. 28666

811
Know what's below.
Call before you dig.

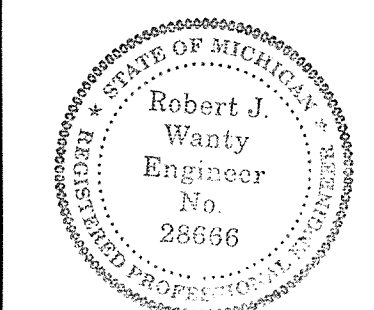

CIVIL ENGINEERS
PLANNERS • SURVEYORS
LANDSCAPE ARCHITECTS
3528 W. LIBERTY RD
SUITE 400
ANN ARBOR, MI 48106
TEL: 734-761-8800
FAX: 734-761-8830
WWW.WASHTENAWENGINEERING.COM

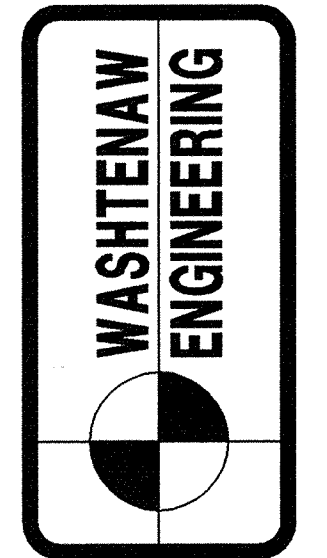

ARCHITECTURAL ALLIANCE
165 NORTH FIFTH ST
COLUMBUS, OH 43215
TEL: 614-469-7500
FAX: 614-469-0500
www.aacall.com

SOIL EROSION CONTROL NOTES AND DETAILS

GERMAIN OF ANN ARBOR CAMPUS IMPROVEMENTS

SECTION 4 TOWN 3 SOUTH RANGE 6 EAST
CITY OF ANN ARBOR
WASHTENAW COUNTY • MICHIGAN
JOB NO. 31667
DWG NO. 667-7-866C
FIELD BOOK 556, 649
FILE NO. 10027

THE UNDERGROUND UTILITIES SHOWN HAVE BEEN LOCATED FROM FIELD SURVEY INFORMATION AND EXISTING RECORDS. THE SURVEYOR MAKES NO WARRANTY AS TO THE ACCURACY OF THE INFORMATION SHOWN. THE SURVEYOR DOES NOT WARRANT THAT THE UNDERGROUND UTILITIES SHOWN ARE IN THE EXACT LOCATION INDICATED. ALTHOUGH THE SURVEYOR HAS MADE EVERY EFFORT TO LOCATE THE UTILITIES AS ACCURATELY AS POSSIBLE FROM INFORMATION AVAILABLE, THE SURVEYOR HAS NO PHYSICAL LOCATED THE UNDERGROUND UTILITIES.

THE OWNER SHALL NOT USE OR AUTHORIZE ANY OTHER PERSON TO USE THE DRAWINGS, SPECIFICATIONS, ELECTRONIC DATA AND ANY INFORMATION CONTAINED HEREIN FOR ANY OTHER PROJECT OR FOR ANY OTHER PURPOSE WITHOUT THE WRITTEN CONSENT OF WASHTENAW ENGINEERING COMPANY, INC. NO REPRODUCTION SHALL BE MADE WITHOUT PRIOR WRITTEN CONSENT OF WASHTENAW ENGINEERING COMPANY, INC.

THE OWNER SHALL NOT USE OR AUTHORIZE ANY OTHER PERSON TO USE THE DRAWINGS, SPECIFICATIONS, ELECTRONIC DATA AND ANY INFORMATION CONTAINED HEREIN FOR ANY OTHER PROJECT OR FOR ANY OTHER PURPOSE WITHOUT THE WRITTEN CONSENT OF WASHTENAW ENGINEERING COMPANY, INC. NO REPRODUCTION SHALL BE MADE WITHOUT PRIOR WRITTEN CONSENT OF WASHTENAW ENGINEERING COMPANY, INC.

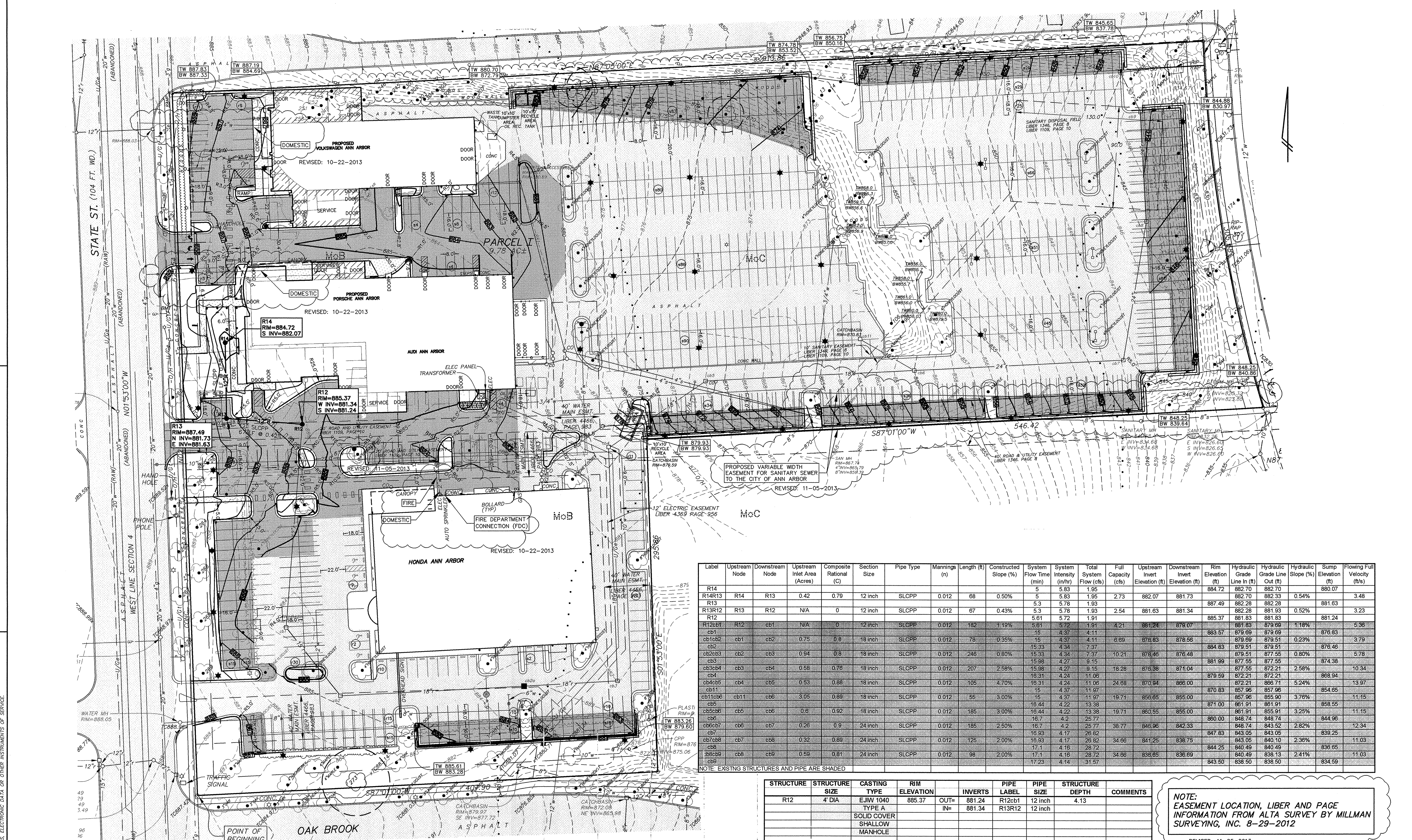

SANITARY SEWER FLOW ESTIMATE:

INCREASE (GSF)	SQ. FT	GAL/DAY/SQ. FT.	CPD
NEW/USED AUTOMOBILE SALES	5263	0.03(DRY STORE)	157.89
NEW/USED AUTOMOBILE REPAIR	4361	0.04(GEN. INDUSTRY)	174.44
			332.33

FOOTING DRAIN DISCONNECTS (FDD):

PEAK FLOW 332.33 x 4 x 1.2 = 1,595.184 gal/day (1.1 gpm)
 1.1 / 4 = 0.28 use (0 FDD)

STORM SEWER NOTE:

- SMOOTH LINED CORRUGATED PLASTIC PIPE (SLCPP) SHALL BE ADS N-12 OR EQUIVALENT. CONTRACTOR TO VERIFY LOCATION AND DEPTH OF EXISTING STORM SEWER PRIOR TO NEW STORM SEWER CONSTRUCTION.

FIRE PROTECTION NOTES:

- THERE ARE NO FIRE WALLS INSIDE ANY OF THE EXISTING OR PROPOSED BUILDINGS.
- FLOW REQUIREMENTS SHALL COMPLY WITH INTERNATIONAL FIRE CODE (IFC) 2009, APPENDIX B, TABLE B105.1.
- FIRE PROTECTION ALARM AND DETECTION SYSTEMS SHALL COMPLY WITH CITY STANDARDS AS WELL AS NFPA 72, 2007 EDITION.
- A KNOX BOX SHALL BE MOUNTED FOR EMERGENCY ACCESS TO THE BUILDING AND THE FIRE SUPPRESSION SYSTEM CONTROL ROOM.

NOTE: EXISTING STRUCTURES AND PIPE ARE SHADED

Label	Upstream Node	Downstream Node	Upstream Inlet Area (Acres)	Composite Rational (C)	Section Size	Pipe Type	Manning (n)	Length (ft)	Constructed Slope (%)	System Flow Time (min)	System Intensity (in/hr)	Total System Flow (cfs)	Full Capacity (cfs)	Upstream Invert Elevation (ft)	Downstream Invert Elevation (ft)	Rim Elevation (ft)	Hydraulic Grade Line In (ft)	Hydraulic Grade Line Out (ft)	Hydraulic Slope (%)	Sump Elevation (ft)	Flowing Full Velocity (ft/s)
R14	R14	R13	0.42	0.79	12 inch	SLCPP	0.012	68	0.50%	5	5.83	1.95	2.73	882.07	881.73	884.72	882.70	882.70	0.54%	880.07	3.48
R13	R13	R12	N/A	0	12 inch	SLCPP	0.012	67	0.43%	5.3	5.78	1.93	2.54	881.63	881.34	887.49	882.28	882.28	0.52%	881.63	3.23
R12	R12	cb1	N/A	0	12 inch	SLCPP	0.012	182	1.18%	5.61	5.72	1.91	4.21	881.24	879.07	885.37	881.83	881.83	1.18%	881.24	5.36
cb1	cb1	cb2	0.75	0.8	18 inch	SLCPP	0.012	78	0.35%	15	4.37	4.11	6.69	878.83	878.56	884.83	879.69	879.69	0.23%	878.83	3.79
cb2	cb2	cb3	0.94	0.8	18 inch	SLCPP	0.012	246	0.80%	15.33	4.34	7.37	10.21	878.46	878.48	884.83	879.51	879.51	0.80%	878.46	5.78
cb3	cb3	cb4	0.58	0.76	18 inch	SLCPP	0.012	207	2.58%	15.98	4.27	9.15	16.28	878.36	871.04	881.89	877.55	872.21	2.58%	874.38	10.34
cb4	cb4	cb5	0.53	0.88	18 inch	SLCPP	0.012	105	4.70%	16.31	4.24	11.05	24.68	878.54	866.00	879.59	872.21	872.21	5.24%	868.94	13.97
cb5	cb5	cb6	3.05	0.89	18 inch	SLCPP	0.012	55	3.00%	15	4.37	11.97	19.71	856.65	855.00	870.83	857.96	857.96	3.76%	854.65	11.15
cb6	cb6	cb7	0.6	0.92	18 inch	SLCPP	0.012	185	3.00%	16.44	4.22	13.38	19.71	855.55	855.00	871.00	856.91	856.91	3.25%	854.96	11.15
cb7	cb7	cb8	0.26	0.9	24 inch	SLCPP	0.012	185	2.50%	16.7	4.2	25.77	38.77	845.96	842.33	860.00	848.74	843.52	2.82%	844.96	12.34
cb8	cb8	cb9	0.32	0.89	24 inch	SLCPP	0.012	125	2.00%	16.93	4.17	26.82	34.66	841.25	838.75	847.83	843.05	840.10	2.36%	838.25	11.03
cb9	cb9	cb8	0.59	0.81	24 inch	SLCPP	0.012	98	2.00%	17.1	4.16	28.72	34.66	838.65	836.69	844.25	840.49	838.13	2.41%	836.65	11.03
cb8	cb8	cb9	0.59	0.81	24 inch	SLCPP	0.012	98	2.00%	17.23	4.14	31.57				843.50	838.50			834.59	11.03

STRUCTURE	STRUCTURE SIZE	CASTING TYPE	RIM ELEVATION	INVERTS	PIPE LABEL	PIPE SIZE	STRUCTURE DEPTH	COMMENTS
R12	4' DIA	EJW 1040	885.37	OUT= 881.24 IN= 881.34	R12cb1 R13R12	12 inch	4.13	
		SOLID COVER						
		SHALLOW MANHOLE						
R13	4' DIA	EJW 1040	887.49	OUT= 881.63 IN= 881.73	R13R12 R14R13	12 inch	5.86	
		SOLID COVER						
		MANHOLE						
R14	2' DIA	EJW 1040	884.72	OUT= 882.07	R14R13	12 inch	4.65	2' SUMP
		TYPE 02 BEEHIVE						
		YARD INLET						

NOTE: EASEMENT LOCATION, LIBER AND PAGE INFORMATION FROM ALTA SURVEY BY MILLMAN SURVEYING, INC. 8-29-2012

REVISED: 11-05-2013

LEGEND

○ = LIGHT POLE	● = SPOT ELEV.	— = TOP OF CURB	— = GRAVEL	— = EXISTING STORM
○ = UTILITY POLE	○ = GATE VALVE	— = TOP OF WALL	— = FENCE	— = EXISTING SANITARY
○ = GUY ANCHOR	○ = HYDRANT	○ = MANHOLE	— = CONCRETE	— = EXISTING WATER
		○ = CATCHBASIN	— = ASPHALT	— = EXISTING GAS
		— = END SECTION		— = EXISTING ELECTRIC
				— = EXISTING TELEPHONE

BENCHMARK
 BM1=STEAMER VALVE ON HYDRANT IN FRONT OF 2575 S. STATE ST., ELEV=891.31.
 BM2=CITY OF ANN ARBOR NO. 0113 NORTH OF DRIVE TO 2555 S. STATE ST. AND ON EAST SIDE OF STATE ST., ELEV=887.49.

REVISIONS - 10-22-2013 PER CITY, 10-28-2013 PER CITY, 11-5-2013 PER CITY

SCALE
 0 20 40 80
 SCALE: 1"=40'

PREPARED BY: *Robert J. Wanty*
 ROBERT J. WANTY P.E., MICH No. 28666



STATE OF MICHIGAN
 Robert J. Wanty
 Engineer No. 28666

CLIENT
 ARCHITECTURAL ALLIANCE
 165 NORTH FIFTH ST
 COLUMBUS, OH 43215
 TEL: 614-469-7500
 FAX: 614-469-7500
 www.archall.com

PROJECT
 SECTION 4 TOWN 3 SOUTH RANGE 6 EAST
 CITY OF ANN ARBOR
 WASHTEANAW COUNTY - MICHIGAN
 JOB NO. 31667
 DWG NO.
 FIELD BOOK 556, 649
 FILE NO. 10027

SHEET
 8

WASHTENAW ENGINEERING
 CIVIL ENGINEERS • SURVEYORS
 LANDSCAPE ARCHITECTS
 3526 W. LIBERTY RD
 ANN ARBOR, MI 48103
 TEL: 734-761-8800
 FAX: 734-761-8800
 WWW.WASHTENAWENGINEERING.COM

THE UNDERGROUND UTILITIES SHOWN HAVE BEEN LOCATED FROM FIELD SURVEY INFORMATION AND EXISTING RECORDS. THE SURVEYOR MAKES NO WARRANTY AS TO THE ACCURACY OF THE INFORMATION SHOWN. THE SURVEYOR FURTHER DOES NOT WARRANT THAT THE UNDERGROUND UTILITIES SHOWN ARE IN THE EXACT LOCATION INDICATED, ALTHOUGH THE SURVEYOR DOES CERTIFY THAT THEY ARE LOCATED AS ACCURATELY AS POSSIBLE FROM INFORMATION AVAILABLE. THE SURVEYOR HAS NOT PHYSICALLY LOCATED THE UNDERGROUND UTILITIES.

THE OWNER SHALL NOT USE OR AUTHORIZE ANY OTHER PERSON TO USE THE DRAWINGS, SPECIFICATIONS, ELECTRONIC DATA AND OTHER INSTRUMENTS OF SERVICE ON OTHER PROJECTS, FOR ADDITIONS TO THIS PROJECT OR FOR COMPLETION OF THE PROJECT BY OTHER INSTRUMENTS OF SERVICE. THE SURVEYOR'S LIABILITY IS LIMITED TO THE PROFESSIONAL LIABILITY TO WHICH HE OR SHE IS SUBJECT BY LAW. THE SURVEYOR SHALL NOT BE RESPONSIBLE FOR THE ACTIONS AND OMISSIONS OF ANY OTHER PERSONS OR FOR THE ACTIONS AND OMISSIONS OF ANY OTHER INSTRUMENTS OF SERVICE. THE SURVEYOR SHALL NOT BE RESPONSIBLE FOR THE ACTIONS AND OMISSIONS OF ANY OTHER PERSONS OR FOR THE ACTIONS AND OMISSIONS OF ANY OTHER INSTRUMENTS OF SERVICE.

REVISIONS - 10-22-2013 PER CITY, 10-28-2013 PER CITY, 11-5-2013 PER CITY

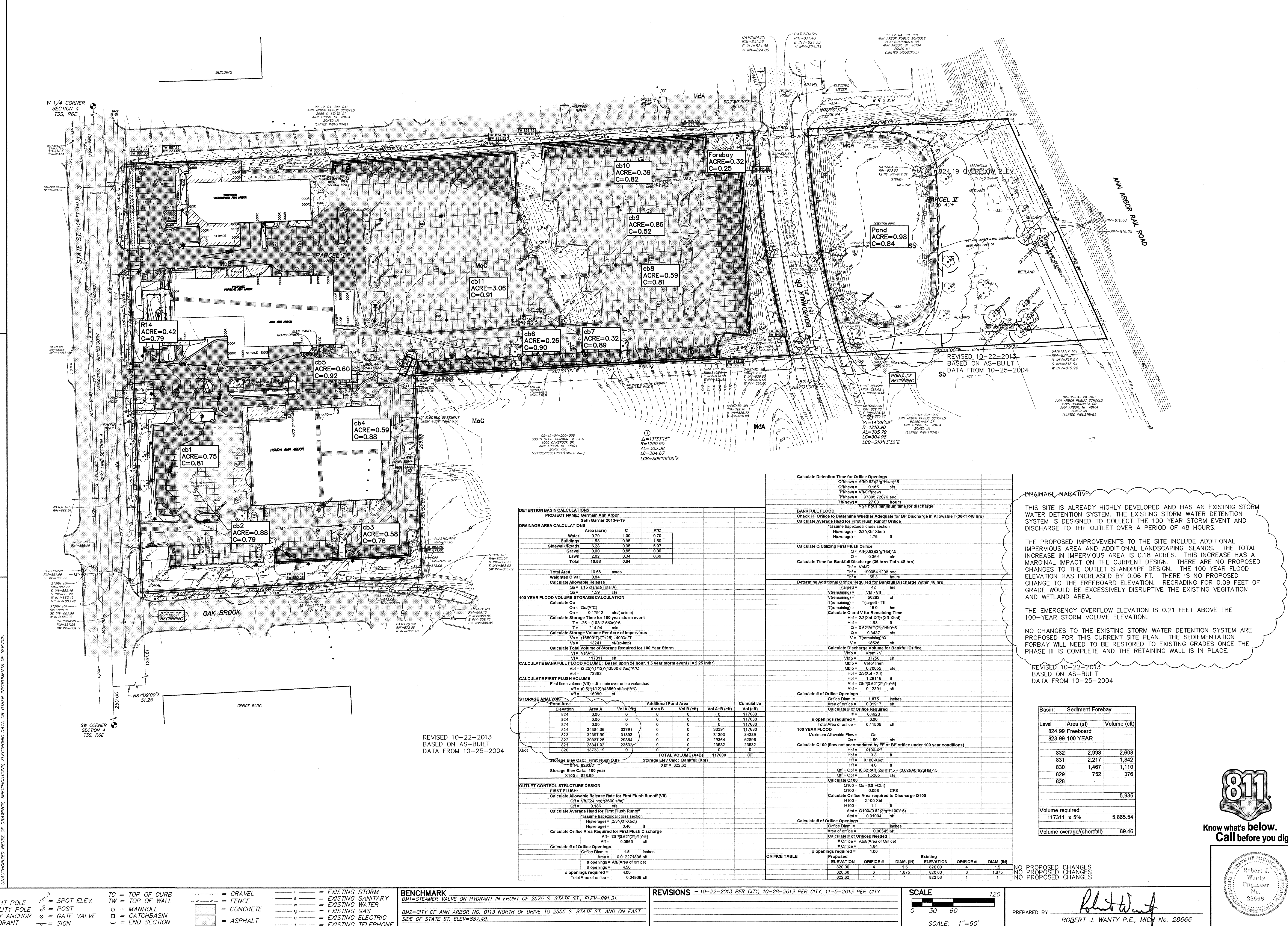

DETENTION BASIN CALCULATIONS
PROJECT NAME: Germain Ann Arbor
Date: 2013-08-19

DRAINAGE AREA CALCULATIONS

Area (acre)	C	A/C
Water	0.70	1.00
Buildings	1.58	0.95
Sidewalk/Roads	6.28	0.95
Gravel	0.00	0.85
Lawn	2.22	0.24
Total	10.58	0.84

100 YEAR FLOOD VOLUME STORAGE CALCULATION

Calculate Q₀ = Q_a(A/C)
Q₀ = 0.17912 cfs @ (100-yr event)
T = 25 + (10312.5/Q₀)^{0.5}
T = 214.84 min
Calculate Storage Volume Per Acre of Impervious
V_s = (18500)(T)(1.25) - 40(Q₀T)^{0.5}
V_s = 13241 cfs @ (100-yr event)
Calculate Total Volume of Storage Required for 100 Year Storm
V_T = V_sA/C
V_T = 117311 cft

Calculate Bankfull Flood Volume: Based upon 24 hour, 1.5 year storm event (I = 2.26 in/hr)
V_B = (2.25)(1/12)(43560 sf/acre)A/C
V_B = 72362 cft

Calculate First Flush Volume:
First flush volume (V_{FF}) = 5 in rain over entire watershed
V_{FF} = (0.5)(1/12)(43560 sf/acre)A/C
V_{FF} = 16030 cft

STORAGE ANALYSIS

Elevation	Pond Area		Additional Pond Area		Cumulative	
	Area A	Vol A (cft)	Area B	Vol B (cft)	Vol A+B (cft)	Vol (cft)
824	0.00	0	0	0	0	117680
824	0.00	0	0	0	0	117680
824	0.00	0	0	0	0	117680
824	34384.36	33391	0	0	33391	117680
823	23293.99	31393	0	0	31393	84289
822	30387.25	29364	0	0	29364	52896
821	28341.02	23522	0	0	23522	23522
820	18723.19	0	0	0	0	0

OUTLET CONTROL STRUCTURE DESIGN
FIRST FLUSH:
Calculate Allowable Release Rate for First Flush Runoff (V_{FF})
Q_{FF} = V_{FF}(24 hrs)(3600 s/hr)
Q_{FF} = 0.189 cfs
Calculate Average Head for First Flush Runoff
H_{avg} = 2/3(H₁-H₂)
H_{avg} = 0.46 ft
Calculate Orifice Area Required for First Flush Discharge
A_{FF} = Q_{FF}(0.62)(2)(gH_{avg})^{-0.5}
A_{FF} = 0.2853 sq ft
Calculate # of Orifice Openings
Orifice Diam. = 1.5 inches
Area = 0.01271936 sq ft
openings = A_{FF}/Area of orifice
openings = 4.50
openings required = 4.50
Total Area of orifice = 0.04909 sq ft

Calculate Detention Time for Orifice Openings
Q_{ff(new)} = A_{ff}(0.62)(2)(gH_{avg})^{0.5}
Q_{ff(new)} = 0.189 cfs
T_{ff(new)} = V_{FF}/Q_{ff(new)}
T_{ff(new)} = 97395.72078 sec
T_{ff(new)} = 27.05492272 hours
> 24 hour minimum time for discharge

BANKFULL FLOOD
Check FF Orifice to Determine Whether Adequate for BF Discharge in Allowable (T_{FF} < 48 hrs)
Calculate Average Head for First Flush Runoff Orifice
Assume trapezoidal cross section
H_{avg} = 2/3(H₁-H₂)
H_{avg} = 1.75 ft
Calculate Q Utilizing First Flush Orifice
Q = A_{ff}(0.62)(2)(gH_{avg})^{0.5}
Q = 0.284 cfs
Calculate Time for Bankfull Discharge (36 hrs < T_B < 48 hrs)
T_B = V_B/Q
T_B = 19954.1208 sec
T_B = 5.53 hours

Determine Additional Orifice Required for Bankfull Discharge Within 48 hrs
V_{rem} = V_B - V_{FF}
V_{rem} = 52323 cft
T_{rem} = V_{rem}/Q_{FF}
T_{rem} = 18.0 hrs
Calculate Q and V for Remaining Time
Q = 0.62(A_{ff})(2)(gH_{avg})^{0.5}
Q = 0.2437 cfs
V = T_{rem}Q
V = 16526 cft
Calculate Discharge Volume for Bankfull Orifice
V_{ffo} = V_{rem} - V
V_{ffo} = 3756 cft
Q_{ffo} = V_{ffo}/T_{rem}
Q_{ffo} = 0.20955 cfs
H_{ffo} = 23007 - 200
H_{ffo} = 12916 ft
A_{ffo} = Q_{ffo}(0.62)(2)(gH_{ffo})^{-0.5}
A_{ffo} = 0.12391 sq ft

Calculate # of Orifice Openings
Orifice Diam. = 1.875 inches
Area of orifice = 0.01917 sq ft
Calculate # of Orifice Required
openings required = 6.4623
Total Area of orifice = 0.11505 sq ft

100 YEAR FLOOD
Maximum Allowable Flow = Q_a
Q_a = 1.59 cfs
Calculate Q100 (flow not accommodated by FF or BF orifice under 100 year conditions)
H_{ff} = X100-X_{ff}
H_{ff} = 3.3 ft
H_{ff} = X100-X_{ffo}
H_{ff} = 4.0 ft
Q_{ff} + Q_{ffo} = (0.62)(A_{ff})(2)(gH_{ff})^{0.5} + (0.62)(A_{ffo})(2)(gH_{ff})^{0.5}
Q_{ff} + Q_{ffo} = 1.5285 cfs
Calculate Q100
Q100 = Q_a - (Q_{ff} + Q_{ffo})
Q100 = 0.0655 cfs
Calculate Orifice Area required to Discharge Q100
H100 = X100-X_{ff}
H100 = 1.4 ft
A₁₀₀ = Q100(0.62)(2)(gH100)^{-0.5}
A₁₀₀ = 0.01024 sq ft

Calculate # of Orifice Openings
Orifice Diam. = 1 inches
Area of orifice = 0.00545 sq ft
Calculate # of Orifices Needed
Orifice = A₁₀₀/Area of Orifice
Orifice = 1.84
openings required = 1.00

ORIFICE TABLE

ELEVATION	ORIFICE #	DIAM. (IN)	EXISTING ELEVATION	ORIFICE #	DIAM. (IN)
820.00	4	1.5	820.00	4	1.5
820.68	6	1.875	820.60	6	1.875
822.62	1	1	822.53	1	1

DRAINAGE NARRATIVE:
THIS SITE IS ALREADY HIGHLY DEVELOPED AND HAS AN EXISTING STORM WATER DETENTION SYSTEM. THE EXISTING STORM WATER DETENTION SYSTEM IS DESIGNED TO COLLECT THE 100 YEAR STORM EVENT AND DISCHARGE TO THE OUTLET OVER A PERIOD OF 48 HOURS.

THE PROPOSED IMPROVEMENTS TO THE SITE INCLUDE ADDITIONAL IMPERVIOUS AREA AND ADDITIONAL LANDSCAPING ISLANDS. THE TOTAL INCREASE IN IMPERVIOUS AREA IS 0.18 ACRES. THIS INCREASE HAS A MARGINAL IMPACT ON THE CURRENT DESIGN. THERE ARE NO PROPOSED CHANGES TO THE OUTLET STANDPIPE DESIGN. THE 100 YEAR FLOOD ELEVATION HAS INCREASED BY 0.06 FT. THERE IS NO PROPOSED CHANGE TO THE FREEBOARD ELEVATION. REGRADING FOR 0.09 FEET OF GRADE WOULD BE EXCESSIVELY DISRUPTIVE TO THE EXISTING VEGETATION AND WETLAND AREA.

THE EMERGENCY OVERFLOW ELEVATION IS 0.21 FEET ABOVE THE 100-YEAR STORM VOLUME ELEVATION.

NO CHANGES TO THE EXISTING STORM WATER DETENTION SYSTEM ARE PROPOSED FOR THIS CURRENT SITE PLAN. THE SEDIMENTATION FORBAY WILL NEED TO BE RESTORED TO EXISTING GRADES ONCE THE PHASE III IS COMPLETE AND THE RETAINING WALL IS IN PLACE.

REVISED 10-22-2013
BASED ON AS-BUILT
DATA FROM 10-25-2004

Basin: Sediment Forebay

Level	Area (sf)	Volume (cft)
824.99 Freeboard		
823.99 100 YEAR		
832	2,998	2,608
831	2,217	1,842
830	1,467	1,110
828	752	376
		5,935
Volume required:	117311 x 5%	5,865.54
Volume overage/(shortfall)		69.46

811
Know what's below.
Call before you dig.

- LEGEND**
- = LIGHT POLE
 - = SPOT ELEV.
 - = POST
 - = GUY ANCHOR
 - = GATE VALVE
 - = SIGN
 - = TOP OF CURB
 - = TOP OF WALL
 - = MANHOLE
 - = CATCHBASIN
 - = END SECTION
 - = EXISTING STORM
 - = EXISTING WATER
 - = EXISTING GAS
 - = EXISTING ELECTRIC
 - = EXISTING TELEPHONE
 - = GRAVEL
 - = FENCE
 - = CONCRETE
 - = ASPHALT

BENCHMARK
BM1=STEAMER VALVE ON HYDRANT IN FRONT OF 2575 S. STATE ST., ELEV.=891.31.
BM2=CITY OF ANN ARBOR NO. 0113 NORTH OF DRIVE TO 2555 S. STATE ST. AND ON EAST SIDE OF STATE ST. ELEV.=887.48.

REVISIONS - 10-22-2013 PER CITY, 10-28-2013 PER CITY, 11-5-2013 PER CITY

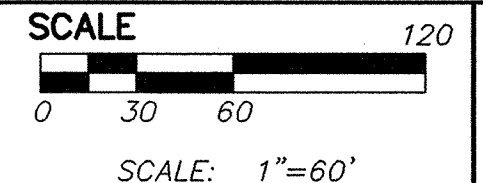

NO PROPOSED CHANGES
NO PROPOSED CHANGES
NO PROPOSED CHANGES

PREPARED BY: *Robert J. Wanty*
ROBERT J. WANTY P.E., MICH. No. 28666

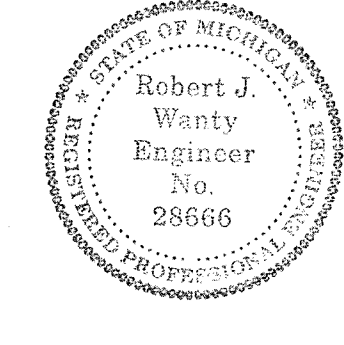

WASHTENAW ENGINEERING

CIVIL ENGINEERS
PLANNERS & SURVEYORS
LANDSCAPE ARCHITECTS

3526 W. LIBERTY RD.
ANN ARBOR, MI 48103
TEL 734-761-8800
FAX 734-761-8800
WWW.WASHTENAWENGINEERING.COM

ARCHITECTURAL ALLIANCE
165 NORTH FIFTH ST
COLUMBUS, OH 43215
TEL 614-469-7500
FAX 614-469-0300
WWW.CCRAI.COM

DRAINAGE AREA PLAN AND CALCULATIONS

GERMAIN OF ANN ARBOR CAMPUS IMPROVEMENTS

SECTION 4 TOWN 3 SOUTH RANGE 6 EAST
CITY OF ANN ARBOR
WASHTENAW COUNTY - MICHIGAN
JOB NO. 31667
DATE 9-30-13
DWS NO. 667-8-drn
FIELD BOOK 556, 649
FILE NO. 10227

9 SHEET

THE OWNER SHALL NOT USE OR AUTHORIZE ANY OTHER PERSON TO USE THE DRAWINGS, SPECIFICATIONS, ELECTRONIC DATA AND BY REUSE WITHOUT THE PROFESSIONAL INVOLVEMENT OF THE ENGINEER. THE ENGINEER'S LIABILITY IS LIMITED TO THE PROFESSIONAL SERVICE PROVIDED AND DOES NOT INCLUDE CLAIMS, DAMAGES, LOSSES AND EXPENSES, INCLUDING BUT NOT LIMITED TO ATTORNEY'S FEES, ARISING OUT OF UNAUTHORIZED REUSE OF DRAWINGS, SPECIFICATIONS, ELECTRONIC DATA OR OTHER INSTRUMENTS OF SERVICE.

THE UNDERGROUND UTILITIES SHOWN HAVE BEEN LOCATED FROM FIELD SURVEY INFORMATION AND EXISTING RECORDS. THE SURVEYORS MAKE NO REPRESENTATION AS TO THE ACCURACY OF THE INFORMATION PROVIDED AND THE SURVEYOR DOES NOT WARRANT THAT THE UNDERGROUND UTILITIES SHOWN ARE IN THE EXACT LOCATION INDICATED. ALTHOUGH NOT PHYSICALLY LOCATED, THE UNDERGROUND UTILITIES ARE SHOWN AS ACCURATELY AS POSSIBLE FROM INFORMATION AVAILABLE. THE SURVEYOR HAS NOT PHYSICALLY LOCATED THE UNDERGROUND UTILITIES.

COPYRIGHT © 2013 WASHTENAW ENGINEERING COMPANY, INC. NO REPRODUCTION SHALL BE MADE WITHOUT PRIOR WRITTEN CONSENT OF WASHTENAW ENGINEERING COMPANY, INC.

NOTES:
 1. A VARIANCE WAS GRANTED IN 1976 FOR A 24 INCH TALL SCREEN AND 5 WIDE LANDSCAPE BUFFER AT STATE STREET IN FRONT OF THE NORTHERNMOST (VOLKSWAGEN) BUILDING
 2. A REQUEST FOR LANDSCAPE MODIFICATION IS PART OF THIS APPLICATION FOR INTERIOR LANDSCAPING IN THE LARGE INTERIOR ISLAND.

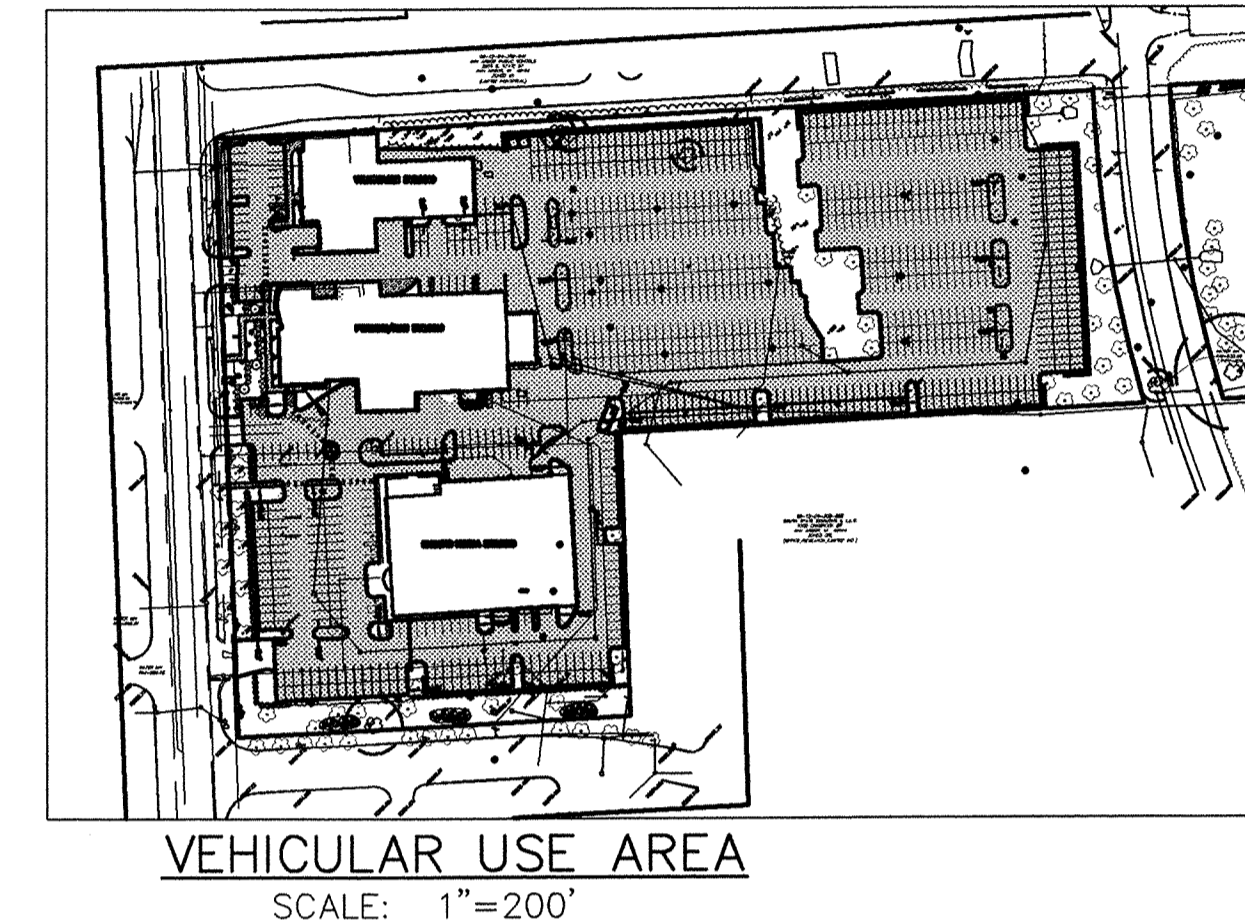
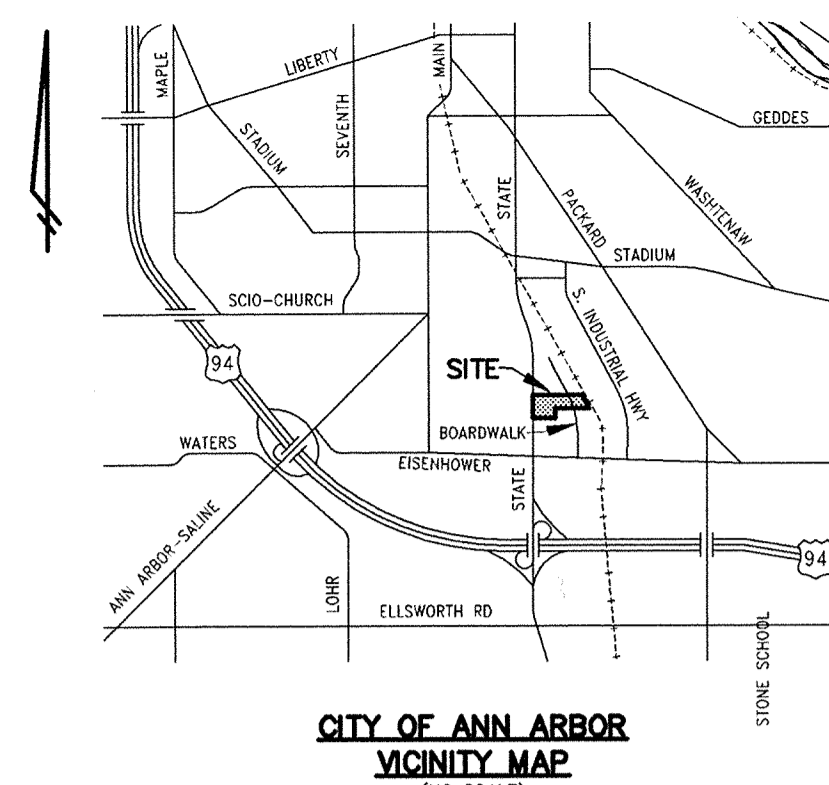
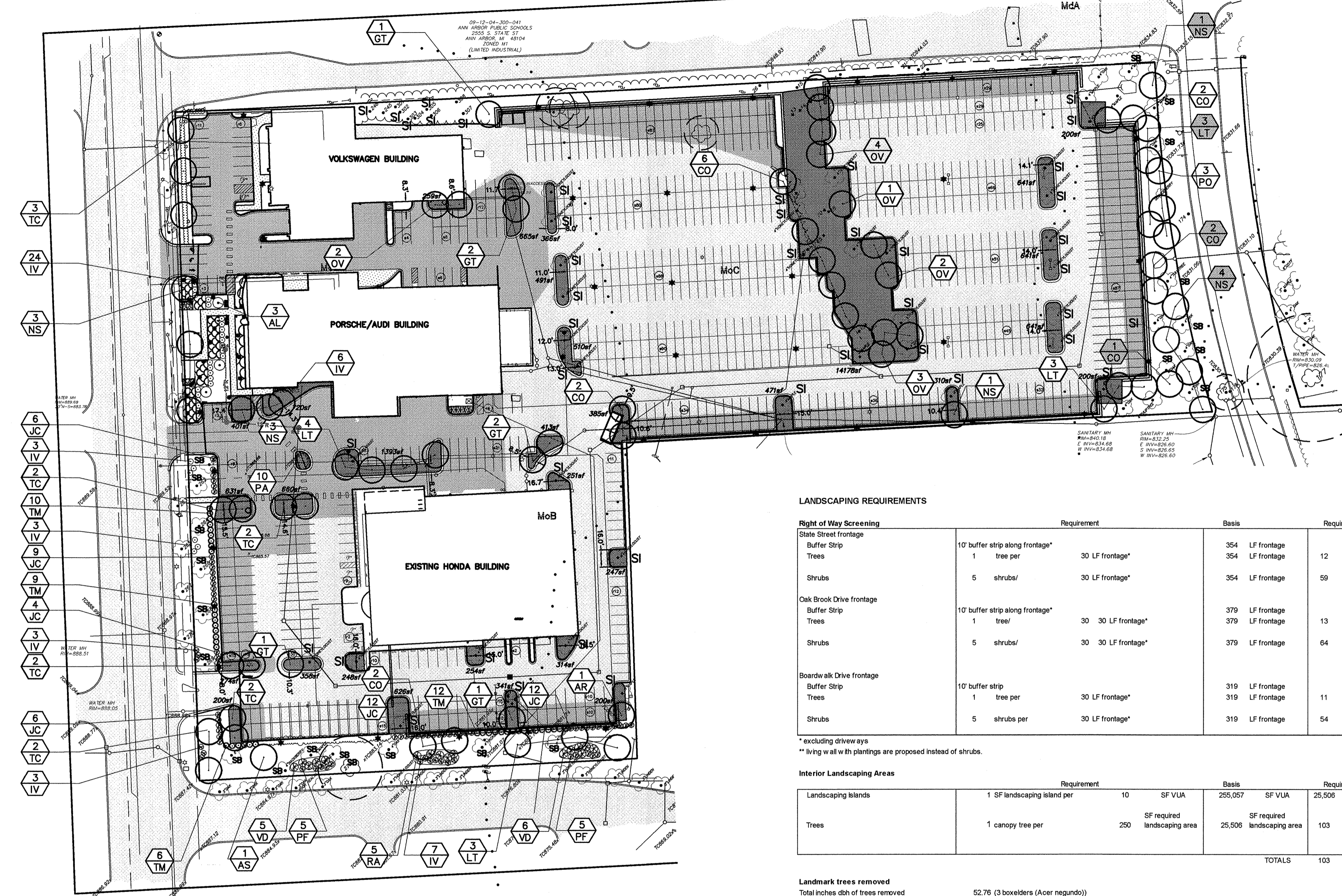

LANDSCAPING REQUIREMENTS

Right of Way Screening	Requirement	Basis	Required	Provided
State Street frontage				
Buffer Strip	10' buffer strip along frontage*	354 LF frontage	12 trees	12.5'-22.7' wide buffer strip along road frontage
Trees	1 tree per 30 LF frontage*	354 LF frontage	5	5 existing trees (shown as SB)
Shrubs	5 shrubs/ 30 LF frontage*	354 LF frontage	24	7 new trees (central NS not counted as buffer tree)
Oak Brook Drive frontage				
Buffer Strip	10' buffer strip along frontage*	379 LF frontage	13 trees	24 existing shrubs
Trees	1 tree/ 30 LF frontage*	379 LF frontage	64 shrubs	79 new shrubs planted 5' o.c.
Shrubs	5 shrubs/ 30 LF frontage*	379 LF frontage	13 trees	34.5' wide buffer strip along road frontage
Boardwalk Drive frontage				
Buffer Strip	10' buffer strip	319 LF frontage	11 trees	8 existing trees (shown as SB)
Trees	1 tree per 30 LF frontage*	319 LF frontage	0	3 new trees
Shrubs	5 shrubs per 30 LF frontage*	319 LF frontage	54 shrubs	75 new shrubs planted 5' o.c.

Interior Landscaping Areas

Landscaping Islands	Requirement	Basis	Required	Provided
Landscaping Islands	1 SF landscaping island per 10 SF VUA	255,057 SF VUA	25,506 SF	27,489 SF in existing and proposed conventional islands
Trees	1 canopy tree per 250 SF required landscaping area	25,506 SF required landscaping area	103 trees	41 Existing trees (shown as SI) 49 Proposed trees
TOTALS			103 trees	90 trees (existing + new) - SEEING A LANDSCAPE MODIFICATION

Landmark trees removed
 Total inches dbh of trees removed 52.76 (3 boxelders (Acer negundo))
 Total landmark mitigation trees required (2.5" cal) 11

Landmark trees saved, with work in critical root zone
 Total inches dbh of trees removed 40.73 (1 boxelder, 1 honeylocust (Gleditsia triacanthos))
 Total landmark mitigation trees required (2.5" cal) 9 (Only planted if trees die within 3 years of project)

PLANT LIST - Does not include Herbaceous Plantings in front of Porsche/Audi Building

SYMBOL	QUANTITY	TYPE	SCIENTIFIC NAME	COMMON NAME	SIZE	COMMENTS
AL	3	Tree	Amelanchier laevis	Serviceberry	4 Feet Ht.	B & B
AR	1	Tree	Acer rubrum 'Franksred'	Red Sunset Red Maple	2.5 Inches Cal.	B & B
AS	1	Tree	Acer saccharum 'Commemoration'	Commemoration Sugar Maple	2.5 Inches Cal.	B & B
CO	15	Tree	Celtis occidentalis	Common Hackberry	2.5 Inches Cal.	B & B
GT	7	Tree	Gleditsia triacanthos 'inermis 'Suncole'	Sunburst Honeylocust	2.5 Inches Cal.	B & B
LT	13	Tree	Liriodendron tulipifera	Tulip Tree	2.5 Inches Cal.	B & B
NS	11	Tree	Nyssa sylvatica	Blackgum	2.5 Inches Cal.	B & B
OV	12	Tree	Ostrya virginiana	American Hopbroombeam	1.75 Inches Cal.	B & B
TC	13	Tree	Tilia cordata 'Greenspire'	Greenspire Linden	2.5 Inches Cal.	B & B
IV	49	Shrub	Ilex verticillata 'Red Sprite'	Red Sprite Winterberry	24 Inches Ht.	CONT.
JC	49	Shrub	Juniperus chinensis 'Sea Green'	Sea Green Juniper	24 Inches Ht.	CONT.
PF	10	Shrub	Potentilla fruticosa 'Goldfinger'	Goldfinger Potentilla	No. 3 0 0	CONT.
PO	2	Shrub	Platanus occidentalis	Sycamore	2.5 Inches Cal.	B & B
RA	5	Shrub	Rhus aromatica	Fragrant Sumac	2 Gal.	CONT.-NOT Gro Low
TM	37	Shrub	Taxus x media 'Flerner'	Flerner Compact Yew	24 Inches Ht.	B & B
VD	11	Shrub	Viburnum dentatum 'Blue Muffin'	Blue Muffin Viburnum	30 Inches Ht.	B & B/CONT.
TREES - INT	50					
TREES - BUF	12					
TREES - MIT	11					
SHRUBS	163					

STREET TREE ESCROW CALCULATIONS

Requirement: \$1.30 per LF frontage

Frontage
 South State St. 625.54 LF
 Oak Brook No. 407.9 LF
 Boardwalk 305.38 LF
 Total 1338.82 LF

Less: Credit for existing trees x 45 feet per existing tree 1035 LF

Net Frontage 303.82 LF

Total Required Escrow \$395.00

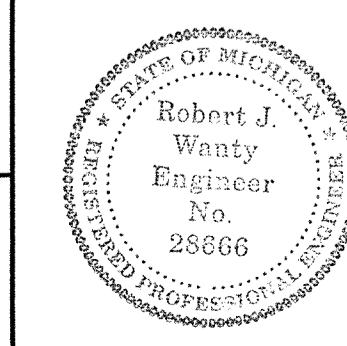

LEGEND

☆ = LIGHT POLE	SPOT ELEV.	TC = TOP OF CURB	--- = GRAVEL	--- = EXISTING STORM
○ = UTILITY POLE	POST	TW = TOP OF WALL	--- = FENCE	--- = EXISTING SANITARY
⊕ = GUY ANCHOR	MANHOLE	○ = MANHOLE	--- = CONCRETE	--- = EXISTING WATER
⊕ = HYDRANT	CATCH BASIN	○ = CATCH BASIN	--- = ASPHALT	--- = EXISTING GAS
	END SECTION	--- = END SECTION		--- = EXISTING ELECTRIC
				--- = EXISTING TELEPHONE

BENCHMARK
 BM1=STEAMER VALVE ON HYDRANT IN FRONT OF 2575 S. STATE ST., ELEV=891.31.
 BM2=CITY OF ANN ARBOR NO. 0113 NORTH OF DRIVE TO 2555 S. STATE ST. AND ON EAST SIDE OF STATE ST., ELEV=887.49.

REVISIONS - 10-22-2013 PER CITY, 10-28-2013 PER CITY, 11-5-2013 PER CITY

NO.	DATE	DESCRIPTION

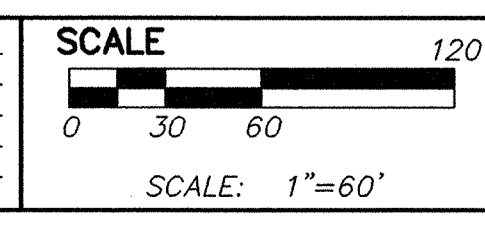

PREPARED BY: Robert J. Wanty
 ROBERT J. WANTY P.E., MCH No. 28666

PROJECT: GERMAIN OF ANN ARBOR CAMPUS IMPROVEMENTS

ARCHITECTURAL ALLIANCE
 165 NORTH FIFTH ST
 COLUMBUS, OH 43215
 TEL: 614-469-7800
 FAX: 614-469-0900
 www.archall.com

CLIENT: WASHTENAW ENGINEERING

SECTION: 4 TOWN: 3 SOUTH: 6 RANGE: 6 EAST: 10 SHEET

GENERAL LANDSCAPE NOTES

- ALL WORKMANSHIP AND MATERIALS SHALL CONFORM TO CITY OF ANN ARBOR STANDARDS AND SPECIFICATIONS. ALL PLANT MATERIAL SHALL BE NURSERY GROWN AND ALL SIZES AND MEASUREMENTS SHALL CONFORM TO THE USA STANDARD FOR NURSERY STOCK. ALL PLANT MATERIAL SHALL BE OF SELECTED SPECIMEN QUALITY AND HAVE A NORMAL HABIT OF GROWTH. ALL PLANT MATERIAL IS SUBJECT TO THE APPROVAL OF THE LANDSCAPE ARCHITECT.
- ALL PLANT MATERIAL SHALL BE BALLED AND BURLAPPED STOCK OR CONTAINER STOCK. NO BARE ROOT STOCK IS PERMITTED. ALL PLANT BALLS SHALL BE FIRM, INTACT AND SECURELY WRAPPED AND BOUND.
- ALL PLANT BEDS SHALL BE EXCAVATED OF ALL BUILDING MATERIALS AND OTHER EXTRANEOUS OBJECTS AND POOR SOILS TO A MINIMUM DEPTH OF TWELVE INCHES (12") AND ALL BACKFILLED TO GRADE WITH PLANTING MIX (SEE BELOW).
- PLANTING MIXTURE SHALL CONFORM TO 2012 M.D.O.T. SPECIFICATION 815.02
- ALL PLANT BEDS AND INDIVIDUAL PLANTS SHALL BE MULCHED WITH A THREE INCH (3") LAYER OF SHREDDED BARK MULCH. MULCH SHALL CONFORM TO 2012 M.D.O.T. SPECIFICATION 917.14.
- ALL PLANTS AND PLANT BEDS SHALL BE THOROUGHLY WATERED AS DESCRIBED IN SECTION 815.03 (M.D.O.T. 2012 STANDARD SPECIFICATION.)
- THE CONTRACTOR SHALL GUARANTEE ALL PLANT MATERIALS FOR A PERIOD OF ONE (1) YEAR FROM THE DATE THE WORK IS ACCEPTED, IN WRITING, BY THE LANDSCAPE ARCHITECT. THE CONTRACTOR SHALL REPLACE, WITHOUT COST TO THE OWNER, WITHIN A SPECIFIED PERIOD TIME, ALL DEAD PLANTS, AND ALL PLANTS NOT IN A VIGOROUS, THRIVING CONDITION, AS DETERMINED BY THE LANDSCAPE ARCHITECT DURING AND AT THE END OF THE GUARANTEE PERIOD. REPLACEMENT STOCK SHALL CONFORM TO THE ORIGINAL REQUIREMENTS.
- EDGING, WHERE NOTED ON THE PLANS, SHALL BE RYERSON STEEL EDGING, 3/16" x 4". INSTALL PER MANUFACTURER'S INSTRUCTIONS. ALL EDGING SHALL BE INSTALLED IN STRAIGHT, STRAIGHT, TRUE LINES WITHOUT IRREGULARITIES.
- ALL AREAS OF THE SITE THAT BECOME DISTURBED DURING CONSTRUCTION AND ARE NOT TO BE PAVED, STONED, LANDSCAPED, OR SODDED SHALL BE SEEDED AND MULCHED.
 - SEED MIXTURE SHALL BE THM MIX PLANTED ACCORDING TO 2012 M.D.O.T. SPECIFICATION 816 AND 816-1A INCLUDING PLACEMENT OF 4 INCH TOPSOIL BED.
 - SOD, WHERE SPECIFIED, SHALL BE CLASS B PLANTED PER 2012 M.D.O.T. SPECIFICATION 816.
- IT IS THE RESPONSIBILITY OF THE CONTRACTOR TO ESTABLISH A DENSE LAWN OF PERMANENT GRASSES, FREE OF LUMPS AND DEPRESSIONS. ANY PART OF THE AREA THAT FAILS TO SHOW A UNIFORM GERMINATION SHALL BE RESEEDED AND SUCH RESEEDING SHALL CONTINUE UNTIL A DENSE LAWN IS ESTABLISHED. DAMAGE TO SEEDED AREAS RESULTING FROM EROSION SHALL BE REPAIRED BY THE CONTRACTOR.
- ALL AREAS OF THE SITE SCHEDULED FOR SEEDING OR SODDING SHALL FIRST RECEIVE A FOUR INCH (4") LAYER OF CLEAN, FRIABLE TOPSOIL. THIS SOIL SHALL BE DISCED AND SHALL BE GRADED IN CONFORMANCE WITH THE GRADING PLAN.
- IT IS THE CONTRACTOR'S RESPONSIBILITY TO LOCATE THE UTILITIES, BOTH ABOVE AND UNDERGROUND PRIOR TO LANDSCAPING. ANY CONFLICTS BETWEEN UTILITIES AND PLANT MATERIAL SHALL BE REPORTED TO THE LANDSCAPE ARCHITECT.

THE UNDERGROUND UTILITIES SHOWN HAVE BEEN LOCATED FROM FIELD SURVEY INFORMATION AND EXISTING RECORDS. THE SURVEYOR HAS MADE NO GUARANTEE THAT THE UNDERGROUND UTILITIES SHOWN COMPRISE ALL SUCH UTILITIES IN THE AREA, EITHER IN-SERVICE OR ABANDONED. THE SURVEYOR DOES NOT WARRANT THAT THE UNDERGROUND UTILITIES SHOWN ARE IN THE EXACT LOCATION INDICATED, NOR DOES HE GUARANTEE THAT THE UTILITIES ARE AS SHOWN, AS FAR AS POSSIBLE FROM INFORMATION AVAILABLE. THE SURVEYOR HAS NOT PHYSICALLY LOCATED THE UNDERGROUND UTILITIES.

COPYRIGHT © 2013 WASHTEENAW ENGINEERING COMPANY, INC. NO REPRODUCTION SHALL BE MADE WITHOUT PRIOR WRITTEN CONSENT OF WASHTEENAW ENGINEERING COMPANY, INC.

THE OWNER SHALL NOT USE OR AUTHORIZE ANY OTHER PERSON TO USE THE DRAWINGS, SPECIFICATIONS, ELECTRONIC DATA AND BY OTHERS SO LONG AS WASHTEENAW ENGINEERING COMPANY (WECO) IS NOT ADVISED TO THE CONTRARY UNDER THIS AGREEMENT. WECO SHALL BE RESPONSIBLE FOR THE ACCURACY OF THE INFORMATION PROVIDED TO WECO FROM THE FIELD AND AGAINST CLAIMS, DAMAGES, LOSSES AND EXPENSES, INCLUDING BUT NOT LIMITED TO ATTORNEY'S FEES, ARISING OUT OF UNAUTHORIZED REUSE OF DRAWINGS, SPECIFICATIONS, ELECTRONIC DATA OR OTHER INSTRUMENTS OF SERVICE.

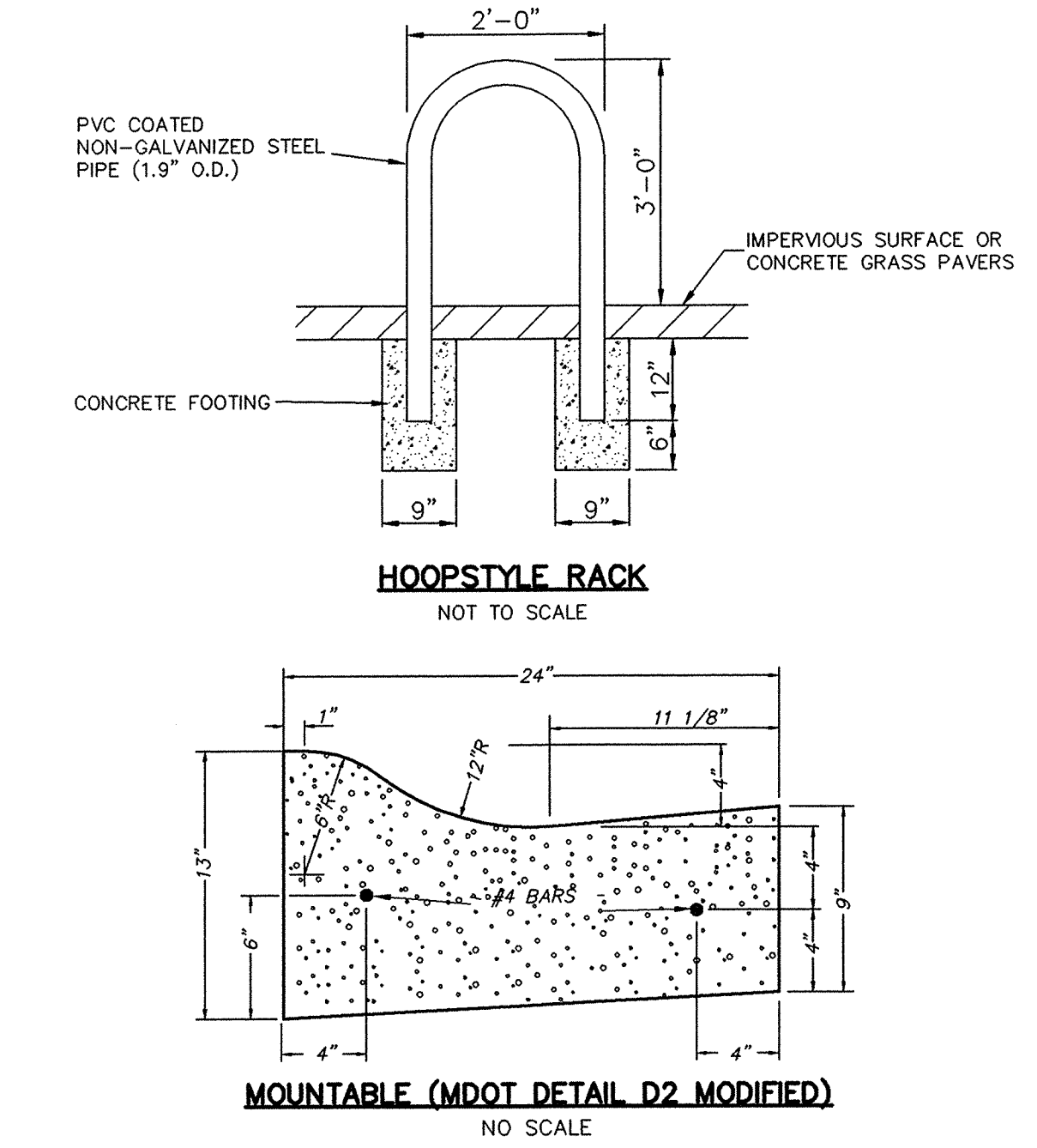
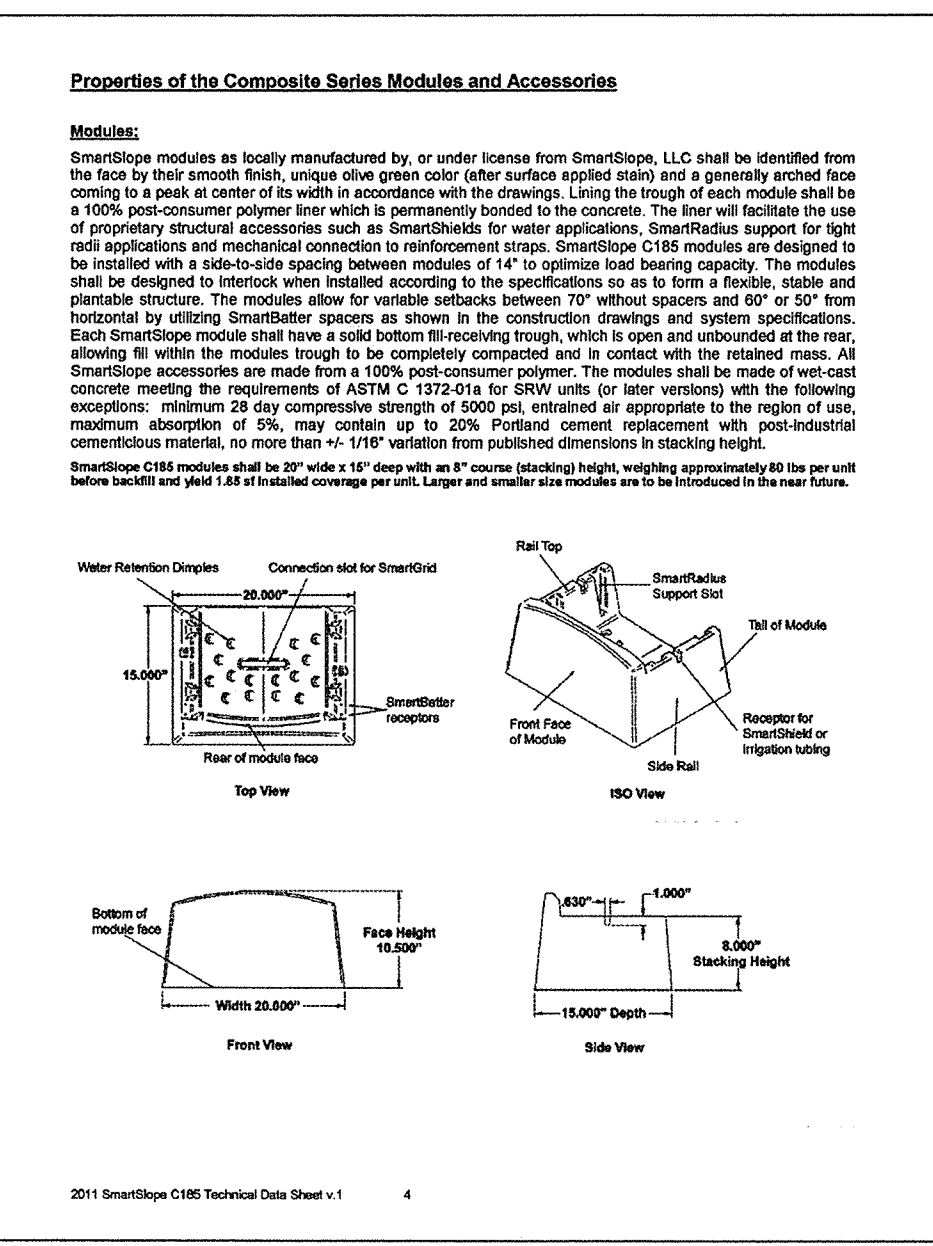
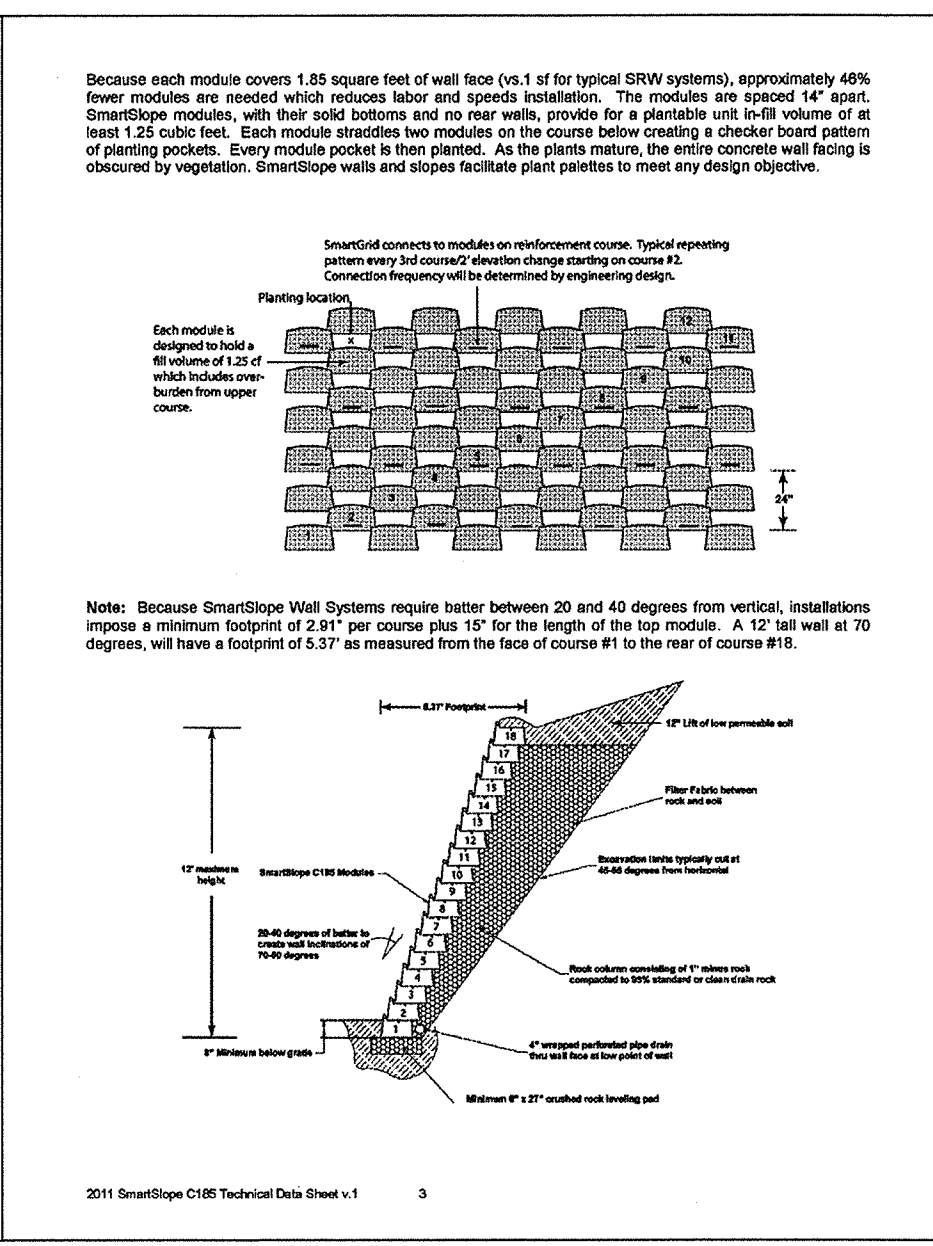
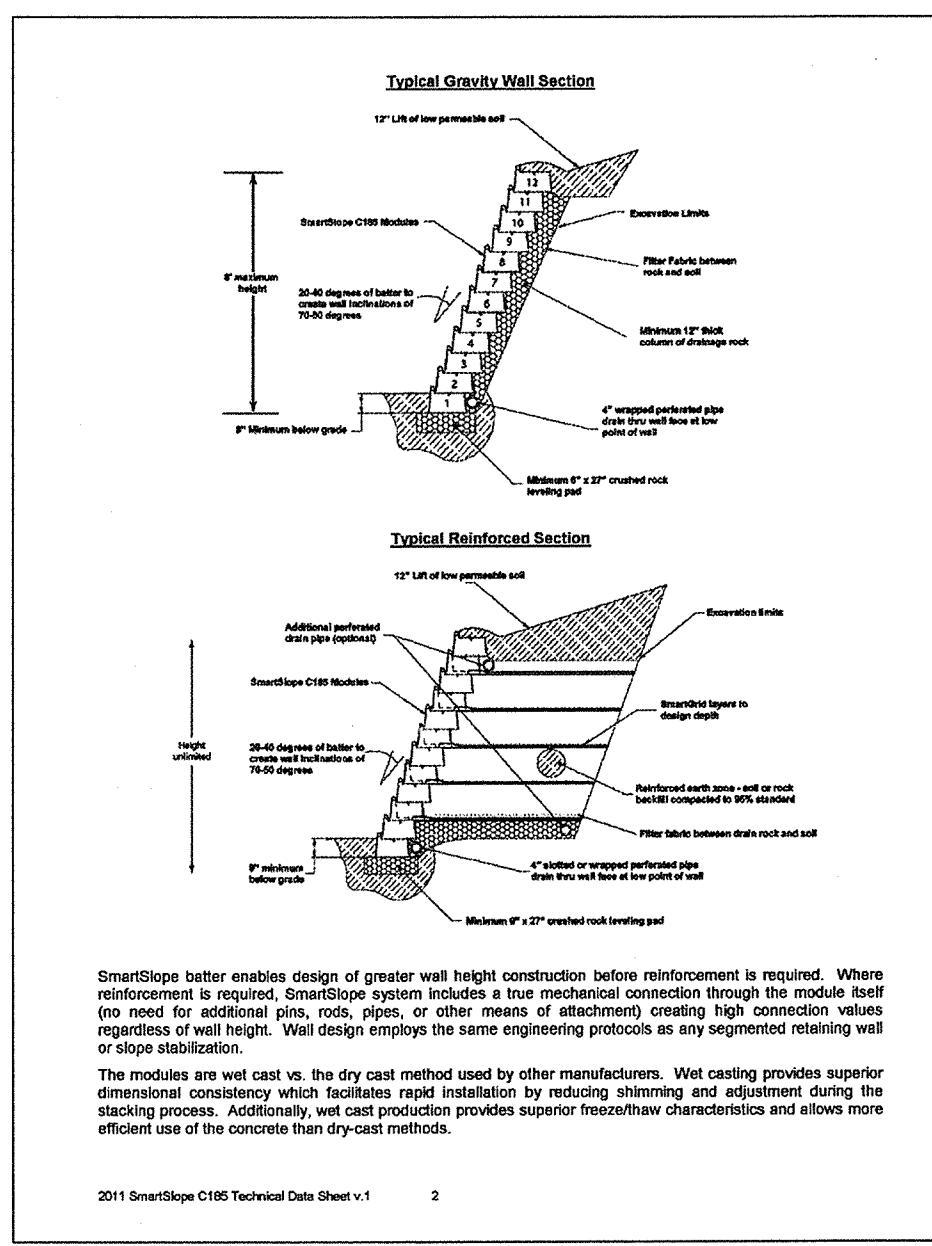
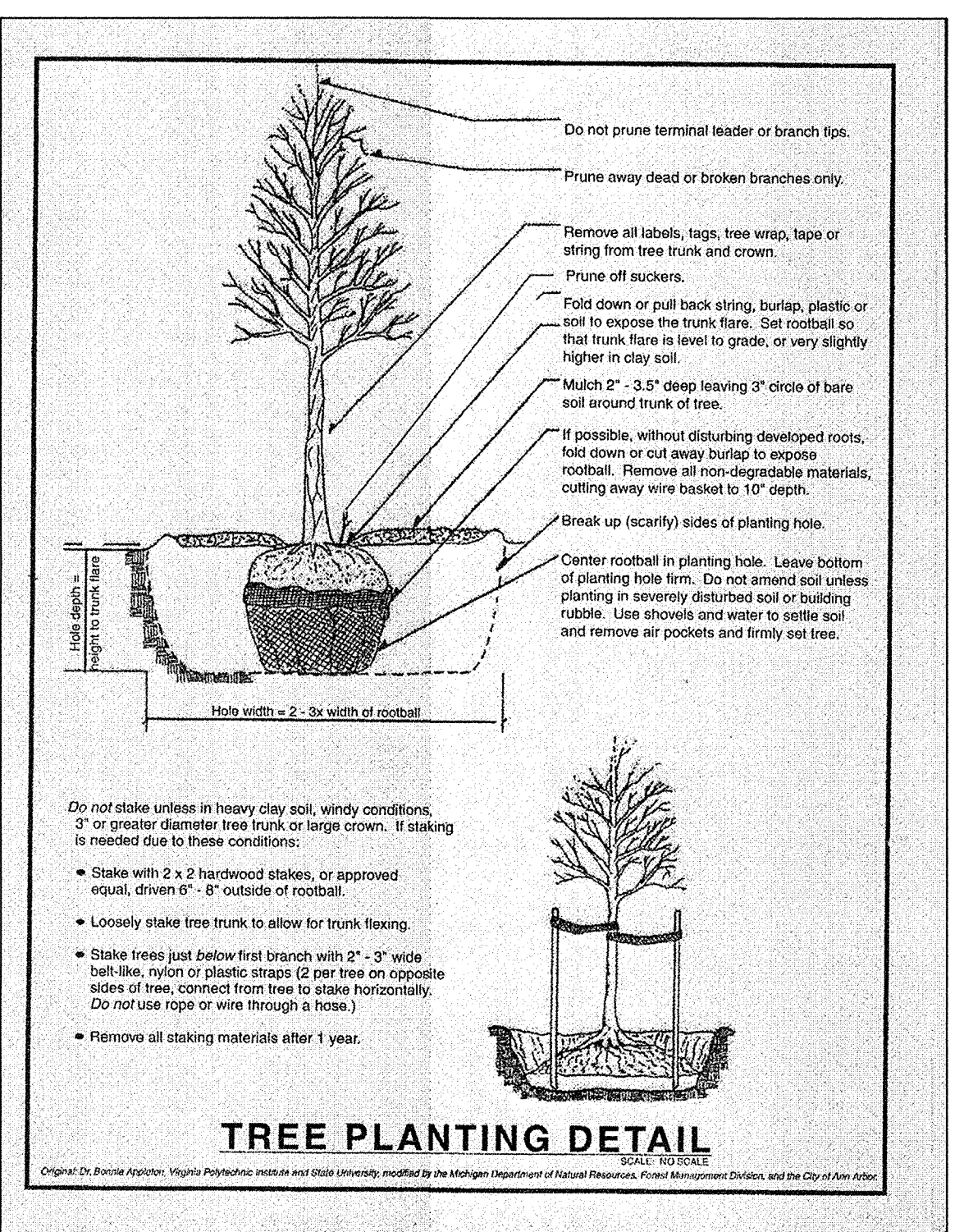
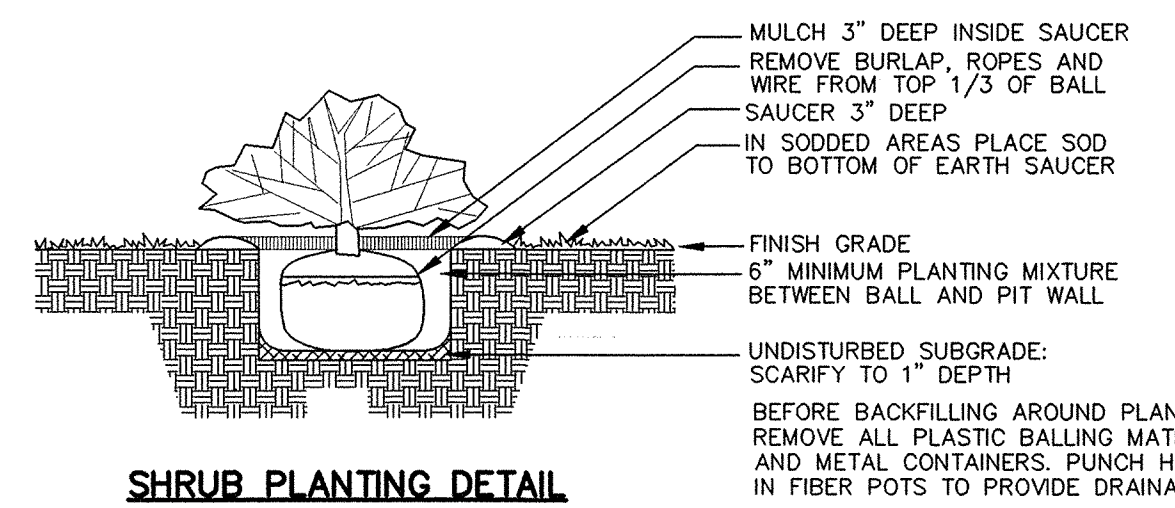

LIVING WALL DETAILS
NO SCALE

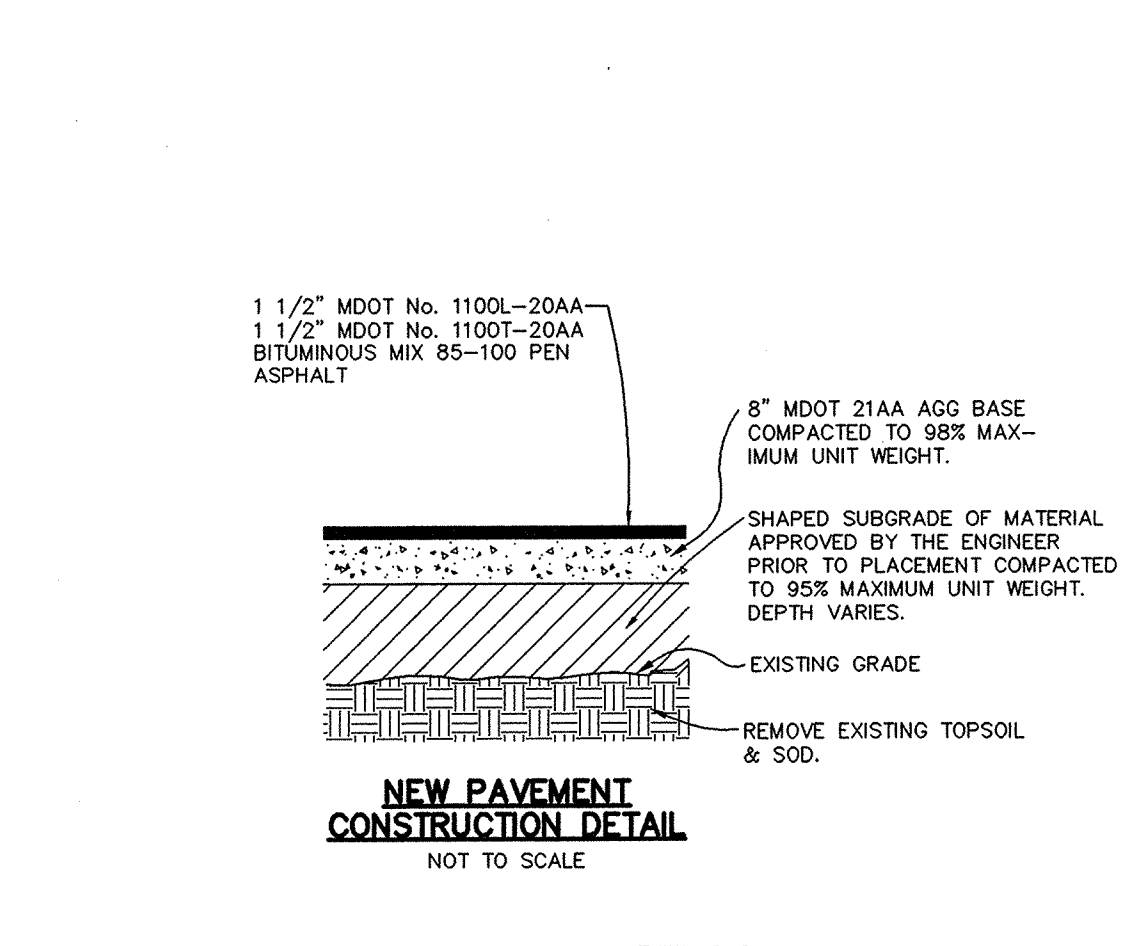

LIVING WALL PLANT LIST - Shade tolerant species - north-facing walls

SCIENTIFIC NAME	COMMON NAME	PLANT TYPE	COMMENTS
Aster cordifolia	Heart-leaved Aster	Perennial	Plug
Carex pensylvanica	Pennsylvania Sedge	Sedge	Plug
Carex rosea	Rosy Sedge	Sedge	Plug
Carex sprengei	Sprengel's Sedge	Sedge	Plug
Desmodium illinoense	Woodland Tick Trefail	Perennial	Plug
Elymus hystrix	Bottlebrush Grass	Grass	Plug
Euonymus obovata	Creeping Strawberry-bush	Vine	Plug
Geranium maculatum	Wild Geranium	Perennial	Plug
Heuchera americana	Alum Root	Perennial	Plug
Parthenocissus quinquefolia	Virginia Creeper	Vine	Plug
Solidago caesia	Bluestem Goldenrod	Perennial	Plug
Tierella cordifolia	Foamflower	Plug	Plug

LIVING WALL PLANT LIST - Sun/partial shade tolerant species - east-facing walls

SCIENTIFIC NAME	COMMON NAME	PLANT TYPE	COMMENTS
Carex lanceolata	Sand Carex	Perennial	Plug
Tradescantia ohiensis	Spiderwort	Sedge	Plug
Fragaria virginiana	Wild Strawberry	Vine	Plug
Schizachyrium scoparium	Little Bluestem	Grass	Plug
Rudbeckia triloba	Brown-eyed Susan	Perennial	Plug
Heuchera americana	Alum Root	Perennial	Plug
Allium canadense	Nodding Wild Onion	Perennial	Plug
Geranium maculatum	Wild Geranium	Perennial	Plug
Penstemon hirsutus	Rough beardtongue	Perennial	Plug
Parthenocissus quinquefolia	Virginia Creeper	Vine	Plug
Zizia aurea	Golden Alexander	Perennial	Plug
Senecio obovatus	Round-leaved Ragwort	Perennial	Plug
Aster laevis	Smooth Aster	Perennial	Plug
Solidago nemoralis	Early Goldenrod	Perennial	Plug

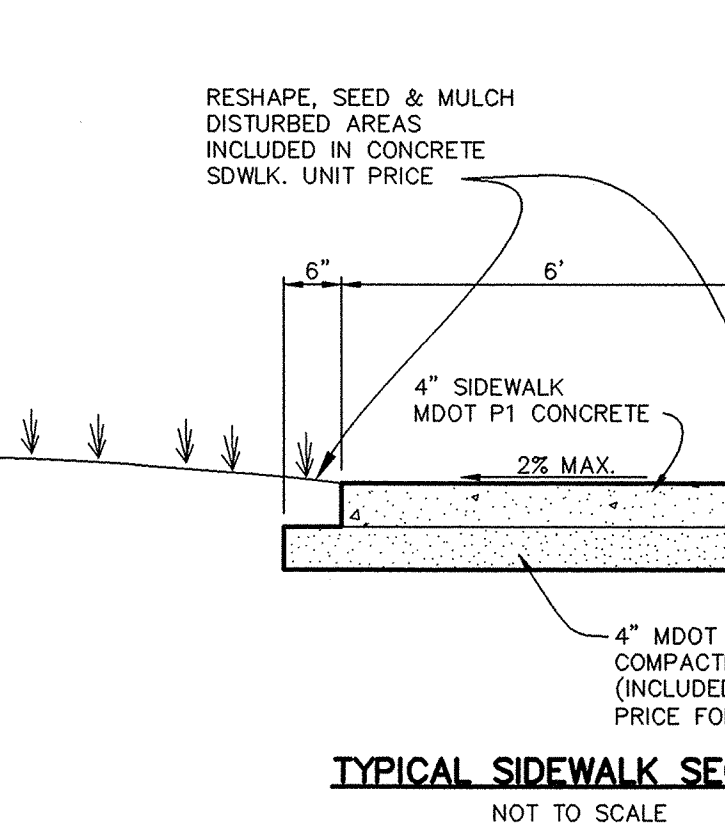
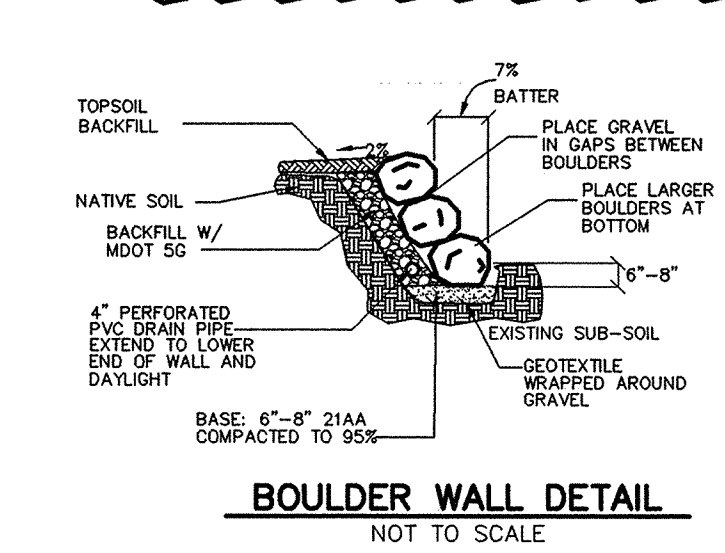
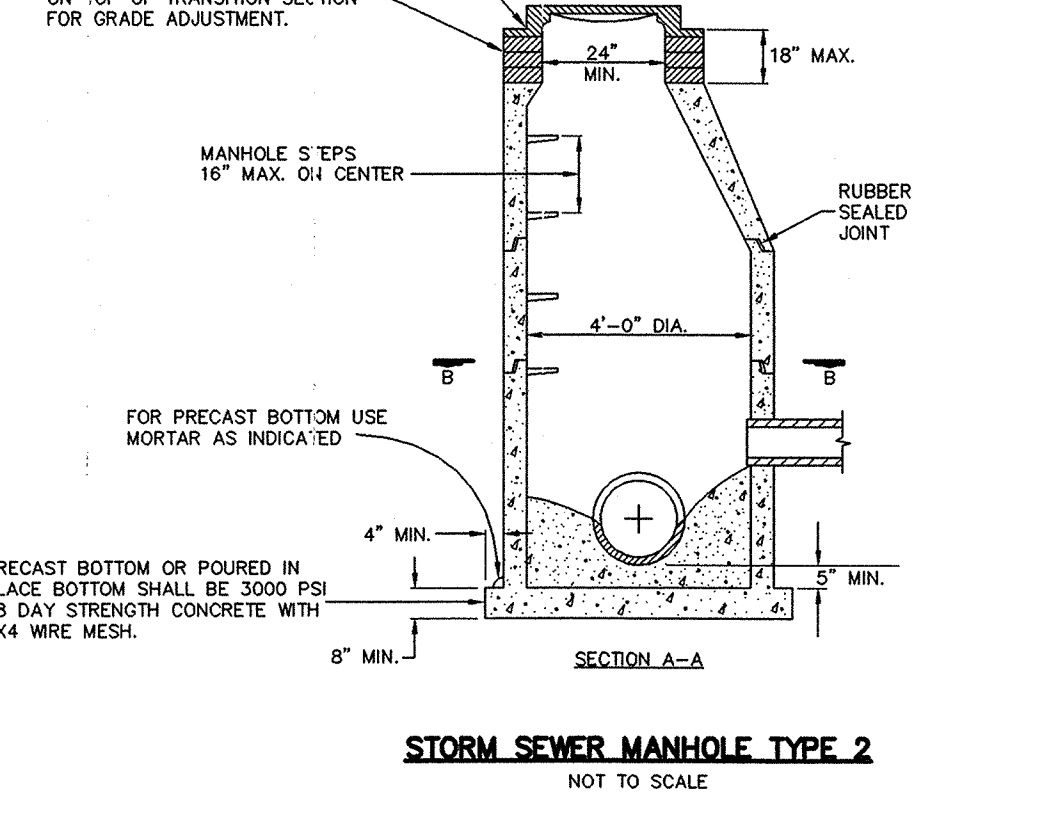
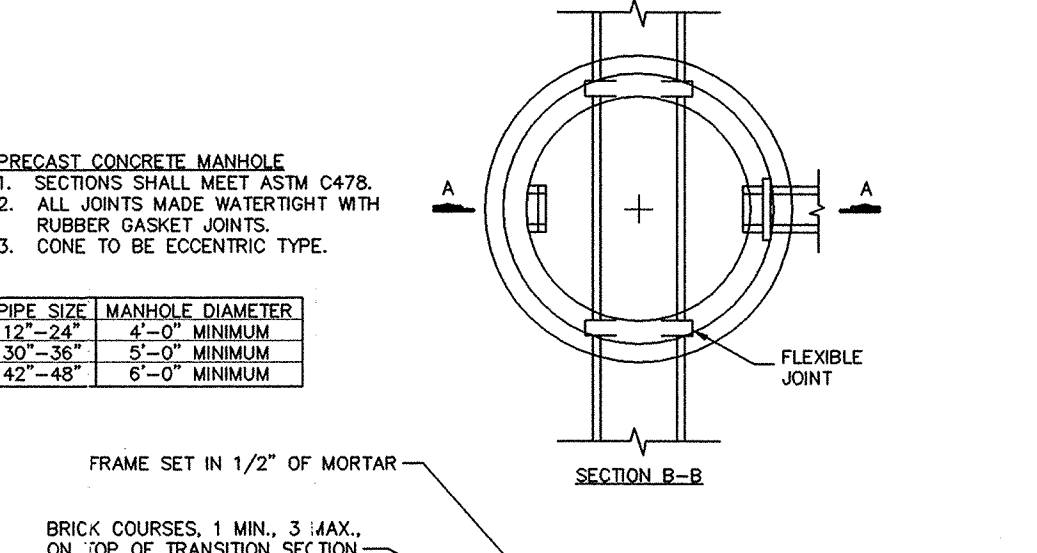
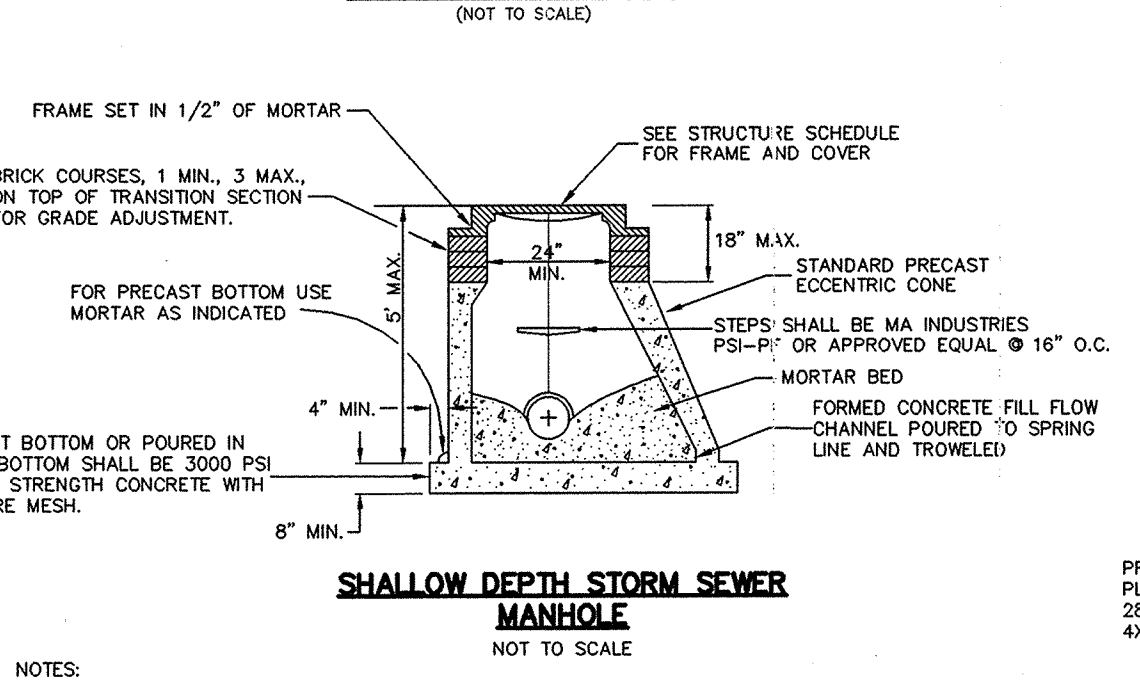
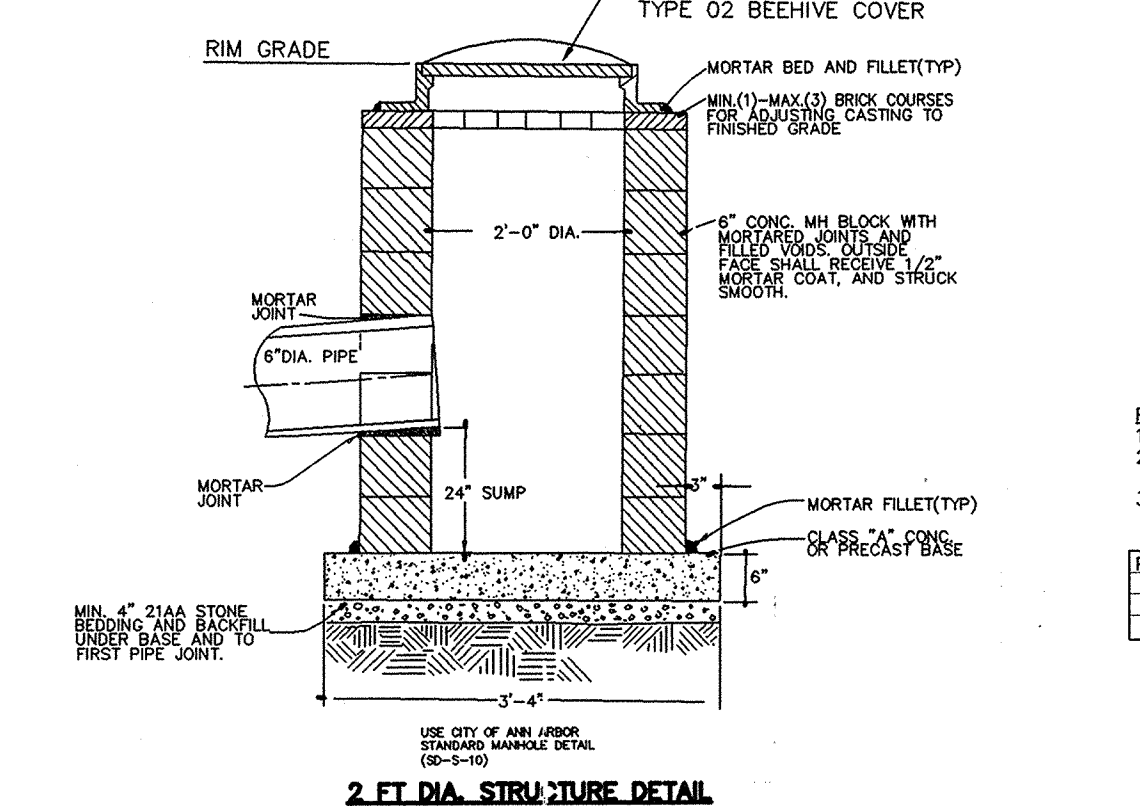
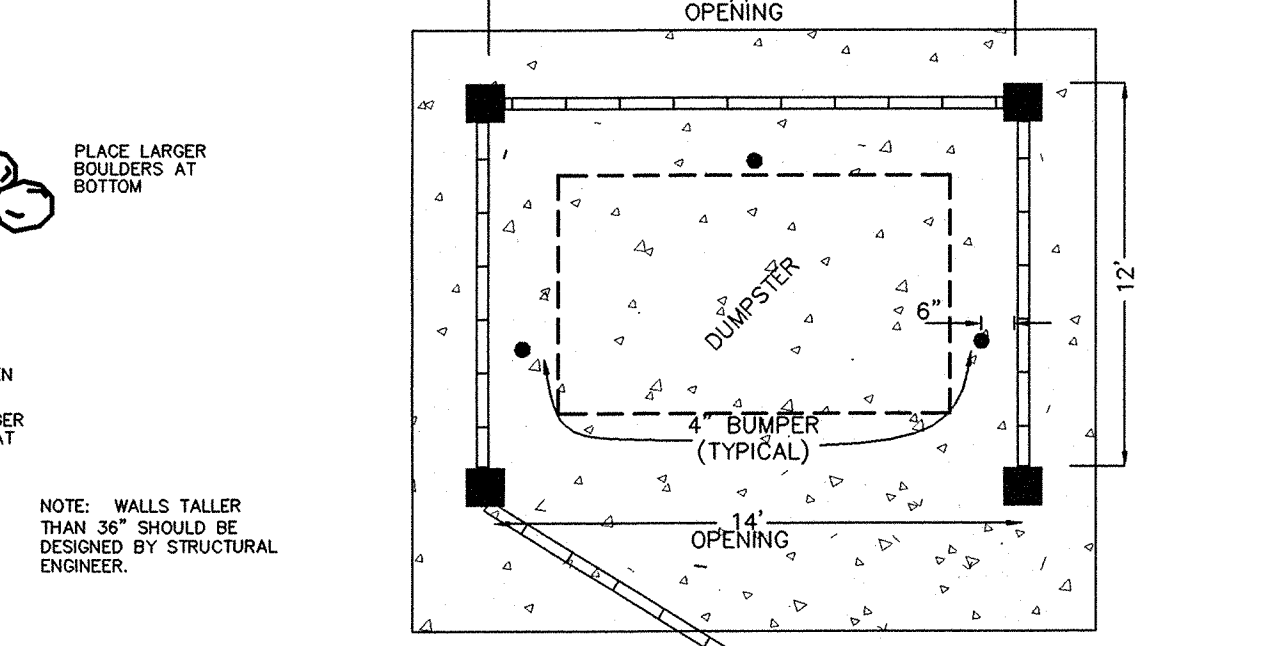
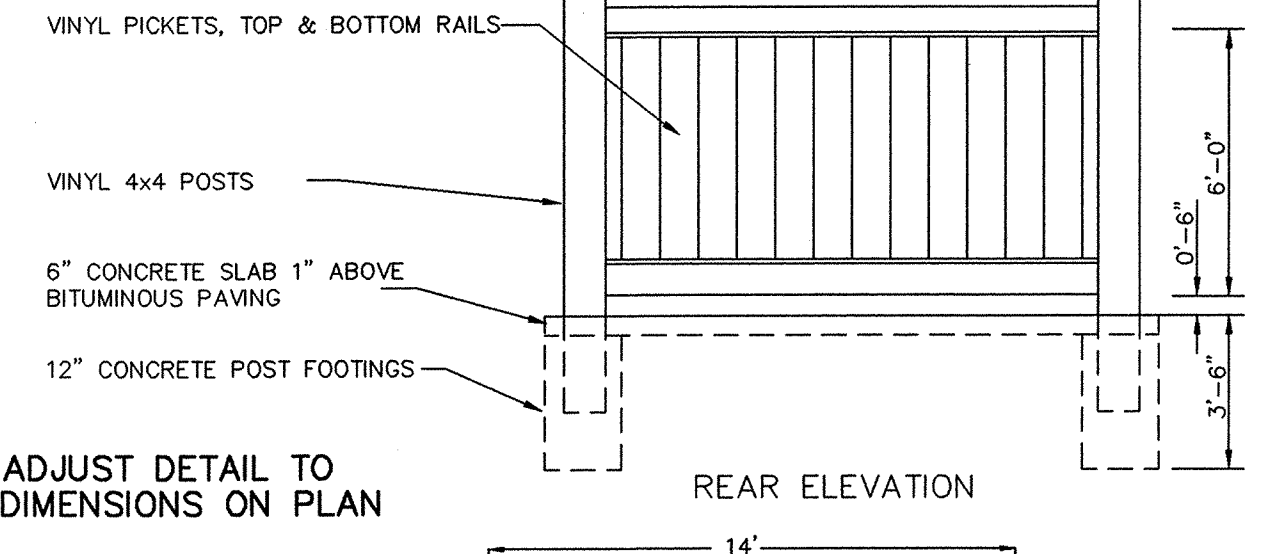
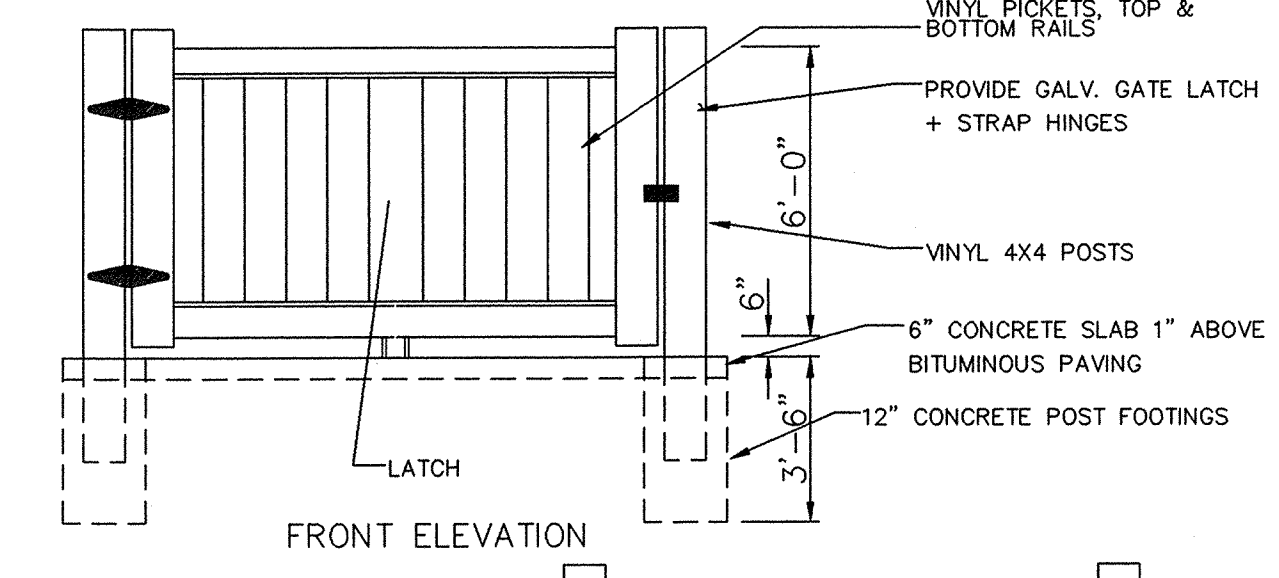

LEGEND

○ = LIGHT POLE	● = SPOT ELEV.	--- = GRAVEL	— = EXISTING STORM
○ = UTILITY POLE	○ = POST	--- = FENCE	— = EXISTING SANITARY
○ = GUY ANCHOR	○ = GATE VALVE	○ = MANHOLE	— = EXISTING WATER
○ = HYDRANT	— = END SECTION	○ = CATCHBASIN	— = EXISTING GAS
		○ = ASPHALT	— = EXISTING ELECTRIC
			— = EXISTING TELEPHONE

BENCHMARK
BM1-STEAMER VALVE ON HYDRANT IN FRONT OF 2575 S. STATE ST., ELEV=891.31.
BM2-CITY OF ANN ARBOR NO. 0113 NORTH OF DRIVE TO 2555 S. STATE ST. AND ON EAST SIDE OF STATE ST., ELEV=887.49.

REVISIONS - 10-22-2013 PER CITY, 10-28-2013 PER CITY, 11-5-2013 PER CITY

NO.	DATE	DESCRIPTION

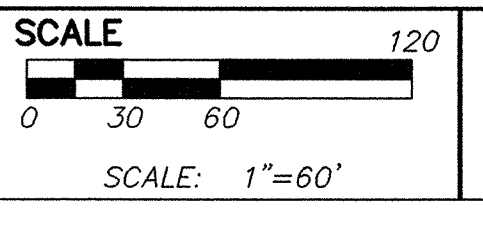

PREPARED BY **Robert J. Wanty**
ROBERT J. WANTY P.E., MICH No. 28666

CIVIL ENGINEERS
PLANNERS • SURVEYORS
LANDSCAPE ARCHITECTS
3526 W. LIBERTY RD.
SUITE 400
ANN ARBOR, MI 48103
TEL: 734-761-9850
FAX: 734-761-9850
WASHTEENAWENGINEERING.COM

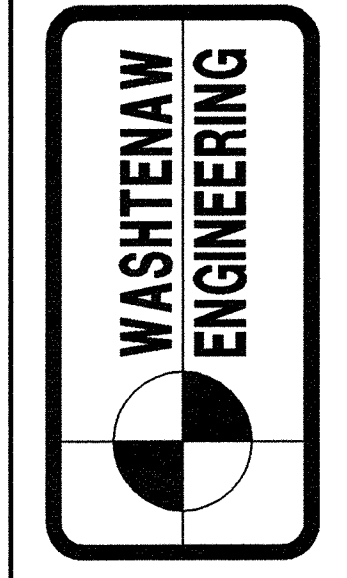

ARCHITECTURAL ALLIANCE
165 NORTH FIFTH ST.
COLUMBIA, MI 48105
TEL: 616-468-2500
FAX: 616-468-0500
www.archall.com

DETAILS

GERMAIN OF ANN ARBOR CAMPUS IMPROVEMENTS

SECTION 4 TOWN 3 SOUTH RANGE 6 EAST
PROJECT WASHTEENAW COUNTY • MICHIGAN
JOB NO. 31667
DWG NO. 667-11-details
FIELD BOOK 556, 649
FILE NO. 10027

DATE 9-30-13
SHEET 11



Know what's below. Call what you dig.

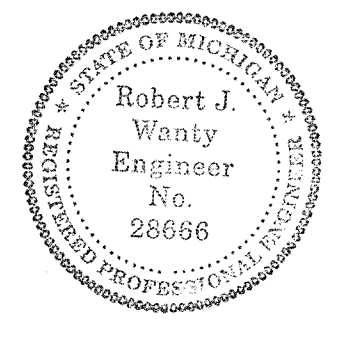

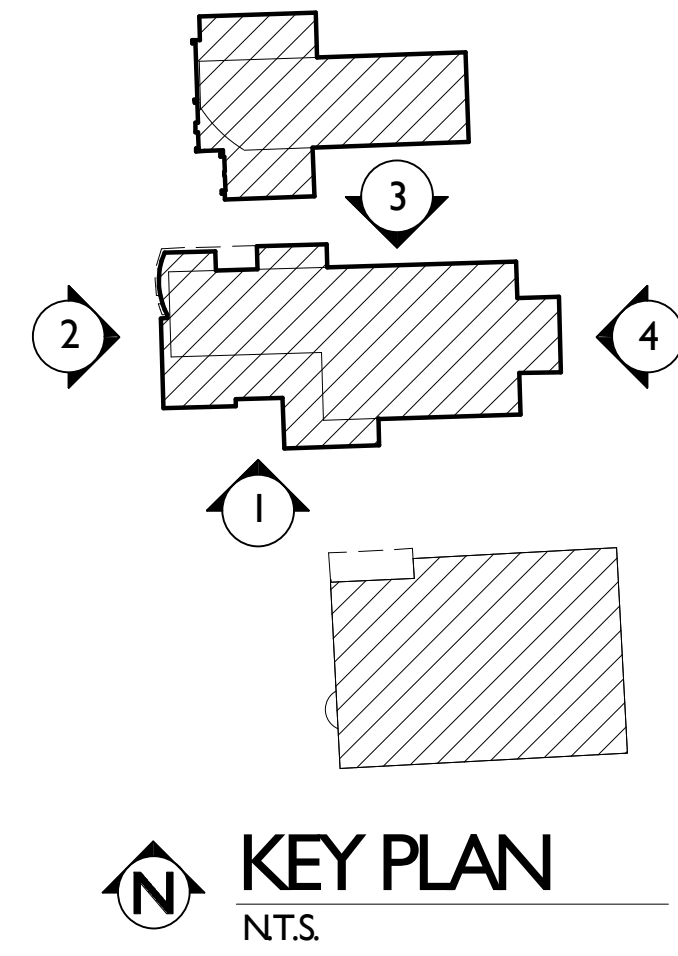

KEY PLAN
N.T.S.

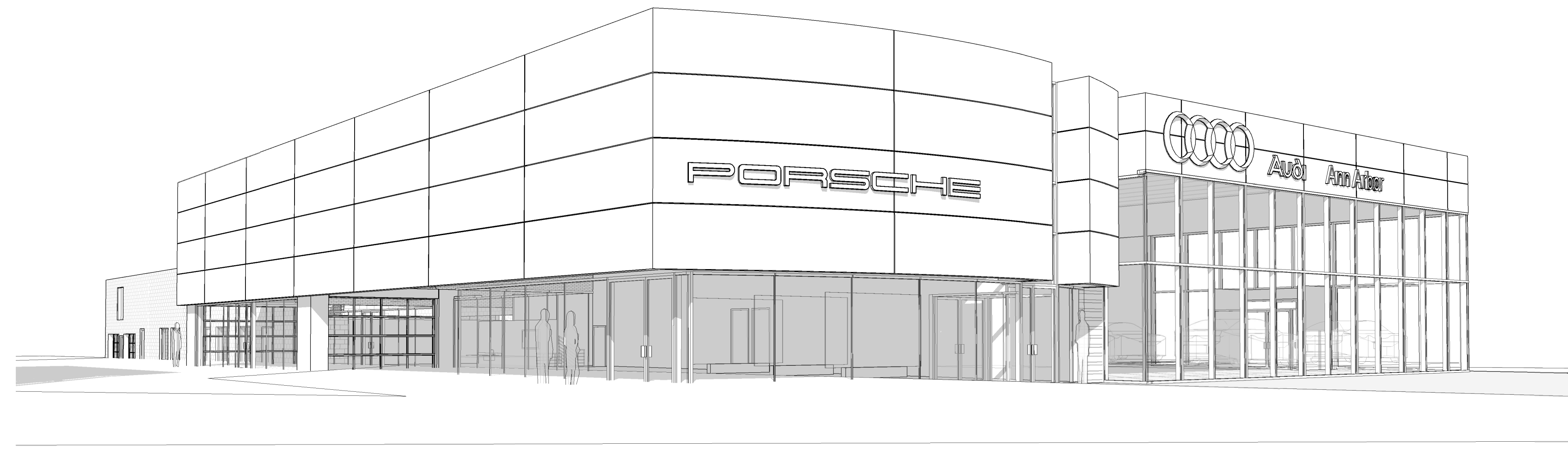

GENERAL NOTES

- REVEALS TO ALIGN WITH ADJACENT MULLIONS, AND DOOR + WINDOW OPENINGS U.I.D.
- ALL COPING, OVERFLOW PENETRATIONS, AND BREAK METAL TO BE CLEAR ANODIZED ALUMINUM

CODED NOTES - ELEVATION

- ACM-1** ALUMINUM COMPOSITE MATERIAL
REFER TO WALL SECTIONS AND FINISH SCHEDULE
- ACM-2** ALUMINUM COMPOSITE MATERIAL
REFER TO WALL SECTIONS AND FINISH SCHEDULE
- MP-1** METAL PANEL
REFER TO WALL SECTIONS AND FINISH SCHEDULE
- ECMU-1** EXISTING CMU
REFER TO WALL SECTIONS AND FINISH SCHEDULE

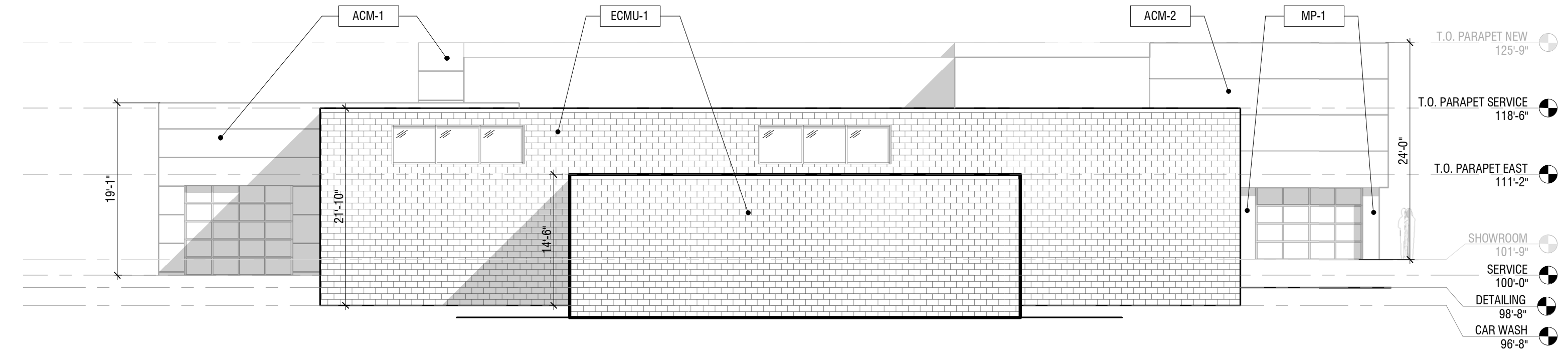

4 New - East Elevation
SCALE 3/32" = 1'-0"

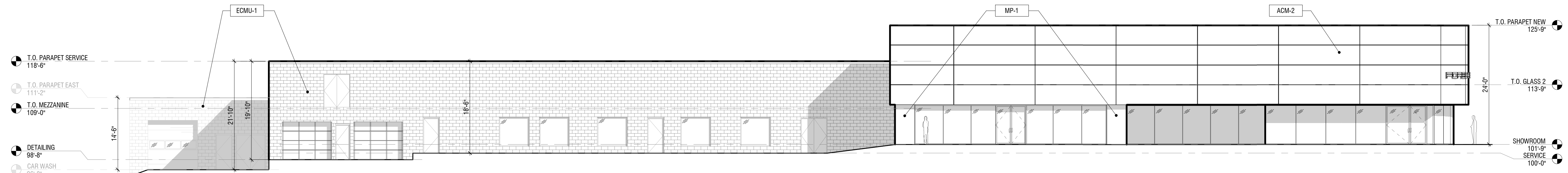

3 New - North Elevation
SCALE 3/32" = 1'-0"

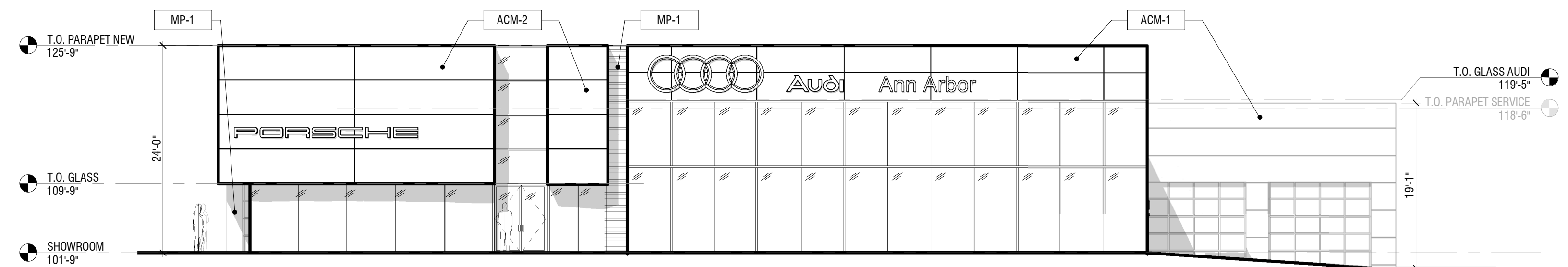

2 New - West Elevation
SCALE 3/32" = 1'-0"

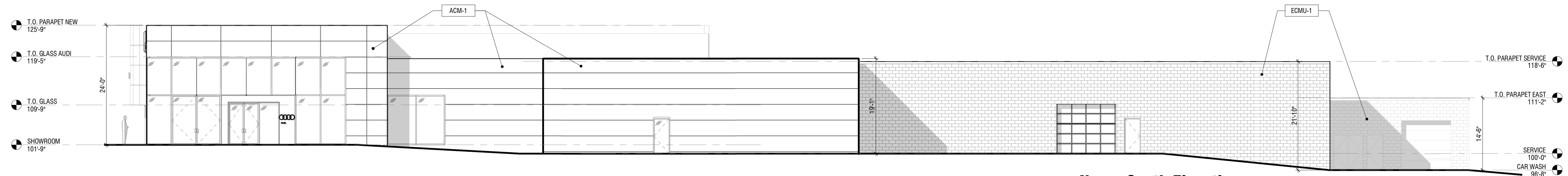

1 New - South Elevation
SCALE 3/32" = 1'-0"

Set

Drawings

- Preliminary 09 / 30 / 13
- Bid Set
- Permit Set
- Construction

Revisions

- ▲
- ▲
- ▲
- ▲
- ▲



Project Number
A13-030

Sheet Title
ELEVATIONS NEW - AUDI PORSCHE

Sheet Number

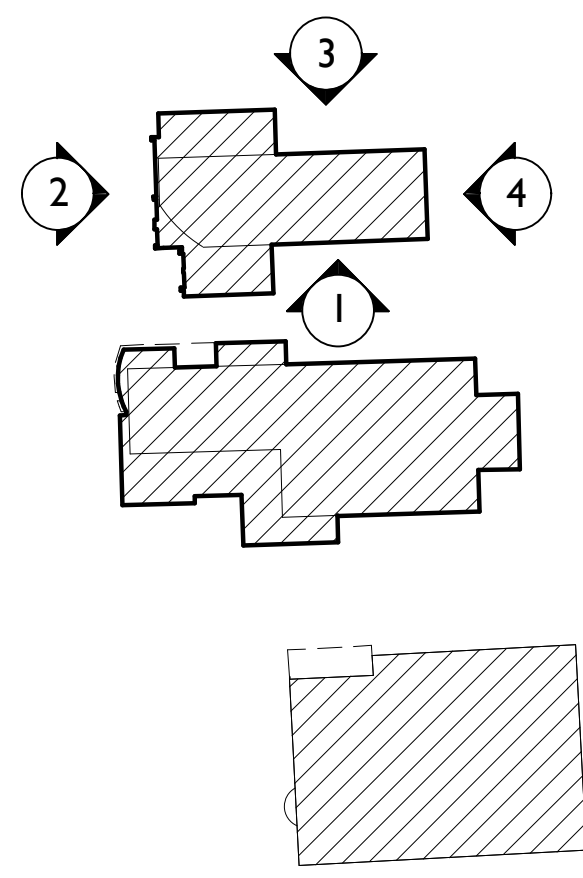

KEY PLAN
N.T.S.

GENERAL NOTES

- REVEALS TO ALIGN WITH ADJACENT MULLIONS, AND DOOR + WINDOW OPENINGS U.N.O.
- ALL COPING, OVERFLOW PENETRATIONS, AND BREAK METAL TO BE CLEAR ANODIZED ALUMINUM

CODED NOTES - ELEVATION

- ACM-1** ALUMINUM COMPOSITE MATERIAL
REFER TO WALL SECTIONS AND FINISH SCHEDULE
- MP-1** METAL PANEL
REFER TO WALL SECTIONS AND FINISH SCHEDULE
- ECMU-1** EXISTING CMU
REFER TO WALL SECTIONS AND FINISH SCHEDULE

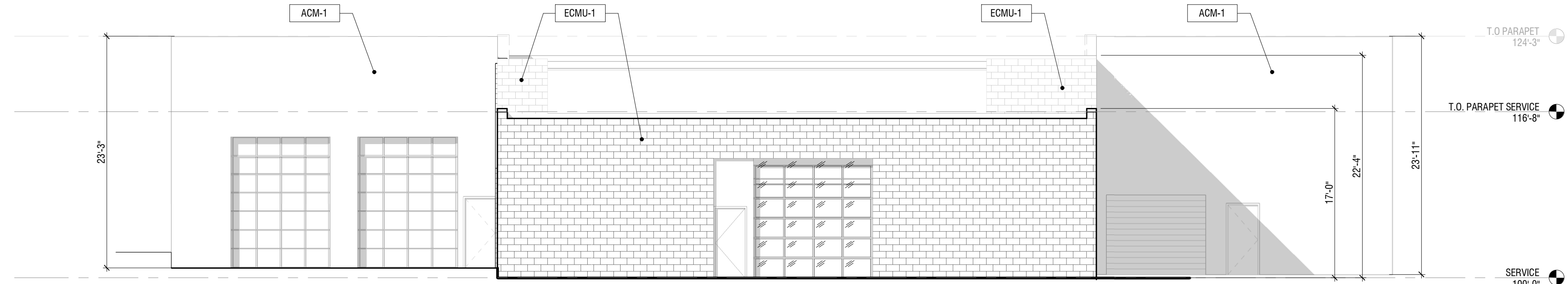

4 EAST ELEVATION - NEW
SCALE 1/8" = 1'-0"

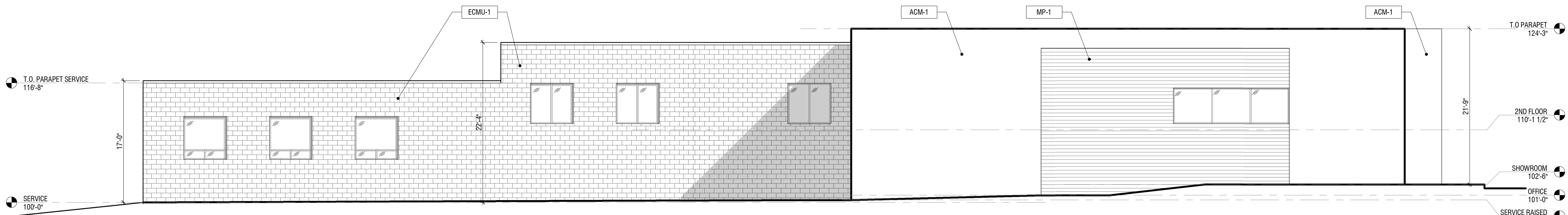

3 NORTH ELEVATION - NEW
SCALE 1/8" = 1'-0"

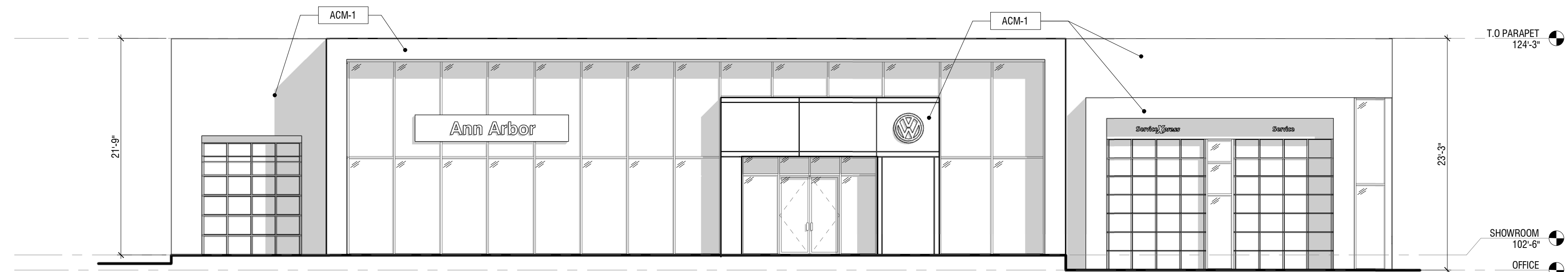

2 WEST ELEVATION - NEW
SCALE 1/8" = 1'-0"

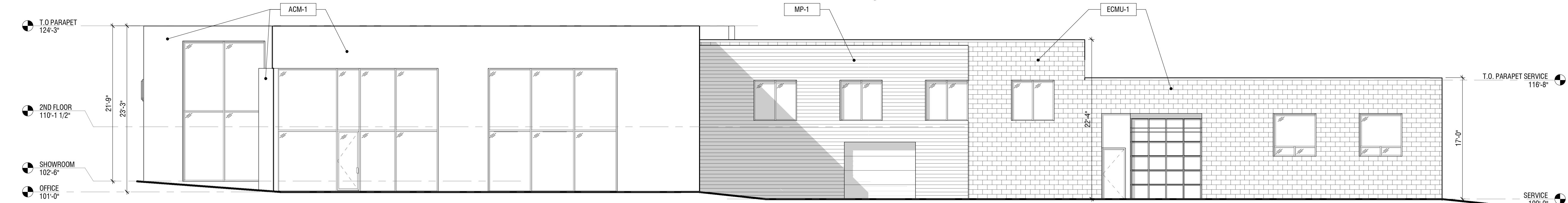

1 SOUTH ELEVATION - NEW
SCALE 1/8" = 1'-0"

GERMAIN
VOLKSWAGEN OF ANN ARBOR
2575 S. STATE ST, ANN ARBOR, MI

Set

Drawings

- Preliminary 09 / 18 / 13
- Bid Set
- Permit Set
- Construction

Revisions

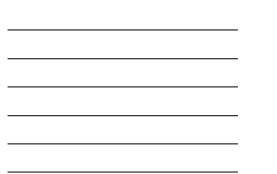

ARCHITECTURAL ALLIANCE
11000 E. GRAND AVENUE, SUITE 100
ANN ARBOR, MI 48106
P: 814.492.7500 T: 814.492.5000 I: www.a2a.com

Project Number
A13-034

Sheet Title
ELEVATIONS NEW - VOLKSWAGEN

Sheet Number





City of Ann Arbor

PLANNING & DEVELOPMENT SERVICES — PLANNING DIVISION

301 East Huron Street | P.O. Box 8647 | Ann Arbor, Michigan 48107-8647

p. 734.794.6265 | f. 734.994.8312 | planning@a2gov.org

APPLICATION FOR MODIFICATIONS FROM CHAPTER 62 (LANDSCAPE AND SCREENING)

See www.a2gov.org/planning for submittal requirements.

TO: Ann Arbor City Planning Commission

We, the undersigned, respectfully petition the City Planning Commission or City Council to approve these modifications from the landscape and/or screening requirements of Sections 5:602, 5:603, 5:604 or 5:606 of Chapter 62, as they relate to the property hereinafter described.

A. Project Information

(Give name of site plan project and tax code number of property)

GERMAIN MOTORS

09-12-04-300-056

B. Petitioner Information

The petitioner(s) requesting the modifications are:

(List petitioners' name; address; telephone number; and interest in the land; i.e., owner, land contract, option to purchase, etc.)

WASHTENAW ENGINEERING COMPANY

3526 W. LIBERTY RD, SUITE 400, ANN ARBOR, MI 48103

734-761-8800

AGENT FOR OWNER

Also interested in the petition are:

(List others with legal or equitable interest)

CAR GER MI ANN ARBOR LLC

C. Modification Request

The petitioner requests approval to modify the above landscape and/or screening requirements in the following ways (if necessary, attach additional page):

Section 5:602, Paragraph 2d

TOTAL OF 95 INTERIOR UVA TREES VERSUS 103 REQUIRED

Section 5:602, Paragraph 2g

NO LANDSCAPE ISLANDS ARE DEPRESSED

D. Standards for Approval

Flexibility in the application of the landscape and screening regulations may be allowed if certain standards are met. The modifications must be consistent with the intent of Chapter 62; be included on a site plan and in a motion approved by the City Planning Commission or City Council; and be associated with specific site conditions as listed in Section 5:608(2)(c).

1. What are the specific site conditions that necessitate this request and how do they warrant the modifications of Chapter 62 requirements? (See Section 5:608(2)(c)) List relevant subsection and explain how and to what extent the modifications are justified.

- INTERIOR ISLAND STEEP SLOPES AND SOILS MAKE PLANTING ADDITIONAL TREES
IN LARGE INTERIOR ISLAND IMPRACTICAL. INTERIOR TREE COUNT WILL BE SHORT BY 8.
- MOST OF THE ISLANDS ARE EXISTING ISLANDS WITH ESTABLISHED, HEALTHY TREES.
EXISTING UTILITY LINES PASS UNDER MANY OF THE PROPOSED NEW ISLANDS, MAKING
GRADING OF A DEPRESSED ISLAND DIFFICULT. OTHERS HAVE TOO MUCH SLOPE TO
PROVIDE ANY SIGNIFICANT WATER STORAGE.

2. How does the proposal meet the spirit and intent of Chapter 62? (See Section 5:600)

- INTERIOR ISLAND IS CURRENTLY VEGETATED BY VOLUNTEER TREES WHICH ARE NOT
OVER 6" DBH BUT ARE GROWING ON POOR SOILS. VISUAL APPEARANCE OF ISLAND IS
FULL COVERAGE SO REMOVING THEM IN ORDER TO PLANT 9 ADDITIONAL TREES WOULD
BE COUNTER PRODUCTIVE.
- THE SITE'S STORM WATER DETENTION SYSTEM IS SIZED APPROPRIATELY FOR THE
SITES EXISTING AND PROPOSED SURFACES WITHOUT ANY CHANGES.
- ALL ISLANDS WILL BE ATTRACTIVELY LANDSCAPED AND PROVIDE A CONSISTANT,
ATTRACTIVE LOOK FOR THE CAMPUS.

The undersigned states he/she is interested in the property as aforesaid and that the foregoing statements are true and correct to the best of his/her knowledge and belief.

Dated: 9/30/13

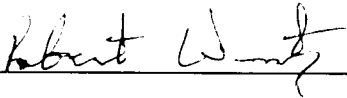
Signature: 

ROBERT WANTY

WASHTENAW ENGINEERING CO.

3526 W. LIBERTY RD, SUITE 400

(Print name and address of petitioner)

ANN ARBOR, MI 48103

STATE OF MICHIGAN)
) ss:
COUNTY OF WASHTENAW)

On this 30 day of SEPTEMBER, 2013 before me personally appeared the above named petitioner(s), who being duly sworn, say that they have read the foregoing petition and by them signed, and know the contents thereof, and that the same is true of their knowledge, except as to the matter therein stated to be upon their information and belief, and as to those matters they believe it to be true.

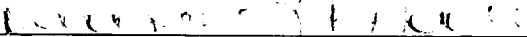
Signature: 

DEBORAH L MOORE

(Print name of Notary Public)

My Commission Expires: 7/22/2014

ACTING IN THE COUNTY OF WASHTENAW